

# ASSEMBLY GUIDE

PAVE N' TRAIL

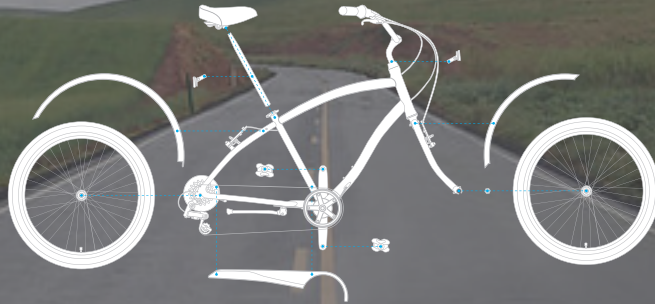

SIXTHREEZERO





# OUR COMMITMENT

We want you to love your bike as much as we do.  
If you run into any issues, no matter how small,  
let us know and we'll take care of it.

SIXTHREEZERO

[THETEAM@SIXTHREEZERO.COM](mailto:THETEAM@SIXTHREEZERO.COM)

310.982.2877

# MEET JACOB, OUR MECHANIC

Need assembly, repair, or installation assistance? He's your guy!  
Want live help? Call or email to schedule an appointment.



[MECHANICS@SIXTHREEZERO.COM](mailto:MECHANICS@SIXTHREEZERO.COM)

310.982.2877



A NOTE FROM  
OUR MECHANIC

Welcome to the sixthreezero experience. Now for the fun part... the assembly.

I know, I know, we've all had to assemble something we've bought before - a tv stand, coffee table, possibly a grill or even a bike a time or two before. It's never fun, it never goes well, you always lose a nut or a screw and by the time you're done, you'd rather destroy whatever it is you've bought than actually use it. Well, I'm here to make sure that doesn't happen.

Assembly of a bike can be a fun, engaging, learning experience. Call up a friend, ask your spouse or child, don't

rush, and enjoy the process. Part of the fun in building your bike is telling people "I built it all by myself." I build bikes almost everyday and I always learn something new. I enjoy the process of building something from the ground up, and I hope you will too.

The instructions were written and designed by me, so if you have any suggestions please let me know!

Good luck,

A handwritten signature in black ink that reads "JACOB". The letters are stylized and connected, with a prominent flourish at the end of the word.

MECHANIC / SIXTHREEZERO

# **TOOLS YOU'LL NEED**

Creating something wonderful with your own hands is basically the best feeling ever. We want you to have fun building your new bike, so there's only a few things you need to get started.



**SCISSORS**  
(use to cut zip ties)



**15MM CRESCENT WRENCH**  
or use the multi-tool provided



**MALLET OR  
HAMMER**



**4, 5, AND 6MM  
ALLEN KEY**



**PHILLIPS HEAD  
SCREWDRIVER**



**SCHRADER VALVE  
BICYCLE PUMP**



**BICYCLE OR  
AUTO GREASE**  
recommended



**2  
PENNIES**

---

# WHAT'S IN THE BOX?

Lay out all the parts in front of you.  
Make sure you have all the parts before getting started.

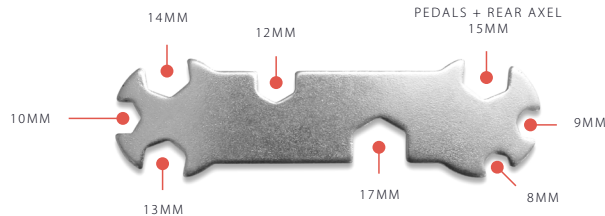



**HANDLE BAR / FRAME / REAR  
WHEEL AND REAR RACK SET-UP**  
seat post is zip-tied to frame



**QUICK RELEASE  
FRONT WHEEL**



**FRONT AND REAR  
REFLECTORS**

---



**ASSEMBLY  
GUIDE**

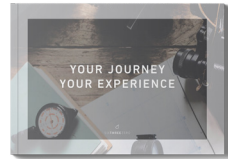

**EXPERIENCE  
BOOKLET**



**MULTI-TOOL**



**4, 5, AND 6MM  
ALLEN KEYS**







**PEDALS**



**SEAT**  
attached to seat tube



**QUICK RELEASE  
SKEWER**



**HARDWARE**  
pre-installed

---

---

# **BIKE PARTS REFERENCE GUIDE**

All the names of all the parts for your bike, all in one place.  
Keep this handy during assembly, and everything will go just fine.



QUICK RELEASE SKEWER



PEDALS



SEAT WITH SEATPOST

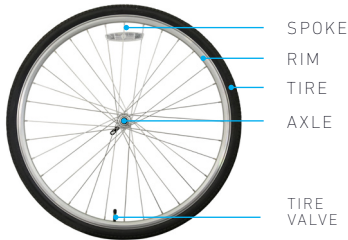

# FRONT WHEEL + REAR RACK

Parts required:



QUICK RELEASE  
FRONT WHEEL



FRAME, REAR RACK  
+ REAR WHEEL



QUICK  
RELEASE SKEWER

Tools you'll need:



(4) 4MM ALLEN  
KEY SCREWS  
**(pre-installed)**



4MM  
ALLEN KEY



5MM  
ALLEN KEY

# 01

Spin the front fork so that the brakes are pointing forward. Turn the handlebars to match the Correct Image so that the cables don't loop around the headtube.

## INCORRECT

The brakes are behind the fork.

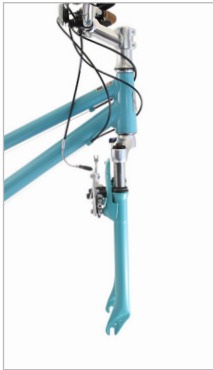

## CORRECT

The front brake is facing away from the bike body.



# 02

Pinch front brake arms, pulling the metal tubing up and out until it is disengaged and the brake arms are open.

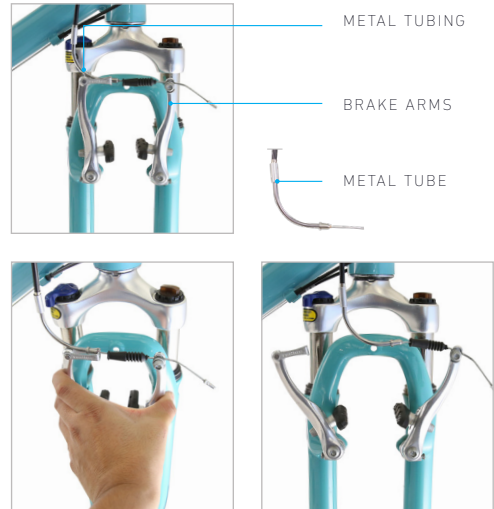

# 03

Locate the arrow on the wall of the tire and position the tire like the image below. With the arrow pointing forward, insert the wheel into the fork dropouts. The cone nuts will fall inside of the fork.

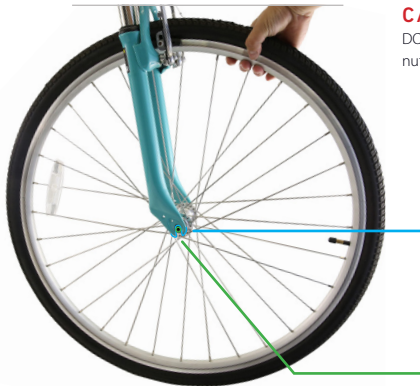

### CAUTION

DO NOT untighten axle nuts on the front wheel.

FORK DROPOUTS

AXLE NUTS

# 04



5MM ALLEN KEY

Use a 5mm multi-tool to loosen the front brake pads and rotate them horizontally if needed. The front brake pads will align to the side of the rim. Retighten them.

Reattach the brake arms by connecting the metal tube as shown.

We will revisit this step in the Brake Assembly section.





# 05



All of the components for the quick release skewer are attached out of the box.



Unscrew **QR5** and remove **QR4**. Do not remove **QR2** and **QR3** from the quick release handle **QR1**.

## NOTE

Quick release skewer must be installed correctly to avoid bicycle damage and/or injuries.

# 06

Insert the quick release skewer through the hub opening on either side of the wheel, as shown below.

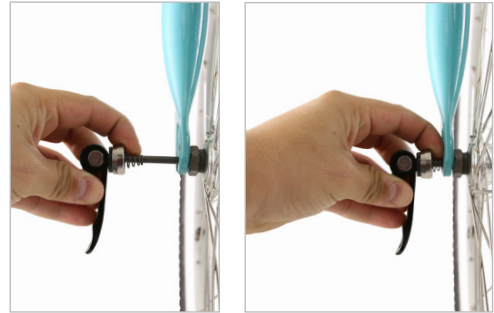

Slide quick release skewer completely through the hub.

# 07



Place **QR4** on the open side of the quick skewer, with the smaller end pointing inward.



# 08

Making sure the wheel is straight by pulling the wheel completely up against the fork. Attach **QR5** to **QR1** by compressing the spring completely. Hold the quick release lever in place and tighten **QR5** lightly.



# 09



Lift the lever up towards the fork. If the lever does not lock in place smoothly, loosen **QRS** slightly and try again. It will take a small amount of strength, but that is normal.



## NOTE

The lever at a 90° angle, should be tight enough to feel resistance when you close the lever. Make sure the front wheel is securely tightened and properly aligned so there are no issues when you assemble the brakes.

# 10

Once the front wheel is secured, lower the kickstand and locate the front fender.



# 11



4MM  
ALLEN KEY



(2) 4MM ALLEN  
KEY SCREWS



REAR  
RACK

(Locked at rear rack mount)

Align the front arms of the rear rack to the eyelets on the frame below the seat. Use a 4mm allen key to tighten the screws and attach the rear rack to the frame.



# 12



4MM  
ALLEN KEY



(2) 4MM ALLEN  
KEY SCREWS



REAR  
RACK

(Locked at rear rack mount)

Install the bottom rear rack arms to the frame using the 4mm allen screws. Tighten with a 4mm allen key. Repeat on both sides.



# HANDLEBAR, SEAT + PEDALS



PEDALS



5MM  
ALLEN KEY



15MM  
MULTI-TOOL



BICYCLE  
PUMP



HANDLEBAR



SEAT ATTACHED  
TO SEAT TUBE



PHILLIPS  
SCREWDRIVER



BICYCLE OR  
AUTO GREASE

# 13

---

Your bike is equipped with a “threadless stem”. It clamps to the outside of the steerer tube.



## NOTE

These bolts are designed to be tightened to correct torque. If you don't have access to a torque wrench, we suggest to visit your local bike shop for proper tightening. If you decide to tighten the screws without a torque wrench, make sure to tighten the bolts until they are snug. Do not overtighten. Bolts that are too loose can move and fatigue. Bolts that are too tight can stretch and deform. Either mistake can lead to a sudden failure of the bolt, causing you to lose control and fall.

# 15

---



Loosen the top cap of the fork steerer with a 5mm Allen key and remove the top cap and bolt. Do not miss place these components.





# 16

---



Loosen the stem clamp bolts with a 5mm Allen key before twisting the stem to face forward. Align the stem to be in line with the front wheel.



# 17

Now tighten the stem clamp bolts evenly with the handlebar assembly facing directly forward.



## NOTE

These bolts are designed to be tightened to correct torque. If you don't have access to a torque wrench, we suggest to visit your local bike shop for proper tightening. If you decide to tighten the screws without a torque wrench, make sure to tighten the bolts until they are snug. Do not overtighten. Bolts that are too loose can move and fatigue. Bolts that are too tight can stretch and deform. Either mistake can lead to a sudden failure of the bolt, causing you to lose control and fall.

# 18



After making sure that the stem bolts are properly tightened, use a 5mm allen key to re-install the top cap.



# 19



Loosen the bolts on the handlebar faceplate using a 6mm Allen key.



# 20



Place handlebar between the stem and faceplate ensuring that the ridges are centered and covered by the faceplate. This will ensure that the handlebars are centered. Using a 6mm allen key, tighten the stem faceplate bolts evenly and secure the handlebars in place.



## NOTE

A good way to double check yourself would be to put your weight down on the handlebars. If they don't move, then they are secured properly.

# 21



PHILLIPS  
SCREWDRIVER



FRONT  
REFLECTOR

Adjust the position of the front reflector by loosening the screw on the bracket.



Straighten the reflector so that it points forward.

# 22



BICYCLE OR  
AUTO GREASE

Our suspension seat post doesn't need any adjustment and comes ready to use.

Open the quick release lever. Apply grease to seat post. Insert into seat post tube until the top of the seat is leveled to your waist. The seat post must be past the minimum insertion mark.

Rotate and tighten the quick release lever handle until finger tight. Place the lever in your palm and close the quick release lever.



# 23



BICYCLE OR  
AUTO GREASE



15MM  
MULTI-TOOL



PEDALS

Apply grease to the threading on both pedals.

Select the pedal stamped **R** (located on the tip of the threading) and locate the right side of the bike (with the chain and chain guard).

Align threading with the right crank arm, and turn the pedal clockwise to tighten it.

Locate the pedal stamped **L** and align with the left crank arm. The left side pedal is reverse-threaded, tightening in a counterclockwise direction.

We recommend hand tightening initially and following up with a 15mm wrench to fully tighten down the pedals.

## RIGHT PEDAL



## LEFT PEDAL



## 24



BICYCLE PUMP

Pump air into the tires to **PSI40-65MAX**, as recommended on the sidewall of the tire.



## 25

Sit on the bike and check the angle formed by your knee. If your knee forms the incorrect angle, use the seat post clamp lever to raise the seat until you have a subtle bend or achieve a comfortable height.

**CORRECT**



**INCORRECT**



**NOTE**

The images above use a different bicycle, but the instructions are the same.



# BRAKE ASSEMBLY

## DIAGRAM

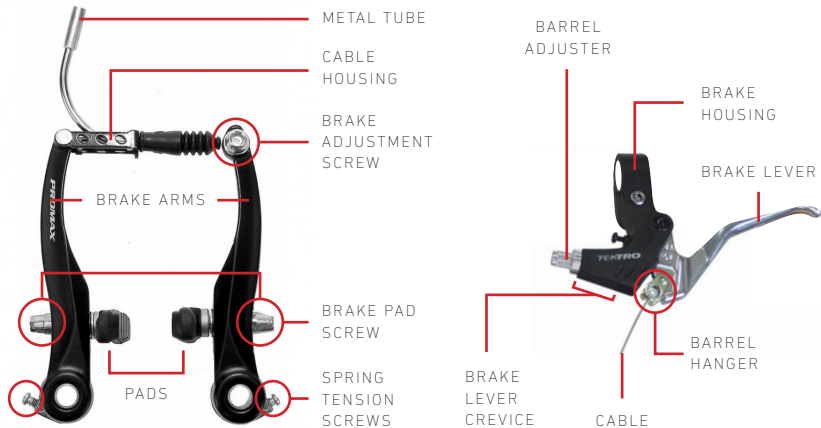

## TOOLS REQUIRED

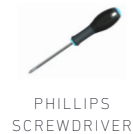

## NOTE

Only follow steps 1-9 if your brake cable is not attached to the bicycle.

If your brake cable is attached, skip to step 10.



ATTACHED  
BRAKE CABLE

## 01

---

There are two ends to the brake cable.

One end has a barrel attached, while the other end has an open piece of cable.

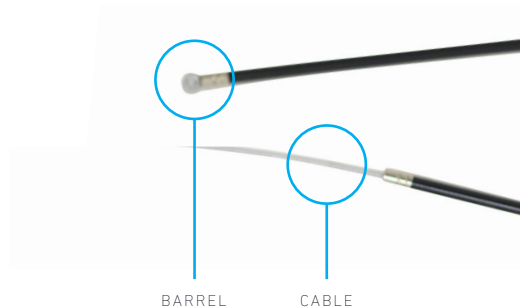

BARREL

CABLE

**02**

Attach the brake cable to the brake lever by squeezing the lever and inserting the barrel into the barrel hanger.



**03**

Pull on the cable and slide it through the narrow crevice that runs along the brake lever.

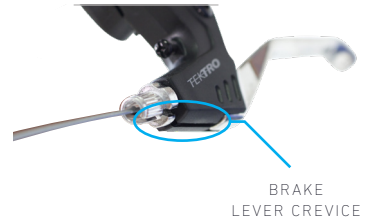

**04**

Slide the cable housing up toward the brake lever until it fits snug inside the barrel adjuster.



**05**

Turn the lock ring on the barrel adjuster clockwise, tightening the barrel to prevent any loose movement.

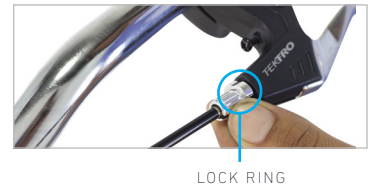

# 06

Insert the open end of the brake cable into the larger end of the metal tube.

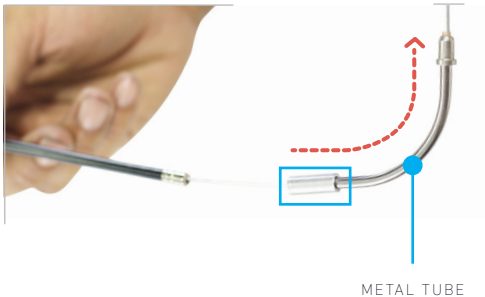

# 07

Slide the metal tube up the brake cable until the housing fits snugly into the cable housing.

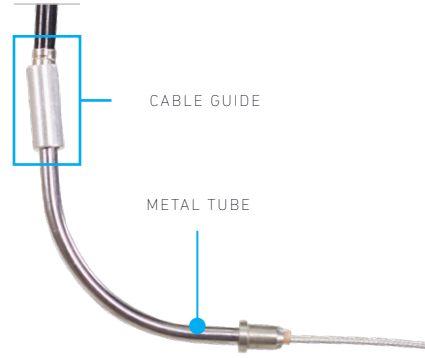

# 08

Slide the exposed end of the metal into the metal tube hanger, located on the left brake arm. Make sure the metal tube is hooked securely inside the hanger.

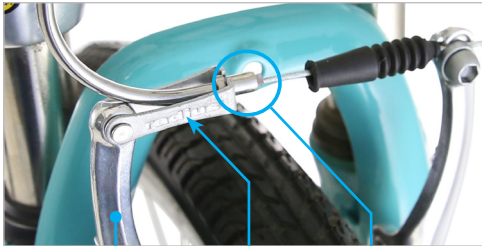

LEFT  
BRAKE ARM

METAL TUBE  
HANGER

END OF  
METAL TUBE

# 09



5MM ALLEN KEY

Using a 5mm Allen key, loosen the brake cable adjustment screw. Slide remaining brake cable between the right brake arm and the adjustment screw.

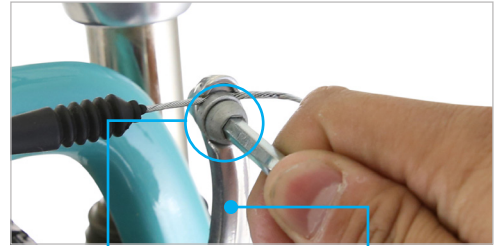

BRAKE ADJUSTMENT  
SCREW

RIGHT BRAKE ARM

# 10

Pull the cable outward, reducing the distance between the brake pads and the rim by about 1/4 inch on both sides. Retighten the adjustment screw.



CABLE

# 11



5MM  
ALLEN KEY

Make sure the pads are evenly lined up with the rim. If the pads rub against the tire, they are too high; if they don't make full contact with the rim when braking, they are too low.

Adjust the positions by holding the brake pad with one hand and loosening the nut on the back with a 5mm Allen key.



ADJUST WITH  
5MM ALLEN KEY

# 12

---

If one pad seems to run against the rim while the other still has plenty of space, you will need to center the brakes. To do this, adjust the spring tensioner screws located at the base of each brake arm.

Tightening the screw on the right brake arm pushes the right brake pad away from the rim, and the left brake pad towards the rim.

Loosening the right screw allows the right brake pad to move closer to the rim, and the left brake pad away from the rim.



# 7 SPEED DERAILLEUR TUNING

## DIAGRAM



BARREL CABLE  
ADJUSTER

H LIMIT SCREW

L LIMIT SCREW

CABLE  
ADJUSTMENT  
BOLT

## TOOLS REQUIRED



PHILLIPS  
SCREWDRIVER



9MM  
MULTI-TOOL



# 01

To adjust the rear derailleur, first twist the shifter until the number **7** is highlighted on the shift knob.



# 02

Rotate pedals until the chain falls into the smallest cog.



# 03

Turn the barrel adjuster located on the rear derailleur clockwise until it stops.



BARREL  
ADJUSTER

# 04

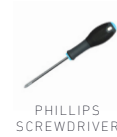

PHILLIPS  
SCREWDRIVER

If the chain still hasn't reached the smallest cog, then you will need to adjust the "High Gear" limiting screw located on the derailleur (indicated by the letter **H**).

With a Phillips screwdriver, gradually turn the screw counterclockwise 1/4 turn at a time while rotating the pedal until the chain falls onto the smallest cog.



## NOTE

The "High Gear" limiting screws are very sensitive. We recommend using only 1/4 turn at a time, in case you have to revert back to it's original position.

## 05



Now adjust the cable tension, which controls how your bike will shift. Using a 9mm crescent wrench or the multi-tool, loosen the cable adjustment screw and pull on the cable. While keeping tension on the cable, tighten the cable adjustment screw.



## 06

Rotate the pedals and try to shift between gears. If it doesn't shift from 7th to 6th gear in one click, then the cable needs to be tightened. To tighten the cable, twist the barrel adjuster counterclockwise 1/4 turn at a time until it is able to shift from 7th to 6th gear in one click.

Shift through the gears from 7th to 1st, then back from 1st to 7th. If the gears feel sluggish when shifting from 7th to 1st, tighten the cable by turning the barrel adjuster counterclockwise. If shifting feels fine from 7th to 1st, but sluggish from 1st to 7th, loosen the cable by turning the barrel adjuster clockwise.

Continue to adjust the derailleur cable until you are able to shift between each gear with a single click.



### NOTE

Each gear should shift with a corresponding "click" sound.

# 21 SPEED DERAILLEUR TUNING

DIAGRAM

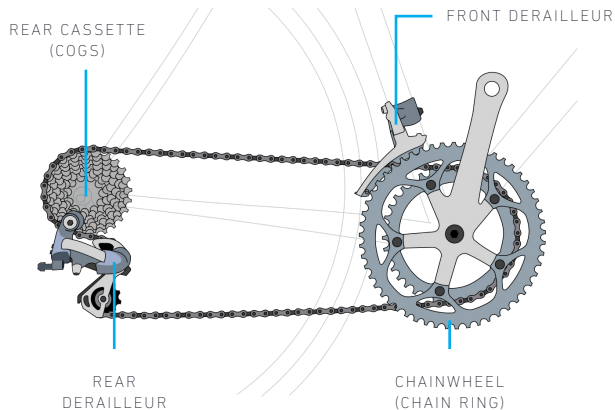

HAVING TROUBLE? WANT LIVE HELP? CALL 310.982.2877 OR EMAIL [INFO@SIXTHREEZERO.COM](mailto:INFO@SIXTHREEZERO.COM).

## NOTE

We tune every bike before packaging, but I would still recommend checking the tuning. It's possible that they may need to be readjusted after being shipped to you. These instructions are designed to help if your bike needs a little extra work.

If you don't feel comfortable working on your bike, we suggest taking it to your local bike shop for final assembly.

## TOOLS REQUIRED



PHILLIPS  
SCREWDRIVER



5 MM  
ALLEN KEY



MALLET OR  
HAMMER

## INDEX SHIFTER

The front and the rear shifters are called "Index" shifters. This means it has set levels for each gear. For every click given, the shifter moves up or down a one gear.

### FRONT

1st, 2nd, and 3rd gears.

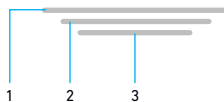

### REAR

1st, 2nd, 3rd, 4th, 5th, 6th, and 7th gears.

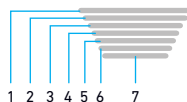

With 7 gears in the rear and 3 in the front, you are able to shift into 21 different gear combinations.

## CAUTION

Please be careful with the derailleur cage as it has tension that causes the cage to pull back into the frame when attached to the shifting cable.



## 2 PERSON ASSEMBLY RECOMMENDED BUT NOT REQUIRED

We recommend you have a helper with you. It's not necessary, but it would make shifting in these steps a whole lot easier.

Besides, are you going to get up and get your own tools?

Let's start.

## DERAILLEUR POSITION

# 01

---

Check your bike's tuning by taking it for a test ride. Shift the front derailleur up and down to check each gear while riding. If you hear any rubbing coming from the chain hitting the derailleur in any of the gears, you will need to tune the front derailleur.



# 02

---



2 PENNIES

Begin by shifting the front derailleur to 2nd gear. Lift the chain and pull the cage away from the bike to place a penny in between the outer cage and the largest chainwheel. If you can fit two pennies, then your front derailleur is too high. If the penny fits snugly in between the outer cage and the chainwheel, you can move to step 4.

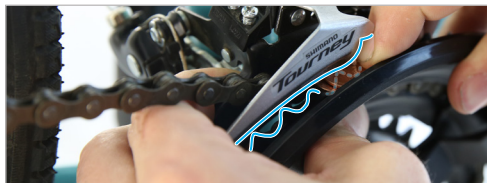

# 03



Untighten the clamp with a 5mm Allen key a quarter turn at a time until you are able to tap the derailleur slightly up and down without it falling completely down the seat tube. While still pulling the cage forward, grab a penny and place it above the largest chainwheel. Adjust the height of the derailleur cage so it sits above the penny. With a mallet/hammer and the allen key, you can slightly tap the derailleur up or down based on its original position. Reference the **bottom right image as an example**. Now tighten the cage in place with a 5mm Allen key.

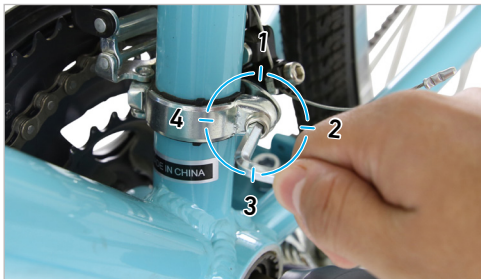

# 04

Once the height is set, we must check the angle of the cage. Lift the chain and pull the cage forward and view the cage from above. The inside of the outer cage plate must be parallel to the largest chainwheel. If your outer cage plate is parallel to the largest chainwheel, you can move to step 6.

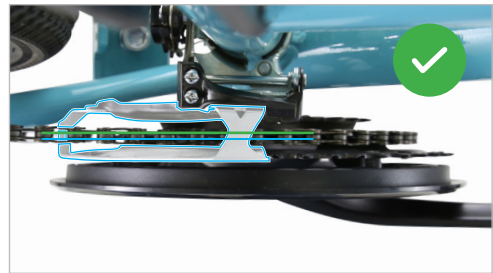
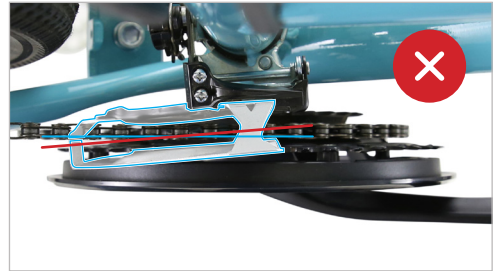
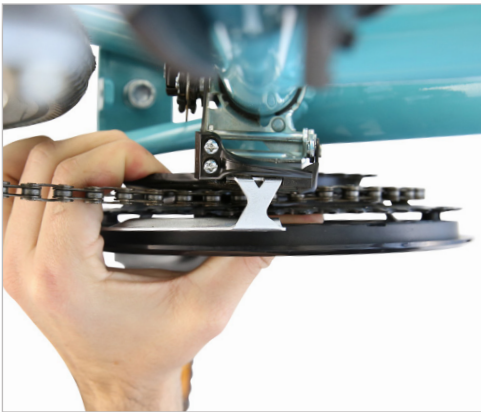



# 05



5 MM  
ALLEN KEY



MALLET  
OR HAMMER

If your outer cage plate is NOT parallel to the largest chainwheel, untighten the clamp a quarter turn at a time until you are able to slightly move the derailleur.

Based on the angle, tap on the back or the front of the cage after every turn until it moves slightly.

Tap the cage left or right to align the cage plate and the largest chainwheel. Recheck the angle to make sure that they are parallel. Now tighten the cage in place with a 5mm Allen key.

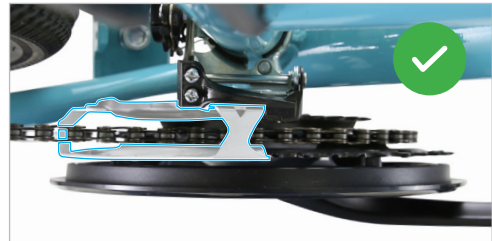
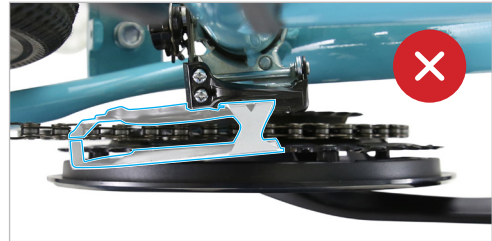

## NOTE

If you untighten the derailleur too much, it will potentially offset the height of the derailleur causing a need to repeat step 5.

## NOTE

Derailleurs work off of tension, and this is the reason that they are designed with High and Low Limiter screws. The High and Low Limiters essentially act as boundaries so that no matter how much tension you put into or take off the shifter cable, the derailleur will not go past the largest or smallest gears. The High (H) screw is the limiter for the largest gear, and the Low (L) screw is the limiter for the smallest gear.

### COUNTERCLOCKWISE

Turning the **L** & **H** counterclockwise shortens the range where the derailleur cage can travel.

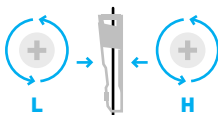

### CLOCKWISE

Turning the **L** & **H** clockwise increases the range where the derailleur cage can travel.

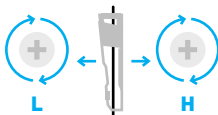

## LIMITER SCREWS

# 06

Now, let's check the H limit screw. Begin by shifting the derailleur to 3rd gear. While turning the pedals, shift into 3rd gear. If the chain does not fall off the largest chain-wheel when shifting into 3rd gear, the H limit screw is close to proper positioning.



# 07



Reference the bottom left image below to check if the derailleur is properly adjusted. If it matches the images, please move forward to Step 8. Looking through the front of the derailleur cage, decide whether the chain is too close to the inner or outer cage plates. If the chain is too close to the outer cage plate, turn the H screw clockwise a quarter turn at a time until it is centered. If the chain is too close to the inner cage plate (closer than the outer cage plate or it is rubbing), then turn the H screw counter-clockwise a quarter turn at a time until it is centered.

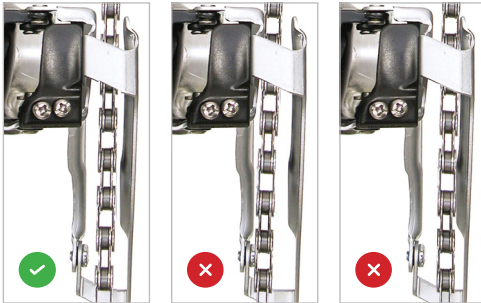

# 08

Now, let's check the L limit screw. Begin by shifting the derailleur to 1st gear. While turning the pedals, shift into 1st gear. It may take more than 1 click. If the chain does not fall off the smallest chainwheel after shifting from 2nd to 1st, the L limit screw is close to proper positioning.

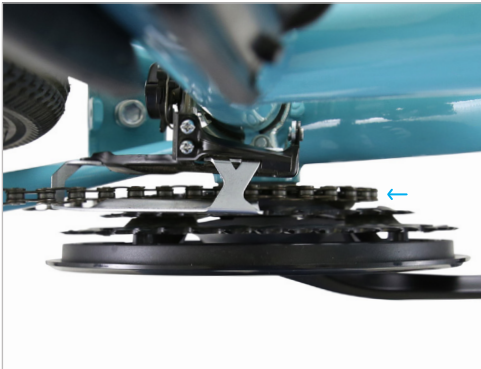

# 09

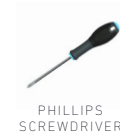

PHILLIPS  
SCREWDRIVER

Reference the image below on the left, if the chain is centered in between the inner and outer cage plates, you can move on to step 10, Micro Adjustments. If the chain is NOT centered in between the inner cage, you will need to use a Phillips head to center the inner walls of the cage to the chain. Looking overhead at the cage and inspect its current position.

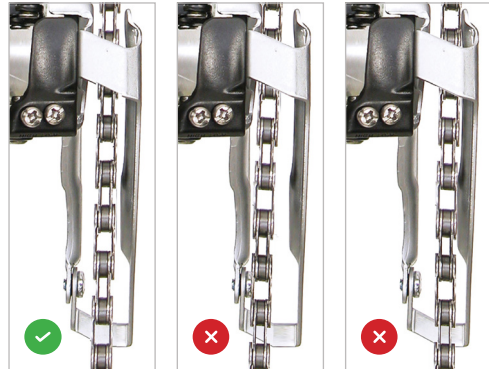

# 10



PHILLIPS  
SCREWDRIVER

Based on the screws original position, take note of the amount of quarter turn rotations given in either direction to the L screw, until the inner and outer cage plates are centered. If the outer cage plate is too far in and rubbing against the chain, you have to turn the L screw counter-clockwise. If the inner cage plate is too far out and rubbing against the chain, you have to turn the L screw clockwise.



## CABLE TENSION AND SHIFTING

# 11

Now that you have adjusted the limiter screws, let's check each gear to make sure that the derailleur is shifting correctly. Shift from 1st gear to 2nd, 2nd to 3rd gear, and from 3rd to 1st gear. If you can pedal the bike in each gear without hearing rub, and it's shifting up and down without resistance or lag, the front derailleur is properly adjusted. If not, we will need to do some minor adjustments with the barrel adjuster.



# 12

Locate the barrel adjuster located on the front shifter where the cable comes out of the shifter. Note/Explanation: The barrel adjuster will change the amount of tension on the shifting cable. This helps the derailleur move up and down the gears. Turn the barrel adjuster counter-clockwise a quarter turn at a time while pedaling the bike. Keep checking for rub/lag on each gear until it disappears. If the rub/lag persists, please feel free to contact one of our mechanics to help you troubleshoot this last step.



## FORK SUSPENSION

# 01

Your bike is equipped with front fork spring suspension.

The position of blue lever indicates whether the front fork is locked or unlocked.

The front fork is locked if the blue lever is highlighting the color red. If the blue lever is highlighting the color green, the front fork is unlocked allowing for damped and cushioned ride.

**UNLOCKED**



**LOCKED**



## 02

There is no need to adjust the tension of the spring. If you do decide to add or relieve tension, take note on the amount of twists and/or rotations in any given direction that it took to get to your preferred riding stiffness or softness.



## 03

Your bike should be ready to ride at this point. Time to enjoy the ride! If you have/had any trouble at all, please feel free to contact our team at:

(310) 982-2877

theteam@sixthreezero.com

# **SURVEY**

---

Tell us about your assembly experience. If you have/had any trouble at all or didn't, and would like to leave feedback and help us improve our assembly instructions you can.

Type this URL into your browser:

[goo.gl/kdJeJx](https://goo.gl/kdJeJx)



WATCH ASSEMBLY VIDEOS ON OUR YOUTUBE CHANNEL, [HTTPS://SIXTHREEZERO.COM/PAGES/ASSEMBLY](https://sixthreezero.com/pages/assembly)

# CONGRATULATIONS

You did it! Time to take your brand new bike for a spin.  
Still have questions? We're happy to help.  
Want to share your journey with us? We're happy about that, too.



SIXTHREEZERO

THETEAM@SIXTHREEZERO.COM

310.982.2877





SIX**THREE**ZERO  
LOS ANGELES, CA

THETEAM@SIXTHREEZERO.COM  
310.982.2877