

EBIKE

ASSEMBLY GUIDE

EVRYJOURNEY 1, 3, 7, & 21 SPEED

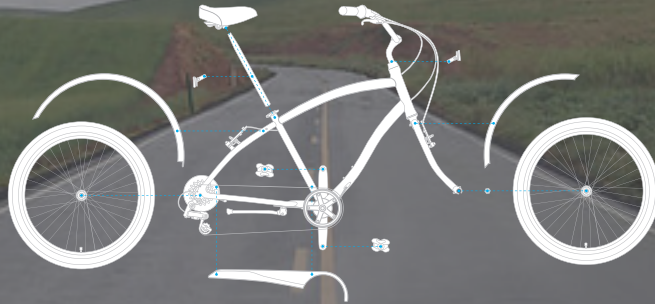

SIXTHREEZERO



OUR COMMITMENT

We want you to love your bike as much as we do.
If you run into any issues, no matter how small,
let us know and we'll take care of it.

SIXTHREEZERO

THETEAM@SIXTHREEZERO.COM

310.982.2877

MEET JACOB, OUR MECHANIC

Need assembly, repair, or installation assistance? He's your guy!
Want live help? Call or email to schedule an appointment.



MECHANICS@SIXTHREEZERO.COM

310.982.2877

A NOTE FROM
OUR MECHANIC

Welcome to the sixthreezero experience. Now for the fun part... the assembly.

I know, I know, we've all had to assemble something we've bought before - a tv stand, coffee table, possibly a grill or even a bike a time or two before. It's never fun, it never goes well, you always lose a nut or a screw and by the time you're done, you'd rather destroy whatever it is you've bought than actually use it. Well, I'm here to make sure that doesn't happen.

Assembly of a bike can be a fun, engaging, learning experience. Call up a friend, ask your spouse or child, don't

rush, and enjoy the process. Part of the fun in building your bike is telling people "I built it all by myself." I build bikes almost everyday and I always learn something new. I enjoy the process of building something from the ground up, and I hope you will too.

The instructions were written and designed by me, so if you have any suggestions please let me know!

Good luck,

A handwritten signature in black ink that reads "JACOB". The letters are stylized and connected, with a prominent flourish at the end of the word.

MECHANIC / SIXTHREEZERO

TOOLS YOU'LL NEED

Creating something wonderful with your own hands is basically the best feeling ever. We want you to have fun building your new bike, so there's only a few things you need to get started.



SCISSORS
(use to cut zip ties)



**8, 10, 13, AND 15MM
CRESCENT WRENCHES**
or use the multi-tool provided



**4, 5, AND 6MM
ALLEN KEY**



**PHILLIPS HEAD
SCREWDRIVER**



**SCHRADER VALVE
BICYCLE PUMP**



**2
PENNIES**



WHAT'S IN EACH BOX?

Lay out all the parts in front of you.
Make sure you have all the parts before getting started.

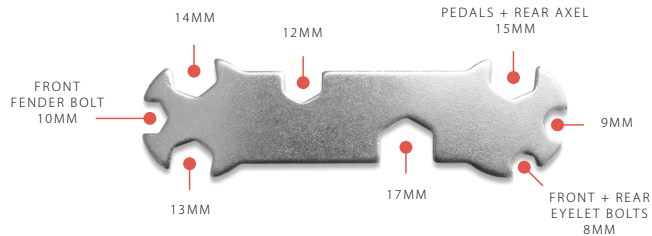



BATTERY



FRONT REFLECTOR
pre-installed



**QUICK RELEASE
FRONT WHEEL**



BATTERY CHARGER



**HANDLE BAR / FRAME / REAR
WHEEL AND REAR RACK SET-UP**
Seat post is zip-tied to frame



**FRONT FENDER
+ STRUT**
fender strut pre-installed

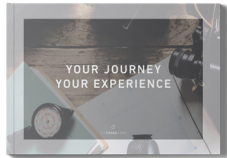

**EXPERIENCE
BOOKLET**



**ASSEMBLY
GUIDE**



MULTI-TOOL



**4, 5, AND 6MM
ALLEN KEYS**



PEDALS



LOCK NUT CAP



SEAT



**QUICK RELEASE
SKEWER**

BOX 3

BOX 4

BIKE PARTS REFERENCE

All the names of all the parts for your bike, all in one place.
Keep this handy during assembly, and everything will go just fine.



FRONT WHEEL, FENDER + REAR RACK

Parts required:



FRONT FENDER
+ STRUT



QUICK RELEASE
FRONT WHEEL



FRAME, REAR RACK
+ REAR WHEEL



QUICK
RELEASE SKEWER

Tools you'll need:



PHILLIPS
SCREWDRIVER



4MM
ALLEN KEY



10MM
MULTI-TOOL



(2) PHILLIPS
HEAD SCREWS
(pre-installed)



(2) WASHERS, NUT
AND LONG BOLT
(pre-installed)



(4) 4MM ALLEN
KEY SCREWS
(pre-installed)

WE STRIVE FOR PERFECT. ALTHOUGH IT 'S NOT ALWAYS POSSIBLE, WE NEVER LEAVE A RIDER BEHIND.

01

Spin the front fork so that the the handlebars are pointing inwards.

CORRECT

The front brake is facing away from the bike body.



INCORRECT

The brakes are behind the fork.



02

Pinch front brake arms, pulling the metal tubing up and out until it is disengaged and the brake arms are open.



03

Locate the arrow on the wall of the tire and position the tire like the image below. With the arrow pointing forward, insert the wheel into the fork dropouts. The axle nuts will fall inside the fork entry.



04

Reattach the brake arms by connecting the metal tube as shown.



05



All of the components for the quick release skewer are attached out of the box.



Unscrew **QR5** and remove **QR4**. Do not remove **QR2** and **QR3** from the quick release handle **QR1**.

NOTE

Quick release skewer must be installed correctly to avoid bicycle damage and/or injuries.

06

Insert the quick release skewer through the hub opening on either side of the wheel, as shown below.

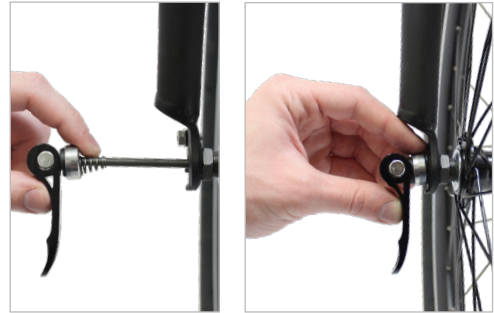

Slide quick release skewer completely through the hub.

07



Place **QR4** on the open side of the quick skewer, with the smaller end pointing inward.



08

Making sure the wheel is straight, attach **QR5** to **QR1** by compressing the spring completely. Hold the quick release lever in place and tighten **QR5** lightly.



09



Lift the lever up towards the fork. If the lever does not lock in place smoothly, loosen QR5 slightly and try again. It will take a small amount of strength, but that is normal.



NOTE

The lever should be tight enough to feel resistance at a 90° angle. Make sure the front wheel is securely tightened and properly aligned so there are no issues when you assemble the brakes.

10

Once the front wheel is secured, lower the kickstand and locate the front fender.



11



Align the fender struts with the eyelets on the fork, so that the fender tab is pointing upwards. Slide the fender up through the back of the front tire.

Use a Phillips head screwdriver and the 10mm multi-tool to remove then install the fender tab screw and nut.

NOTE

Order from front to back:
LONG BOLT, WASHER, FORK, FENDER TAB, WASHER, NUT.

Remove the screws from the fork eyelets.

FENDER TAB



12



PHILLIPS
SCREWDRIVER



(2) PHILLIPS
HEAD SCREWS
(pre-installed)

Attach the screws into the struts and eyelets.



13



4MM
ALLEN KEY



(2) 4MM ALLEN
KEY SCREWS
(pre-installed)



REAR
RACK

Align the front rear rack arms to the eyelets on the frame below the seat. Use a 4mm allen key to tighten the screws and attach the rear rack to the frame.

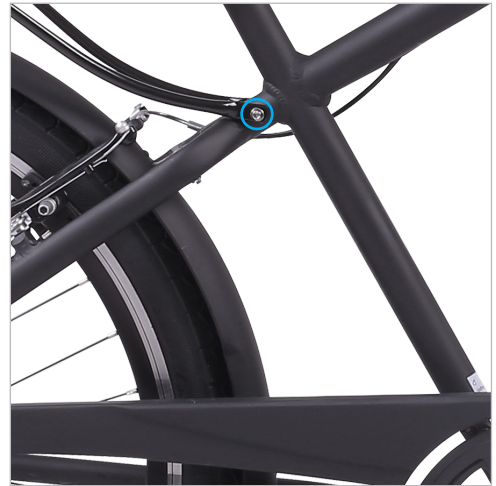

14



4MM
ALLEN KEY



(2) 4MM ALLEN
KEY SCREWS
(pre-installed)

Install the bottom rear rack arms to the frame in this order (from the frame out): Frame, fender strut, rear rack arms, and 4mm allen screws. Tighten with a 4mm allen key.



ORDER:

1. FRAME
2. FENDER STRUT
3. REAR RACK ARM
4. 4MM ALLEN KEY SCREW

NOTE

Repeat on both sides.

15



PHILLIPS
SCREWDRIVER



(2) PHILLIPS
HEAD SCREWS
(pre-installed)

Install the angled rear fender strut to the frame in this order (from the frame out): Frame, fender strut, and phillips head screws. Tighten with a phillips screwdriver.



ORDER:

1. FENDER STRUT
2. PHILLIPS HEAD SCREW

NOTE

Repeat on both sides.

HANDLEBAR, SEAT + PEDALS



HANDLEBAR



PEDALS



6MM
ALLEN KEY



BICYCLE
PUMP



LOCK
NUT CAP



SEAT



PHILLIPS
SCREWDRIVER



13MM + 15MM
MULTI-TOOL

15



LOCK NUT CAP



HANDLEBAR

Place the lock nut cap in between **ST1** and **ST2**.

Line up the stem, frame, and front wheel, then tighten the handlebar stem bolt.



ST1 STEM

LOCK NUT CAP

ST2 LOCK NUT/
HEAD TUBE

HANDLEBAR
STEM BOLT



NOTE

Straightening the stem, frame, and front wheel will ensure that your handlebars and wheel are properly aligned.



16



6MM
ALLEN KEY

Loosen handlebar adjustment bolt using the 6mm Allen key. Change the angle of the handlebars to your liking. Riders typically prefer their grips parallel to the ground.



17



PHILLIPS
SCREWDRIVER

Straighten the reflector so that it points forward.



Adjust the position of the front reflector by loosening the screw on the bracket.

18

Open seat post clamp. Holding the seat post firmly, insert into seat post tube until the top is level with your waist.

Close the seat post clamp lever.

CAUTION

Make sure not to drop seat post into the frame.



19



13MM
MULTI-TOOL

Place the seat onto the seat post, using the 13mm multi-tool to tighten the nuts under the seat.



20



PEDALS



15MM
MULTI-TOOL

Select the pedal stamped R and locate the right side of the bike (with the chain and chain guard). Align threading with the right crank arm, turning the pedal clockwise to tighten it.

Locate the pedal stamped L and align with the left crank arm. The left side pedal is reverse-threaded, tightening in a counterclockwise direction.

Hand tighten accordingly, then follow up by tightening both pedals with the 15mm multi-tool or crescent wrench.



21



BICYCLE PUMP

Pump air into the tires to **PSI40-65MAX**, as recommended on the sidewall of the tire.



22

Sit on the bike and check the angle formed by your knee.

If your knee forms the incorrect angle, use the seat post clamp lever to raise the seat until you have a subtle bend or achieve a comfortable height.

CORRECT



INCORRECT



HAVING TROUBLE? CALL 310.982.2877 OR EMAIL THETEAM@SIXTHREEZERO.COM

MECHANICAL DISC BRAKE ALIGNMENT

DIAGRAM



DIAGRAM

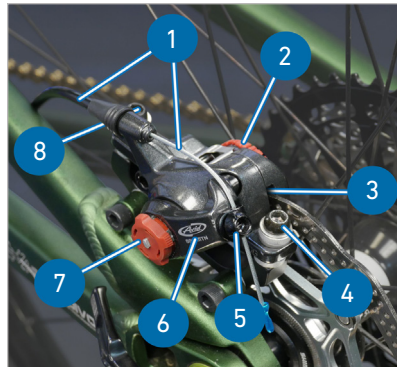

- 1 CABLE + HOUSING
- 2 ADJUSTERS
- 3 PADS
- 4 MOUNTING BOLTS
- 5 PINCH BOLT
- 6 LEVER ARM
- 7 ADJUSTERS
- 8 MOUNTING BOLTS

WE STRIVE FOR PERFECT. ALTHOUGH IT 'S NOT ALWAYS POSSIBLE, WE NEVER LEAVE A RIDER BEHIND.

01

Before beginning the caliper alignment process, it is important to check other components that could effect your brake adjustment are set correctly.

Ensure that the wheel is fully seated in the drop outs. This, in turn, ensures that the rotor is properly positioned in the caliper.

Elevate the bike, spin the wheel and inspect the rotor in the caliper. If the rotor shows a lot of lateral movement, it can be difficult or impossible to adjust the pads to not rub. The rotor will need to be trued or replaced.

Turn the barrel adjusters all the way counterclockwise at the lever and at the caliper if applicable.

Check that the lever arm is released and in its relaxed position by loosening the cable pinch bolt. This ensures full lever arm travel during braking.

Pull the cable tight so it is free of slack and tighten the cable pinch bolt.

NOTE

Be careful not to move the lever arm when tightening the pinch bolt. This is important because the lever arm only has a small amount of useful motion.

02

Begin by loosening the caliper mounting bolts. This allows the caliper to float.

Turn the inner pad adjuster all the way in (clockwise), then back off about 1/4 turn

Pull and hold the brake lever tight. This aligns the caliper body to the rotor.

Snug the caliper mounting bolts.

Release the brake lever. Back off the pad adjuster another 1/4 turn.



FINAL ADJUSTMENTS

03

These final adjustments apply to all mechanical disc brakes. The end goal is a caliper that is parallel to the rotor, with even gaps on each side and an adequate lever feel. Even though setting the pads against the rotor should theoretically have aligned the caliper correctly, it is common for further adjustments to be required.

Pull and release the brake lever a few times to check the clearance at the grip. Check that the lever travel feels adequate to slow and stop the bike. Typically, the pads should feel like they are contacting the rotor at a minimum of one-half the lever travel.

Make adjustments as necessary using the pad adjusters, moving the pads in and out evenly on both sides.



04

Spin the wheel and check for pad rub. If there is no pad rub, the alignment is complete — skip to **STEP 5**.

If the wheel slows quickly, or makes a rubbing noise, the pads need further adjustment. Inspect the alignment of the pads to the rotor. You may need to reorient the bike for a better view.

It is helpful to backlight the caliper body by shining a light on a piece of white paper or material. This makes the pad clearances easier to see:

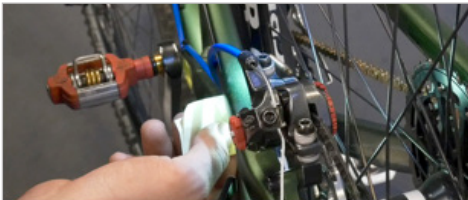

05

If the pads are not parallel to the rotor, the caliper body needs to be adjusted. Loosen one bolt, move the body slightly to the side that has no gap, snug the bolt and re-check the alignment. Keep in mind that making one adjustment may affect others.

If pads appear parallel, but there is still rubbing, loosen the pad adjuster on the side with pad rub in 1/4-turn increments until it is gone. Re-check the clearance at the lever and adjust as necessary.

For calipers with inner pad adjustments only, the procedure for adjusting outer pad clearance is different:

Loosen one of the mounting bolts, move the caliper a small amount toward the side that is rubbing, and re-slug the bolt.

Repeat these steps until the rubbing is eliminated.

Finish by fully tightening the pinch bolt and each mounting bolt. Typical torque specs are about 6 Nm for the mounting bolts and 4 Nm for the pinch bolt.

If you have installed a new brake cable, or if the cable has excessive slack, cut the cable roughly 1 inch past the pinch bolt and add an end cap to prevent fraying.

CONSIDERATIONS

The brake is now properly adjusted and ready to test ride. Here are some other considerations that may come into play during this process:

BRAKE PAD WEAR

As the pads wear, you will need to make further adjustments to keep the lever feel consistent. Tighten the pad adjusters to bring the pads closer to the rotor. Move the adjusters evenly in small increments and test at the lever.

Calipers with a single pad adjuster will need to reset the caliper position from scratch as the pads wear — refer to **STEP 1**.

IMPORTANT

Do not use the barrel adjuster to move the pads inward as they wear. This will eventually move the lever arm to a position where it is contacting another part of the caliper, preventing the pads from contacting the rotor. The barrel adjusters should only be used to take out cable slack as the cable and housing system settle in.

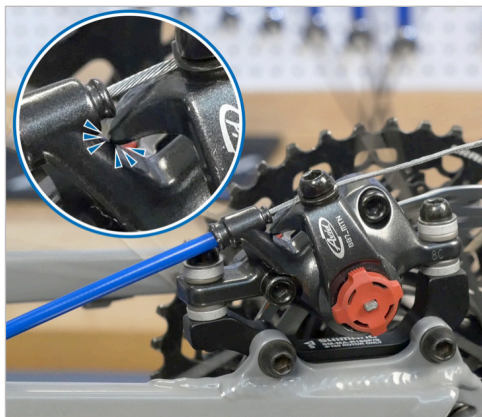

ON THIS CALIPER, THE BARREL ADJUSTER WAS USED TO COMPENSATE FOR WORN BRAKE PADS. AS A RESULT, WHEN THE BRAKE IS ENGAGED THE LEVER ARM CONTACTS THE CALIPER BODY BEFORE THE PADS MEET THE ROTOR, RESULTING IN *NO BRAKES

CABLE & HOUSING WEAR

Worn, dirty or corroded cable and housing can drastically affect the performance of the braking system. Replace these components if necessary — see Brake Housing & Cable Installation for Upright Bars or Drop Bars.

MOUNT FACING

In some cases, frame mounts may not be perfectly square to the rotor, causing lateral misalignment at the caliper. There is often no adjustment possible for this type of misalignment, but a professional shop may be able to face or machine the mounts with the Park Tool DT-5.2 to improve alignment.

CONICAL WASHERS

Some manufacturers use a system of mating conical washers. These help to align the vertical face of the pads to the rotors. These washers must be designed into the system, and cannot be added to brakes not designed for them. Additionally, if the brakes came with these washers they must be used. If there are conical washers only on top of the caliper, they should remain on top.

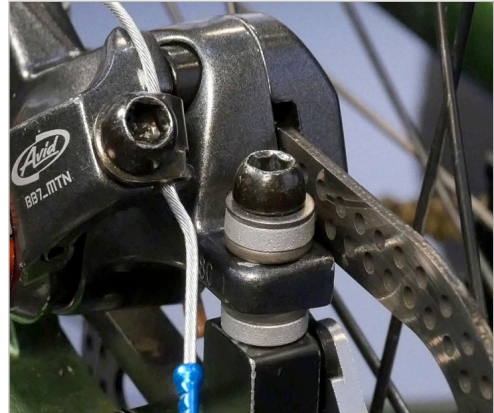

CALIPER WITH AVID CPS CONICAL WASHER SYSTEM

7 SPEED DERAILLEUR TUNING

DIAGRAM



BARREL CABLE
ADJUSTER

H LIMIT SCREW

L LIMIT SCREW

CABLE
ADJUSTMENT
BOLT

TOOLS REQUIRED



PHILLIPS
SCREWDRIVER



9MM
MULTI-TOOL

WE STRIVE FOR PERFECT. ALTHOUGH IT 'S NOT ALWAYS POSSIBLE, WE NEVER LEAVE A RIDER BEHIND.

01

To adjust the rear derailleur, first twist the shifter until the number **7** is highlighted on the shift knob.



02

Rotate pedals until the chain falls into the smallest cog.



03

Turn the barrel adjuster located on the rear derailleur clockwise until it stops.



BARREL
ADJUSTER

04

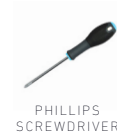

If the chain still hasn't reached the smallest cog, then you will need to adjust the "High Gear" limiting screw located on the derailleur (indicated by the letter **H**).

With a Phillips screwdriver, gradually turn the screw counterclockwise 1/4 turn at a time while rotating the pedal until the chain falls onto the smallest cog.



NOTE

The "High Gear" limiting screws are very sensitive. We recommend using only 1/4 turn at a time, in case you have to revert back to it's original position.

05



Now adjust the cable tension, which controls how your bike will shift. Using a 9mm crescent wrench or the multi-tool, loosen the cable adjustment screw and pull on the cable. While keeping tension on the cable, tighten the cable adjustment screw.



06

Rotate the pedals and try to shift between gears. If it doesn't shift from 7th to 6th gear in one click, then the cable needs to be tightened. To tighten the cable, twist the barrel adjuster counterclockwise 1/4 turn at a time until it is able to shift from 7th to 6th gear in one click.

Shift through the gears from 7th to 1st, then back from 1st to 7th. If the gears feel sluggish when shifting from 7th to 1st, tighten the cable by turning the barrel adjuster counterclockwise. If shifting feels fine from 7th to 1st, but sluggish from 1st to 7th, loosen the cable by turning the barrel adjuster clockwise.

Continue to adjust the derailleur cable until you are able to shift between each gear with a single click.



NOTE

Each gear should shift with a corresponding "click" sound.

21 SPEED DERAILLEUR TUNING

DIAGRAM

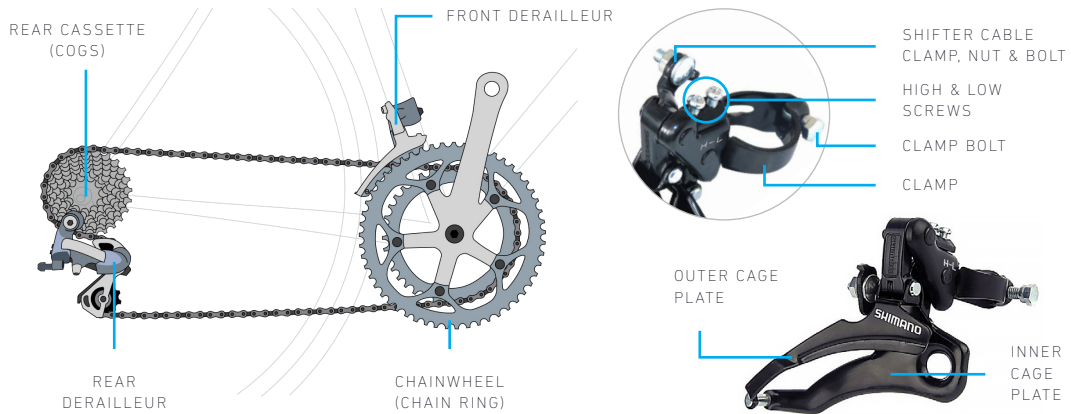

WE STRIVE FOR PERFECT. ALTHOUGH IT 'S NOT ALWAYS POSSIBLE, WE NEVER LEAVE A RIDER BEHIND.

NOTE

We tune every bike before packaging, but I would still recommend checking the tuning. It's possible that they may need to be readjusted after being shipped to you. These instructions are designed to help if your bike needs a little extra work.

If you don't feel comfortable working on your bike, we suggest taking it to your local bike shop for final assembly.

TOOLS REQUIRED



PHILLIPS
SCREWDRIVER



9MM
MULTI-TOOL



5MM
ALLEN KEY



MALLET OR
HAMMER

FRICTION SHIFTER

The front shifter is a "Friction" shifter. This just means that there is no specific level set for each gear. You will be shifting generally by "feel", so when you twist this shifter, make sure to pay attention to see if your gear is shifting up or down.

We do this for two reasons:

For the majority of commuter and recreational type riding, the rider won't want to be shifting the front shifter a lot.

It allows smoother shifting and allows more of a selection than an Index shifter.



CAUTION

Please be careful with the derailleur cage as it has tension that causes the cage to pull back into the frame when attached to the shifting cable.

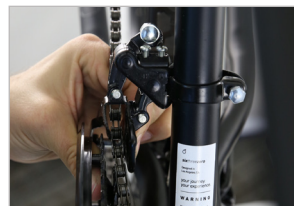

2 PERSON ASSEMBLY RECOMMENDED

We recommend to have an extra person assist you in the tuning of the front derailleur.

Person 1, will be responsible for lifting the bicycle off the ground while Person 2, will be in charge of pedaling and shifting.

Doing this, will facilitate your overall assembly experience.

DERAILLEUR POSITION

01

Check your bike's tuning by taking it for a test ride. Shift the front derailleur up and down to check each gear while riding. If you hear any rubbing coming from the chain hitting the derailleur in any of the gears, you will need to tune the front derailleur.



02

Shift the front derailleur to the smallest gear.



03



9MM
MULTI-TOOL

Use a 9mm wrench/socket to loosen the nut that clamps the shifting cable to the front derailleur. This will disconnect the shifting cable from the front derailleur.

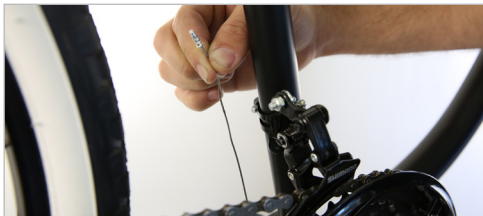
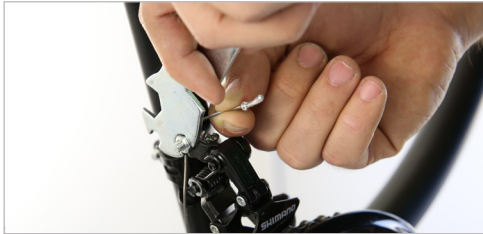

04



2 PENNIES

Lift the chain and pull the cage away from the bike to place a penny in between the outer cage and the largest chainwheel. If you can fit two pennies, then your front derailleur is too high. If the penny fits snugly in between the outer cage and the chainwheel, you can move to step 6.



05

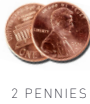

Untighten the clamp with a 9mm wrench/socket a quarter turn at a time until you are able to tap the derailleur slightly up and down without it falling completely down the seat tube. While still pulling the cage forward, grab a penny and place it above the largest chainwheel. Adjust the height of the derailleur cage so it sits above the penny. With a mallet/hammer and the allen key, you can slightly tap the derailleur up or down based on its original position. Reference the bottom right image as an example. Now tighten the cage in place with a 9mm wrench/socket.

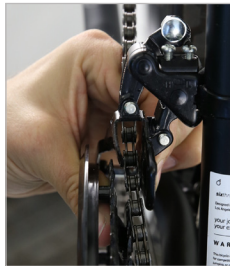
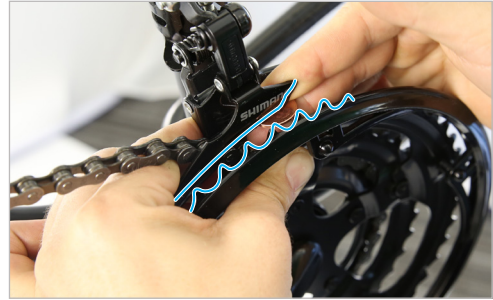

WE STRIVE FOR PERFECT. ALTHOUGH IT 'S NOT ALWAYS POSSIBLE, WE NEVER LEAVE A RIDER BEHIND.

06

Once the height is set, we must check the angle of the cage. Lift the chain and pull the cage forward and view the cage from above. The inside of the outer cage plate must be parallel to the largest chainwheel. If your outer cage plate is parallel to the largest chainwheel, you can move to step 8.

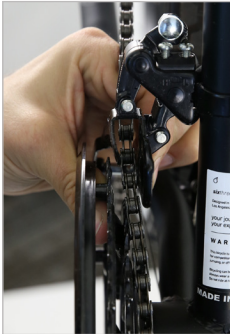

07



9MM
MULTI-TOOL

If your outer cage plate is NOT parallel to the largest chainwheel, untighten the clamp a quarter turn at a time until you are able to slightly move the derailleur.

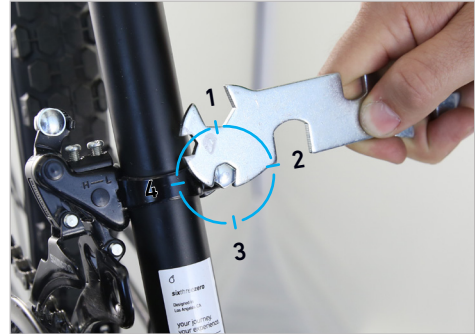

08



9MM
MULTI-TOOL



MALLET
OR HAMMER

Based on the angle, tap on the back or the front of the cage after every turn until it moves slightly.

Tap the cage left or right to align the cage plate and the largest chainwheel. Recheck the angle to make sure that they are parallel. Now tighten the cage in place with a 9mm wrench/socket.

NOTE

If you untighten the derailleur too much, it will potentially offset the height of the derailleur causing a need to repeat step 5.



09



9MM
MULTI-TOOL

Pull the shifting cable up, align it behind the clamping nut, and make sure to pull out any slack in the cable. Tighten the shifting cable to the derailleur by using a 9mm wrench/socket.



NOTE

Derailleurs work off of tension, and this is the reason that they are designed with High and Low Limiter screws. The High and Low Limiters essentially act as boundaries so that no matter how much tension you put into or take off the shifter cable, the derailleur will not go past the largest or smallest gears. The High (H) screw is the limiter for the largest gear, and the Low (L) screw is the limiter for the smallest gear.

COUNTERCLOCKWISE

Turning the **L & H** counterclockwise shortens the range where the derailleur cage can travel.

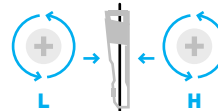

CLOCKWISE

Turning the **L & H** clockwise increases the range where the derailleur cage can travel.

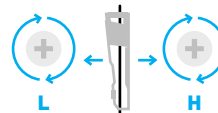

LIMITER SCREWS

10

Now, let's check the H limit screw. Begin by shifting the derailleur to 3rd gear. While turning the pedals, shift into 3rd gear. If the chain does not fall off the largest chain-wheel when shifting into 3rd gear, the H limit screw is close to proper positioning.



11

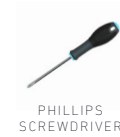

PHILLIPS
SCREWDRIVER

Reference the bottom left image below to check if the derailleur is properly adjusted. If it matches the images, please move forward to Step 12. Looking through the front of the derailleur cage, decide whether the chain is too close to the inner or outer cage plates. If the chain is too close to the outer cage plate, turn the H screw clockwise a quarter turn at a time until it is centered. If the chain is too close to the inner cage plate (closer than the outer cage plate or it is rubbing), then turn the H screw counter-clockwise a quarter turn at a time until it is centered.

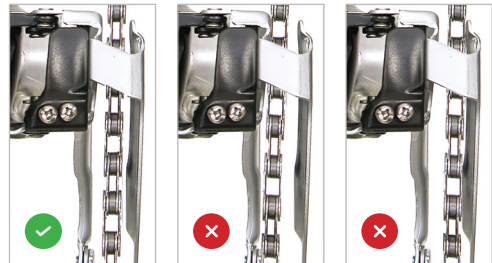

12

Now, let's check the L limit screw. Begin by shifting the derailleur to 1st gear. While turning the pedals, shift into 1st gear. It may take more than 1 click. If the chain does not fall off the smallest chainwheel after shifting from 2nd to 1st, the L limit screw is close to proper positioning.



13



Reference the image below on the left, if the chain is centered in between the inner and outer cage plates, you can move on to step 14, Micro Adjustments. If the chain is NOT centered in between the inner cage, you will need to use a Phillips head to center the inner walls of the cage to the chain. Looking overhead at the cage and inspect its current position.

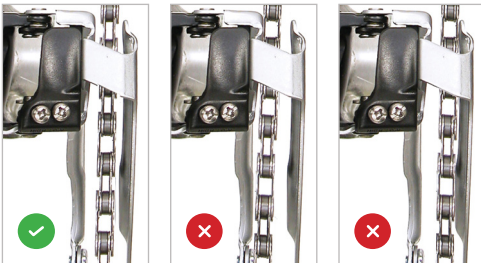

14

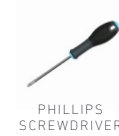

Based on the screws original position, take note of the amount of quarter turn rotations given in either direction to the L screw, until the inner and outer cage plates are centered. If the outer cage plate is too far in and rubbing against the chain, you have to turn the L screw counter-clockwise. If the inner cage plate is too far out and rubbing against the chain, you have to turn the L screw clockwise.



CABLE TENSION AND SHIFTING

15

Now that you have adjusted the limiter screws, let's check each gear to make sure that the derailleur is shifting correctly. Shift from 1st gear to 2nd, 2nd to 3rd gear, and from 3rd to 1st gear. If you can pedal the bike in each gear without hearing rub, and it's shifting up and down without resistance or lag, the front derailleur is properly adjusted. If not, we will need to do some minor adjustments with the barrel adjuster.



16

Locate the barrel adjuster located on the front shifter where the cable comes out of the shifter. Note/Explanation: The barrel adjuster will change the amount of tension on the shifting cable. This helps the derailleur move up and down the gears. Turn the barrel adjuster counter-clockwise a quarter turn at a time while pedaling the bike. Keep checking for rub/lag on each gear until it disappears. If the rub/lag persists, please feel free to contact one of our mechanics to help you troubleshoot this last step.



BATTERY INSTALLATION



WE STRIVE FOR PERFECT. ALTHOUGH IT 'S NOT ALWAYS POSSIBLE, WE NEVER LEAVE A RIDER BEHIND.

01

To be able to use the electric motor, the battery must be mounted by sliding the fully charged battery forward into the battery holder. Follow the guides on the rear rack and battery for proper installation.



02

The battery automatically locks into the bike when fully inserted in the battery holder. The locking mechanism unlocks when the key is turned to the open position, allowing the battery to slide out.

UNLOCKED



LOCKED



The battery must be locked when riding or it may fall out. The key does not have to be in to operate the bike. Store the keys in a safe place.

03

The red on/off switch is located on the bottom of battery. After fully inserting the battery into place, turn the battery on by flipping the switch to the "I" position. Be sure to turn off the power when the bicycle is not in use or is recharging by clicking the battery switch to the off "O" position.



ON



OFF



BATTERY CHARGER

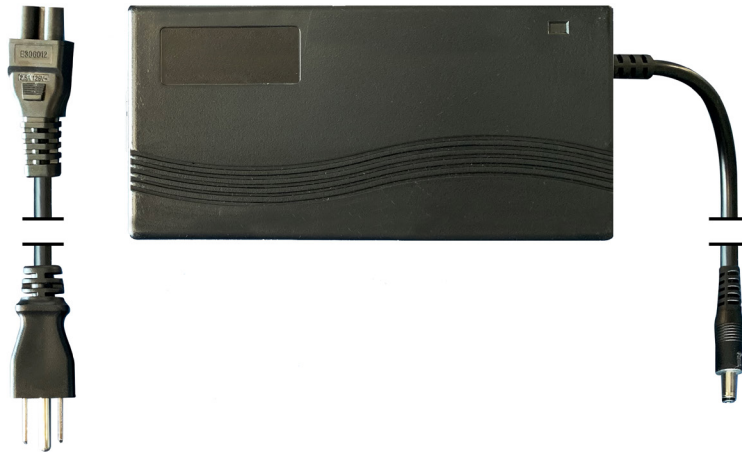

WE STRIVE FOR PERFECT. ALTHOUGH IT 'S NOT ALWAYS POSSIBLE, WE NEVER LEAVE A RIDER BEHIND.

01

Included with your new sixthreezero is a lithium ion battery, along with a charger, which plugs into a standard household electric outlet.

A lithium ion battery requires specially designed chargers. You should never charge your battery with a substitute charger that is not designed for this use. Use of an unsuitable charger to charge a lithium ion battery could result in over-heating, fire or even explosion.

Our batteries contain a charger manual from our supplier. Reference the booklet for additional information.



250W - 36V (42V-2A)

500W - 48V (54.6V 2.0A)



RECHARGING THE BATTERY

02

The battery may be charged while on the bike or removed and charged at a location away from the bicycle. The battery is easily removed by turning the key lock to the open/unlock position, grasping the underside of the battery, and sliding the battery out of the downtube by using the bottom side as a hinge.

To charge the battery, plug the charger into an AC outlet. The LED indication light should be green showing the charger is working normally. Then plug the charger into the charging port located on the bottom or side of the battery by sliding open the charger cover.

The charger will charge a fully depleted battery in 4—5 hours. The indicator light on the charger will be red/orange when battery is charging and will turn green when fully charged.

If the battery will not be used for an extended period of time, charge it fully and recharge it every 2 months. Store it in a cool, dry place. Your battery is engineered with precision for high capacity and a long, useful life. Do not use it to power other electrical devices. Improper use of the battery will damage the battery and shorten its useful life and may cause fire or an explosion. If you experience unusual sounds or odors coming from the charger or the battery, unplug charger immediately and contact sixthreezero customer service.

CAUTION

Avoid subjecting the battery to high temperatures, such as directly under the sun, for prolonged periods of time. Recharge the battery before it becomes completely discharged. Completely discharging will reduce the numbers of recharging cycles during the battery's life and limit the capacity. Never store the battery in a discharged state. After much use, your battery's charge-holding capacity will decrease. If you find that your battery does not hold a sufficient charge, you should contact your local dealer to order a replacement.

NOTE

- Recharge battery after every use.
- Do not disassemble or alter the battery or battery charger.
- Do not place the battery near fire or corrosive substances.
- Do not allow any liquids on or inside the battery/charger.
- Do not expose the battery/charger to extreme weather conditions.
- Do not operate the battery/charger if damaged.
- Recharge the battery only with a charger specified by the manufacturer.
- Do not use the battery/charger for any use other than its intended purpose.
- Only use the battery/charger on sixthreezero approved products.

DISPLAY + PEDAL ASSIST MODE



WE STRIVE FOR PERFECT. ALTHOUGH IT 'S NOT ALWAYS POSSIBLE, WE NEVER LEAVE A RIDER BEHIND.

01

Your sixthreezero is equipped with an LCD display that monitors pedal assist, speed, odometer, trip distance, riding time, and battery energy level. To turn the meter on, make sure the battery is fully inserted into the sixthreezero and the on/off switch is in the on "I" position.

Press the button labeled M (center button) on the three button selector located near the left grip on the handlebars to turn the display on. You can adjust the pedal assist power level to have more power by hitting the [+] button (third button) and can move to a lower level power by hitting the [-] button (fourth button).

When not riding the bike, you can turn off the display by holding down the power button (top button) for several seconds.

THROTTLE OVERDRIVE

Full power on demand.
Overrides pedal assistance

FREE RIDE

Pedal just like a normal bicycle
with all the display features active.

CADENCE MODE

Reaches designated speeds
while pedaling.

HAND THROTTLE CONTROL



WE STRIVE FOR PERFECT. ALTHOUGH IT 'S NOT ALWAYS POSSIBLE, WE NEVER LEAVE A RIDER BEHIND.

01

When the pedal assist mode is set to "0", the pedal assist and throttle function(s) do not engage. When the pedal assist mode is set to "6" the pedal assist function does not engage and the throttle will accelerate the bike forward.

The throttle control is operated on the right hand side. You control the throttle by twisting it from its resting position. The farther the throttle switch is delivered to the motor to accelerate the bicycle. When you want to slow down, you simply release the throttle and let it return to its resting position and simultaneously apply the brakes.

The sixthreezero also comes with a Throttle Override function which allows the throttle to work in pedal assist modes.



TROUBLESHOOTING

01

If your sixthreezero is not working, check the Quick Disconnect fittings to make sure they did not come loose or unplugged.

There are 4 total colored Quick Disconnect fittings to check:

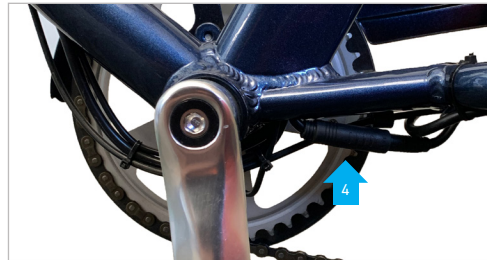
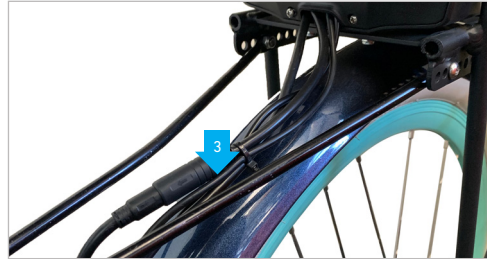
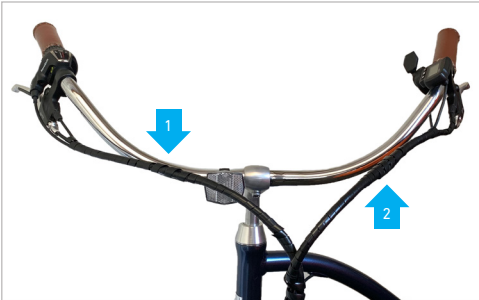

02

Simply unwrap the black spiral wire covering until the Quick Disconnect fitting is exposed. If necessary, un-thread and re-thread the Quick Disconnect fitting(s).

Make sure that the battery is inserted fully into the bicycle. If it is not, the bicycle will receive no power causing all of the electronics to not turn on.

For any additional troubleshooting help, please feel free to contact our team at:

(310) 982-2877

theteam@sixthreezero.com

SURVEY

Tell us about your assembly experience. If you have/had any trouble at all or didn't, and would like to leave feedback and help us improve our assembly instructions you can.

Type this URL into your browser:

goo.gl/6enZji

FAQ

Q. How long does it take to fully charge the battery?

A. Depends on the state of discharge but around 4-5 hours if completely discharged.

Q. What are the running costs for an electric bike?

A. You will have no worries about rising fuel prices at the pumps. All our electrically powered vehicles use household electricity. The average cost per full charge is about 10 cents per charge. If you charge the battery every single day for a year, it would cost you about \$35 per year.

Q. Do I have to wait for the battery to empty before I charge it?

A. No. The batteries we use are Lithium-ion batteries which do not suffer from 'memory effect'. This means that there is no need to discharge a battery completely before you recharge it again. You can partially recharge the battery at any time without reducing its voltage or lifespan. We recommend recharging the battery after every use, regardless of how far you rode.

Q. Do I need a driver's license, insurance or registration?

A. No, you don't. According to Federal law, electric bikes that are under 750 watts are classified as bicycles. For all intents and purposes, it's simply a bicycle that requires very little pedaling to travel 20 MPH (32 Km/H), saving you time and hassle. Check your local state laws for requirements.

Q. Do I need to pedal an electric bike?

A. No, but it helps to prolong battery life. The motor on our bikes is both throttle and pedal assist controlled, allowing you to decide how much power you desire. Have you ever tried to cycle when speeding downhill on your normal bicycle? It's just like that. The motor is propelling you faster than you're cycling so there is pretty much no resistance, it's merely a formality!

Q. What happens if I get a flat tire?

A. The tires on our bikes are the same as conventional bicycles. Simply replace the tube with a tube of the right size and inflate it. No special tires or parts will be needed.

Q. What happens when I use the brakes under powered assistance?

A. All our bikes are equipped with brake levers that have a built-in safety switch that automatically cuts off the motor power under normal braking conditions. This not only ensures a safe un-powered stopping feature, but also protects the motor under braking conditions so that it isn't working against the brakes.

Q. How far will a Sixthreezero take me?

A. Cycling with pedal assist along a straight road under normal conditions, the standard battery should last 15-30 miles (24 - 48 kilometers). Cycling up steep hills will take more energy out of the battery and factors such as road surface, wind resistance, weight of the rider and tire pressure will affect your range.

Q. Can I put a Sixthreezero on a bike rack?

A. Each bike rear rack has a specific weight limit. Our eBikes weigh a total of 70lbs. Make sure that the bike rack can hold the weight of a Sixthreezero. We advise taking the battery off to make it easier to lift and to keep safe.

Q. Can I ride up hills and against strong headwinds on my sixthreezero electric bike?

A. Yes. One of the main advantages of cycling on a Sixthreezero electric bicycle is that it literally flattens hills and increases your average speed when tackling inclines and headwinds. You will be amazed at the relative ease that your new Sixthreezero electric bike can tackle some of the most arduous journeys.

Q. How do I know when the battery is low?

A. The bicycles have easily visible indicators located on the meters that show the amount of juice left. If it is getting low and you don't think you will make it to your destination, you can switch off your motor and keep it just for the difficult bits.

Q. Can I put a child's trailer on a Sixthreezero?

A. Yes, you can certainly add a trailer to your Sixthreezero. Contact us for child trailer recommendations.

WARRANTY

What is covered and for how long?

For two (2) years after the date of purchase by the original retail purchaser, Sixthreezero warrants to the original retail purchaser that Sixthreezero's Electric Bike ("Bike") and Bike battery ("Battery") (individually, "Product" and collectively, "Products") will be free from defects in material and workmanship under normal use and service. However, this Limited Warranty's coverage for the Battery is limited to defects in material and workmanship in a Battery that has been charged no more than 500 times, and which result in the Battery's leakage or failure to hold a charge.

What is not covered?

This Limited Warranty does not cover: (a) defects or damage resulting from accident, abuse, misuse, abnormal use (including but not limited to stunt riding, racing or other similar activities not consistent with the intended use of the Products), improper storage, abnormal exposure to liquid, chemicals, moisture, abrasives, sand or dirt, neglect, or abnormal physical,

electrical or electromechanical stress; (b) scratches, dents and cosmetic damage, unless caused by Sixthreezero; (c) Product that has the serial number or the barcode removed, defaced, damaged, altered or made illegible; (d) ordinary wear and tear; (e) defects or damage to the Products caused by the use of accessories, products, or ancillary/ peripheral equipment not furnished or approved by Sixthreezero with the Products; (f) defects or damage caused by assembly, testing, operation, maintenance, installation, service, repair, or adjustment in a manner that varies from Assembly Instructions & Owners Manual; (g) defects or damage resulting from external causes such as collision, fire, flooding, windstorm, lightning, earthquake, exposure to weather conditions, theft, blown fuse or improper use of any electrical source; or (h) Products used or purchased outside the U.S.

The Limited Warranty does not cover defects or damage: (i) caused by charging by a battery charger not intended or appropriate for use with the Battery or the improper use of a battery charger; (ii) where any of the seals on the Battery are broken or show evidence of tampering; (iii) where the Battery has been used in equipment other than the Bike for which it is specified; or (iv) in a Battery that has been charged more than 500 times.

What are Sixthreezero's obligations?

During the two-year Limited Warranty period, provided the Product is returned in accordance with the terms of this Limited Warranty, Sixthreezero will have a qualified technician evaluate the returned Product, and:

BATTERIES:

If the technician determines the claimed defect in the Battery is covered under the terms of the Limited Warranty, Sixthreezero will replace the Battery without charge for the replacement battery. All such costs will be the sole responsibility of the consumer. The replacement battery will be covered by the Limited Warranty for a period equal to the remainder of the original Limited Warranty on the original Battery or for ninety (90) days from the date of the replacement, whichever is longer. Any replaced Battery and removed Battery components will become the property of Sixthreezero. Except to any extent expressly required by applicable law, transfer or assignment of this Limited Warranty is prohibited.

BICYCLE:

If the technician determines the claimed defect in the Bike is covered under the terms of the Limited Warranty, Sixthreezero will repair or replace the Bike, at Sixthreezero's sole option, without charge, and will reimburse the original retail purchaser for shipping, at standard ground shipping rates, and any insurance costs incurred as a result of returning the Bike to Sixthreezero for warranty work. Sixthreezero may, in Sixthreezero's sole discretion, use new, rebuilt or reconditioned parts or components when repairing the Bike, or may replace the Bike with a new, rebuilt or reconditioned Sixthreezero Electric Bike of the same or equivalent model. The repaired/replaced Bike will be covered by the Limited Warranty for a period equal to the remainder of the original Limited Warranty on the original Bike or for ninety (90) days, whichever is longer. Any replaced Bike and Bike components will become the property of Sixthreezero. Except to any extent expressly required by applicable law, transfer or assignment of this Limited Warranty is prohibited.

How do I obtain limited warranty service?

BATTERIES:

To obtain service under this Limited Warranty, you must submit to Sixthreezero a Limited Warranty claim that includes the following material and information: (i) the original sales receipt or proof of purchase of the Product showing the original date of purchase, the serial number of the Product and the seller's name and address; (ii) a Warranty Product Return Authorization Number ("WPRAN"); and (iii) pictures of the Battery, including a picture of each side of the battery, one of which must show the Battery's serial number. To obtain a WPRAN and/or obtain assistance on where to deliver the documentation please contact Sixthreezero Customer Care at (310) 982-2877 or by emailing theteam@sixthreezero.com.

BICYCLE:

To obtain service under this Limited Warranty, you must remove the Battery from the Bike and return the Bike to an authorized Sixthreezero facility, in an adequate container for shipping, accompanied by: (i) the original sales receipt or other proof of Purchase showing the original date of purchase, the serial number of the Bike and the seller's name and address; (ii) a WPRAN; and (iii) a prepaid return shipping label which provides for the return of the Bike to the original retail purchaser and insurance during the transport. To obtain assistance on where to deliver the Bike and obtain a WPRAN, please at (310) 982-2877 or by emailing theteam@sixthreezero.com. If Sixthreezero determines that any Product is not covered by this Limited Warranty, you will be responsible for paying for all parts, shipping, insurance and labor charges for the repair and/or return of such Product.

What are the limits on Sixthreezero's liability?

THIS LIMITED WARRANTY SETS OUT THE FULL EXTENT OF SIXTHREEZERO'S RESPONSIBILITIES AND THE EXCLUSIVE REMEDY REGARDING THE PRODUCTS. ALL IMPLIED WARRANTIES, INCLUDING WITHOUT LIMITATION, IMPLIED WARRANTIES OF MERCHANTABILITY AND FITNESS FOR A PARTICULAR PURPOSE, ARE LIMITED TO THE DURATION OF THIS LIMITED WARRANTY. IN NO EVENT WILL SIXTHREEZERO BE LIABLE FOR DAMAGES IN EXCESS OF THE PURCHASE PRICE OF THE PRODUCT OR FOR, WITHOUT LIMITATION, COMMERCIAL LOSS OF ANY SORT; LOSS OF USE, TIME, DATA, REPUTATION, OPPORTUNITY, GOODWILL, PROFITS OR SAVINGS; INCONVENIENCE; INCIDENTAL, SPECIAL, CONSEQUENTIAL OR PUNITIVE DAMAGES; OR DAMAGES ARISING FROM THE USE OR INABILITY TO USE THE PRODUCT, EVEN IF SIXTHREEZERO HAD REASON TO BELIEVE SUCH DAMAGES WERE POSSIBLE. SOME STATES AND JURISDICTIONS DO NOT ALLOW LIMITATIONS ON HOW LONG AN IMPLIED WARRANTY LASTS, OR THE DISCLAIMER OR LIMITATION OF INCIDENTAL OR CONSEQUENTIAL DAMAGES, SO THE ABOVE LIMITATIONS AND DISCLAIMERS MAY NOT APPLY TO YOU.

SIXTHREEZERO MAKES NO WARRANTIES OR REPRESENTATIONS, EXPRESS OR IMPLIED, STATUTORY OR OTHERWISE, AS TO THE QUALITY, CAPABILITIES, OPERATIONS, PERFORMANCE OR SUITABILITY OF ANY THIRD-PARTY EQUIPMENT OR SOFTWARE USED IN CONJUNCTION WITH THE PRODUCT, OR THE ABILITY TO INTEGRATE ANY SUCH EQUIPMENT WITH THE PRODUCT. RESPONSIBILITY FOR THE QUALITY, CAPABILITIES, OPERATIONS, PERFORMANCE AND SUITABILITY OF ANY SUCH THIRD-PARTY EQUIPMENT AND SOFTWARE RESTS SOLELY WITH THE USER AND THE DIRECT VENDOR, OWNER OR SUPPLIER OF SUCH THIRD-PARTY EQUIPMENT AND SOFTWARE.

Nothing in the Assembly Instructions & Owners Manual or Product information, instructions or advertisements is intended to create or be construed as an express warranty of any kind with respect to any Product. No agent, employee, dealer, representative or reseller is authorized to modify or extend this Limited Warranty or to make binding representations or claims, whether in advertising, presentations or otherwise, on behalf of SIXTHREEZERO regarding the Products or this Limited Warranty. This Limited Warranty gives you specific legal rights, and you may also have other rights that vary from state to state.

What is the procedure for resolving disputes?

ALL DISPUTES WITH SIXTHREEZERO ARISING IN ANY WAY FROM THIS LIMITED WARRANTY OR THE SALE, VALUE, CONDITION OR PERFORMANCE OF THE PRODUCTS MUST BE RESOLVED EXCLUSIVELY THROUGH FINAL AND BINDING ARBITRATION, AND NOT BY A COURT OR JURY, WITH THE SOLE EXCEPTION THAT NOTHING IN THIS PROVISION WILL PROHIBIT ANY SUCH DISPUTE FROM BEING RESOLVED AS AN INDIVIDUAL CLAIM IN A SMALL CLAIMS COURT. Any such dispute, whether arbitrated or brought in small claims court, will not be combined or consolidated with a dispute involving any other person's or entity's product or claim, and specifically, without limitation of the foregoing, must not under any circumstances proceed as part of a class action or collective action. It is the express intent of the parties that any and all disputes will be resolved on an individual basis only, and that the arbitrator will not have the power to award class or collective relief or to determine or order that the dispute should proceed as a class or collective

action, whether in arbitration or in any other forum or venue. The arbitration will be conducted before a single arbitrator, whose award must not exceed, in form or amount, the relief allowed by the applicable law. The arbitration will be conducted according to the American Arbitration Association ("AAA") rules and procedures applicable to consumer disputes (which currently may be found at www.adr.org) or, if AAA consumer dispute rules and procedures cannot, for whatever reason, be applied, then according to JAMS consumer arbitration rules and procedures or other arbitration rules and procedures appropriate for use in consumer disputes. This arbitration provision is entered pursuant to the Federal Arbitration Act, and the substantive laws of the State of California, without reference to its choice of laws principles, will otherwise govern the interpretation of the Limited Warranty and all disputes that are subject to this arbitration provision. The arbitrator will decide all issues of interpretation and application of this arbitration provision and the Limited Warranty. Judgment may be entered on the arbitrator's final award in any court of competent jurisdiction.

This arbitration provision also applies to claims against SIXTHREEZERO'S employees, representatives and affiliates if any such claim arises from a Product's sale, value, condition or performance.

The original retail purchaser may opt out of this dispute resolution procedure by, no later than thirty (30) calendar days from the date of the original retail purchaser's purchase of the Product, (1) sending notice by e-mail to optout@SIXTHREEZERO.com, with the subject line: "Arbitration Opt Out." The opt-out email must include (a) the original retail purchaser's name and address; (b) the date on which the Product was purchased; (c) the Product model name or model number; and (d) the Product serial number (the Product serial number can be found (i) on the Product box; (ii) for Bikes, on the Bike stamped into the bottom of the frame below the bottom bracket; (iii) for Batteries, on a label on the Battery imprinted below a barcode on a metallic sticker; and/or (iv) for Batteries, engraved onto the metal Battery case); or (2) contacting

us and providing the same information. These are the only two forms of notice that will be effective to opt out of this dispute resolution procedure. Opting out of this dispute resolution procedure will not affect the coverage of the Limited Warranty in any way.

Severability.

If any portion of this Limited Warranty is held to be illegal or unenforceable, such partial illegality or unenforceability shall not affect the enforceability of the remainder of the Limited Warranty.

SIXTHREEZERO
Torrance, California

RECORD YOUR SIXTHREEZERO'S INFO

BICYCLE SERIAL # _____

DATE OF PURCHASE _____

BATTERY SERIAL # _____

DEALER'S NAME _____

MODEL _____

DEALER'S PHONE _____

COLOR _____

DEALER'S EMAIL _____

PLEASE REGISTER YOUR SIXTHREEZERO AT [SIXTHREEZERO.COM/REGISTER](https://sixthreezero.com/register)

You must register your sixthreezero within 30 days of purchase for warranty to be valid

BICYCLE SERIAL LOCATION

01

Most Sixthreezero bicycles have their serial number stamped into the headtube of the bicycle. Contact us if you're having trouble finding the serial number.



BATTERY SERIAL LOCATION

02

Each Sixthreezero battery has a serial number imprinted below a barcode on a metallic sticker. In addition to the sticker, any metal battery cases will have the serial number engraved in a secondary spot.



CONGRATULATIONS

You did it! Time to take your brand new bike for a spin.
Still have questions? We're happy to help.
Want to share your journey with us? We're happy about that, too.



SIXTHREEZERO

THETEAM@SIXTHREEZERO.COM

310.982.2877



SIX**THREE**ZERO
LOS ANGELES, CA

THETEAM@SIXTHREEZERO.COM
310.982.2877