

ASSEMBLY GUIDE

RIDE IN THE PARK - 3 & 7 SPEEDS

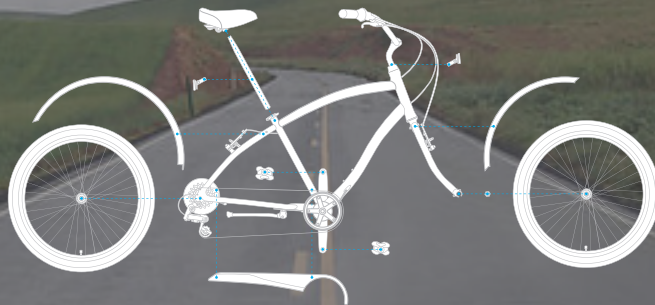

SIXTHREEZERO



OUR COMMITMENT

We want you to love your bike as much as we do.
If you run into any issues, no matter how small,
let us know and we'll take care of it.

SIXTHREEZERO

THETEAM@SIXTHREEZERO.COM

310.982.2877

MEET JACOB, OUR MECHANIC

Need assembly, repair, or installation assistance? He's your guy!
Want live help? Call or email to schedule an appointment.



MECHANICS@SIXTHREEZERO.COM

310.982.2877

A NOTE FROM
OUR MECHANIC

Welcome to the sixthreezero experience. Now for the fun part... the assembly.

I know, I know, we've all had to assemble something we've bought before - a tv stand, coffee table, possibly a grill or even a bike a time or two before. It's never fun, it never goes well, you always lose a nut or a screw and by the time you're done, you'd rather destroy whatever it is you've bought than actually use it. Well, I'm here to make sure that doesn't happen.

Assembly of a bike can be a fun, engaging, learning experience. Call up a friend, ask your spouse or child, don't

rush, and enjoy the process. Part of the fun in building your bike is telling people "I built it all by myself." I build bikes almost everyday and I always learn something new. I enjoy the process of building something from the ground up, and I hope you will too.

The instructions were written and designed by me, so if you have any suggestions please let me know!

Good luck,

A handwritten signature in black ink that reads "JACOB". The letters are stylized and connected, with a prominent flourish on the "J".

MECHANIC / SIXTHREEZERO

TOOLS YOU'LL NEED

Creating something wonderful with your own hands is basically the best feeling ever. We want you to have fun building your new bike, so there's only a few things you need to get started.



SCISSORS
(use to cut zip ties)



15MM CRESCENT WRENCH
or use the multi-tool provided



5 AND 6MM ALLEN KEY
(4MM NOT INCLUDED)



**PHILLIPS HEAD
SCREWDRIVER**



**SCHRADER VALVE
BICYCLE PUMP**



**2
PENNIES**



WHAT'S IN THE BOX?

Lay out all the parts in front of you.
Make sure you have all the parts before getting started.

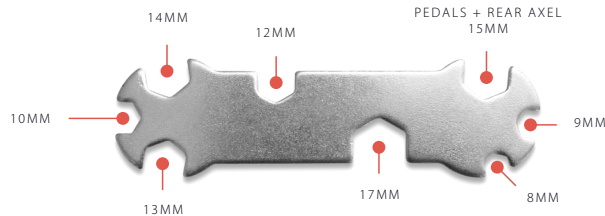



**HANDLEBAR / FRAME / REAR
WHEEL AND REAR RACK SET-UP**
seat post is zip-tied to frame



**QUICK RELEASE
FRONT WHEEL**



**FRONT AND REAR
REFLECTORS**



**ASSEMBLY
GUIDE**



**EXPERIENCE
BOOKLET**



MULTI-TOOL



**5 AND 6MM
ALLEN KEYS**





PEDALS



**QUICK RELEASE
SKEWER**



SEAT
attached to seat tube



BIKE PARTS REFERENCE GUIDE

All the names of all the parts for your bike, all in one place.
Keep this handy during assembly, and everything will go just fine.



FRONT WHEEL + REAR RACK

Parts required:



QUICK RELEASE
FRONT WHEEL



FRAME, REAR RACK
+ REAR WHEEL



QUICK
RELEASE SKEWER

Tools you'll need:



(4) 4MM ALLEN KEY SCREWS
PRE-INSTALLED ON SEAT STAYS



4MM ALLEN KEY
NOT INCLUDED



10MM ALLEN WRENCH
STEP 6

01

Spin the front fork so that the brakes are pointing forward. Turn the handlebars to match the Correct Image so that the cables don't loop around the headtube.

INCORRECT

The brakes are behind the fork.

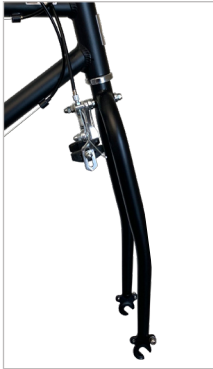

CORRECT

The front brake is facing away from the bike body.



02

Locate the quick release skewer in the small box. All of the components for the quick release skewer are attached.



Remove the adjustment nut (QR5) and spring #2 (QR4) from the rod (QR3).

NOTE

Quick release skewer must be installed correctly to avoid bicycle damage and/or injuries.

03



Fully insert the Rod (QR3) into the hollow axle of the wheel.

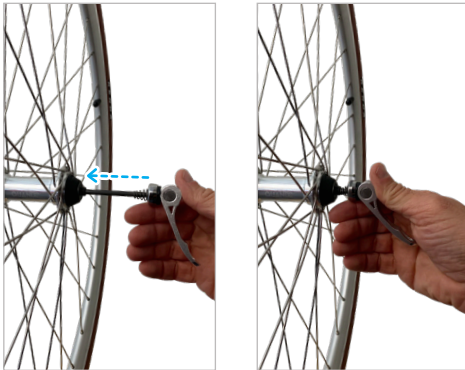

Slide quick release skewer completely through the hub.

STOP

After Step 3, no tools are required to install the front wheel. If the brakes are too tight that it won't allow the front wheel to insert completely into the fork, reference Step 6.



04



Place spring #2 (QR4) back onto the end of the rod (QR3), with the smaller end of the spring pointing inward. Loosely reinstall the nut (QR5) onto the rod (QR3).



05

Insert the wheel into the fork dropouts. If the brakes do not allow the wheel to pass, please see Step 06.

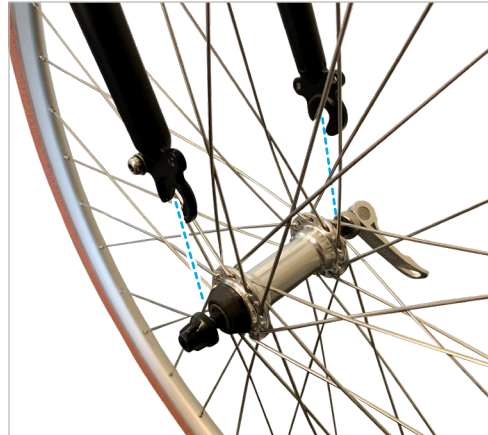

06



If the brakes are too tight to let the wheel pass, use a 10mm wrench to loosen and disengage the brake cable from the brake arm. We will reattach the brake cable in the Brake Assembly section.



07



Hold the lever (QR1) in the 'Open' position with one hand while tightening the nut with the other hand. Tighten until slightly snug but not tight.



08



Ensure that the wheel is centered in the forks. Hold the wheel in the centered position with your left hand. With your right hand, swing the lever (QR1) into the 'Closed' position. When closing the lever, the lever should swing slightly beyond 180-degrees. The closing motion should feel firm and leave a temporary impression in your palm.



NOTE

The lever at a 90° angle, should be tight enough to feel resistance when you close the lever. Make sure the front wheel is securely tightened and properly aligned so there are no issues when you assemble the brakes.

09

Once the front wheel is secured and centered, lower the kickstand and locate your rear rack.



10



4MM
ALLEN KEY
NOT INCLUDED



(2) 4MM ALLEN
KEY SCREWS
(Locted at rear rack mount)



REAR
RACK

Let's attach the rear rack. If the screws are pre-installed, unscrew them from the frame. Align the front arms of the rear rack to the eyelets on the frame below the seat. Use a 4mm allen key to tighten the screws and attach the rear rack arms to the frame. Repeat on both sides.



11



4MM
ALLEN KEY
NOT INCLUDED



(2) 4MM ALLEN
KEY SCREWS
(Locted at rear rack mount)



REAR
RACK

Install the bottom rear rack arms to the frame using the 4mm allen screws. Tighten with a 4mm allen key. Repeat on both sides.



HANDLEBAR, SEAT + PEDALS



HANDLEBAR



PEDALS



SEAT



6MM
ALLEN KEY



BICYCLE
PUMP



PHILLIPS
SCREWDRIVER



13MM + 15MM
MULTI-TOOL

12



HANDLEBAR



6MM ALLEN KEY

Insert stem into the lock nut.

Line up the stem, frame, and front wheel, then tighten the handlebar stem bolt using a 6mm Allen key.

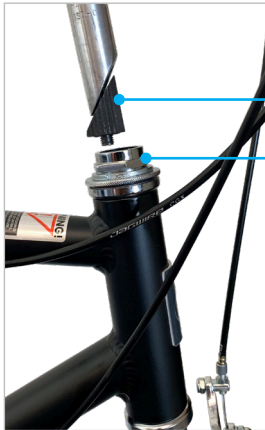

STEM

LOCK NUT

HANDLEBAR
STEM BOLT



NOTE

Straightening the stem, frame, and front wheel will ensure that your handlebars and wheel are properly aligned.

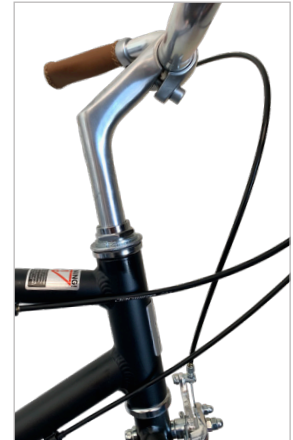

13



Loosen handlebar adjustment bolt using the 6mm Allen key to change the angle of the handlebars to your liking. Riders typically prefer their grips parallel to the ground.

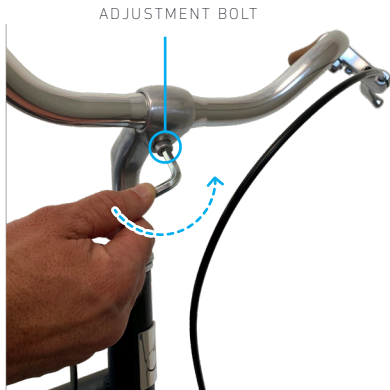

14

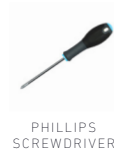

Locate your front reflector. Rotate the reflector so that it points forward.



Adjust the position of the front reflector and tighten the screw on the bracket with a Phillips Screwdriver.

15

Open seat post clamp. Holding the seat post firmly, insert into seat post tube until the top is level with your waist.

Close the seat post clamp lever.



CAUTION

Make sure not to drop seat post into the frame.

16



13MM
MULTI-TOOL

Tighten and close the seat post clamp lever. We will adjust the seat position in a later step.



17



PEDALS



15MM
MULTI-TOOL

Select the pedal stamped R and locate the right side of the bike (with the chain and chain guard). Align threading with the right crank arm, turning the pedal clockwise to tighten it.

Locate the pedal stamped L and align with the left crank arm. The left side pedal is reverse-threaded, tightening in a counterclockwise direction. Instead of lefty loosey, it is lefty tighty.

Hand tighten accordingly, then follow up by tightening both pedals with the 15mm multi-tool or crescent wrench.



RIGHT PEDAL



LEFT PEDAL

18



BICYCLE PUMP

Pump air into the tires to **40-65 PSI** as recommended on the sidewall of the tire.



19

Sit on the bike and check the angle formed by your knee. If your knee forms the incorrect angle, use the seat post clamp lever to raise the seat until you have a subtle bend or achieve a comfortable height.

CORRECT



INCORRECT



NOTE

The images above use a different bicycle, but the instructions are the same.

BRAKE ASSEMBLY + FENDER

DIAGRAM

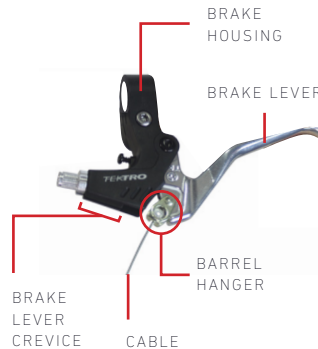
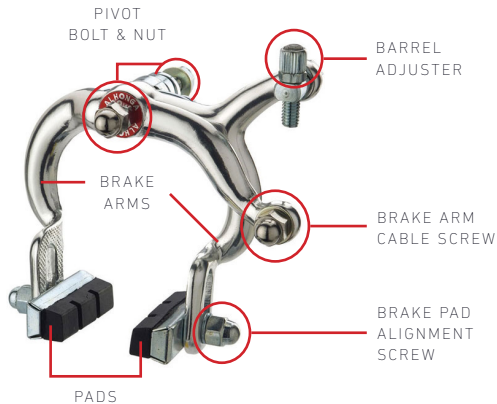

TOOLS REQUIRED



PHILLIPS
SCREWDRIVER



5MM
ALLEN KEY

NOTE

Sometimes the front brake cable is disconnected from the handlebar lever for shipping.

If your brake cable is not connected to the handlebar lever, please see steps 1-4.



ATTACHED
BRAKE CABLE

01

There are two ends to the brake cable.

One end has a barrel attached, while the other end has a cable cap attached to the end of the cable.

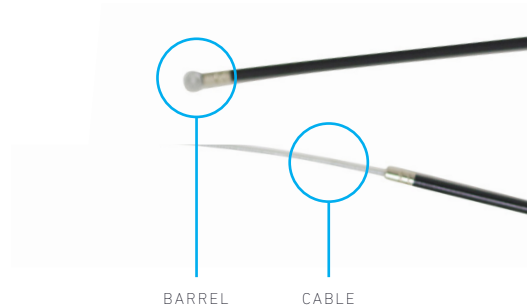

02

Attach the brake cable to the brake lever by squeezing the lever and inserting the round cable end into the linkage.



BARREL
HANGER

03

Slide the cable through the slotted opening in the brake lever. Insert the end cap of the cable housing into the brake lever.



BRAKE LEVER CREVICE

04

Slide the cable housing down toward the brake lever until it fits snug inside the barrel adjuster.

CABLE
HOUSING

BARREL
ADJUSTER

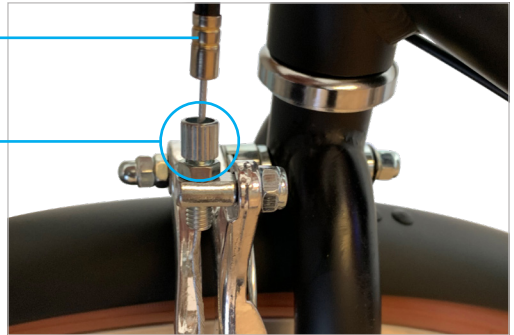

05



10MM
ALLEN WRENCH

Pinch the brake arms together till they are touching the rim. Simultaneously, pull the cable downward as tight as you can and retighten the cable bolt with a 10mm wrench or socket. When you release the brakes, they will likely pull more slack out of the cable and pull away from the rim. Spin the wheel to see if there is clearance between the rim and brake pads. You may need to tighten or loosen the brakes. Please see next step.

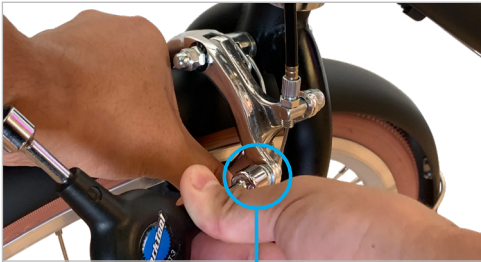

10MM BOLT

06



10MM
ALLEN WRENCH

If brakes are too loose, turn the barrel adjuster counterclockwise to increase cable tension. If brakes are too tight, you can loosen the cable at the bolt or make micro-adjustments by turning the barrel adjuster clockwise to relieve cable tension. Use the 10mm lock nut to lock your adjustment in place.

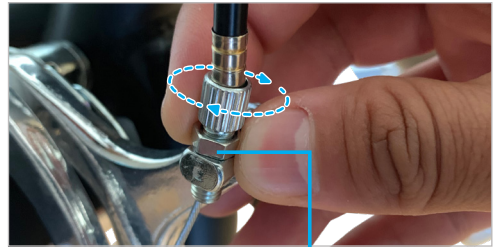

CABLE ADJUSTMENT
LOCK NUT

07



10MM
ALLEN WRENCH

Make sure the pads are evenly lined up with the rim. If the pads rub against the tire, they are too high; if they don't make full contact with the rim when braking, they are too low.

Adjust the positions by holding the brake pad with one hand and loosening the nut on the back with a 10mm Allen key.

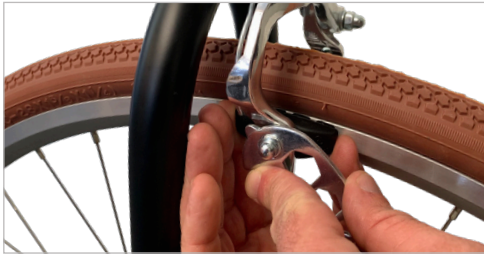

FENDERS

Locate the front fender. The strut will be attached to the fender.

Two 4mm Allen key screws will be attached to the fork eyelets.

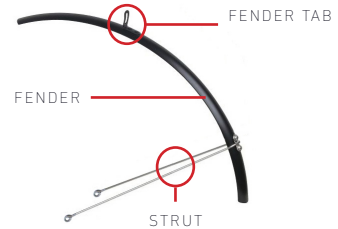

(2) 4MM ALLEN KEY SCREWS
PRE-INSTALLED ON FORK EYELETS



10MM
ALLEN WRENCH



4MM
ALLEN KEY

08



10MM
ALLEN WRENCH

Use a 10mm Allen wrench to remove the pivot nut behind the fork. We will be installing and centering the brakes at the same time.



09



10MM
ALLEN WRENCH

Once the pivot nut is removed, you will notice a curved washer. Leave that in place and insert the fender underneath the fork and slide the fender tab into the centering bolt as shown in the image below. Careful to not pull and detach the entire braking system.

FENDER TAB



CURVED WASHER

WE STRIVE FOR PERFECT. ALTHOUGH IT 'S NOT ALWAYS POSSIBLE, WE NEVER LEAVE A RIDER BEHIND.

10



10MM
ALLEN WRENCH

Before you tighten the brakes, pinch both brake arms against the rim. Use a 10mm Allen wrench to retighten the pivot bolt. By doing that, you have centered the brakes.



11



4MM
ALLEN KEY

Use a 4mm Allen key to attach the strut to the fork eyelets. Repeat on both sides.



3 SPEED TUNING

DIAGRAM



TOOLS REQUIRED



PHILLIPS
SCREWDRIVER



10MM
MULTI-TOOL

WE STRIVE FOR PERFECT. ALTHOUGH IT 'S NOT ALWAYS POSSIBLE, WE NEVER LEAVE A RIDER BEHIND.

01

Check and adjust gears. Shift into 2nd gear by twisting the shifting unit. The shifter has an outer exterior that resembles a golf ball, that us the part that turns.

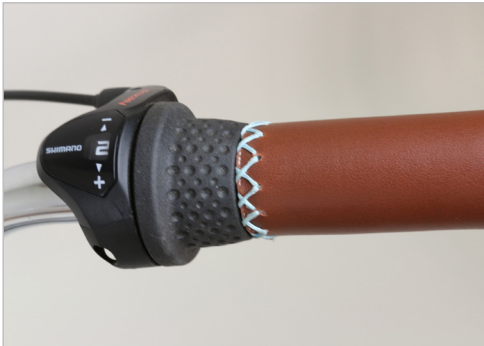

02

Look through the window in the back of the rear hub. If the yellow dot is within the parallel lines and arrows, your bike is properly adjusted. Please note that the yellow dot is only an approximate indicator. It is okay to move the dot outside of the lines if needed to obtain the best adjustment.



03



10MM
MULTI-TOOL

If not adjusted correctly, loosen the lock nut with a 10mm crescent wrench, and turn the adjustment barrel in either direction. The yellow dot will start to move.



04

Tightening the adjustment barrel in, moves the yellow dot away from the rear wheel. This decreases cable tension and helps to shift down into lower gears.



05

Untightening the adjustment barrel out moves the yellow dot in towards the rear wheel. This increases tension on the cable and helps to shift up into higher gears.



06



10MM
MULTI-TOOL

Center the yellow dot within the parallel lines. Once the yellow dot is within range, tighten down the nut using the 10mm crescent wrench.



7 SPEED TUNING

DIAGRAM



BARREL
ADJUSTER

H LIMIT SCREW

L LIMIT SCREW

CABLE
CLAMP
BOLT

TOOLS REQUIRED



PHILLIPS
SCREWDRIVER



9MM
MULTI-TOOL

WE STRIVE FOR PERFECT. ALTHOUGH IT 'S NOT ALWAYS POSSIBLE, WE NEVER LEAVE A RIDER BEHIND.

01

To adjust the rear derailleur, first twist the shifter until the number **7** is highlighted on the shift knob.



02

Rotate pedals until the chain falls into the smallest gear. Sometimes, the chain will not go all the way to the smallest gear at this point. This is okay. Please proceed to the next step.

SMALLEST COG



03

Turn the barrel adjuster located on the rear derailleur clockwise until it stops. At this point, detach the cable from the derailleur by loosening the Cable Clamp Bolt. We will leave the cable detached from the derailleur until we reattach it in Step 05.



BARREL
ADJUSTER

04

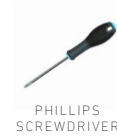

PHILLIPS
SCREWDRIVER

If the chain still hasn't reached the smallest cog, then you will need to adjust the "High Gear" limiting screw located on the derailleur (indicated by the letter **H**).

With a Phillips screwdriver, gradually turn the screw counterclockwise 1/4 turn at a time while rotating the pedal until the chain falls onto the smallest cog.



NOTE

The "High Gear" limiting screws are very sensitive. We recommend using only 1/4 turn at a time, in case you have to revert back to its original position.

05



Once the chain falls all the way into 7th gear, reattach the cable. Use a 9mm wrench to tighten the Cable Clamp Bolt to secure the cable to the derailleur.



06

Rotate the pedals and try to shift between gears. If it doesn't shift from 7th to 6th gear in one click, then the cable needs to be tensioned. To tension the cable, twist the barrel adjuster counterclockwise 1/4 turn at a time until it is able to shift from 7th to 6th gear in one click.

Shift through the gears from 7th to 1st, then back from 1st to 7th. If the gears feel sluggish when shifting from 7th to 1st, tighten the cable by turning the barrel adjuster counterclockwise. If shifting feels fine from 7th to 1st, but sluggish from 1st to 7th, loosen the cable by turning the barrel adjuster clockwise.

Continue to adjust the derailleur cable until you are able to shift between each gear with a single click.



NOTE

Each gear should shift with a corresponding "click" sound.

SURVEY

Tell us about your assembly experience. If you have/had any trouble at all or didn't, and would like to leave feedback and help us improve our assembly instructions you can.

Type this URL into your browser:

goo.gl/6enZji

ENJOY YOUR RIDE

Your bike should be ready to ride at this point. Time to enjoy the ride! If you have/had any trouble at all, please feel free to contact our team at:

(310) 982-2877

theteam@sixthreezero.com

RECORD YOUR SIXTHREEZERO'S INFO

BICYCLE SERIAL # _____

DATE OF PURCHASE _____

BATTERY SERIAL # _____

DEALER'S NAME _____

MODEL _____

DEALER'S PHONE _____

COLOR _____

DEALER'S EMAIL _____

PLEASE REGISTER YOUR SIXTHREEZERO AT [SIXTHREEZERO.COM/REGISTER](https://sixthreezero.com/register)

You must register your sixthreezero within 30 days of purchase for warranty to be valid

BICYCLE SERIAL LOCATION

01

Most Sixthreezero bicycles have their serial number stamped into the bottom of the frame below the bottom bracket. You'll need to lift it up to see underneath, or use a smart phone to take a photo (with the flash) of the underside. The serial number is located on the frame behind the chainring. Contact us if you're having trouble finding the serial number.



CONGRATULATIONS

You did it! Time to take your brand new bike for a spin.
Still have questions? We're happy to help.
Want to share your journey with us? We're happy about that, too.



SIXTHREEZERO

THETEAM@SIXTHREEZERO.COM

310.982.2877



SIX**THREE**ZERO
LOS ANGELES, CA

THETEAM@SIXTHREEZERO.COM
310.982.2877