

ASSEMBLY GUIDE

EVRYJOURNEY - 1, 3, 7, & 21 SPEED

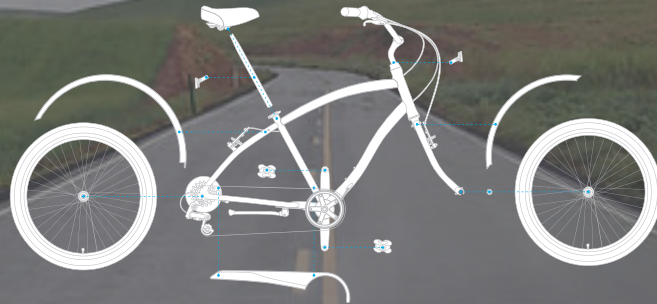

SIXTHREEZERO



OUR COMMITMENT

We want you to love your bike as much as we do.
If you run into any issues, no matter how small,
let us know and we'll take care of it.

SIXTHREEZERO

THETEAM@SIXTHREEZERO.COM

310.982.2877

MEET JACOB, OUR MECHANIC

Need assembly, repair, or installation assistance? He's your guy!
Want live help? Call or email to schedule an appointment.



MECHANICS@SIXTHREEZERO.COM

310.982.2877

A NOTE FROM
OUR MECHANIC

Welcome to the sixthreezero experience. Now for the fun part... the assembly.

I know, I know, we've all had to assemble something we've bought before - a tv stand, coffee table, possibly a grill or even a bike a time or two before. It's never fun, it never goes well, you always lose a nut or a screw and by the time you're done, you'd rather destroy whatever it is you've bought than actually use it. Well, I'm here to make sure that doesn't happen.

Assembly of a bike can be a fun, engaging, learning experience. Call up a friend, ask your spouse or child, don't

rush, and enjoy the process. Part of the fun in building your bike is telling people "I built it all by myself." I build bikes almost everyday and I always learn something new. I enjoy the process of building something from the ground up, and I hope you will too.

The instructions were written and designed by me, so if you have any suggestions please let me know!

Good luck,

A handwritten signature in black ink that reads "JACOB". The letters are stylized and connected, with a prominent flourish at the end of the word.

MECHANIC / SIXTHREEZERO

TOOLS YOU'LL NEED

Creating something wonderful with your own hands is basically the best feeling ever. We want you to have fun building your new bike, so there's only a few things you need to get started.



SCISSORS
(use to cut zip ties)



**8, 10, 13, AND 15MM
CRESCENT WRENCHES**
or use the multi-tool provided



**MALLET OR
HAMMER**



**4, 5, AND 6MM
ALLEN KEY**



**PHILLIPS HEAD
SCREWDRIVER**



**SCHRADER VALVE
BICYCLE PUMP**



**BICYCLE OR
AUTO GREASE**
recommended



**2
PENNIES**

WHAT'S IN EACH BOX?

Lay out all the parts in front of you.
Make sure you have all the parts before getting started.

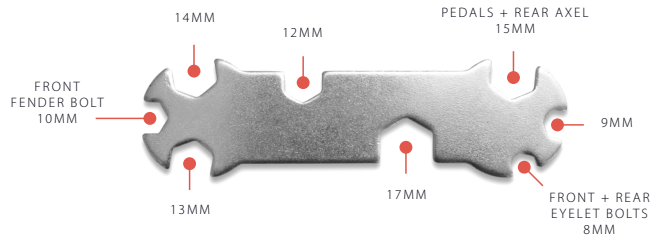



**HANDLE BAR / FRAME / REAR
WHEEL AND REAR RACK SET-UP**

Seat post is zip-tied to frame



**QUICK RELEASE
FRONT WHEEL**



FRONT REFLECTOR
pre-installed



**FRONT FENDER
+ STRUT**
fender strut pre-installed



**EXPERIENCE
BOOKLET**



**ASSEMBLY
GUIDE**



MULTI-TOOL



**4, 5, AND 6MM
ALLEN KEYS**



PEDALS



LOCK NUT CAP



SEAT



**QUICK RELEASE
SKEWER**



HARDWARE

BOX 3

BOX 4

BIKE PARTS REFERENCE

All the names of all the parts for your bike, all in one place.
Keep this handy during assembly, and everything will go just fine.

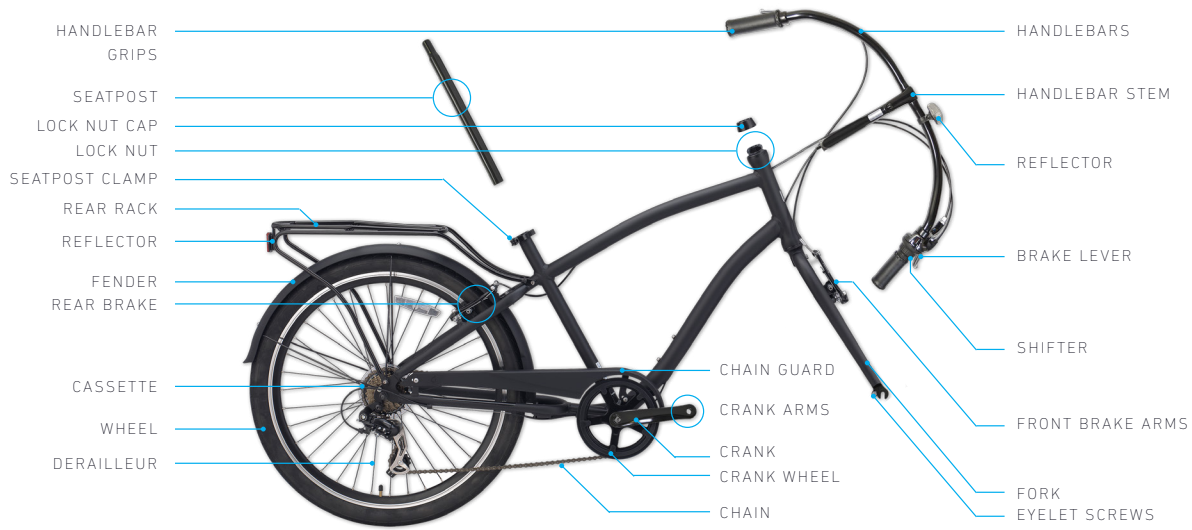

QUICK RELEASE SKEWER



PEDALS



SEAT

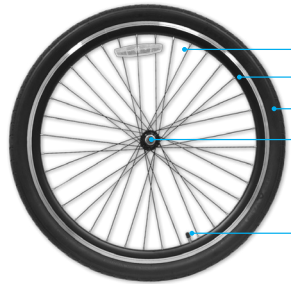

SPOKE
RIM
TIRE
AXLE

TIRE VALVE

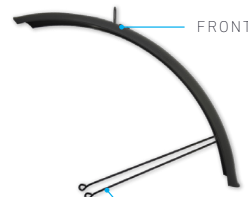

FRONT FENDER

FENDER STRUT

FRONT WHEEL, FENDER + REAR RACK

Parts required:



FRONT FENDER
+ STRUT



QUICK RELEASE
FRONT WHEEL



FRAME, REAR RACK
+ REAR WHEEL



QUICK
RELEASE SKEWER

Tools you'll need:



PHILLIPS
SCREWDRIVER



4MM
ALLEN KEY



10MM
MULTI-TOOL



(2) PHILLIPS
HEAD SCREWS
(pre-installed)



(2) WASHERS, NUT
AND LONG BOLT
(pre-installed)



(4) 4MM ALLEN
KEY SCREWS
(pre-installed)

01

Spin the front fork so that the the handlebars are pointing inwards.

CORRECT

The front brake is facing away from the bike body.



INCORRECT

The brakes are behind the fork.



02

Pinch front brake arms, pulling the metal tubing up and out until it is disengaged and the brake arms are open.



03

Locate the arrow on the wall of the tire and position the tire like the image below. With the arrow pointing forward, insert the wheel into the fork dropouts. The axle nuts will fall inside the fork entry.



04

Reattach the brake arms by connecting the metal tube as shown.



05



All of the components for the quick release skewer are attached out of the box.



Unscrew **QR5** and remove **QR4**. Do not remove **QR2** and **QR3** from the quick release handle **QR1**.

NOTE

Quick release skewer must be installed correctly to avoid bicycle damage and/or injuries.

06

Insert the quick release skewer through the hub opening on either side of the wheel, as shown below.



Slide quick release skewer completely through the hub.

07



Place **QR4** on the open side of the quick skewer, with the smaller end pointing inward.



08

Making sure the wheel is straight, attach **QR5** to **QR1** by compressing the spring completely. Hold the quick release lever in place and tighten **QR5** lightly.



09



Lift the lever up towards the fork. If the lever does not lock in place smoothly, loosen QR5 slightly and try again. It will take a small amount of strength, but that is normal.



NOTE

The lever should be tight enough to feel resistance at a 90° angle. Make sure the front wheel is securely tightened and properly aligned so there are no issues when you assemble the brakes.

10

Once the front wheel is secured, lower the kickstand and locate the front fender.



11



PHILLIPS
SCREWDRIVER



10MM
MULTI-TOOL



(2) WASHERS, NUT
AND LONG BOLT
(pre-installed)



FRONT FENDER
+ STRUT

Align the fender struts with the eyelets on the fork, so that the fender tab is pointing upwards. Slide the fender up through the back of the front tire.

Use a Phillips head screwdriver and the 10mm multi-tool to remove then install the fender tab screw and nut.

NOTE

Order from front to back:
LONG BOLT, WASHER, FORK, FENDER TAB, WASHER, NUT.

Remove the screws from the fork eyelets.

FENDER TAB



12



PHILLIPS
SCREWDRIVER



(2) PHILLIPS
HEAD SCREWS
(pre-installed)

Attach the screws into the struts and eyelets.

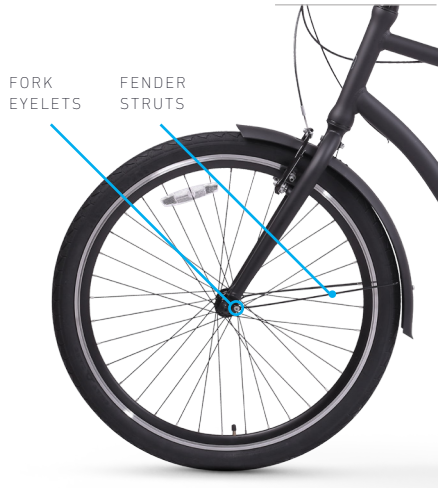

13



4MM
ALLEN KEY



(2) 4MM ALLEN
KEY SCREWS
(pre-installed)



REAR
RACK

Align the front rear rack arms to the eyelets on the frame below the seat. Use a 4mm allen key to tighten the screws and attach the rear rack to the frame.

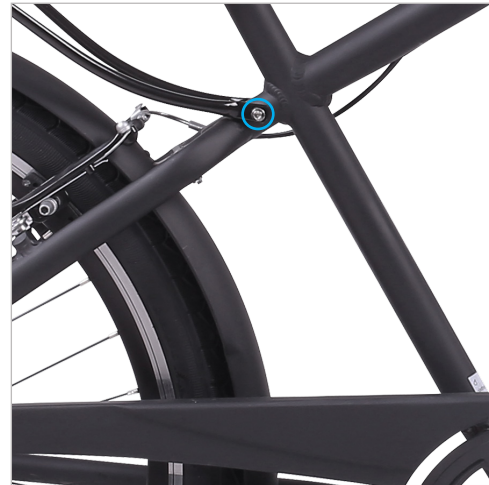

14



4MM
ALLEN KEY



(2) 4MM ALLEN
KEY SCREWS
(pre-installed)

Install the bottom rear rack arms to the frame in this order (from the frame out): Frame, fender strut, rear rack arms, and 4mm allen screws. Tighten with a 4mm allen key.



ORDER:

1. FRAME
2. FENDER STRUT
3. REAR RACK ARM
4. 4MM ALLEN KEY SCREW

NOTE

Repeat on both sides.

15



PHILLIPS
SCREWDRIVER



(2) PHILLIPS
HEAD SCREWS
(pre-installed)

Install the angled rear fender strut to the frame in this order (from the frame out): Frame, fender strut, and phillips head screws. Tighten with a phillips screwdriver.



ORDER:

1. FENDER STRUT
2. PHILLIPS HEAD SCREW

NOTE

Repeat on both sides.

HANDLEBAR, SEAT + PEDALS



HANDLEBAR



PEDALS



6MM
ALLEN KEY



13MM + 15MM
MULTI-TOOL



BICYCLE
PUMP



LOCK
NUT CAP



SEAT



PHILLIPS
SCREWDRIVER



BICYCLE OR
AUTO GREASE

15



LOCK NUT CAP



HANDLEBAR

Place the lock nut cap in between **ST1** and **ST2**.



ST1 STEM

LOCK NUT CAP

ST2 LOCK NUT/
HEAD TUBE

Line up the stem, frame, and front wheel, then tighten the handlebar stem bolt.

HANDLEBAR
STEM BOLT



NOTE

Straightening the stem, frame, and front wheel will ensure that your handlebars and wheel are properly aligned.



16



Loosen handlebar adjustment bolt using the 6mm Allen key. Change the angle of the handlebars to your liking. Riders typically prefer their grips parallel to the ground.



17

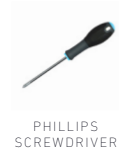

Straighten the reflector so that it points forward.



Adjust the position of the front reflector by loosening the screw on the bracket.



18



BICYCLE OR
AUTO GREASE

Apply great to seat lever, then open seat post clamp. Holding the seat post firmly, insert into seat post tube until the top is level with your waist.

Close the seat post clamp lever.

CAUTION

Make sure not to drop seat post into the frame.



19



13MM
MULTI-TOOL

Place the seat onto the seat post, using the 13mm multi-tool to tighten the nuts under the seat.



20



BICYCLE OR
AUTO GREASE



15MM
MULTI-TOOL



PEDALS

Apply grease to threading on both pedals.

Select the pedal stamped R and locate the right side of the bike (with the chain and chain guard). Align threading with the right crank arm, turning the pedal clockwise to tighten it.

Locate the pedal stamped L and align with the left crank arm. The left side pedal is reverse-threaded, tightening in a counterclockwise direction.

Hand tighten accordingly, then follow up by tightening both pedals with the 15mm multi-tool or crescent wrench.



21



BICYCLE PUMP

Pump air into the tires to **PSI40-65MAX**, as recommended on the sidewall of the tire.



22

Sit on the bike and check the angle formed by your knee.

If your knee forms the incorrect angle, use the seat post clamp lever to raise the seat until you have a subtle bend or achieve a comfortable height.

CORRECT



INCORRECT



BRAKE ASSEMBLY

DIAGRAM

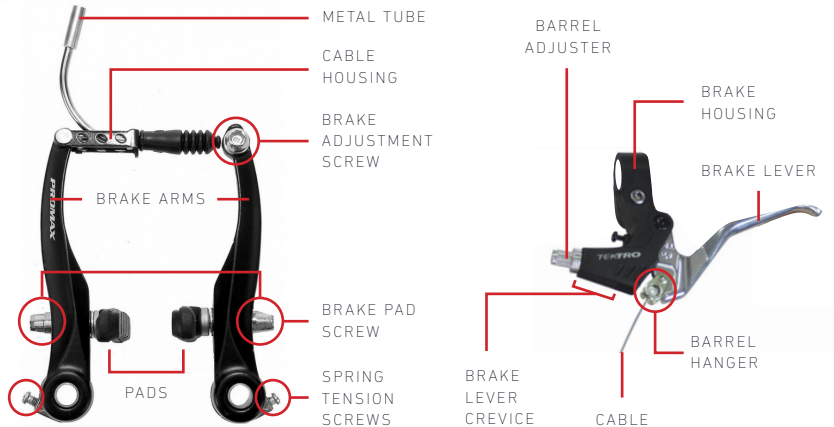

TOOLS REQUIRED

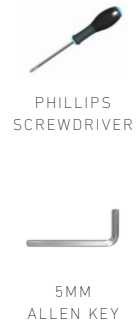

WATCH ASSEMBLY VIDEOS ON OUR YOUTUBE CHANNEL, [HTTPS://SIXTHREEZERO.COM/PAGES/ASSEMBLY](https://sixthreezero.com/pages/assembly)

NOTE

Only follow steps 1-9 if your brake cable is not attached to the bicycle.

If your brake cable is attached, skip to step 10.



ATTACHED
BRAKE CABLE

01

There are two ends to the brake cable.

One end has a barrel attached, while the other end has an open piece of cable.

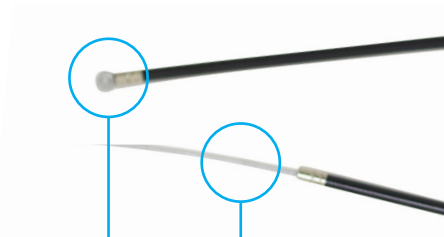

BARREL

CABLE

02

Attach the brake cable to the brake lever by squeezing the lever and inserting the barrel into the barrel hanger.



BARREL
ADJUSTER

BARREL
HANGER

03

Pull on the cable and slide it through the narrow crevice that runs along the brake lever.



BRAKE
LEVER CREVICE

04

Slide the cable housing up toward the brake lever until it fits snug inside the barrel adjuster.



BARREL ADJUSTER

05

Turn the lock ring on the barrel adjuster clockwise, tightening the barrel to prevent any loose movement.



LOCK RING

06

Insert the open end of the brake cable into the larger end of the metal tube.

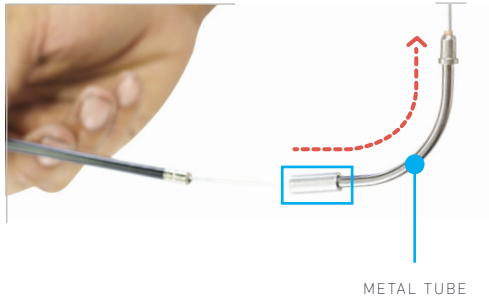

07

Slide the metal tube up the brake cable until the housing fits snugly into the cable housing.

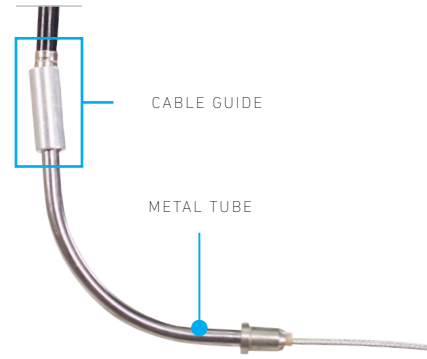

08

Slide the exposed end of the metal into the metal tube hanger, located on the left brake arm. Make sure the metal tube is hooked securely inside the hanger.



LEFT
BRAKE ARM

METAL TUBE
HANGER

END OF
METAL TUBE

09



5MM ALLEN KEY

Using a 5mm Allen key, loosen the brake cable adjustment screw. Slide remaining brake cable between the right brake arm and the adjustment screw.

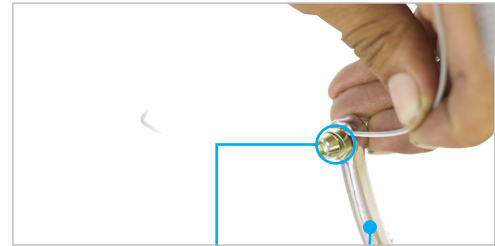

BRAKE ADJUSTMENT SCREW

RIGHT BRAKE ARM

10

Pull the cable outward, reducing the distance between the brake pads and the rim by about 1/4 inch on both sides. Retighten the adjustment screw.



CABLE

11



5MM
ALLEN KEY

Make sure the pads are evenly lined up with the rim. If the pads rub against the tire, they are too high; if they don't make full contact with the rim when braking, they are too low.

Adjust the positions by holding the brake pad with one hand and loosening the nut on the back with a 5mm Allen key.



ADJUST WITH
5MM ALLEN KEY

12

If one pad seems to run against the rim while the other still has plenty of space, you will need to center the brakes. To do this, adjust the spring tensioner screws located at the base of each brake arm.

Tightening the screw on the right brake arm pushes the right brake pad away from the rim, and the left brake pad towards the rim.

Loosening the right screw allows the right brake pad to move closer to the rim, and the left brake pad away from the rim.

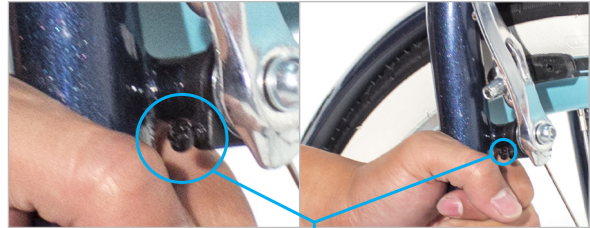

SPRING
TENSIONER SCREW

3 SPEED DERAILLEUR TUNING

DIAGRAM



TOOLS REQUIRED



PHILLIPS
SCREWDRIVER



10MM
MULTI-TOOL

01

Check and adjust gears. Shift into 2nd gear by twisting the shifting unit. The shifter has an outer exterior that resembles a gold ball, that us the part that turns.



02

Look through the window in the back of the rear hub. If the yellow dot is within the parallel lines and arrows, your bike is properly adjusted.



03



10MM
MULTI-TOOL

If not adjusted correctly, loosen the lock nut with a 10mm crescent wrench, and turn the adjustment barrel in either direction. The yellow dot will start to move.



04

Tightening the adjustment barrel in, moves the yellow dot away from the rear wheel.



05

Untightening the adjustment barrel out moves the yellow dot in towards the rear wheel.



06



10MM
MULTI-TOOL

Center the yellow dot within the parallel lines. Once the yellow dot is within range, tighten down the nut using the 10mm crescent wrench.



7 SPEED DERAILLEUR TUNING

DIAGRAM

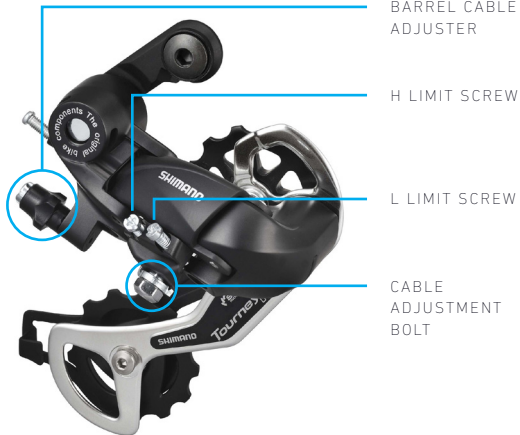

BARREL CABLE
ADJUSTER

H LIMIT SCREW

L LIMIT SCREW

CABLE
ADJUSTMENT
BOLT

TOOLS REQUIRED



PHILLIPS
SCREWDRIVER



9MM
MULTI-TOOL

01

To adjust the rear derailleur, first twist the shifter until the number **7** is highlighted on the shift knob.



02

Rotate pedals until the chain falls into the smallest cog.



03

Turn the barrel adjuster located on the rear derailleur clockwise until it stops.



BARREL
ADJUSTER

04

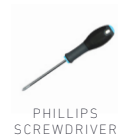

If the chain still hasn't reached the smallest cog, then you will need to adjust the "High Gear" limiting screw located on the derailleur (indicated by the letter **H**).

With a Phillips screwdriver, gradually turn the screw counterclockwise 1/4 turn at a time while rotating the pedal until the chain falls onto the smallest cog.



NOTE

The "High Gear" limiting screws are very sensitive. We recommend using only 1/4 turn at a time, in case you have to revert back to it's original position.

05



Now adjust the cable tension, which controls how your bike will shift. Using a 9mm crescent wrench or the multi-tool, loosen the cable adjustment screw and pull on the cable. While keeping tension on the cable, tighten the cable adjustment screw.



06

Rotate the pedals and try to shift between gears. If it doesn't shift from 7th to 6th gear in one click, then the cable needs to be tightened. To tighten the cable, twist the barrel adjuster counterclockwise 1/4 turn at a time until it is able to shift from 7th to 6th gear in one click.

Shift through the gears from 7th to 1st, then back from 1st to 7th. If the gears feel sluggish when shifting from 7th to 1st, tighten the cable by turning the barrel adjuster counterclockwise. If shifting feels fine from 7th to 1st, but sluggish from 1st to 7th, loosen the cable by turning the barrel adjuster clockwise.

Continue to adjust the derailleur cable until you are able to shift between each gear with a single click.



NOTE

Each gear should shift with a corresponding "click" sound.

21 SPEED DERAILLEUR TUNING

DIAGRAM

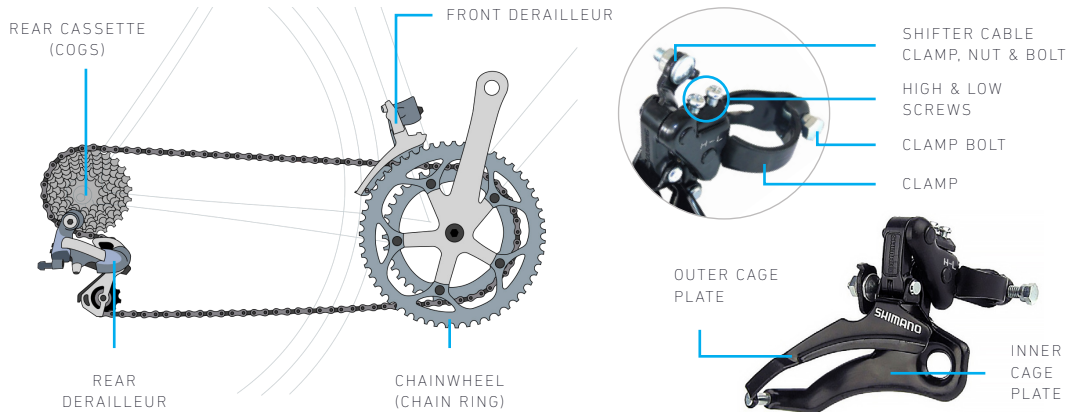

HAVING TROUBLE? WANT LIVE HELP? CALL 310.982.2877 OR EMAIL TEAM@SIXTHREEZERO.COM.

NOTE

We tune every bike before packaging, but I would still recommend checking the tuning. It's possible that they may need to be readjusted after being shipped to you. These instructions are designed to help if your bike needs a little extra work.

If you don't feel comfortable working on your bike, we suggest taking it to your local bike shop for final assembly.

TOOLS REQUIRED



PHILLIPS
SCREWDRIVER



9MM
MULTI-TOOL



5MM
ALLEN KEY



MALLET OR
HAMMER

FRICTION SHIFTER

The front shifter is a "Friction" shifter. This just means that there is no specific level set for each gear. You will be shifting generally by "feel", so when you twist this shifter, make sure to pay attention to see if your gear is shifting up or down.

We do this for two reasons:

For the majority of commuter and recreational type riding, the rider won't want to be shifting the front shifter a lot.

It allows smoother shifting and allows more of a selection than an Index shifter.



CAUTION

Please be careful with the derailleur cage as it has tension that causes the cage to pull back into the frame when attached to the shifting cable.



2 PERSON ASSEMBLY RECOMMENDED BUT NOT REQUIRED

We recommend you have a helper with you. It's not necessary, but it would make shifting in these steps a whole lot easier.

Besides, are you going to get up and get your own tools?

Let's start.

DERAILLEUR POSITION

01

Check your bike's tuning by taking it for a test ride. Shift the front derailleur up and down to check each gear while riding. If you hear any rubbing coming from the chain hitting the derailleur in any of the gears, you will need to tune the front derailleur.



02

Shift the front derailleur to the smallest gear.



03



9MM
MULTI-TOOL

Use a 9mm wrench/socket to loosen the nut that clamps the shifting cable to the front derailleur. This will disconnect the shifting cable from the front derailleur.

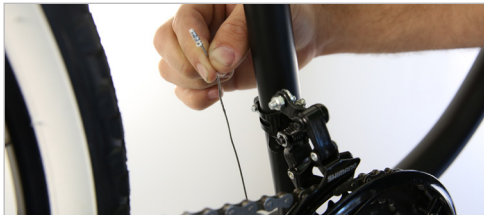

04



2 PENNIES

Lift the chain and pull the cage away from the bike to place a penny in between the outer cage and the largest chainwheel. If you can fit two pennies, then your front derailleur is too high. If the penny fits snugly in between the outer cage and the chainwheel, you can move to step 6.



05

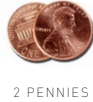

Untighten the clamp with a 9mm wrench/socket a quarter turn at a time until you are able to tap the derailleur slightly up and down without it falling completely down the seat tube. While still pulling the cage forward, grab a penny and place it above the largest chainwheel. Adjust the height of the derailleur cage so it sits above the penny. With a mallet/hammer and the allen key, you can slightly tap the derailleur up or down based on its original position. Reference the bottom right image as an example. Now tighten the cage in place with a 9mm wrench/socket.

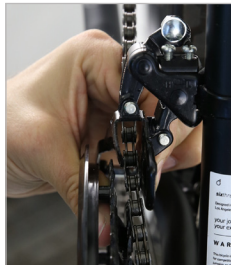
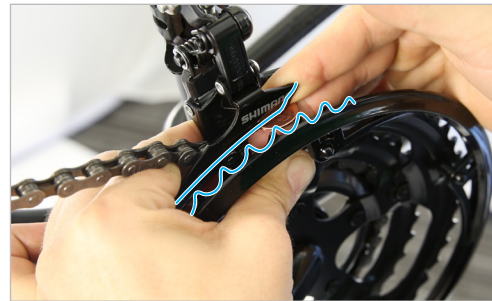

06

Once the height is set, we must check the angle of the cage. Lift the chain and pull the cage forward and view the cage from above. The inside of the outer cage plate must be parallel to the largest chainwheel. If your outer cage plate is parallel to the largest chainwheel, you can move to step 8.

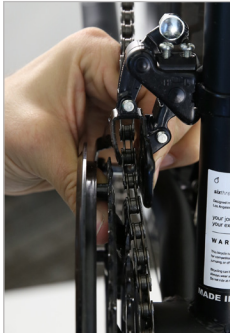

07



9MM
MULTI-TOOL

If your outer cage plate is NOT parallel to the largest chainwheel, untighten the clamp a quarter turn at a time until you are able to slightly move the derailleur.



08



Based on the angle, tap on the back or the front of the cage after every turn until it moves slightly.

Tap the cage left or right to align the cage plate and the largest chainwheel. Recheck the angle to make sure that they are parallel. Now tighten the cage in place with a 9mm wrench/socket.

NOTE

If you untighten the derailleur too much, it will potentially offset the height of the derailleur causing a need to repeat step 5.



09



9MM
MULTI-TOOL

Pull the shifting cable up, align it behind the clamping nut, and make sure to pull out any slack in the cable. Tighten the shifting cable to the derailleur by using a 9mm wrench/socket.



NOTE

Derailleurs work off of tension, and this is the reason that they are designed with High and Low Limiter screws. The High and Low Limiters essentially act as boundaries so that no matter how much tension you put into or take off the shifter cable, the derailleur will not go past the largest or smallest gears. The High (H) screw is the limiter for the largest gear, and the Low (L) screw is the limiter for the smallest gear.

COUNTERCLOCKWISE

Turning the **L & H** counterclockwise shortens the range where the derailleur cage can travel.

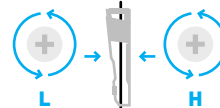

CLOCKWISE

Turning the **L & H** clockwise increases the range where the derailleur cage can travel.

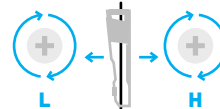

LIMITER SCREWS

10

Now, let's check the H limit screw. Begin by shifting the derailleur to 3rd gear. While turning the pedals, shift into 3rd gear. If the chain does not fall off the largest chain-wheel when shifting into 3rd gear, the H limit screw is close to proper positioning.



11

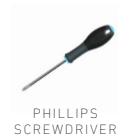

Reference the bottom left image below to check if the derailleur is properly adjusted. If it matches the images, please move forward to Step 12. Looking through the front of the derailleur cage, decide whether the chain is too close to the inner or outer cage plates. If the chain is too close to the outer cage plate, turn the H screw clockwise a quarter turn at a time until it is centered. If the chain is too close to the inner cage plate (closer than the outer cage plate or it is rubbing), then turn the H screw counter-clockwise a quarter turn at a time until it is centered.

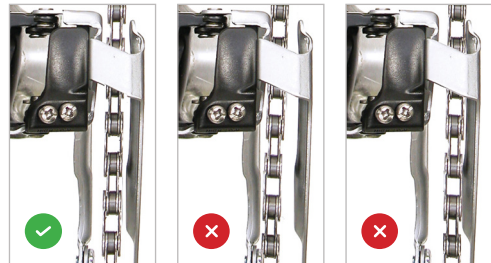

12

Now, let's check the L limit screw. Begin by shifting the derailleur to 1st gear. While turning the pedals, shift into 1st gear. It may take more than 1 click. If the chain does not fall off the smallest chainwheel after shifting from 2nd to 1st, the L limit screw is close to proper positioning.



13



Reference the image below on the left, if the chain is centered in between the inner and outer cage plates, you can move on to step 14, Micro Adjustments. If the chain is NOT centered in between the inner cage, you will need to use a Phillips head to center the inner walls of the cage to the chain. Looking overhead at the cage and inspect its current position.

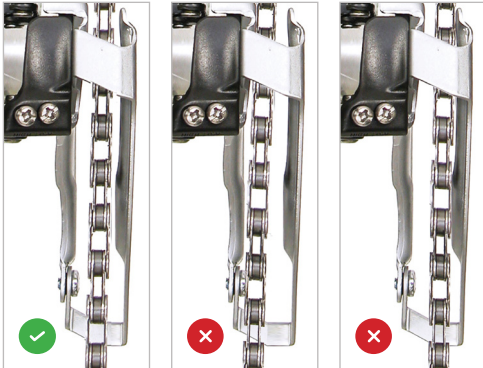

14

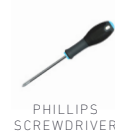

Based on the screws original position, take note of the amount of quarter turn rotations given in either direction to the L screw, until the inner and outer cage plates are centered. If the outer cage plate is too far in and rubbing against the chain, you have to turn the L screw counter-clockwise. If the inner cage plate is too far out and rubbing against the chain, you have to turn the L screw clockwise.



CABLE TENSION AND SHIFTING

15

Now that you have adjusted the limiter screws, let's check each gear to make sure that the derailleur is shifting correctly. Shift from 1st gear to 2nd, 2nd to 3rd gear, and from 3rd to 1st gear. If you can pedal the bike in each gear without hearing rub, and it's shifting up and down without resistance or lag, the front derailleur is properly adjusted. If not, we will need to do some minor adjustments with the barrel adjuster.



16

Locate the barrel adjuster located on the front shifter where the cable comes out of the shifter. Note/Explanation: The barrel adjuster will change the amount of tension on the shifting cable. This helps the derailleur move up and down the gears. Turn the barrel adjuster counter-clockwise a quarter turn at a time while pedaling the bike. Keep checking for rub/lag on each gear until it disappears. If the rub/lag persists, please feel free to contact one of our mechanics to help you troubleshoot this last step.

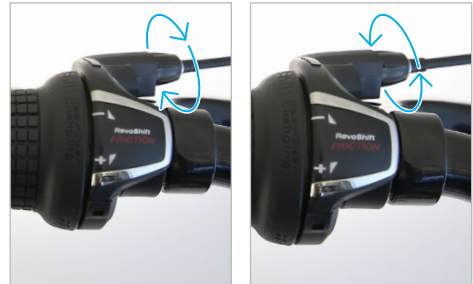

17

Your front derailleur should be ready at this point. Finish up any other adjustments/assembly on the rest of your bike, and enjoy the ride! If you have/had any trouble at all, please feel free to contact our team at:

(310) 982-2877

theteam@sixthreezero.com

SURVEY

Tell us about your assembly experience. If you have/had any trouble at all or didn't, and would like to leave feedback and help us improve our assembly instructions you can.

Type this URL into your browser:

goo.gl/6enZji

CONGRATULATIONS

You did it! Time to take your brand new bike for a spin.

Still have questions? We're happy to help.

Want to share your journey with us? We're happy about that, too.



SIXTHREEZERO

THETEAM@SIXTHREEZERO.COM

310.982.2877



SIX**THREE**ZERO
LOS ANGELES, CA

INFO@SIXTHREEZERO.COM
310.982.2877