

 *sixthreezero*

ASSEMBLY GUIDE



Body Ease Women E Bike



OUR COMMITMENT

We want you to love your bike as much as we do.
If you run into any issues, no matter how small,
let us know and we'll take care of you.

SIXTHREEZERO
THETEAM@SIXTHREEZERO.COM
310.982.2877



REGISTER YOUR WHEELS

Register your e-bike so we can help you with any claims.

VISIT THE LINK BELOW

<http://www.sixthreezero.com/pages/register-your-bike>

Need Help? Please click or call the team@sixthreezero.com or (310) 982-2877

TOOLS YOU'LL NEED

Creating something wonderful with your own hands is basically the best feeling ever. We want you to have fun building your new bike, so there's only a few things you need to get started.

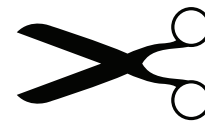

SCISSORS
(TO CUT ZIP TIE)



ALLEN KEYS



MULTI-TOOL



PHILLIPS SCREWDRIVER



BICYCLE TIRE PUMP

Need Help? Please click or call the team@sixthreezero.com or (310) 982-2877

WHAT'S IN EACH BOX?

Layout all the parts in front of you.
Make sure to **remove all packaging** before you get started.

Need Help? Please click or call the team@sixthreezero.com or (310) 982-2877

BICYCLE BOX

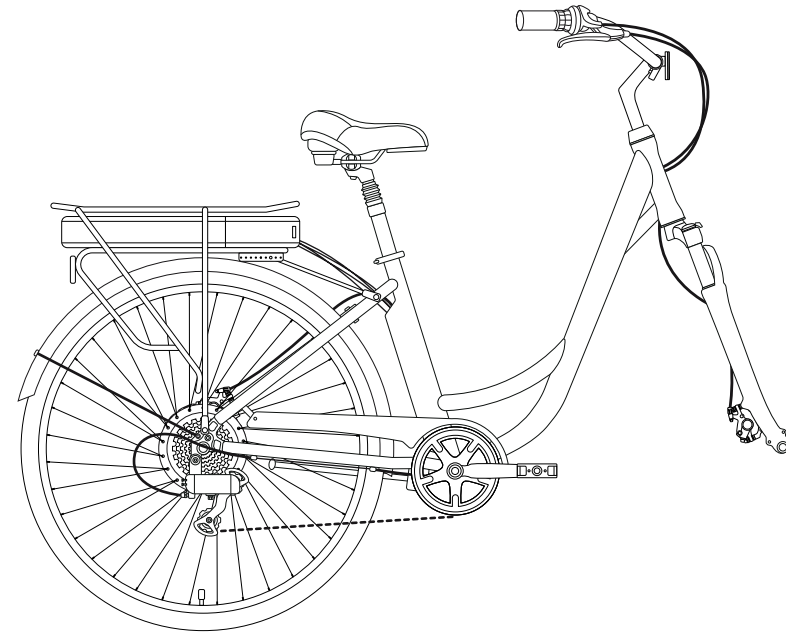

HANDLE BAR / FRAME / REAR
WHEEL AND REAR RACK SET-UP

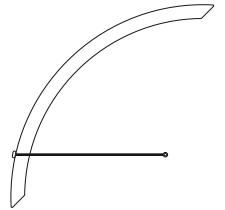

FRONT FENDER + STRUT

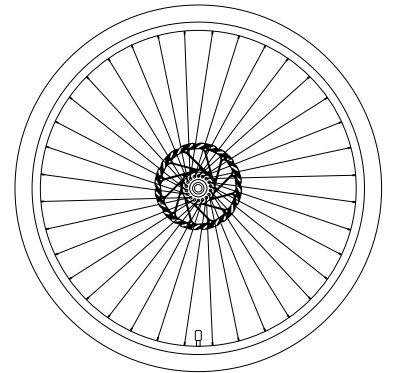

FRONT WHEEL
WITH QUICK RELEASE

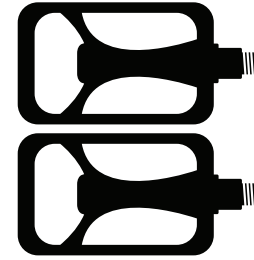
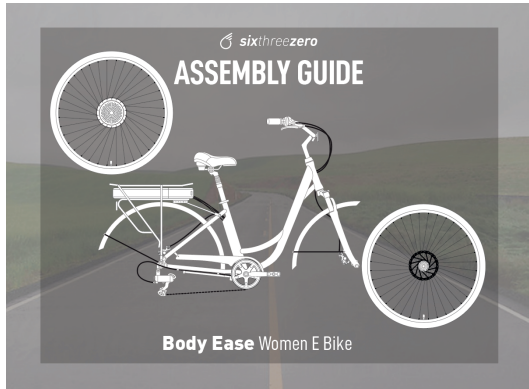

PEDALS

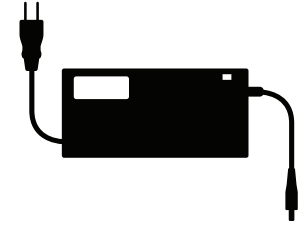

BATTERY CHARGER

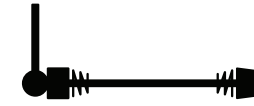

QUICK RELEASE



MULTI-TOOL



4,5 & 6mm ALLEN KEYS

FRONT WHEEL

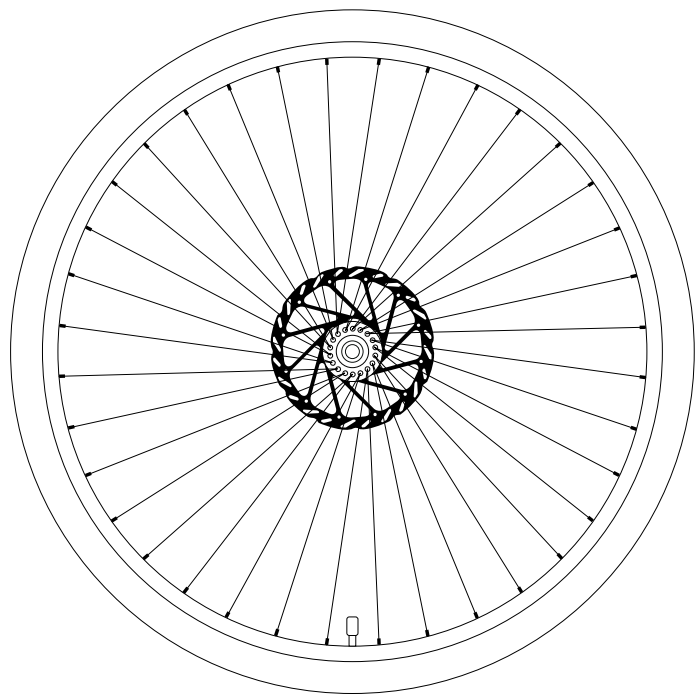

01



NEED HELP?

Use camera to scan
for video instructions

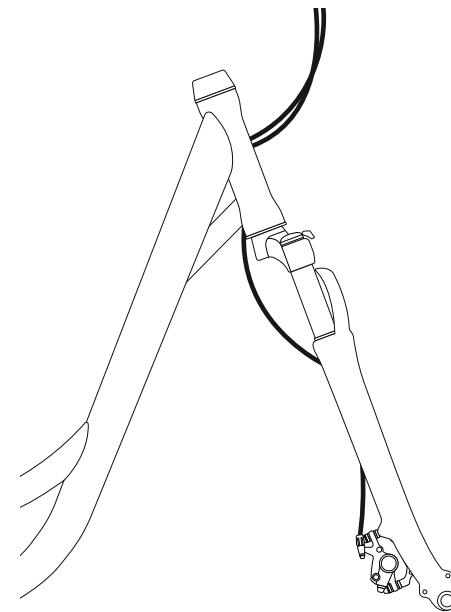
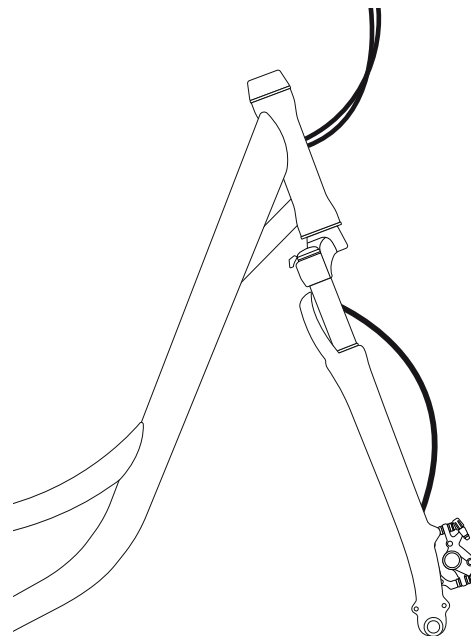

Need Help? Please click or call the team@sixthreezero.com or (310) 982-2877

02



NEED HELP?

Use camera to scan
for video instructions

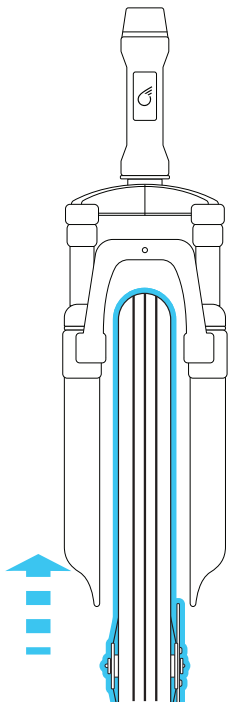

03



NEED HELP?

Use camera to scan
for video instructions

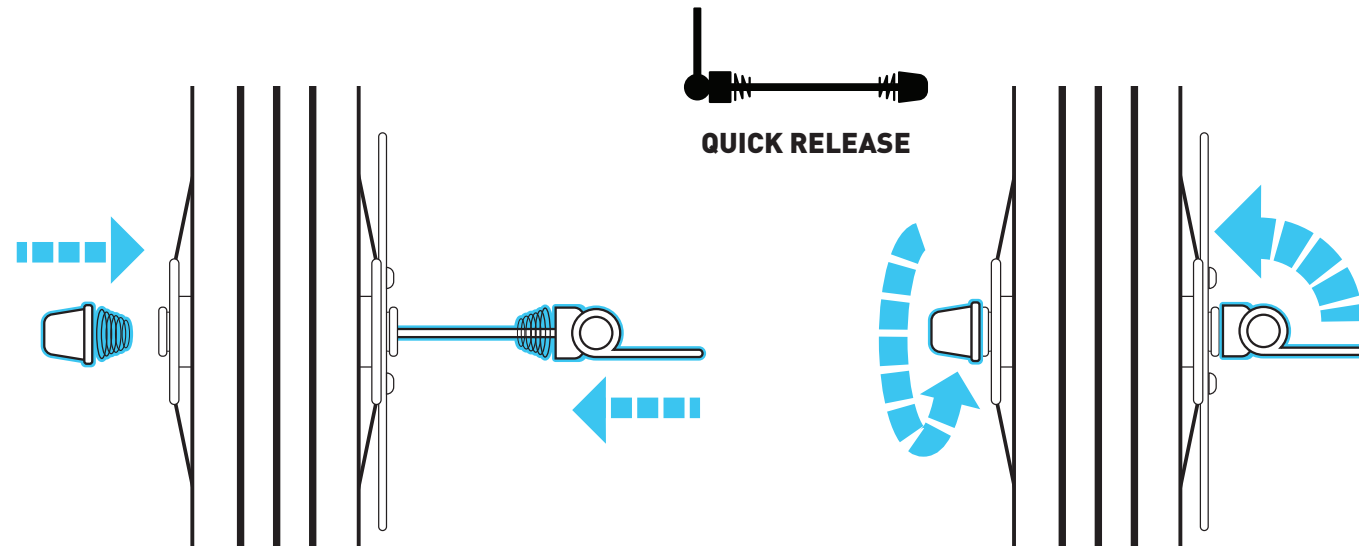

Need Help? Please click or call the team@sixthreezero.com or (310) 982-2877

FENDERS

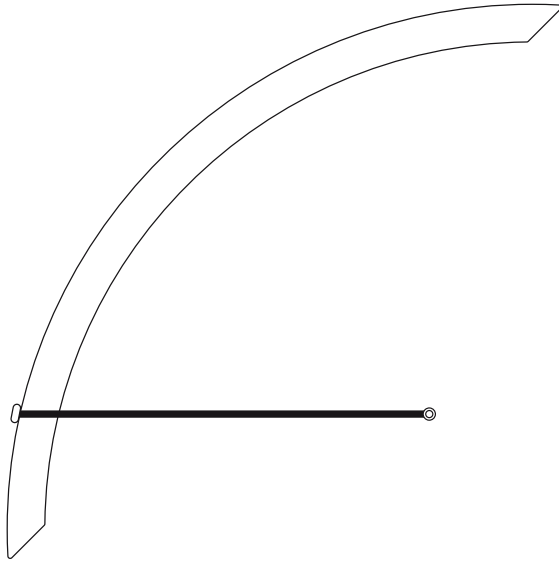

04



NEED HELP?
Scan for Rear Rack
installation Video



PHILLIPS SCREWDRIVER



MULTI-TOOL

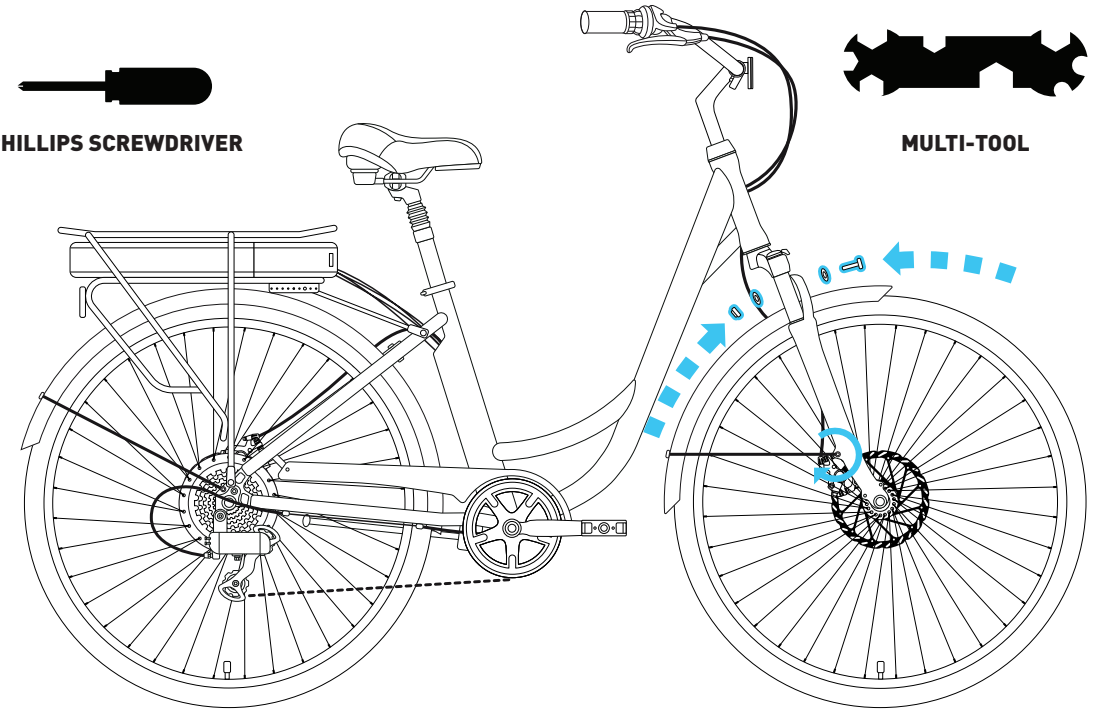

Need Help? Please click or call the team@sixthreezero.com or (310) 982-2877

05



NEED HELP?

Use camera to scan
for video instructions

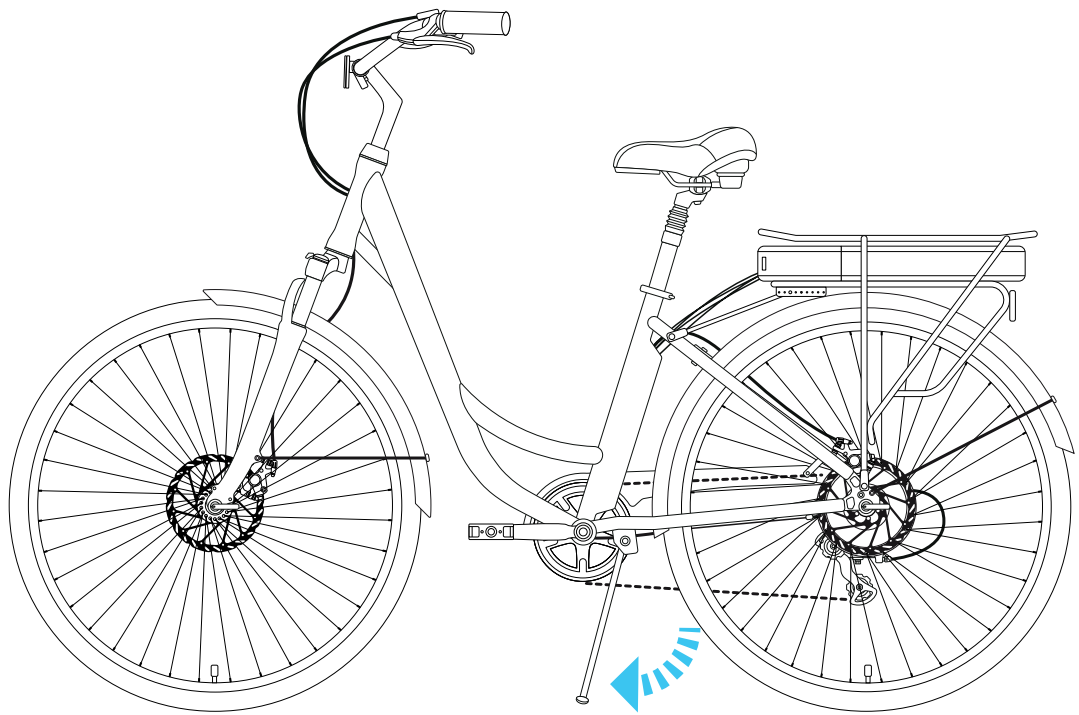

***Put kickstand down so bike will stand on its own.**

HANDLEBARS

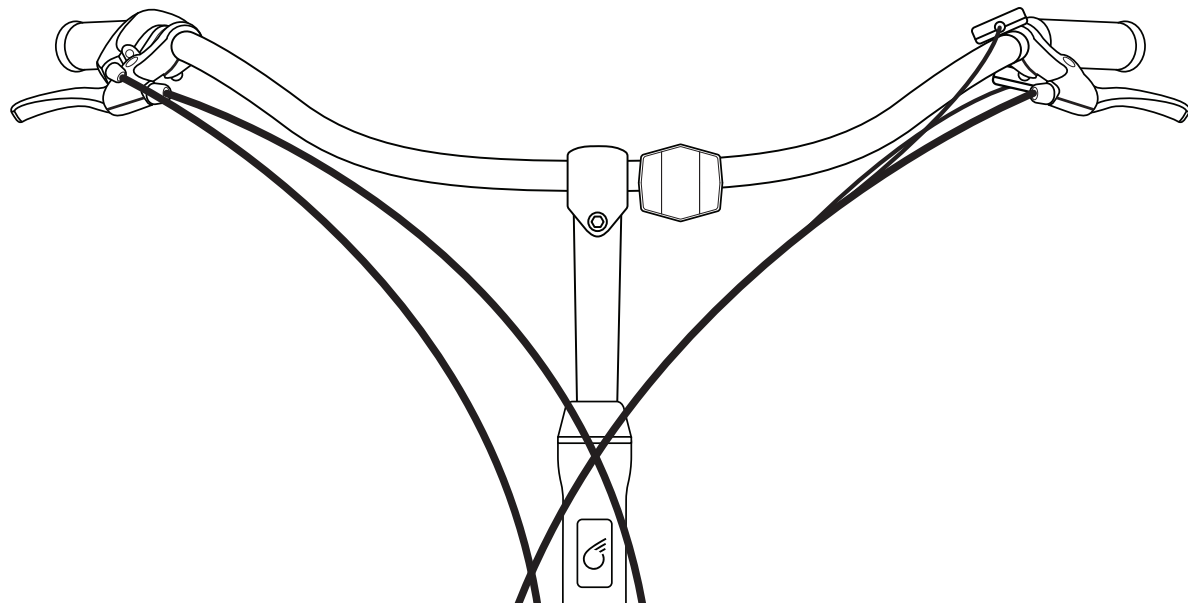

06



NEED HELP?

Use camera to scan for video instructions

07



NEED HELP?

Use camera to scan for video instructions

08



NEED HELP?

Use camera to scan for video instructions

09



NEED HELP?

Use camera to scan for video instructions

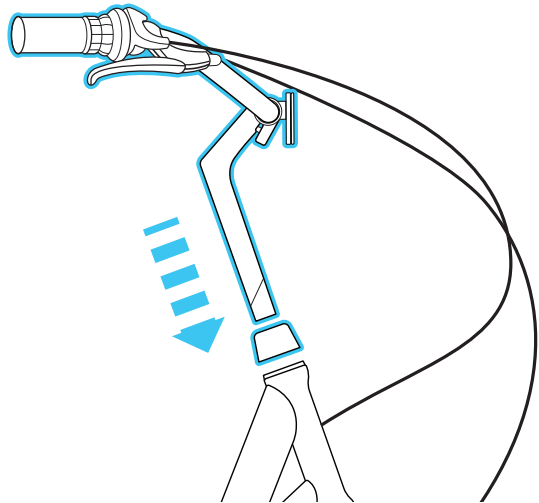

ALLEN KEYS

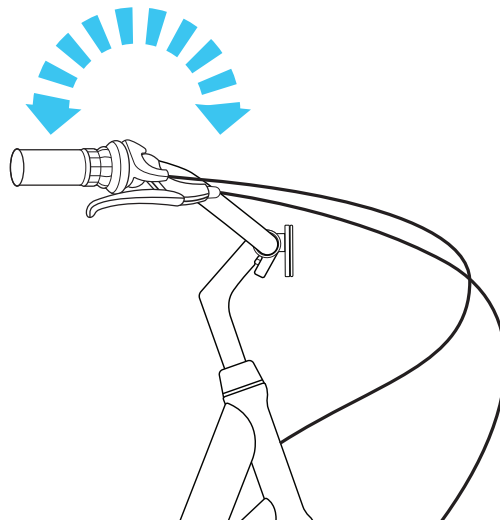
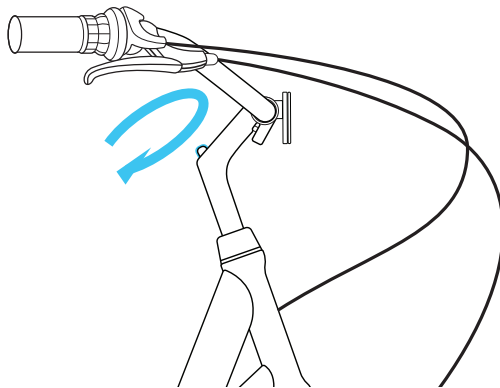

ALLEN KEYS

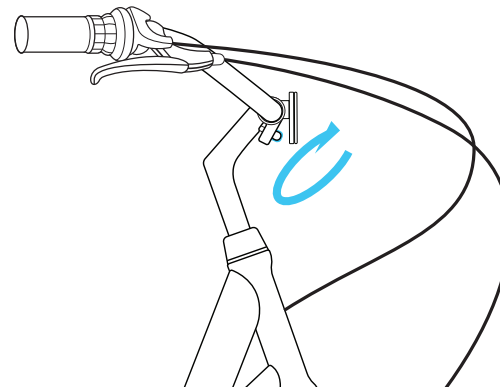

Need Help? Please click or call the team@sixthreezero.com or (310) 982-2877

SEAT

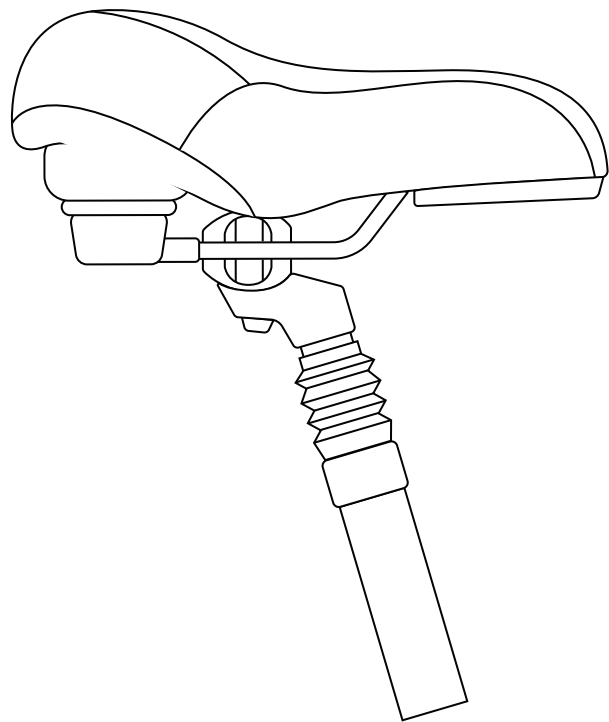

10



NEED HELP?

Use camera to scan
for video instructions

11



NEED HELP?

Use camera to scan
for video instructions

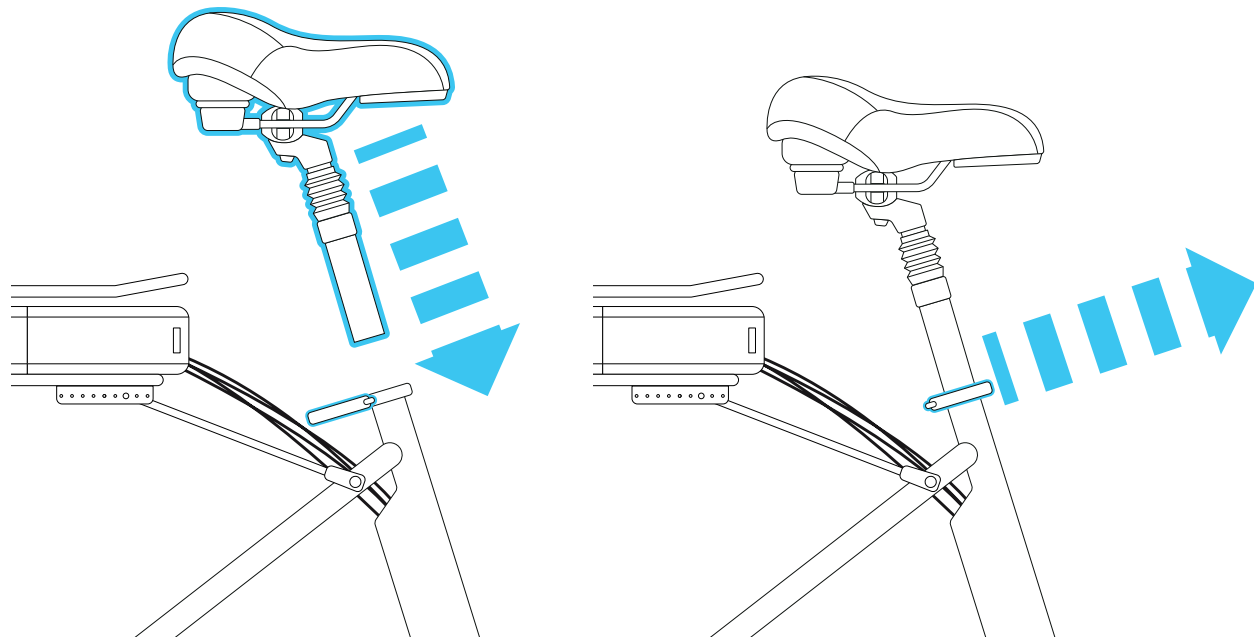

Need Help? Please click or call the team@sixthreezero.com or (310) 982-2877

PEDALS

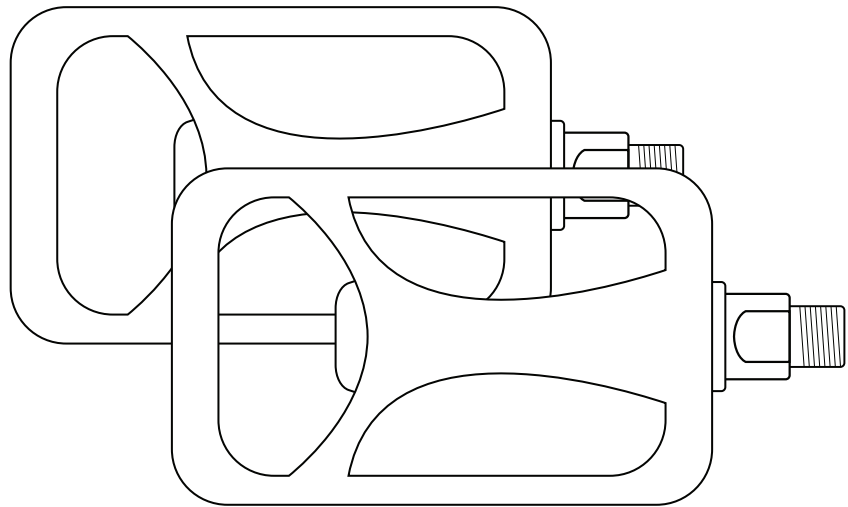

12



NEED HELP?

Use camera to scan
for video instructions

13



NEED HELP?

Use camera to scan
for video instructions

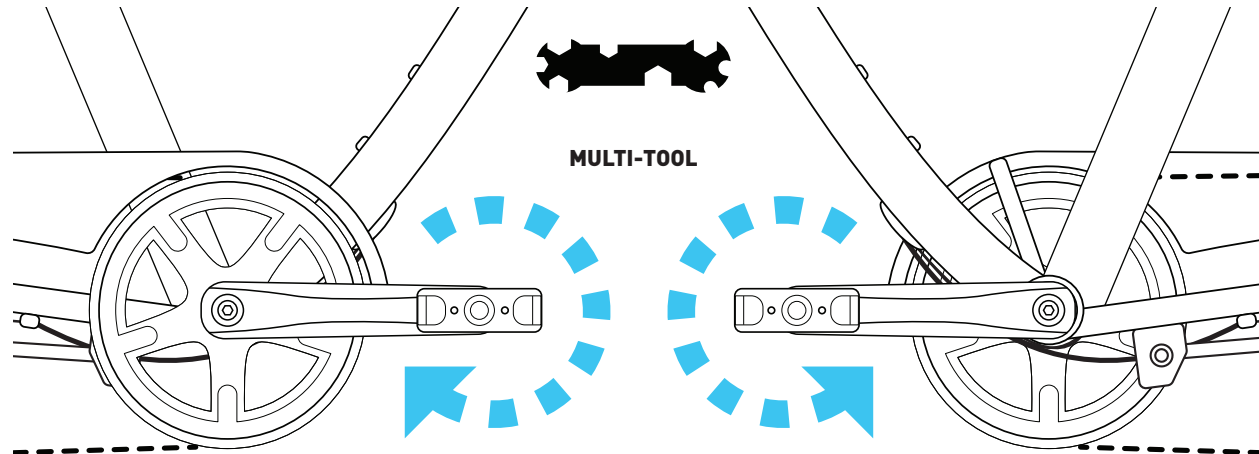

RIGHT PEDAL

LEFT PEDAL

CAUTION:

*Left Pedal has left hand threads.
Turn counterclockwise to install.*

BATTERY



14



NEED HELP?

Use camera to scan for video instructions

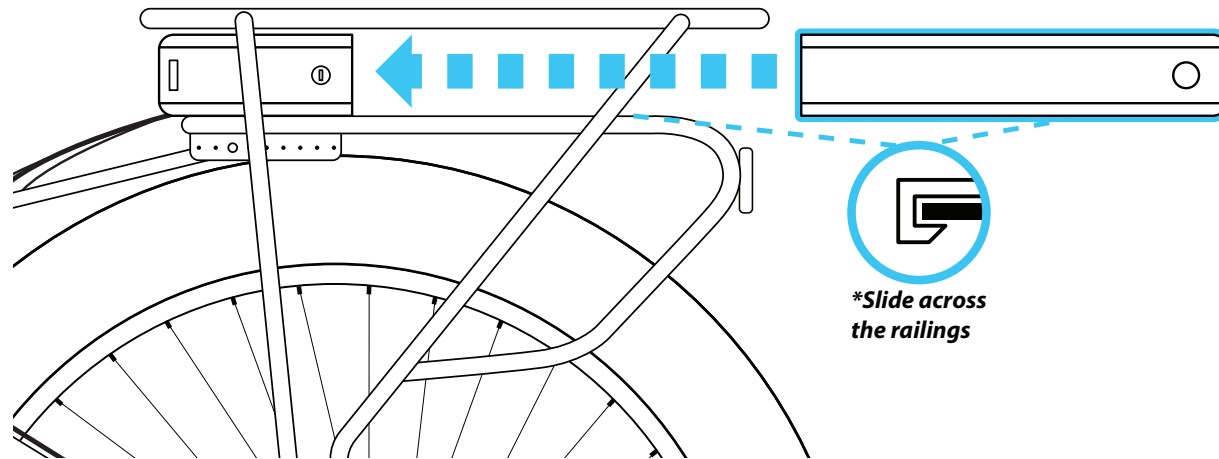

Need Help? Please click or call the team@sixthreezero.com or (310) 982-2877

15



NEED HELP?

Use camera to scan for video instructions

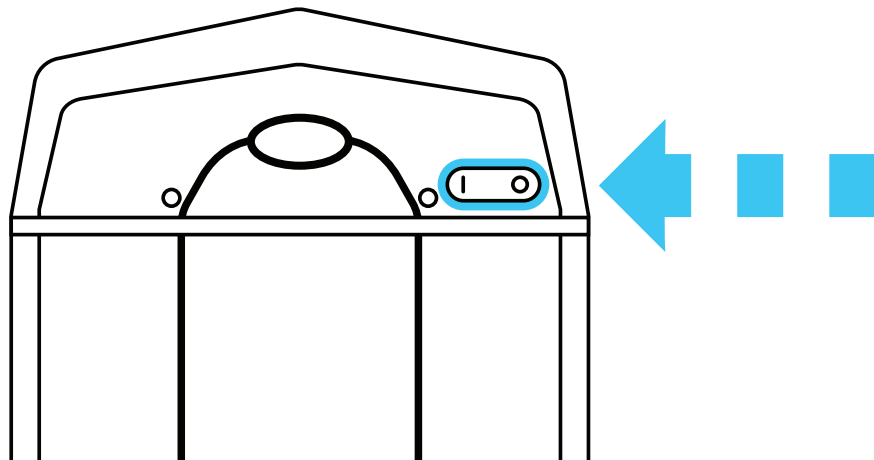

ON  **OFF**

Need Help? Please click or call the team@sixthreezero.com or (310) 982-2877

16



NEED HELP?

Scan for Display Monitor User's Manual

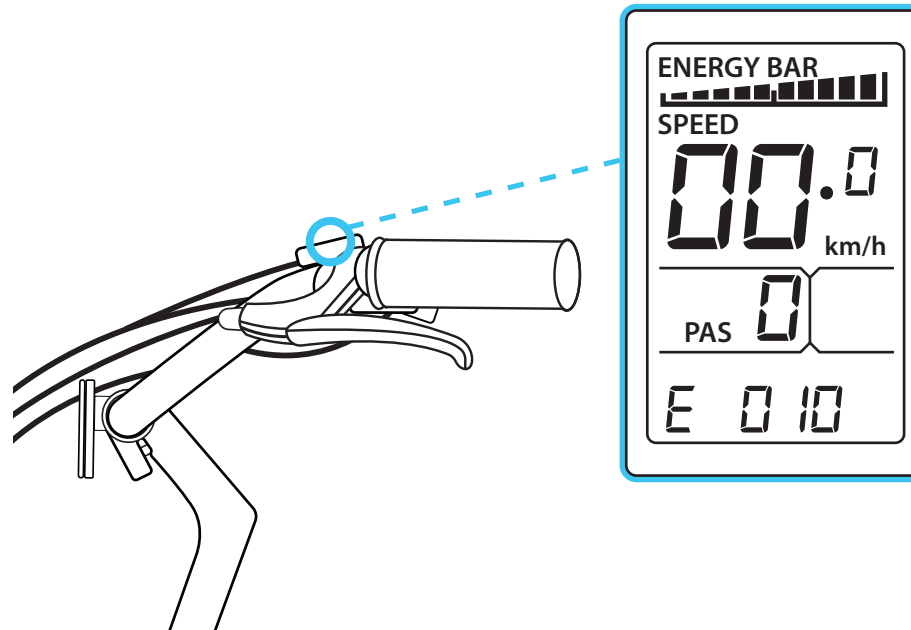

Need Help? Please click or call the team@sixthreezero.com or (310) 982-2877

BATTERY CHARGER

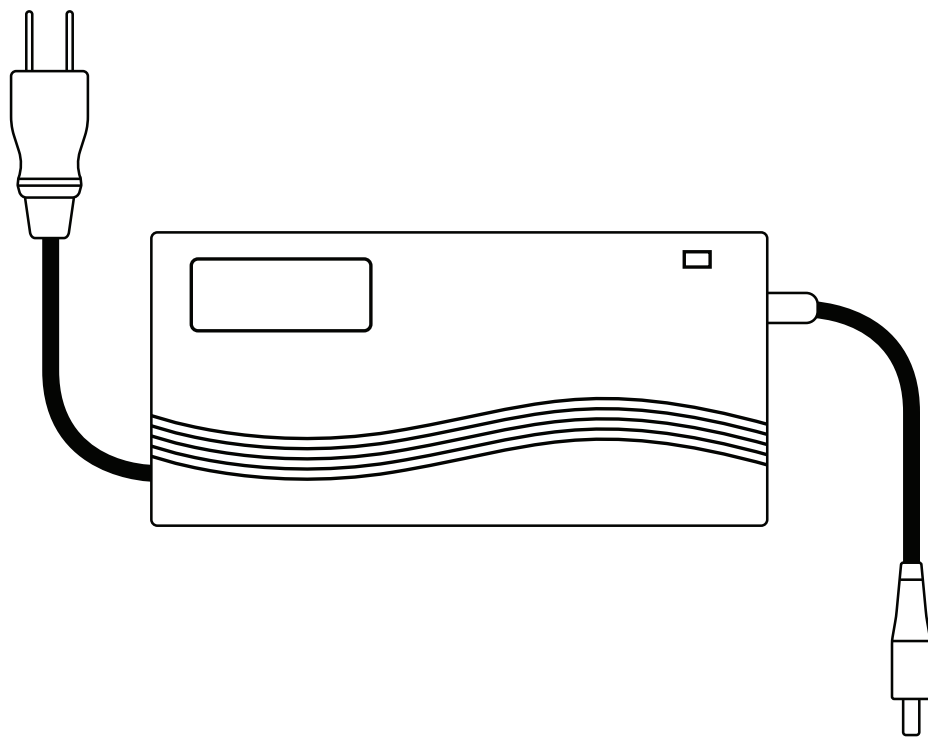

17



NEED HELP?

Use camera to scan for video instructions

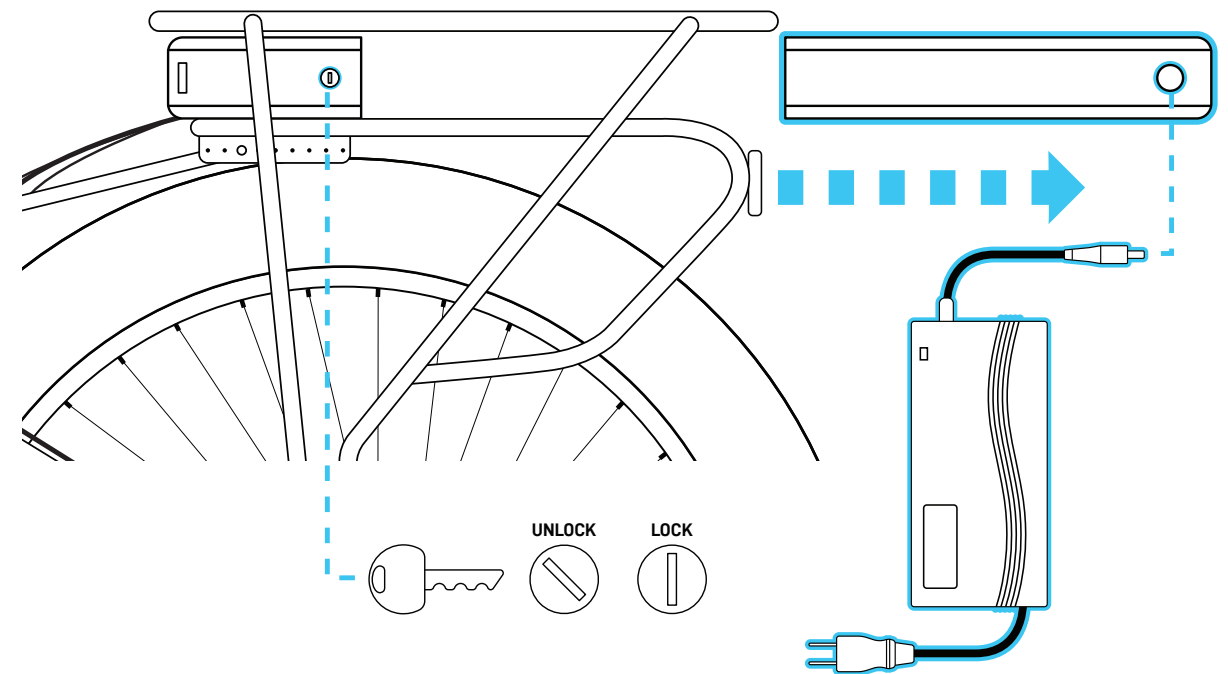

Need Help? Please click or call the team@sixthreezero.com or (310) 982-2877

TIRES

Tire Pressure PSI is written on tire sidewall.

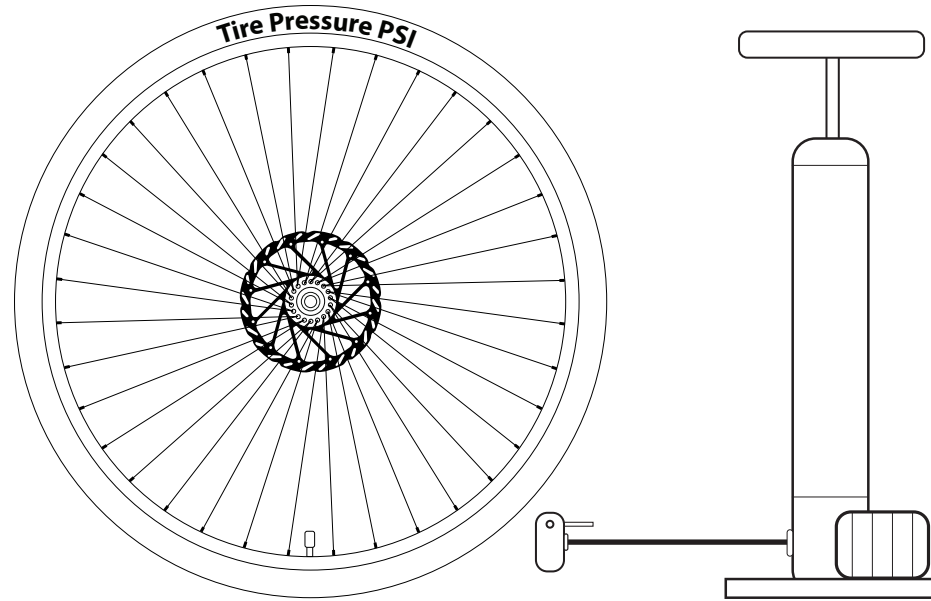

Need Help? Please click or call the team@sixthreezero.com or (310) 982-2877

TEST RIDE

Make sure your ride is smooth by testing it. If you experience any issues your bicycle may need brake or gear adjustments. Scan codes below for a quick tutorial.

Need Help? Please click or call the team@sixthreezero.com or (310) 982-2877

TUNING



BRAKE TUNING
Use camera to scan for video instructions



GEAR TUNING
Use camera to scan for video instructions



MANUAL FOR MONITOR DISPLAY
Use camera to scan for video instructions



SEAT CLAMP RE-ASSEMBLY
Use camera to scan for video instructions

CONGRATULATIONS!

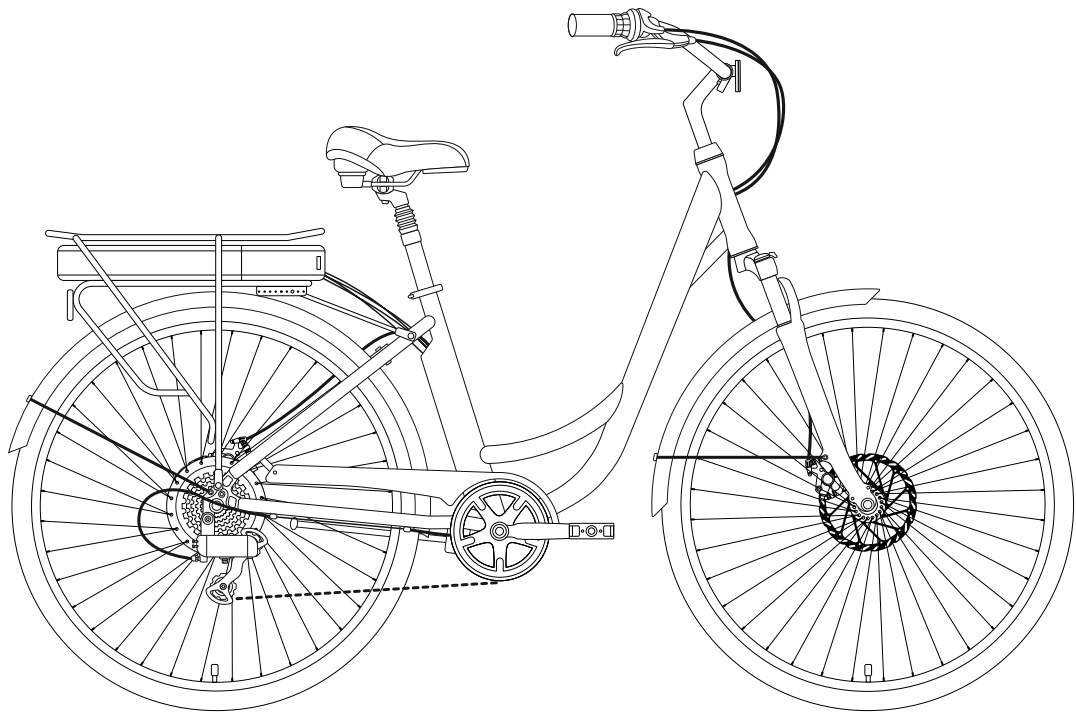

SURVEY

Tell us about your assembly experience! If you are having any trouble at all or not, and would like to leave feedback to help us improve our assembly experience, please go to our survey at:

goo.gl/6enZji

RECORD YOUR SIXTHREEZERO'S INFO

BICYCLE SERIAL # _____ DATE OF PURCHASE _____

BATTERY SERIAL # _____ DEALER'S NAME _____

MODEL _____ DEALER'S PHONE _____

COLOR _____ DEALER'S EMAIL _____

PLEASE REGISTER YOUR SIXTHREEZERO AT [SIXTHREEZERO.COM/REGISTER](https://sixthreezero.com/register)

You must register your sixthreezero within 30 days of purchase for warranty to be valid

WE STRIVE FOR PERFECT, ALTHOUGH IT'S NOT ALWAYS POSSIBLE, WE NEVER LEAVE A RIDER BEHIND.

REGISTER



Please find your serial number on the front of the head tube.

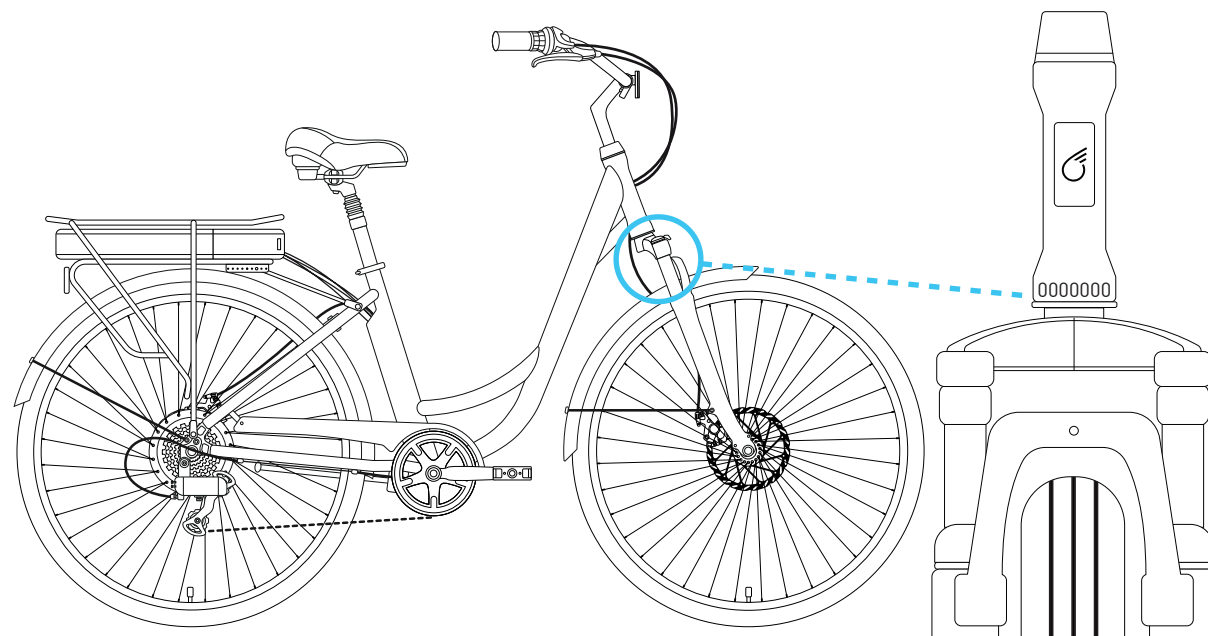

Need Help? Please click or call the team@sixthreezero.com or (310) 982-2877



SIX**THREE**ZERO
LOS ANGELES, CA

THETEAM@SIXTHREEZERO.COM
310.982.2877