

ZERO RAIN DRIPS

Sizes: 914mm (3 ft), 1219mm (4 ft), 1829mm (6 ft), 2134mm (7 ft), 3048mm (10 ft). Other sizes available to order, maximum 3048mm.

Finishes: A=mill aluminium, AA=clear anodised silver, B=sef colour brass (aka US bronze), D=dark bronze anodised and G=gold anodised where indicated.

Availability: usually ex-stock except items marked with an asterisk, which are to special order (3-5 weeks) depending on quantity.

Corrosion: Zero 8197AA and 11A rain drips have been successfully tested to Grade 4 (240 hours neutral salt spray exposure) in accordance with BS EN 1670:2007 Building Hardware - Corrosion Resistance. Report No WIL 392103 dated 30.01.2018 refers.

SERIES 8197/8 RAIN DRIP

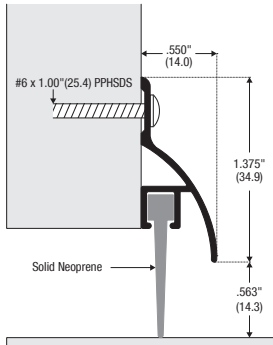

8197AA

Rain drip with neoprene. Available D & G finishes to order.

8197AA Anodised aluminium

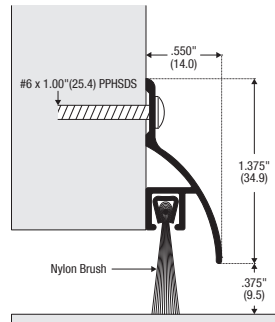

8198AA

Rain drip with brush. Available D & G finishes to order.

8198AA Anodised aluminium

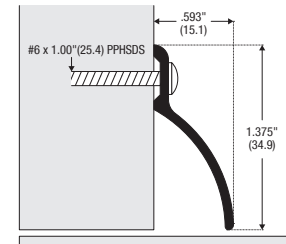

11A

Rain drip. Available D & G finishes to order.

11A Mill aluminium

SERIES 148 INTERLOCKING WATERSHED	
REF	DESCRIPTION
142A	Aluminium rain drip, mill finish, 64mm projection
141A	Aluminium watershed, mill finish, 23mm projection
141AA/EC	Aluminium end caps to suit above, anodised finish
11A	Aluminium rain drip, mill finish
11D	Aluminium rain drip, dark bronze anodised
11G	Aluminium rain drip, gold anodised

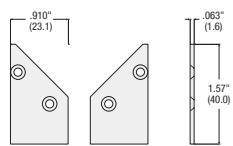

141AA/EC-STANDARD

Pair of end caps to suit 141A watershed only. Two identical plates. Aluminium, anodised finish.

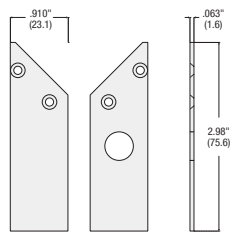

141AA/EC-EXTENDED

Pair of end caps to suit 141A watershed and auto door bottom fitted beneath it. One plate with hole for plunger side, and one plate without hole for other side. To suit 361 and 365 dropseals. Aluminium, anodised finish. (advise LH or RH)

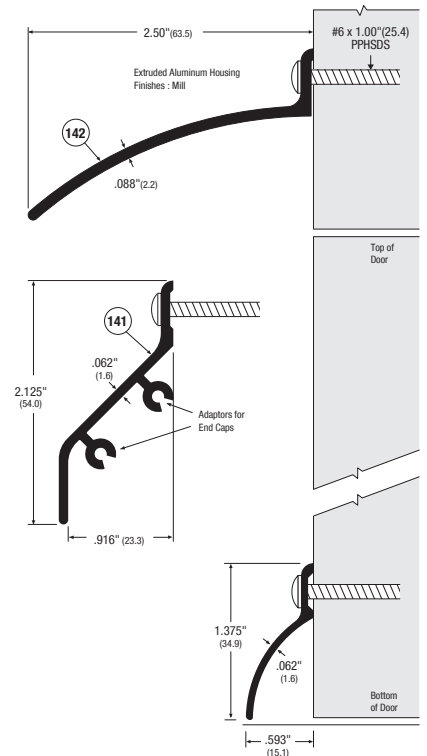

SERIES ALD MODULAR RAIN DRIP

ALD Aluminium rain drip, mill finish, five sizes of profile, 2500mm long				
REF	DIM. A	DIM. B	DIM. C	BOX QTY
ALD-A120 ▼	20mm	12mm	22mm	30
ALD-A125	25mm	12mm	24mm	20
ALD-A135	35mm	21mm	31mm	20
ALD-A150	50mm	21mm	37mm	10
ALD-A175 ▼	75mm	26mm	50mm	10

▼ To be discontinued when stocks sold.

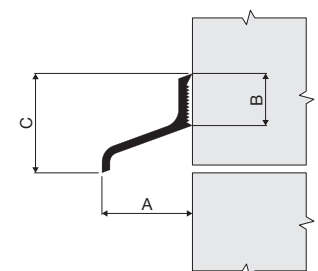

All products usually available ex-stock except those marked with *. Call for lead time. Additional manufacturers carriage charges may apply for * items. No charge for split boxes, but please try to order boxed quantity multiples where possible.