

# ELLEN FINPROTECT PLUS

FINGER PROTECTION STRIPS FOR DOORS

**ZERO**plus



IT'S ALL ABOUT FINGER SAFETY



## FINPROTECT PLUS FINGER PROTECTION STRIPS

**The professional solution to preventing painful finger injuries. Safety management is important in professional childcare. However, accidents are also just waiting to happen at schools, hospitals and homes for the elderly, and safety requires constant attention.**

In this world of litigation, schools in particular cannot afford to be left open to the charge of being negligent when it comes to ensuring the safety of a child in their care. Indeed, the incidence of children being harmed by having fingers trapped in the hinge side of the door is increasing. In the worst cases there have even been horrific incidents of children losing the ends of their fingers.

Finprotect Plus finger protection strips, manufactured by Elton BV in Holland, are anti-trapping devices that protect children's fingers at the most dangerous side of the door: the hanging side. This is the side of the door where accidents can have serious consequences for thousands of children every year.

It is so easy for little fingers to be trapped, crushed or pinched as a door closes.

Fitting Finprotect Plus at the hanging side stops children's fingers from getting trapped, preventing every parent's worst nightmare.

### All the features at a glance:

- Prevents finger trapping on push and pull sides of the door
- Suitable for use on internal or external doors
- Easily fitted and can be temporarily removed if required to adjust hinges
- Suitable for all door constructions
- Strong design with 5-year guarantee, tested to 1 million cycles
- TÜV certified
- Available in 1980mm & 2500mm lengths
- New colour - Anthracite Grey (RAL7016)



# ELLEN FINPROTECT PLUS

## PROFILE SELECTION

### AVAILABLE IN THREE PROFILES:

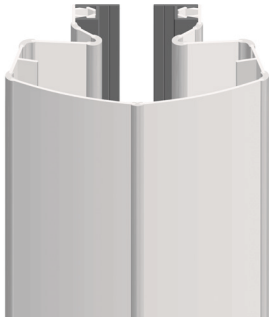

**FP90**

Standard single broad profile

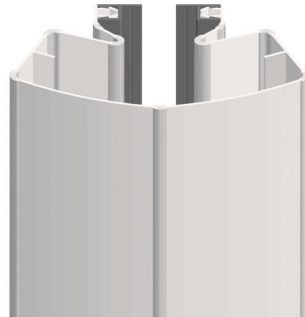

**FP120**

Extended single broad profile



**FP50**

Single narrow profile  
(for hinge knuckle side only)

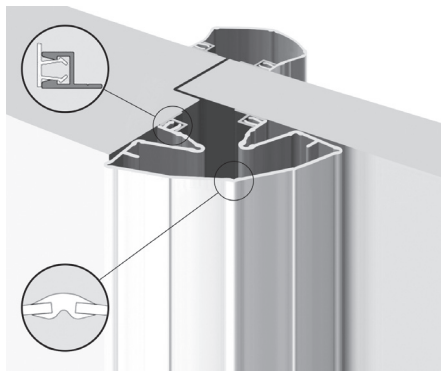

The standard set ref #FP5090 is a two-part set that fits both faces of the leaf. It comprises a narrow section for the hinge knuckle side of the leaf (pull side), and a broad section for the other side of the leaf (push side), which can be used on most single swing door types.

There is also a single swing two-part set available ref #FP90120, which incorporates the wider #FP120 broad profile. This can be used on aluminium, PVCu or steel single swing doors to give maximum opening angle.

The single broad set ref #FP90 protects only the push side of the leaf, whereas the double swing sets #FP9090 or #FP120120 protect both sides of the double swing leaf. The #FP9090 is to be used with offset pivots i.e. double action spring hinges, whereas the #FP120120 set can be used with double action floor springs. If required, it is possible to order only the narrow set ref #FP50 for the hinge knuckle side on duct doors, etc. The dual hardness synthetic section slots into aluminium strips, which have been fitted to the door and frame. This provides a totally concealed fixing.

### WHICH PROFILE TO USE?

By using the Finprotect Plus "Measuring Template" available at [www.zeroplus.co.uk/finprotect](http://www.zeroplus.co.uk/finprotect), you can easily check what type Finprotect Plus is best suited for your situation; #FP50, #FP90 or #FP120. Remember to print them off at a scale of 1:1 and then offer them up to the door and frame to establish which Finprotect profile is required for your door. For problem doors required to open to 180° we always suggest using the extra wide profile #FP120.

### SIZES

The standard length for Finprotect Plus is 1980mm, requiring no cutting if being used on standard 2040mm doors, but it can be cut to size with a junior hacksaw. However 2500mm lengths are also available to order for taller doors. The aluminium profiles that are fitted to the door and frame are 15mm wide x 10mm high and are also easily cut to suit door and frame height.

### OPENING ANGLES

Double swing aluminium doors and PVCu doors fitted with Finprotect Plus are limited to 130° in either direction. However, the maximum opening angle for hinged timber and steel doors is between 130° and 180°, depending on the type of hinge being used and the door thickness. If in doubt please refer to the measuring templates on our website which show the maximum "reach" of each profile.

### TESTING & GUARANTEE

Finprotect has been tested to one million cycles at SHR (Holland) and is guaranteed for five years, subject to correct installation and fair wear and tear. It has been tested for safety, function and durability at LGA Nürnberg (Germany) and for fire retarding M1 at CSTB (France). TÜV certified.

Successfully tested to Grade 4 (240 hours neutral salt spray exposure) in accordance with BS EN 1670:2007 Building Hardware - Corrosion Resistance. Report No. WIL 392103 dated 30.01.2018 refers.

Testing to new British Standard BS 8613:2017 is to be carried out during 2018. Please contact us for further information.

# ELLEN FINPROTECT PLUS

## EXTENDED RANGE OF PROFILES & COLOURS

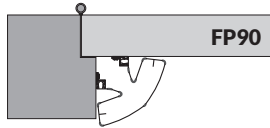

FP90

For push side only

### SINGLE BROAD SET

FP90-198  
(1980mm long)

FP90-250 \*  
(2500mm long)

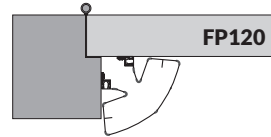

FP120

For push side only of thicker doors

### SINGLE EXTENDED SET

FP120-198  
(1980mm long)

FP120-250 \*  
(2500mm long)

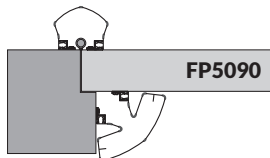

FP5090

For both faces of door

### STANDARD TWO-PART SET

FP5090-198  
(1980mm long)

FP5090-250 \*  
(2500mm long)

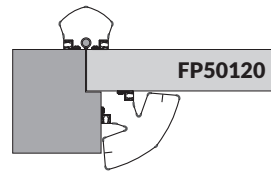

FP50120

For both faces of thicker doors

### EXTENDED TWO-PART SET

FP50120-198  
(1980mm long)

FP50120-250 \*  
(2500mm long)

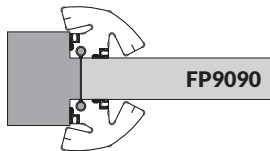

FP9090

For double action spring hinges

### DOUBLE BROAD SET

FP9090-198  
(1980mm long)

FP9090-250 \*  
(2500mm long)

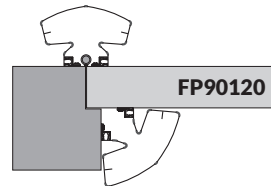

FP90120

For both faces of thicker doors

### EXTENDED TWO-PART SET

FP90120-198  
(1980mm long)

FP90120-250 \*  
(2500mm long)

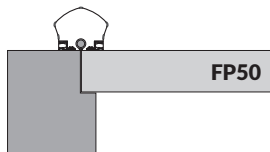

FP50

For pull side only

### SINGLE NARROW SET

FP50-198  
(1980mm long)

FP50-250 \*  
(2500mm long)

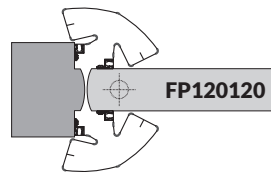

FP120120

For double action floor springs

### DOUBLE EXTENDED SET

FP120120-198  
(1980mm long)

FP120120-250 \*  
(2500mm long)

\* 2500mm lengths not available blue, red or yellow



### Available in a wide range of colours:

Finprotect Plus is available in white and black, as well as six other colours: brown, light grey, dark grey (anthracite), blue, red and yellow to co-ordinate with building colour schemes and door hardware. Please note that all RAL codes are indicative.



White  
RAL 9010



Black  
RAL 9005



Brown  
RAL 8014

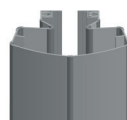

Grey  
RAL 9006



**NEW**  
Anthracite  
RAL 7016

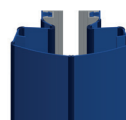

Blue  
RAL 5013

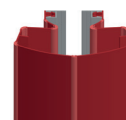

Red  
RAL 3002

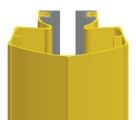

Yellow  
RAL 1021

# ELLEN FINPROTECT PLUS

## INSTALLATION & ACCESSORIES

### INSTALLATION

Finprotect Plus fits simply on to all types of doors. Despite this, we recommend checking your door details with the fitting instructions before you start fitting. Torx screws are included with every set to assist assembly, as well as fixing instructions. The simple "fin" design speeds up installation.

Simply fit the aluminium profiles to the door and the frame and then click the synthetic profiles into the aluminium channels. Finprotect Plus can be trimmed to length using a junior hacksaw, although care should be taken not to snag the "hinge" when cutting.

In most instances we recommend the use of doorstops to limit the opening angle and to avoid damaging the Finprotect Plus.

To fit Finprotect Plus you will require competent handyman skills and the following tools: a tape measure, a pencil, a hammer, a Torx T10 driver bit, a hacksaw with 24 TPI minimum and a power driver.

Self-tapping screws are also available for fitting to aluminium or steel doors, or self-adhesive tape for fitting to metal or PVCu doors, to aid installation

Full fixing instructions are supplied with every set as standard, however if further assistance is required there is an installation video available to view at [www.zeroplus.co.uk/finprotect](http://www.zeroplus.co.uk/finprotect).



#### ZF9 LINKING CHANNEL FOR FINPROTECT PLUS

There will always be doors with an extreme opening gap, which the standard Finprotect Plus strips cannot cover. This may be as a result of particularly thick doors or of doors being hung on projecting hinges. In order to deal with this problem, Ellen has developed a special linking piece. The new Linking Channel for Finprotect Plus is an aluminium linking piece which links two standard Finprotect Plus strips together creating a broader Finprotect Plus strip which is able to cover extreme gaps.

The Finprotect Plus Linking Channel is not only easy to install, but is also removable in order to adjust or lubricate the door hinges. Additionally, this Linking Channel is invisible, fitting on the inside of the Finprotect Plus strips, which prevents children from removing the Linking Channel from the strips. Furthermore, the two pieces of Finprotect Plus look smart, resembling just one large strip despite actually being in two halves.

It is compatible with all three Finprotect Plus profiles; #FP50, #FP90 and #FP120. No fixings are required and it simply slides into place between the two Finprotect Plus profiles. The standard length is 2500mm but it may be cut down to 1980mm on site so that it suits either length of Finprotect Plus.



#### ZF10 SELF-TAPPING SCREW PACK FOR METAL DOORS

Finprotect Plus is supplied with zinc plated Torx head wood screws as standard, which are suitable for fixing the mounting strips to timber doors. However, if the product is being fitted to metal doors we can supply Pozi head self-tapping screws. These are supplied in packs of 35.



#### ZF11 SPARE SCREW PACK FOR TIMBER DOORS

Finprotect Plus is supplied with zinc plated Torx head security screws as standard which are suitable for fixing the mounting strips to timber doors. These are available as spares and are supplied in packs of 24.

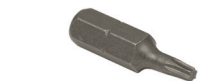

#### ZF15 DRIVER BITS FOR TORX SCREWS **NEW**

Torx T10 driver bit for fitting Finprotect Plus, 25mm long.

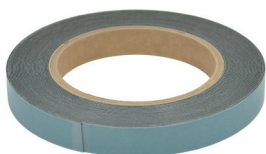

#### ZF12 SELF-ADHESIVE TAPE PACK FOR PVCu DOORS

If Finprotect Plus is being fitted to PVCu, composite or glass doors then customers may decide to use double-sided self-adhesive tape rather than screws to fit the aluminium channels to the door and frame. Please note self-adhesive tape should only be used internally. 10 metre roll.



#### ZF13 MOUNTED SAMPLE BLOCK

For trade counter use and customer presentations we are able to offer a mounted sample block. This shows #FP5090 white mounted on a small hinged door, which demonstrates the true operation of Finprotect Plus. Other loose samples in different colours are available upon request.



# ZEROplus

Zero Seal Systems Ltd

Units 43-45 Ladford Covert, Seighford,  
Stafford ST18 9QG United Kingdom

Tel: +44 (0)1785 282910

Fax: +44 (0)1785 282498

E-mail: sales@zeroplus.co.uk



Raising Standards  
Safety Assured



advancing  
architectural  
ironmongery



Cert No. 51091