

# INFINITY<sup>®</sup>

## MASSAGE CHAIR



# INFINITY<sup>®</sup>

72 Start Road, Seabrook, NH 03874  
603-910-5000  
[www.infinitymassagechairs.com](http://www.infinitymassagechairs.com)

User Manual

IT-8500 X3

## ▶ TECHNICAL SPECIFICATIONS

---

Name: Infinity Deluxe Massage Chair

Model: IT-8500-X3

Rated voltage: 110V~

Rated frequency: 60 Hz

Rated power: 240W

Safety design: Class I

Thank you for your purchase of this product. Before using, please read this USER MANUAL carefully, and pay special attention to the safety precaution to ensure proper operation and use.

Please keep this USER MANUAL properly for further reference.

## ▶ CONTENTS





---

SAFETY PRECAUTIONS .....	1
NAME AND FUNCTION OF EACH COMPONENT .....	3
External structure .....	3
Internal structure .....	3
Power box .....	4
Controller .....	5
Instruction of Controller .....	6
FUNCTIONS AND FRATURES .....	13
APP DOWNLOAD AND INSTALLATION .....	14
PRECAUTION BEFORE USING .....	16
Installation position .....	16
Floor protection .....	16
Surrounding environment .....	17
Grounding .....	17
Installation method .....	18
Move method .....	23
Turn on power supply .....	23
Massage chair commissioning .....	24
Before sitting in the chair .....	24
PRODUCT STORAGE AND MAINTENANCE .....	25
TROUBLE SHOOTING .....	26
TECHNICAL SPECIFICATION .....	27



## ▶ SAFETY PRECAUTIONS

### Safety Precautions

- ▶ Before using, please read this “SAFETY PRECAUTIONS” carefully to ensure proper operation.
- ▶ The following “SAFETY PRECAUTIONS” is of great help to your correctly use of this massage chair.
- ▶ To clearly indicate the degrees of danger and damage, the classes of accidents caused by incorrect use are classified into “WARNING” and “CAUTION”, instructions marked as followings should be strictly followed:

	<b>WARNING</b>	Improper operation may cause injury to users.
	<b>CAUTION</b>	Improper operation may cause users injury or product damage.
	Forbidden. Specific instruction will be indicated in the diagram drawings.(E.g, the left drawings means disassembly is not allowed.)	
	Compulsory Specific instruction will be indicated in the diagram drawings.(e.g, the left drawings means to disconnect the power plug)	

### WARNING

	<b>COMPULSARY</b>	<p>We recommend that those with any of the following conditions should consult a doctor before using.</p> <ol style="list-style-type: none"> <li>1. Those who are using electronic medical instrument imbedded in the body, such as cardiac pacemaker etc.</li> <li>2. Those that are being treated by doctors, especially those who feel uncomfortable.</li> <li>3. Those who are malignant tumor patients, heart disease patients, acute patients.</li> <li>4. Women who are pregnant or menstruating.</li> <li>5. Those with osteoporosis or fracture spine.</li> <li>6. Those with skin disease or those whose skins are injured.</li> <li>7. Those whose body temperature is over 38 degrees (Febrile Phase).</li> </ol>
	<b>PROHIBITED</b>	Do not allow the mentally disabled to use the chair alone. (It is OK under supervision)
		Do not allow children play on massage chair.
		Do not allow more than one person to use this massage chair at a time.
		If the power cord or power plug becomes damaged in any way you must disconnect from the mains supply immediately and consult an authorized service engineer for repair or replacement.
		Do not damage, process, excessively bend, pull hard, twist or knot power cord.
	<b>NO DISASSEMBLY</b>	Juveniles are not allowed to use this product.
		Anyone else, except maintenance personnel specified by our company, should not disassemble, maintain, or remodel this massage chair. If any problem, please contact local dealer immediately.

## ▶ TROUBLE SHOOTING

No.	Problem	Possible Cause	Solution
1	The sound “Xu Xu”, “Ta Ta” is heard.	It is a normal sound made by the working motor or the sound is produced when the massage ball is rubbed against the cloth cover.	It is normal and no need for treatment.
2	The machine can not be started up.	The power supply plug is detached.	Insert the power supply plug into the socket again.
		The power supply switch is not turned on.	Turn on the switch
3	The airbag installed at seat cushion or legrest can not work.	The fuse of massage chair blew out.	Replace a new one with the same mode
		To check whether there is air tube blockage.	To clear the air tube

If abnormal phenomenon still remains after above measures have been taken to the massage chair, please contact local distributor for repair and maintenance.

**Note:** Do not dismantle the product by yourself, and our company shall shoulder no responsibility to the damage of the product or the injury of people caused by improper use! Thanks your cooperation.

## ▶ PRODUCT STORAGE AND MAINTENANCE

### Maintenance

- ▶ Please twist the cotton cloth which has been dipped in neutral detergent before wiping the back cover, hand rest, legrest, air tube and some other plastic components, then use a dry cotton cloth to wipe them again.
- ▶ Use dry cloth to wipe the controller, DVD, and power supply box.
- ▶ Use a piece of cloth that has been dipped with neutral detergent to wipe the back cushion and pillow, then use a piece of wet cloth to wipe them, and finally put them to a well-ventilated place for natural drying.

#### Caution

- ▶ Make sure to pull out the power supply plug firstly before maintenance. Do not use wet hands to pull out the plug to avoid electric shock. When clean the back cover, please be cautious of detergent entering into the power supply box!
- ▶ Do not iron the upholstery.

### Storage method

- ▶ Wipe off dust and dirt from the product after use, if the product is not to be used for a long period of time, please cover the product with a dust cover (self provided).

#### Caution

- ▶ Do not store the product under direct sunlight or in places of high temperature. This may cause the color of the upholstery to fade.

### Kind reminding

During daily use, please check whether the following symptoms exist:



- ▶ Scorched smell exists.
- ▶ When touch the wire, the power is on, but sometimes off.
- ▶ The power supply cord is hot.
- ▶ Other abnormal symptom

#### Caution

- ▶ Please stop using the massage chair to avoid breakdowns and accidents occurring if any above symptom exists.
- ▶ Turn off the power supply switch and pull out the power supply plug, and then contact the local distributors or headquarters for repair and maintenance.
- ▶ Except all the normal operation and maintenance mentioned above, any other repair and maintenance can only be operated by our authorized dealer or service agent.

## ▶ SAFETY PRECAUTIONS

### CAUTION

 COMPULSARY	<ul style="list-style-type: none"> <li>◆ Please do not continuously use the massage chair over 20 minutes, and it is limited to massage a particular part of body in 5 minutes.</li> <li>◆ Please put the massage chair on flat ground for use.</li> <li>◆ When adjusting the legrest or backrest, please do not exert excessive force on it; in addition, keep children and pets well clear.</li> <li>◆ When removing power plug, please hold the insulation plug, do not pull power cord.</li> <li>◆ Please do not use the power supply that is beyond the specified electric voltage, as this may cause fire disaster or damage massage chair.</li> <li>◆ Before using, please uncover the back cushion to check whether backrest or fabric is damaged; if damaged, please stop using this massage chair immediately, and contact franchiser for repair immediately.</li> <li>◆ Please do not operate the controller with damp hands, and do not put heavy objects on controller.</li> <li>◆ Only people less than 120kgs are acceptable.</li> <li>◆ Please do not use other therapeutic equipments together with this massage chair.</li> <li>◆ During use, if you feel uncomfortable, please stop use immediately and consult your doctor.</li> <li>◆ This massage chair is designed and intended for non commercial household use only, do not use the massage chair for medical treatment.</li> <li>◆ The massage chair is equipped with heating function, so people who are insensitive to heat must use it carefully.</li> <li>◆ Always switch off power and remove the plug from the mains socket immediately after use and before cleaning.</li> </ul>
 PROHIBITED	<ul style="list-style-type: none"> <li>◆ To avoid causing discomfort, do not use the massage chair immediately after meals.</li> <li>◆ Do not fall into sleep on massage chair, when the massage chair is working.</li> <li>◆ Do not use the massage chair when you are drunk or feel bad.</li> <li>◆ If the upholstery becomes dirty, please use only known good quality leather cleaner, do not use chemical cleaners, petrol or detergents etc, and do not spray pesticide on it.</li> <li>◆ Do not sit on backrest, legrest, or armrest to avoid accidental injury or machine fault.</li> <li>◆ Please do not smoke while using the massage chair.</li> </ul>
 REMOVE PLUG	<ul style="list-style-type: none"> <li>◆ Before maintenance, please pull out power plug. In addition, please do not insert or unplug the power plug with damp hands, to avoid electric shock.</li> <li>◆ When the massage chair is not in use, please switch off power and remove the plug from socket. When power is off, please cut off power supply immediately and pull out the power plug from socket.</li> </ul>



## ▶ NAME AND FUNCTION OF EACH COMPONENT

### External structure

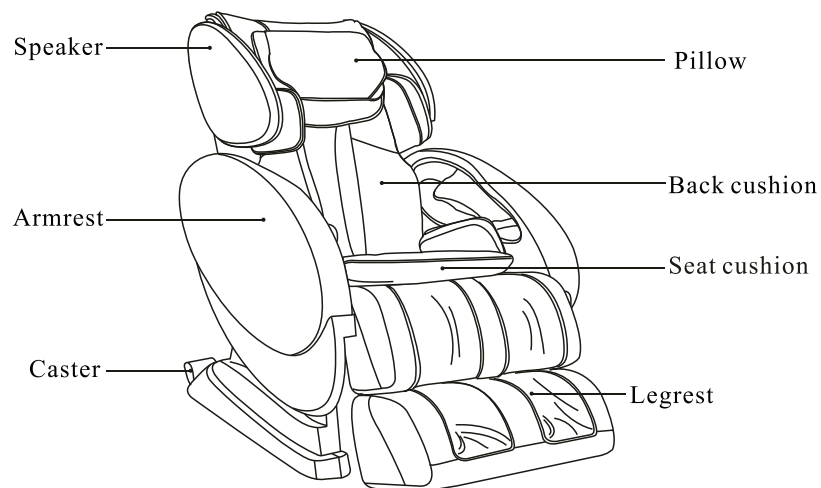

### Internal structure

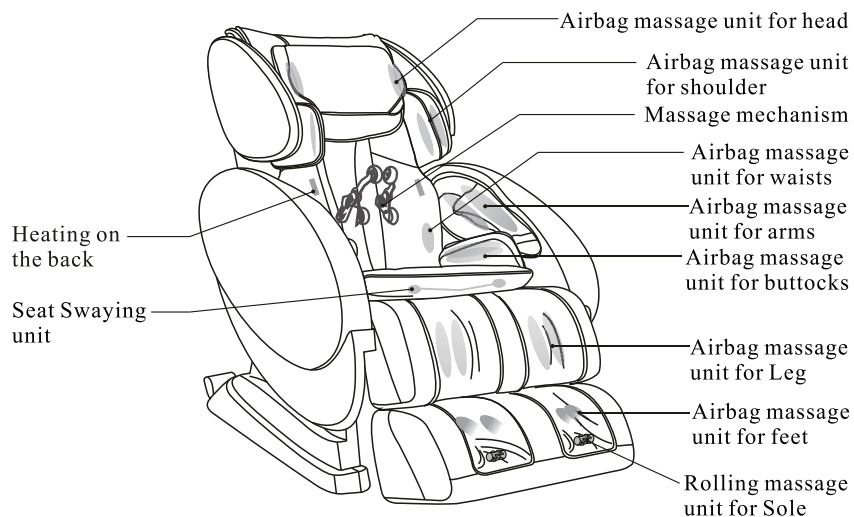

## ▶ PREPARATION BEFORE USING

### Massage chair commissioning

- ▶ Before commissioning, please make sure there is enough space around the chair. Then use the controller to recline down the chair backrest to the limit position, rise up the legrest to the highest position and stretch out to the limit length.
- ▶ Testing all functions work normally, then power off the chair, return back to original position.  
(How to select the program, please refer to “ Controller instruction” and “display screen menu instruction” )

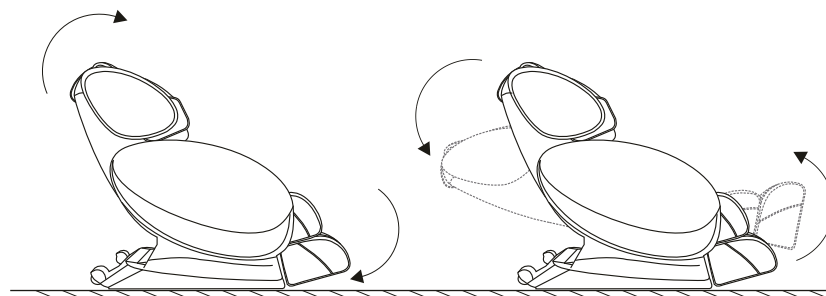

### ⚠ Caution

- ▶ Do not put fingers or any other objects into the gap between the seat and legrest.
- ▶ When adjusting up and down angles of the backrest and legrest, please make sure there is no obstacle around the massage chair.
- ▶ During using, please make sure the power cord is not enlaced or clamped but laid orderly.

### Before sitting in the chair

- ▶ Make sure the legrest is well installed.
- ▶ Make sure the chair is in original position, if any part is not in initial position, please power on/off again to make the whole chair go back to original position.

### ⚠ Caution

- ▶ If the legrest rises up, please do not seat on the chair.
- ▶ Do not make the legrest to suffer from heavy loading suddenly, or it may damage the legrest mechanism.

## ► PREPARATION BEFORE USING

### Move method

- ▶ There are moving rollers at the bottom of the chair.
- ▶ Raise the back to the highest point.
- ▶ Switch off and plug out the chair.
- ▶ Lift the front part of the chair as showed in the figure(one person raise the front part via holding moving holder, another person push the chair when holding the top of the chair) , move the chair by the rollers.

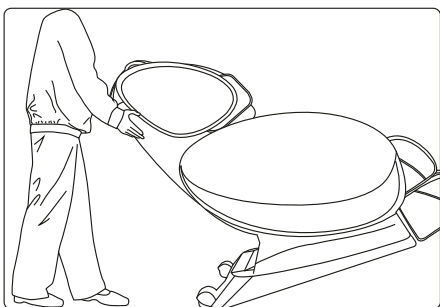

### ⚠ Caution

- ▶ Don't move it when there is people in it.
- ▶ Don't use the armrest while moving the chair, only hold the moving holder in the back and front

### Turn on power supply

- ▶ Plug the power cord into three core socket with well grounding.
- ▶ Tun on the power switch on the bottom of massage chair.

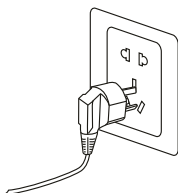

### ⚠ Caution

- ▶ Before switching on the chair, please make sure there is no damage on the power wire and other exposed wires.
- ▶ Make sure the power switch is off before the chair is connected to electricity.

## ► NAME AND FUNCTION OF EACH COMPONENT

### Power box

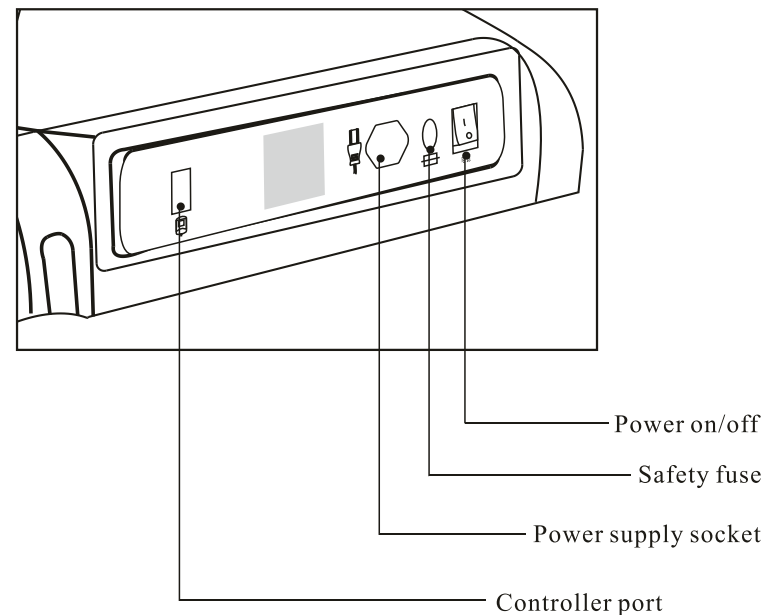

### ⚠ Caution

- ▶ Do not let children play on the chair in case that accident happens due to the power supply box.
- ▶ Please power off the chair and unplug the chair from the power supply socket after the massage finishes
- ▶ Do not use the chair under thunders in rainy days.
- ▶ Please power off the chair and unplug the chair from the power supply socket when the chair is not in use, so that children won't accidentally get the chair started.
- ▶ Please store the chair if it is not in use for a long time.

## ▶ NAME AND FUNCTION OF EACH COMPONENT

### Controller

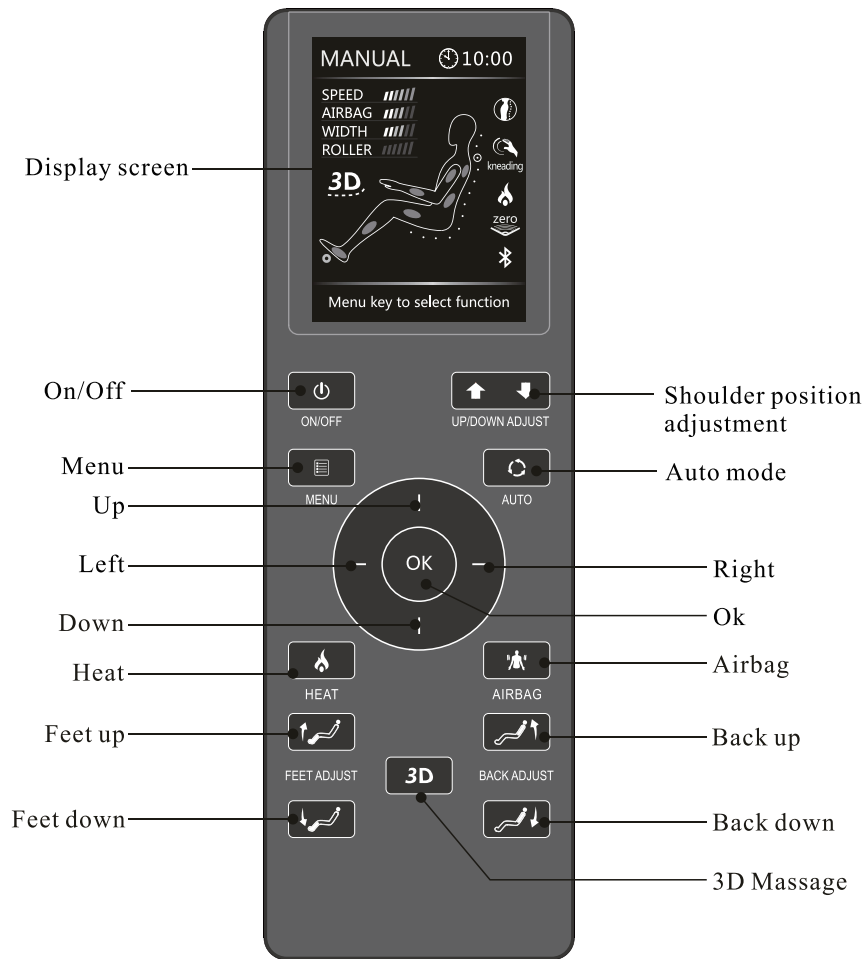

## ▶ PREPARATION BEFORE USING

### Step 6 Other accessories

- ▶ Connect the controller, wire to respective jack on the power supply box.
- ▶ Connect the power and switch on the chair, use the controller to return the back rest to normal position.

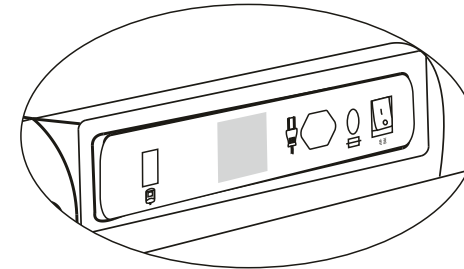

## ▶ PREPARATION BEFORE USING

Step 4: Installation of the shoulder massager and speaker.

- ▶ Connect the wire from upper side of backrest with the wire from the speaker.
- ▶ Insert the three joint pins in shoulder massager and speaker to the three connecting tubes in backrest.(after inserted well, please move down the slider to expose the locking screw), fasten them by locking screws, and move back the slider. (It is the same installation method for the other side)

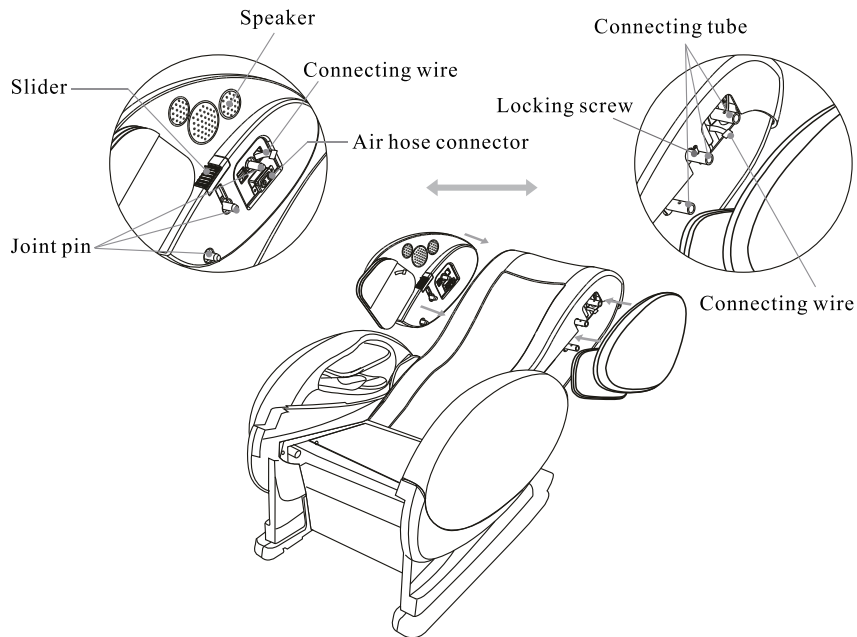





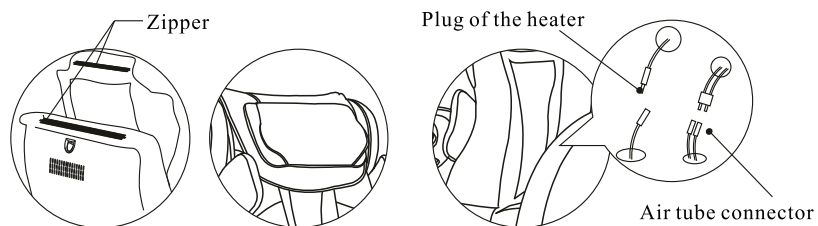



Step 5 Installation of back cushion and buffering cushion

- ▶ Fix the buffering cushion and back cushion on the backrest with zipper, and install the heater accessory on the back cushion, connect the connector of pillow and waist' s air tube as the illustration shows. Connect the lower part of the cushion with seat cushion by linking tape.







## ▶ NAME AND FUNCTION OF EACH COMPONENT

### Instruction of Controller

-  **On/Off**
  - ▶ When power is on, click this button, display screen is lightening, then click up/down button to choose the auto mode, manual mode, , 3D massage,sway,air pressure massage, heat and set menu.
  - ▶ Click this button again to turn off all functions. The default working time is 20 minutes
-  **Menu**
  - ▶ Click this button to choose auto mode, manual mode, air pressure massage, sway, heat, 3D massage, and set menu.
-  **Shoulder position adjustment**
  - ▶ Under manual and point mode, press UP/DOWN to adjust the position of point massage.
-  **Auto programs**
  - ▶ When massage chair is working, press auto button to enter auto program menu, you can choose sports refresh, extention, rest& sleep, working relief, neck&shoulder or waist&spine according to your own body state and massage time.(3D massage excluded). (See the LCD menu for detail)
-  **Direction adjustment**
  - ▶ Under menu and auto mode, press the button to adjust direction. When program is determined, press the middle OK button to confirm it and enjoy the chosen massage.
  - ▶ During the massage, press OK button to switch over zero gravity, Press up or down button to adjust mechanism speed. Press left or right button to adjust airbag force.
-  **3D massage**
  - ▶ Under manual mode, press 3D button to adjust the 3D force.
-  **Heating**
  - ▶ Press this button to start the heating function,the indicating in the screen will be lightening;Press this button again,heating function will be shut off,the indicator in the screen will be off.
-  **Airbag**
  - ▶ Press this button to enter the adjusting program for air pressure massage,press up and down button to adjust massage part and air pressure strength.

## NAME AND FUNCTION OF EACH COMPONENT

- 
**Feet up**  
 ▶ Press this button, the legrest will be moved up to the top position, release this button, it will stop.
- 
**Feet down**  
 ▶ Press this button, the legrest will move down to the lowest position, release this button, it will stop.
- 
**Back up**  
 ▶ Press this button, the backrest will be moved up to the original position, release this button, it will stop.
- 
**Back down**  
 ▶ Press this button, the Backrest will be moved down to the lowest position, release this button, it will stop.

## Instruction of Display screen menu

### ▶ Auto mode

When electricity is connected, press power button, LCD is on. Press auto to enter auto program menu, you can choose sports refresh, extension, rest& sleep, working relief, neck&shoulder or waist&spine according to your own body state and massage time. (See the menu picture below )

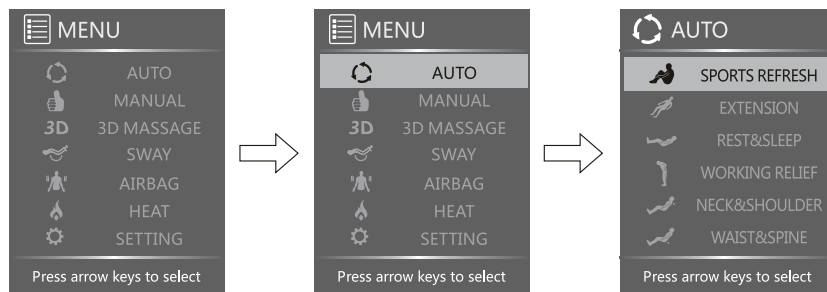

**Sports refresh:** This is designed for the muscles after sports activities and exercise. It can ease and relax muscles after intense exercise, especially promote the body circulation system to improve the muscle recovery after exercise.

**Extention:** This massage comes from Thai massage. the strong kneading and stretch of the body can effectively stretch legs, waist and other parts, and it is the best choice to relax tired muscles and increase physical vigor.

**Rest and sleep:** To improve the quality of lunch break and sleep; The mild massage kneads body parts from heavy strength to light one, from light to no strength to relieve tired body gradually.

**Working relief:** This is an exclusive program for white collars, who work long time at desk and often make business trip, it can ease muscles and recuperate body.

**Neck and Shoulder:** To relieve neck and shoulder pain symptom. 80% of the massage time will focus on the neck and shoulder. The curve design of the chair backrest makes the massage rollers completely touch the shoulder and neck. So it can effectively relieve your fatigue of these parts.

## PREPARATION BEFORE USING

### Step 3 Installation of leg massage shelf

- ▶ Insert the leg connection wire plug to its jack.
- ▶ Connect air tube from the leg massage shelf with its port on the seat shelf.
- ▶ Aim the coupling shaft port on the leg massage shelf to the coupling shaft on the seat and fasten them with one screw each side.
- ▶ Paste the folding PU cover on the leg massage shelf with linking tape on the cloth of the seat.

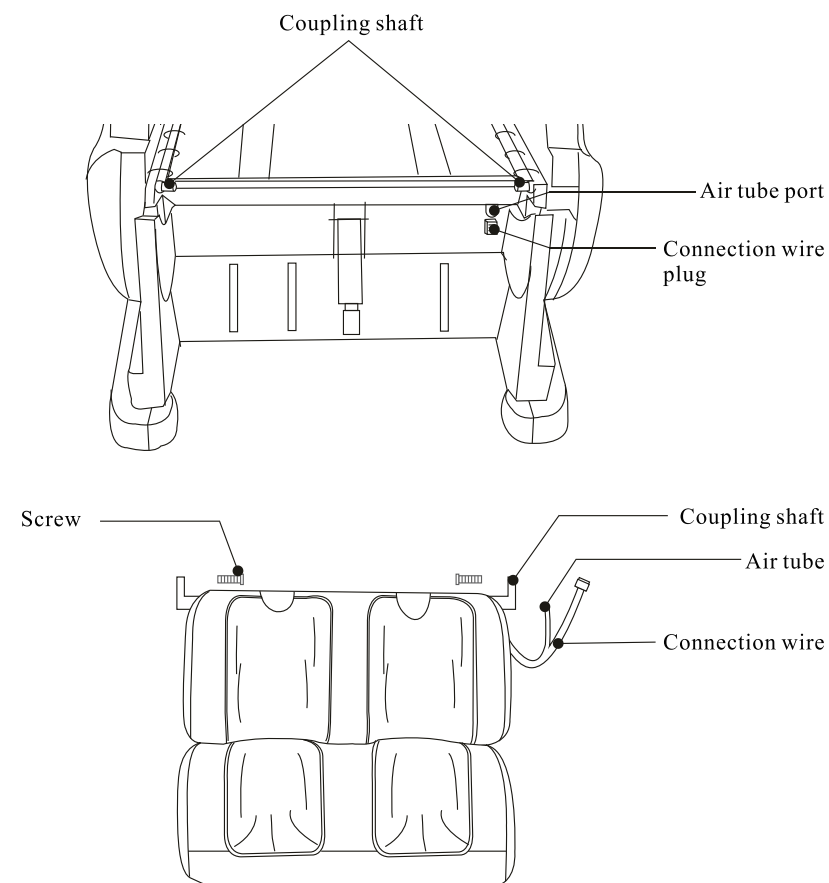

## PREPARATION BEFORE USING

- ▶ Make sure the 4 connection sticks completely inserted into the eccentric joints, then use cross screwdriver to fasten the armrest by turning 180° clockwise. (The sharp point on the eccentric joint shall point downward “⊕”) It is the same installation method for the other armrest.

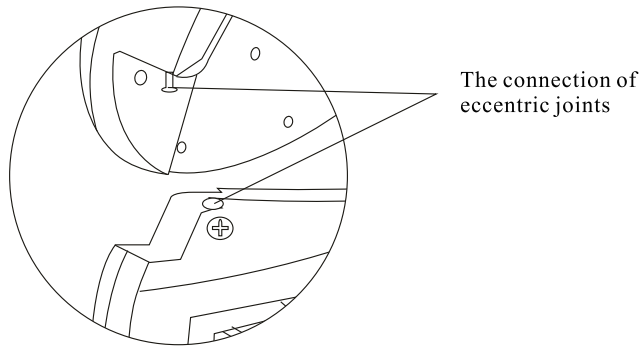

- ▶ The connection of armrest locks with backrest. Hold up the rear part of the armrest, push inward to let the gap of armrest lock aim at armrest spindle, then push the armrest to fasten them together. (Press downward the handle of the lock to unlock armrest and backrest)

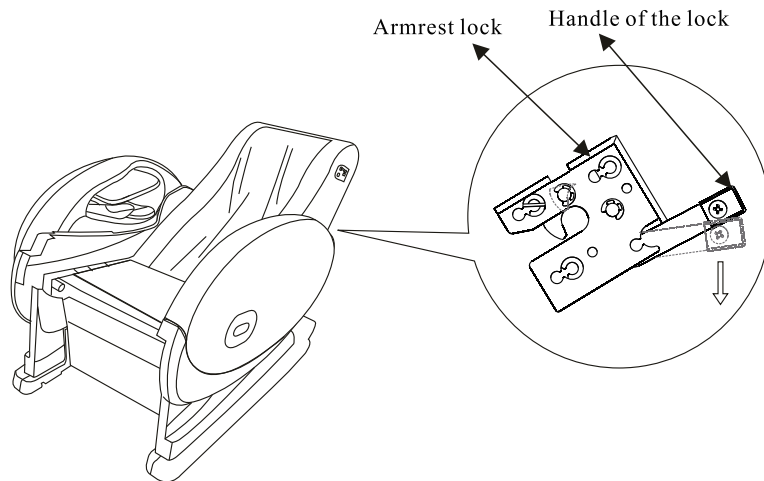

## NAME AND FUNCTION OF EACH COMPONENT

**Waist and Spine:** To relieve the pain of lumbar vertebra. 80% of the massage time will focus on the lumbar vertebra and the rollers will conduct specific massage to relieve the sense of tension and keep the health of this part.

### ▶ Manual Programs:

Press Menu button, choose Manual and press it to enter manual programs. Press up or down button to choose mode, part, width, speed, roller or zero.

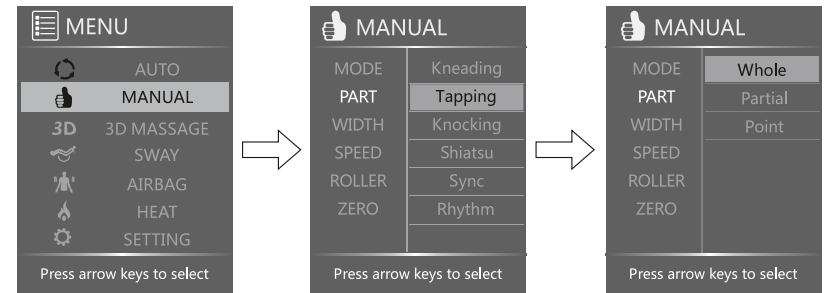

**Mode:** Under mode function, press right button first, then press up or down button to circulation choose massage manipulation of kneading, tapping, knocking, shiatsu, sync, or rhythm.

**Part:** Under Part function, press right button first, then press up or down button to circulation choose whole, partial or point. Back massage mechanism is by whole, partial and point.

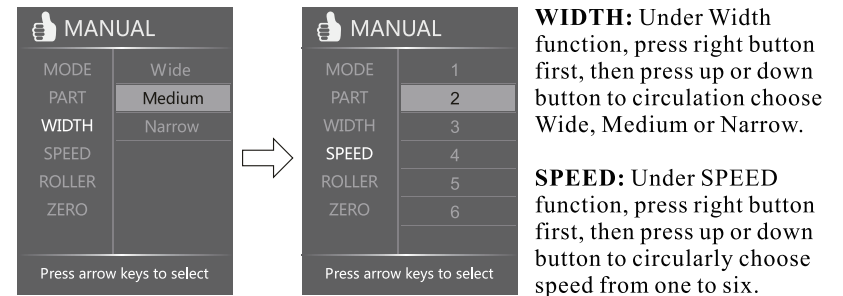

**WIDTH:** Under Width function, press right button first, then press up or down button to circulation choose Wide, Medium or Narrow.

**SPEED:** Under SPEED function, press right button first, then press up or down button to circularly choose speed from one to six.

**ROLLERS:** Press MENU button first, then choose ROLLER, adjust the roller speed from 1 to 3 or stop the rollers by pressing up or down button.

**ZERO GRAVITY:** Zero gravity creates a completely relaxing, naturally comfortable massage position: Somatological design makes back, buttocks and leg stay in a certain angle like lying in space capsule, under which the body pressure is thoroughly released and the muscle come into completely relaxing status.

## ▶ NAME AND FUNCTION OF EACH COMPONENT

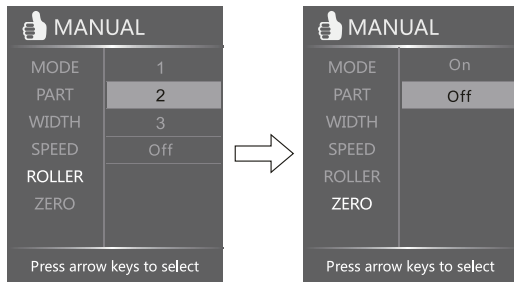

### ▶ 3D MESSAGE:

Press MENU button first, then choose 3D, adjust the 3D MODE (Deep shiatsu, healthy breath, massage extend), massage force and part.

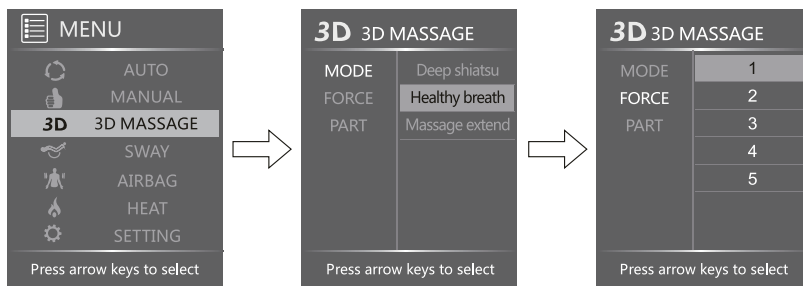

**Deep shiatsu:** deep shiatsu on the back for 10 minutes;  
**Healthy breath:** 5 minutes breath health works along with chair mechanism's rhythm for breathing in and out, which does good to the user's health.  
**Massage extend:** 5 minutes massage extend.  
**FORCE:** Under manual, 3D massage force is adjustable from 1 to 5 grades.  
**Part:** Under Part function, press right button first, then press up or down button to circulation choose whole, partial or point massage.



## ▶ PREPARATION BEFORE USING

### Installation method

Step 1: Take out the components of massage chair

- ▶ Open the main carton, and take out the quilting product packages, accessory carton and the main body of the massage chair carefully.
- ▶ Check whether the components are complete (please check one by one according to the packing list)

Step 2: Install left and right armrests

- ▶ Connect air tube port under the armrest to its corresponding output air tube. (It is the same way for the other side)

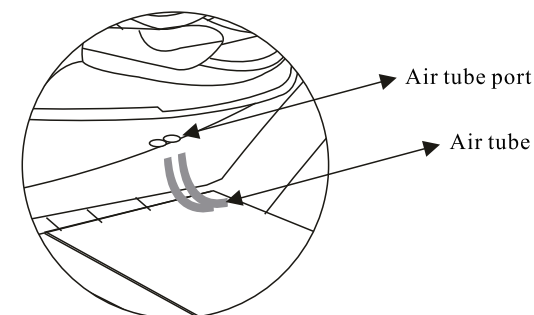

- ▶ The connection of armrest and armrest shelf: Aim the three connection sticks of armrest to the three eccentric joints on the armrest shelf, then press downwards on the armrest and fasten it by the eccentric joint. (If the rear screws are hidden by back cover, so they can't be fastened, please power on the chair to raise the back). It is the same installation method for the other armrest.

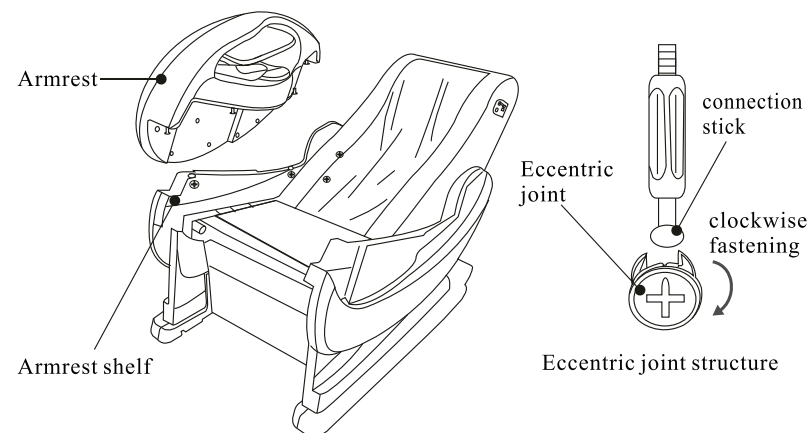







## ▶ NAME AND FUNCTION OF EACH COMPONENT

▶ **SETTING:** Press MENU button, choose SETTING, then press up or down button to set time, language or bluetooth.

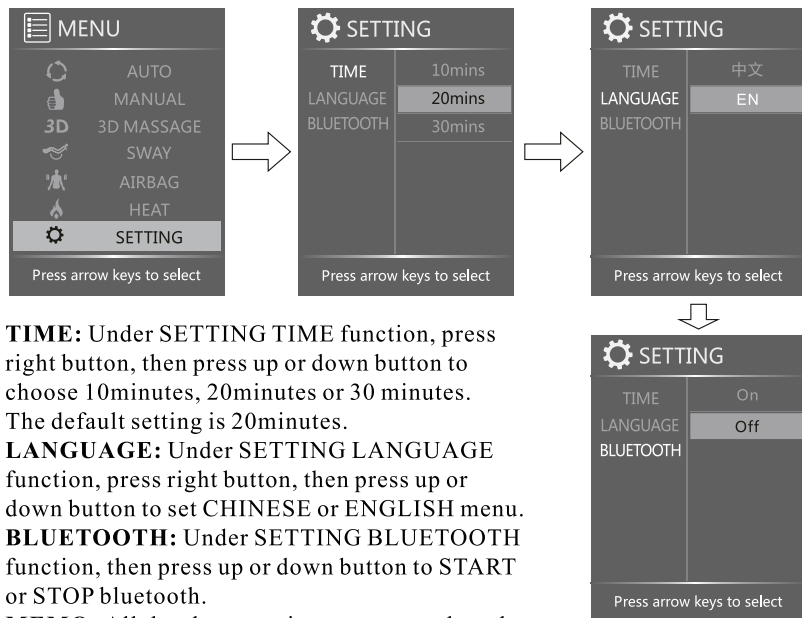

**TIME:** Under SETTING TIME function, press right button, then press up or down button to choose 10minutes, 20minutes or 30 minutes. The default setting is 20minutes.

**LANGUAGE:** Under SETTING LANGUAGE function, press right button, then press up or down button to set CHINESE or ENGLISH menu.

**BLUETOOTH:** Under SETTING BLUETOOTH function, then press up or down button to START or STOP bluetooth.

**MEMO:** All the above settings are remembered even when the machine is cut off suddenly.

## ▶ PREPARATION BEFORE USING

### Installation position

Safety distance for the periphery of massage chair.

- ▶ Please make sure there is adequate space for installation this product:
  - Back: minimum 50cm from the wall or any other blocks;
  - Front: minimum 40cm from any blocks;
- ▶ In order to prevent from signal interference, please keep at least 1m away from the TV, radio and other video and audio devices.

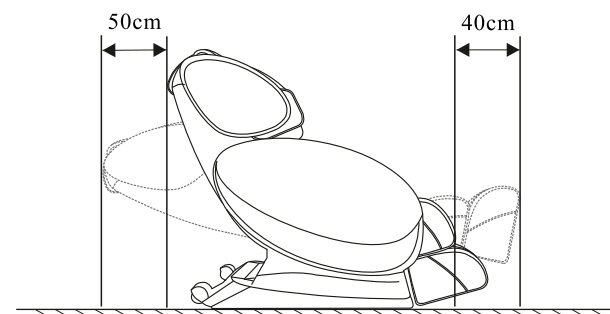

### Floor protection

- ▶ Please put carpet or other pad under the massage chair, in order to avoid any unpredictable impression on the floor.

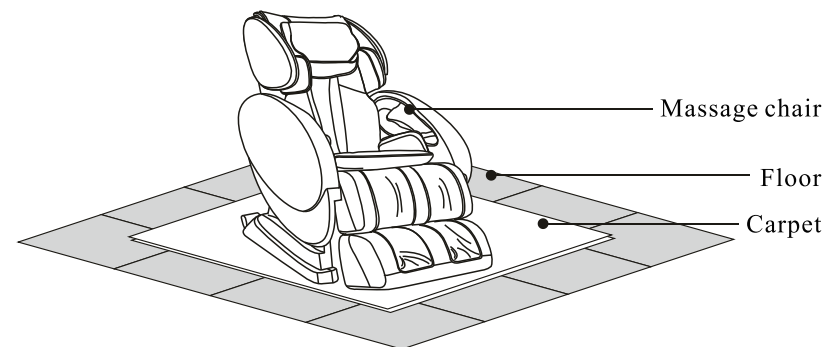

## ▶ APK GET AND INSTALLATION

### Android System

#### Software

- ▶ Please ask for software from seller, then install on the computer or mobile. (Refer below pics.)
- ▶ Install well IT-8500-X3 touch screen operation software, press setting button of the computer or mobile, press wireless and web set→blue tooth→scan blue tooth device→ IT-8500-X3, then match well. When displaying “matching well audio device” , find out IT-8500-X3, start the program. Then press setting menu→blue tooth connecting→matched well device→IT-8500-X3 for operating the massage chair.

#### ⚠ Caution

- ▶ When matching blue tooth, please make sure the chair is in power on status, otherwise it can't search the chair.
- ▶ If searching IT-8500-X3, but can't match well, please try connecting match.
- ▶ Please pay attention to Android System updating on our homepage.

### Equipment requirements

- ▶ Flat PC or other intelligent mobiles which must be with blue tooth function.
- ▶ With high than V2.2 Android System.

## ▶ NAME AND FUNCTION OF EACH COMPONENT

Note:

1. Under auto mode or manual mode, it will go back to home page as below drawing 10 seconds after without any operating.

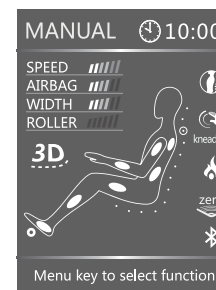

Home page in manual mode

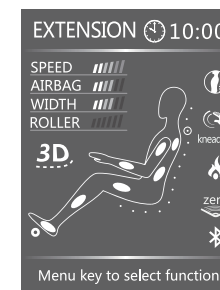

Home page in auto mode

#### ⚠ Caution

- ▶ During working, click “MENU” twice, it will go back to home page immediately.
- ▶ In the home page, under manual mode or auto mode, click the left and right button to adjust air pressure intensity; under manual mode, click up and down, to adjust massage wheels speed.
- ▶ Click “AUTO” to choose auto program directly.

#### ⚠ Caution

- ▶ Please do not disassemble the product to avoid any defective problems.
- ▶ Please do not splash water and other liquid into the controller to avoid malfunction of keys and error code.
- ▶ Please do not put heavy things on the controller or power cable.

## ► FUNCTIONS AND FEATURES

### 1. Bluetooth audio features

Product is designed with Bluetooth audio connection function. It can play music through connect with android system mobile phone, iPhone, or tablet computer.

### 2. Zero Gravity

This chair uses the NASA zero gravity principle, keeping the legs higher than the heart, imitating weightlessness. This position is known to increase comfort and release stress.

### 3. 3D massage mechanism

The innovative 3D massage mechanism and traveling structure perfectly match ergonomic human engineering.

### 4. Six levels of massage intensity

It's 6 levels of massage intensity to select on manual mode, and you can select suitable massage intensity according to your body condition and massage time.

### 5. Air pressure massage

Air pressure for back, waist, shoulder, arm, buttock, calf, and feet.

### 6. Diversified massage modes

Diversified massage modes: knocking, kneading, knocking, kneading, shiatsu, which act as a professional massagist.

### 7. S shape massage track

### 8. Swing function

Product including swing function, which makes the waist have a thorough relaxation.

## ► APP DOWNLOAD AND INSTALLATION

### Bluetooth connection method

Apple ios is different from android, please see the details below:

#### Apple ios: (ipad for example)

1, Open App store , at the top right corner input keywords like "message chair" and so on to download apple's application program, in the application program users open bluetooth and connect it with message chair. Remind: apple equipment that is with bluetooth 4.0 can get connection with the chair's bluetooth. Please see the picture below. Click "GET" at the top right corner, users can download and fix the searched software.

2, open "message chair " , enter into APP program, at first connection, please input apple ID user name and code. After successful registering, click the "setting" "bluetooth" and get connection.

### Blue tooth

- This product has blue tooth connecting function via audio devices.  
Open blue tooth from audio devices, match well with IT-8500-X3 for music play.
- There is extra audio inputting cable for other audio devices next to the controller socket. (optional)