

Body-Solid®

Built for Life

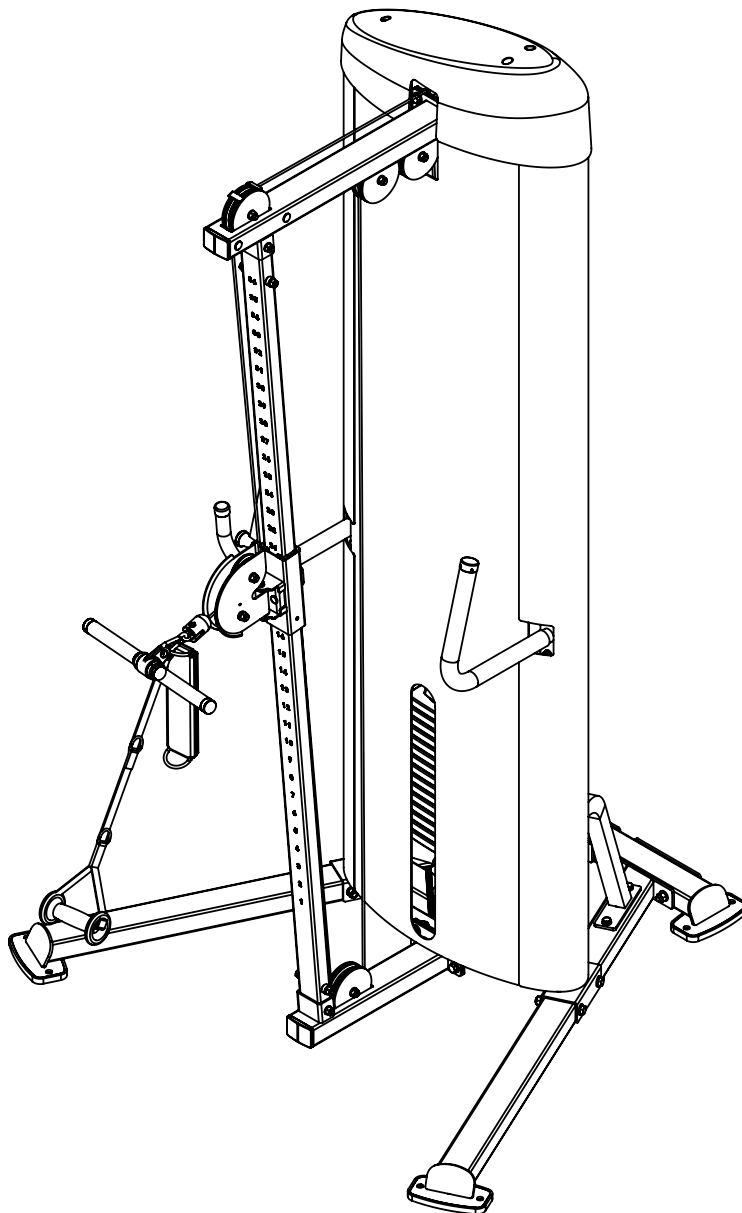

S2CC

Assembly & Instructions

OWNER'S & MANUAL

v. S2CC-102816

Warning, Safety & Maintenance

Be sure that all users carefully read and understand all warning, safety and maintenance labels on the machine before each use. Failure to do so may result in death or serious injury.

It is imperative that you retain this Owner's Manual and be sure all warning labels are legible and intact. Replacement Owner's Manuals and warning labels are available from your local Body-Solid dealer.

If you have any questions about the operation, set up or maintenance of this machine please call our customer service department at 1 (800) 556-3113.

THERE IS A RISK ASSUMED BY INDIVIDUALS WHO USE THIS TYPE OF EQUIPMENT. TO MINIMIZE RISK, YOU MUST FOLLOW THESE RULES:

1. Inspect equipment before each workout. Check that all nuts, bolts, screws and pop pins are in place and fully tightened. Also, before use, check cables for signs of wear. Replace all worn parts immediately. Never use machine if any parts are damaged or missing. **FAILURE TO FOLLOW THESE RULES MAY RESULT IN SERIOUS INJURY.**
2. Keep clear of the cables and all moving parts when the machine is in use.
3. Always make sure all Snap Links are closed when doing any cable/pulley/strap exercises.
4. Exercise with care. Perform your exercises at a smooth moderate pace; never perform jerky or uncoordinated movements that may cause injury.
5. It is recommended that you should workout with a training partner.
6. Do not allow children or minors to play on or around this equipment.
7. If unsure of proper use of equipment, call your local Body-Solid distributor or the Body-Solid customer service department at 1-800-556-3113.
8. **WARNING:** Consult your physician before starting your exercise program. For your own safety, do not begin any exercise program without proper instruction. RAL8-6-03 WC-54

MAINTENANCE SCHEDULE		D A I L Y	W E E K L Y
Cables:	Check tension, end fittings, and coating	✓	
	Check that locking nut at weight stack is tight		✓
Upholstery:	Wipe down and dry	✓	✓
	Clean and condition		
Frame:	Wipe down and dry	✓	✓
	Polish / Wax		
Chrome:	Wipe down and dry	✓	✓
	Polish / Lubricate		
Nuts / Bolts / Fasteners:	Tighten and / or adjust as needed		✓
Guide Rods:	Lubricate and clean		✓
Linear Rods:	Lubricate and clean		✓
Seat Sleeves:	Lubricate and clean		✓
Adjustments / Locking Pins / Tightening Knobs			✓
Weight Stack Pins			✓
Warning Instruction Labels			✓
Springs / Pop Pins		✓	
Anti Skid Surfaces			✓
Hand Grips / Rollers			✓

For Body-Solid Customer Service
Call 1-800-556-3113
#MSSTKR0803

WARNING

Safety and Maintenance of Cables

IMPORTANT: Cables are wear items. It is your responsibility to prevent unexpected breakage. **Cable inspection should be performed daily.** Inspect all cables, the nylon coating on all cables, and the area near the fitting at each end of each cable. **Replace any damaged or worn cable immediately.** Do not allow the machine to be used until damaged or worn cables are replaced. Using or allowing a machine to be used with a suspect cable can result in serious injury. See Owner's Manual for more information.

For Body-Solid Customer Service
Call 1-800-556-3113



Table of Contents

- SAFETY INSTRUCTIONS..... PAGE 4
- PREPARATION..... PAGE 5
- HARDWARE LIST..... PAGE 6
- HARDWARE ILLUSTRATION..... PAGE 8
- PART / LIST ILLUSTRATION..... PAGE 13
- ASSEMBLY INSTRUCTIONS..... PAGE 20
- EXPLODED VIEW..... PAGE 31
- CONTACT PAGE..... PAGE 32

Important Safety Instructions

Before beginning any fitness program, you should obtain a complete physical examination from your physician.

*Il est conseillé de subir un examen médical complet avant d'entreprendre tout programme d'exercice.
Si vous avez des étourdissements ou des faiblesses, arrêtez les exercices immédiatement.*

Antes de comenzar cualquier programa de ejercicios, deberías tener un examen físico con su doctor.

When using exercise equipment, you should always take basic precautions, including the following:

- Read all instructions before using the **S2CC**. These instructions are written to ensure your safety and to protect the unit.
- **Do not remove any safety labels from the machine.**
- Do not allow children on or near the equipment.
- Use the equipment only for its intended purpose as described in this guide. Do not use accessory attachments that are not recommended by the manufacturer. Such attachments might cause injuries.
- Wear proper exercise clothing and shoes for your workout, no loose clothing.
- Keep hands, limbs, loose clothing, and long hair well out of the way of all moving parts.
- Use care when getting on or off the unit.
- Do not overexert yourself or work to exhaustion.
- If you feel any pain or abnormal symptoms, stop your workout immediately and consult your physician.
- Never operate unit when it has been dropped or damaged. Return the equipment to a service center for examination and repair.
- Never drop or insert objects into any opening in the equipment.
- Always check the unit and its cables before each use. Make sure that all fasteners and cables are secure and in good working condition.
- Do not use the equipment outdoors or near water.

Personal Safety During Assembly

- Before beginning assembly, please take the time to read the instructions thoroughly.
- Read each step in the assembly instructions and follow the steps in sequence. Do not skip ahead. If you skip ahead, you may learn later that you have to disassemble components and that you may have damaged the equipment.
- Assemble and operate the **S2CC** on a solid, level surface. Locate the unit a few feet from the walls or furniture to provide easy access.

The **S2CC** is designed for your enjoyment. By following these precautions and using common sense, you will have many safe and pleasurable hours of healthful exercise with your Body-Solid **ProClub Cable Column**.

After assembly, you should check all functions to ensure correct operation. If you experience problems, first recheck the assembly instructions to locate any possible errors made during assembly. If you are unable to correct the problem, call the dealer from whom you purchased the machine or call **1-800-556-3113** for the dealer nearest you.

Obtaining Service

Please use this Owner's Manual to make sure that all parts have been included in your shipment. When ordering parts, you must use the part number and description from this Owner's Manual. Use only Body-Solid replacement parts when servicing this machine. Failure to do so will void your warranty and could result in personal injury.

For information about product operation or service, check out the official Body-Solid website at www.bodysolid.com or contact an authorized Body-Solid dealer or a Body-Solid factory-authorized service company or contact Body-Solid customer service at one of the following:

Toll Free: 1-800-556-3113
Phone: 1-708-427-3555
Fax: 1-708-427-3556
Hours: M-F 8:30-5:00 CST
E-Mail: service@bodysolid.com

Or write to: Body-Solid, Inc.
Service Department
1900 S. Des Plaines Ave.
Forest Park, IL 60130 USA

Retain this Owner's Manual for future reference. If you need to order replacement parts please be prepared to provide the following information when contacting us so that we can assist you better.

- 1. Model Number**
- 2. Place of Purchase**
- 3. Serial Number (S/N)**
- 4. Part # and Description**

Preparation

Thank you for purchasing the **S2CC**. This bench is part of the Body-Solid line of quality strength training machines, which lets you target specific muscle groups to achieve better muscle tone and overall body conditioning. To maximize your use of the equipment please study this Owner's Manual thoroughly.

Required Tools

The basic tools that you must obtain before assembling the **S2CC** include but are not limited to:

- Metric Allen Key Set
- Standard Allen Key Set
- Standard Wrench Set
- Metric Wrench Set
- Adjustable Wrench
- Screwdriver (standard and/or phillips)

Installation Requirements

Follow these installation requirements when assembling the **S2CC**:

Set up the **S2CC** on a solid, flat surface. A smooth, flat surface under the machine helps keep it level. A level machine has fewer malfunctions.

Provide ample space around the machine. Open space around the machine allows for easier access.

Insert all bolts in the same direction. For aesthetic purposes, insert all bolts in the same direction unless specified (in text or illustrations) to do otherwise.

Leave room for adjustments. Tighten fasteners such as bolts, nuts, and screws so the unit is stable, but leave room for adjustments. Do not fully tighten fasteners until instructed in the assembly steps to do so.

Fill out and mail the warranty card.

Assembly Tips

Read all "Notes" on each page before beginning each step.

While you may be able to assemble the **S2CC** using the illustrations only, important safety notes and other tips are included in the text.

Some pieces may have extra holes that you will not use. Use only those holes indicated in the instructions and illustrations.

NOTE: With so many assembled parts, proper alignment and adjustment is critical. While tightening the nuts and bolts, be sure to leave room for adjustments.

NOTE: The bottles that are marked "Poison" is your touch up paint. Keep away from children.

CAUTION: Obtain assistance! If you feel like you can't assemble the **S2CC** by yourself then do not attempt to do so as this could result in injury. Review the installation requirements before proceeding with the following steps.

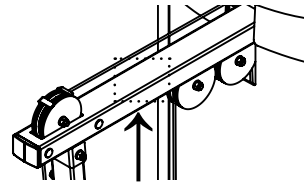

Your S/N# can
be found here

Body-Solid continually seeks ways to improve the performance, specifications and product manuals in order to ensure that only superior products are released from our factories. Please take the time to carefully read through this manual thoroughly. Instructions contained in this document are not intended to cover all details or variations possible with Body-Solid equipment, or to cover every contingency that may be met in conjunction with installation, operation, maintenance or troubleshooting of the equipment. Even though we have prepared this manual with extreme care, neither the publisher nor the author can accept responsibility for any errors in, or omission from, the information given. Should additional information be required, or should situations arise that are not covered by this manual, the matter should be directed to your local Body-Solid representative, or the Service Department at Body-Solid Inc. in Forest Park, Illinois.

S 2 C C Hardware List

Part#	Size	Description	Quantity
1	M12X110mm	HEX HEAD BOLT	4 PCS.
2	M12X105mm	HEX HEAD BOLT	4 PCS.
3	M12X35mm	HEX HEAD BOLT	8 PCS.
4	M10X100mm	HEX HEAD BOLT	2 PCS.
5	M10X90mm	HEX HEAD BOLT	2 PCS.
6	M10X55mm	HEX HEAD BOLT	1 PCS.
7	M10X50mm	HEX HEAD BOLT	7 PCS.
8	M10X30mm	HEX HEAD BOLT	12 PCS.
9	M8X100mm	HEX HEAD BOLT	1 PCS.
10	M8X25mm	BUTTON HEAD CAP SCREW	4 PCS.
11	M6X16mm	PHILLIPS HEAD SCREW	3 PCS.
12	M8X8mm	SET SCREW	4 PCS.
13	3/8"X2.0"	SOCKET HEAD CAP SCREW	1 PCS.
14	10-32X1/8"	SET SCREW	12 PCS.
15	5/16"X1.25"	SHOULDER BOLT	1 PCS.

S 2 C C Hardware List

Part#	Size	Description	Quantity
40	M12	NYLON LOCK NUT	16 PCS.
41	M10	NYLON LOCK NUT	12 PCS.
42	M8	NYLON LOCK NUT	5 PCS.
43	5/16"-18	NYLON LOCK NUT	1 PCS.
44	1/2"	FLANGE HEX NUT	2 PCS.
45	1/2"	HEX NUT	1 PCS.
50	M12	FLAT WASHER	32 PCS.
51	M10	FLAT WASHER	36 PCS.
52	M8	FLAT WASHER	10 PCS.
53	M6	FLAT WASHER	3 PCS.
54	3/8"	LOCK WASHER	1 PCS.

S 2 C C Hardware Illustration

Part #1 HEX HEAD BOLT M12X110mm QTY. 4

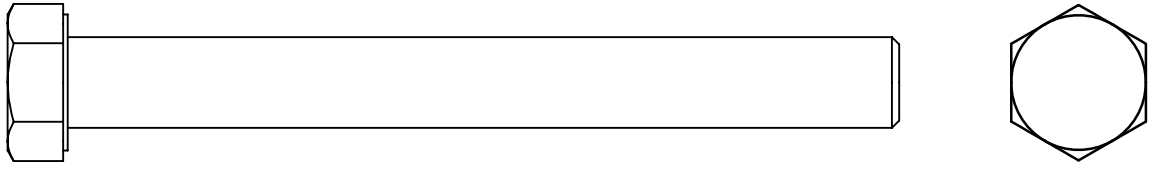

Part #2 HEX HEAD BOLT M12X105mm QTY. 4

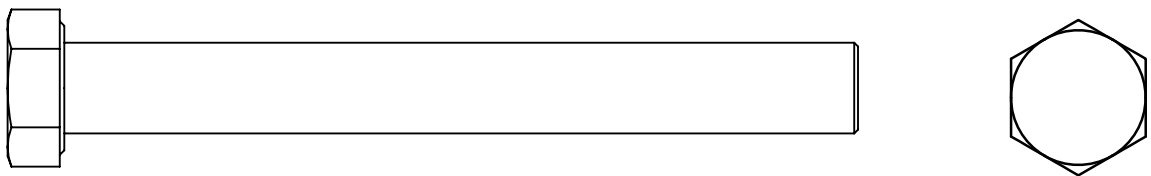

Part #3 HEX HEAD BOLT M12X35mm QTY. 8



Part #4 HEX HEAD BOLT M10X100mm QTY. 2

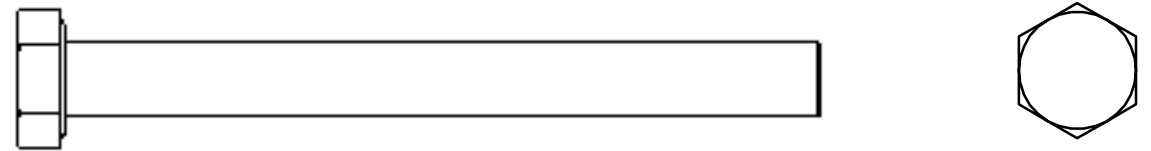

Part #5 HEX HEAD BOLT M10X90mm QTY. 2

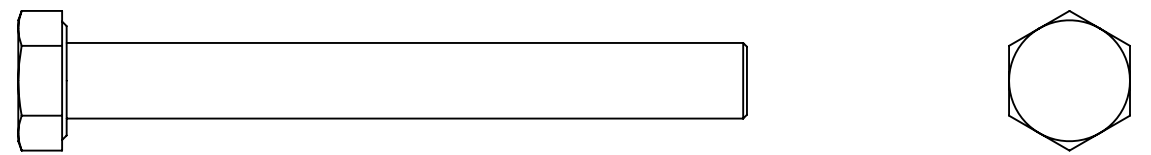

Part #6 HEX HEAD BOLT M10X55mm QTY. 1

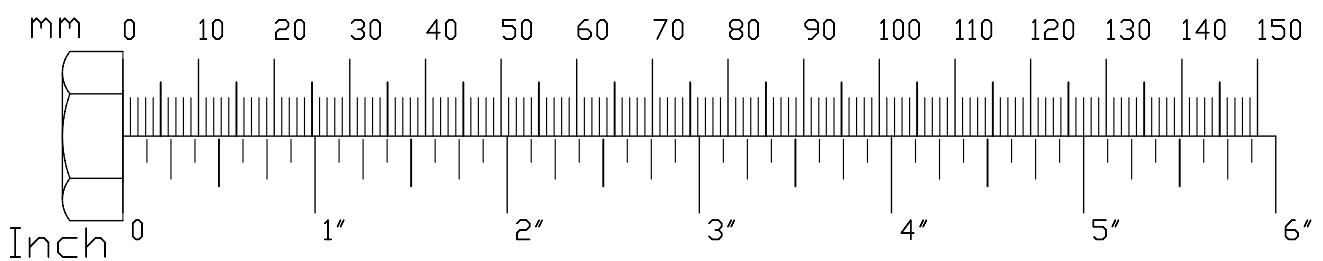

S 2 C C Hardware Illustration

Part #7 HEX HEAD BOLT M10X50mm

QTY. 7

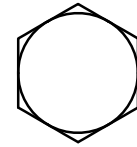
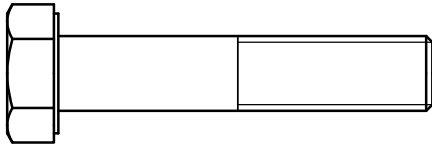

Part #8 HEX HEAD BOLT M10X30mm

QTY. 12

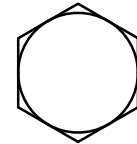
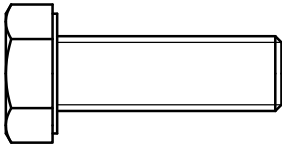

Part #9 HEX HEAD BOLT M8X100mm

QTY. 1

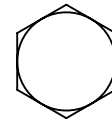
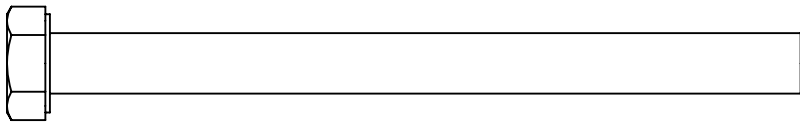

Part #10 BUTTON HEAD CAP SCREW M8X25mm

QTY. 4

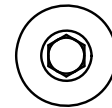
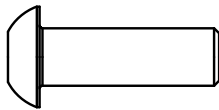

Part #11 PHILLIPS HEAD SCREW M6X16mm

QTY. 3

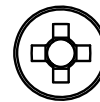
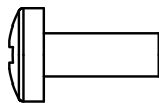

Part #12 SET SCREW M8X8mm

QTY. 4

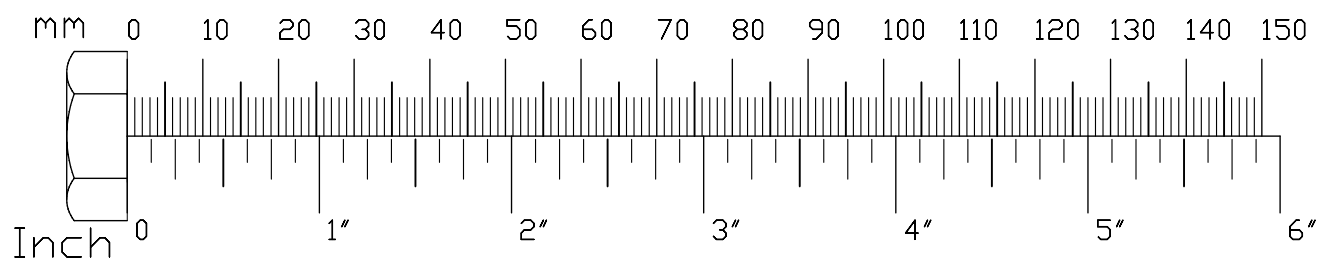

S 2 C C Hardware Illustration

Part #13 SOCKET HEAD CAP SCREW 3/8"X2.0"

QTY. 1

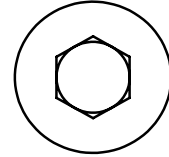
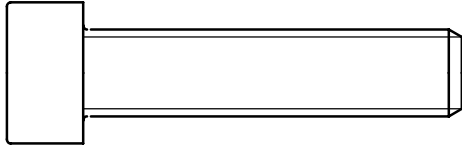

Part #14 SET SCREW 10-32X1/8"

QTY. 12



Part #15 SHOULDER BOLT 5/16"X1.25"

QTY. 1

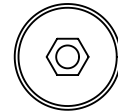
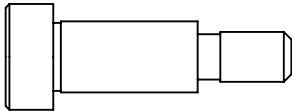

Part #40 NYLON LOCK NUT M12

QTY. 16

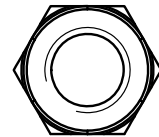
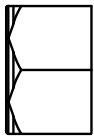

Part #41 NYLON LOCK NUT M10

QTY. 12



Part #42 NYLON LOCK NUT M8

QTY. 5

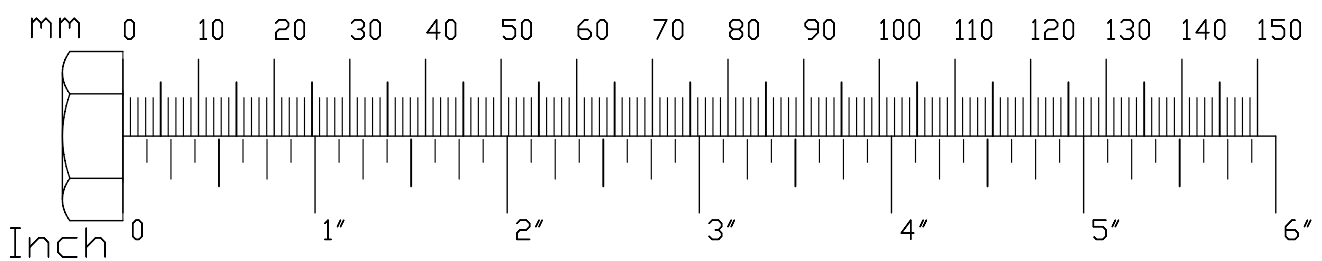
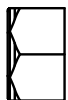

S 2 C Hardware Illustration

Part #43 NYLON LOCK NUT 5/16"

QTY. 1

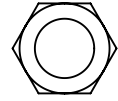
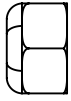

Part #44 FLANGE NUT 1/2"

QTY. 2

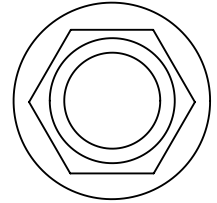
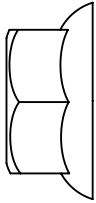

Part #45 HEX NUT 1/2"

QTY. 1

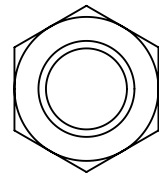
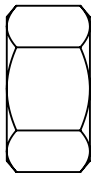

Part #50 FLAT WASHER M12

QTY. 32

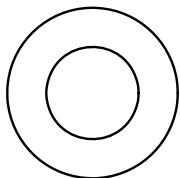

Part #51 NYLON LOCK NUT M10

QTY. 36

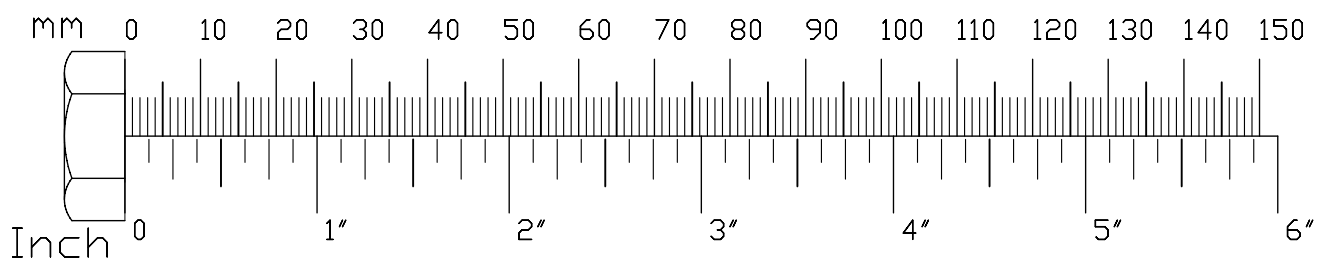
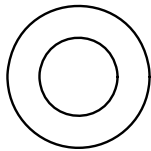

S 2 C C Hardware Illustration

Part #52 FLAT WASHER M8

QTY. 10

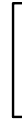
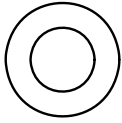

Part #53 FLAT WASHER M6

QTY. 3



Part #54 LOCK WASHER 3/8"

QTY. 1

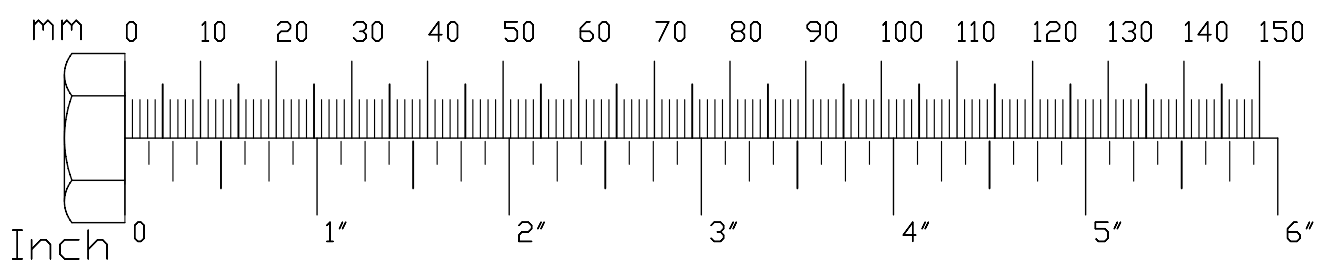
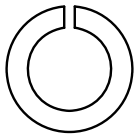

S2CC Parts List/Illustration

PART A - LEFT BASE FRAME, 1PC.

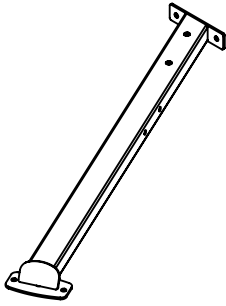

PART F - RIGHT BRACE , 1PC.

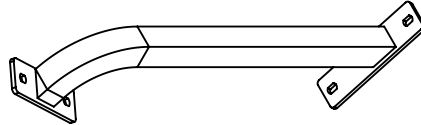

PART B - RIGHT BASE FRAME, 1PC.

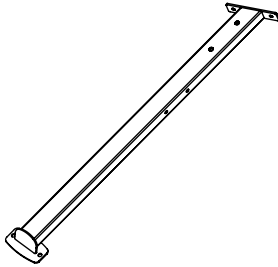

PART G - LEFT BRACE, 1PC.

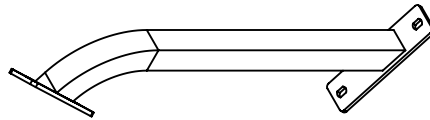

PART C - REAR BASE FRAME, 1PC.

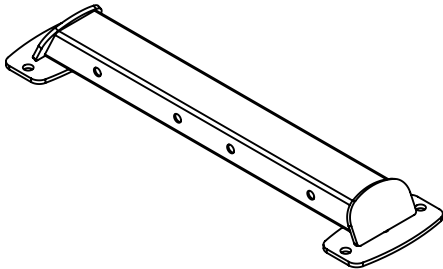

PART H - FRONT BASE FRAME , 1PC.

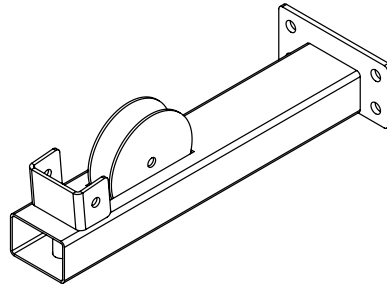

PART D - STEEL PLATE, 2PCS.

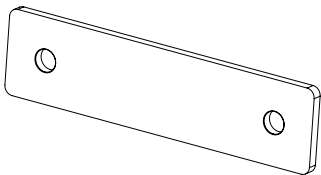

PART J - GUIDE POST , 1PCS.

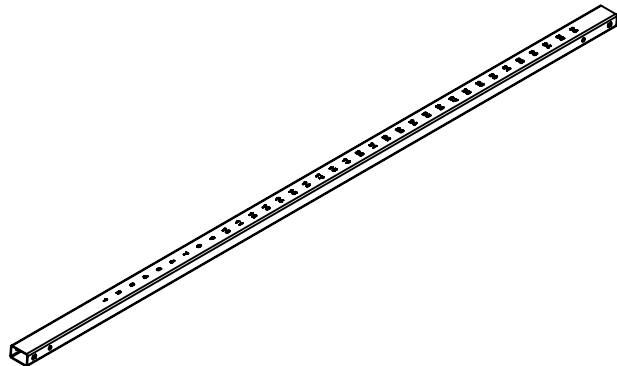

S2CC Parts List/Illustration

PART K - TOP FRAME , 1PC.

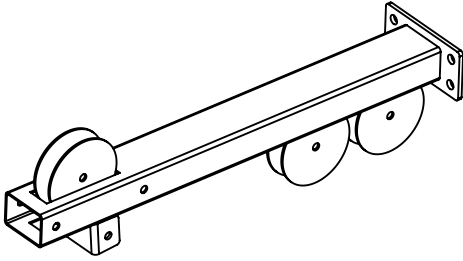

PART WA - WEIGHT STACK FRAME, 1PC.

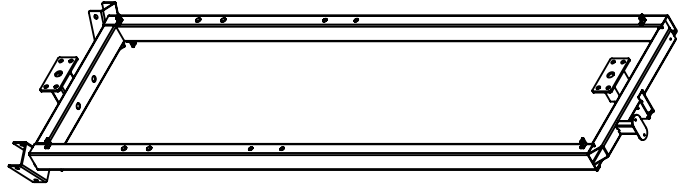

PART L - SWIVEL ADJUSTER, 1PC.

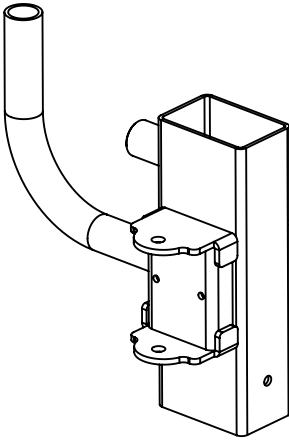

PART WB - SHORT SIDE SHROUD, 1PC.

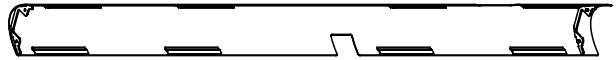

PART M - PULLEY HOLDER, 1PCS.

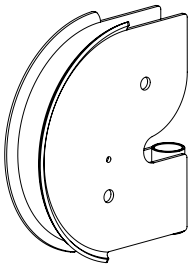

PART WC - LONG SIDE SHROUD, 1PC.

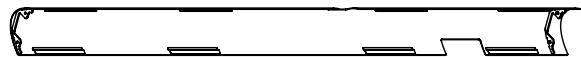

PART N - HANDLE, 2PCS.

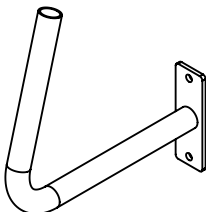

PART WD - CHROME GUIDE ROD, 2PCS.

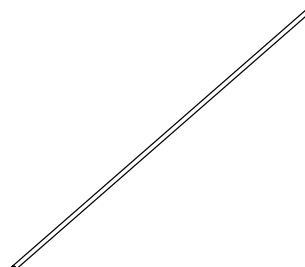

S2CC Parts List/Illustration

PART WE - FRONT SHROUD, 1PC.

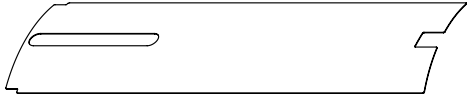

PART #60 - FOOT PAD, 4PCS.

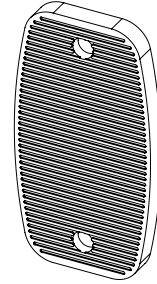

PART WF - REAR SHROUD, 1PCS.



PART #61 - ADJUSTABLE LEVELER, 1PCS.

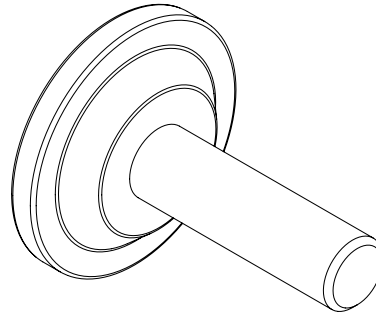

**PART #62 - PLASTIC END CAP, 2PCS.
75x50mm**

PART WG - TOP SHROUD, 1PCS.

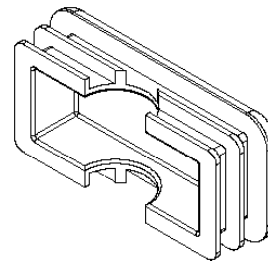
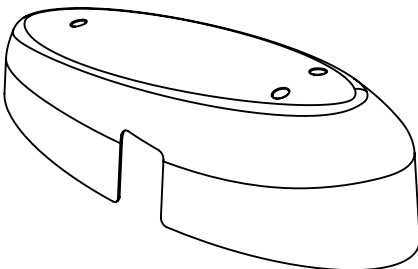

PART #63 - LARGE PULLEY, 4PCS.

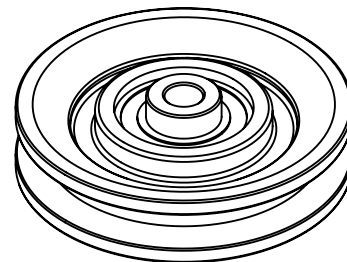

S2CC Parts List/Illustration

PART #64 - SMALL PULLEY, 4PCS.

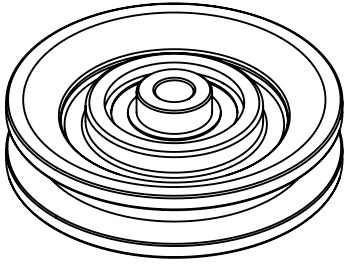

PART #68 - SNAP LINK, 1PC.

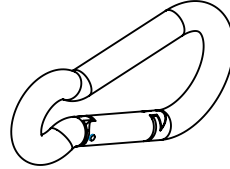

PART #65 - RUBBER SLEEVE, 2PCS.

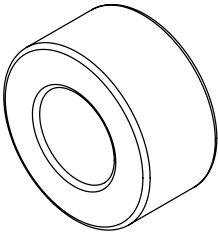

**PART #69 - BUSHING, 2PCS.
Ø28xØ22x18mm**

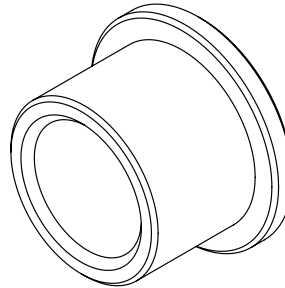

PART #66 - CABLE BUMPBER, 1PC.

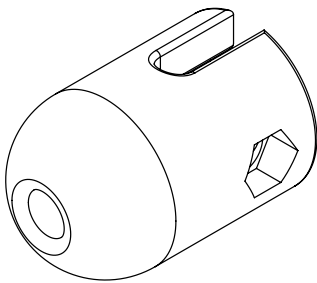

**PART #70 - STEEL TUBE, 1PC.
Ø16xØ8.5x75mm**

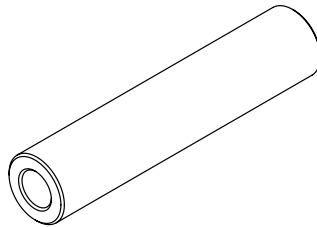

PART #67 - CABLE CONNECTOR, 1PC.

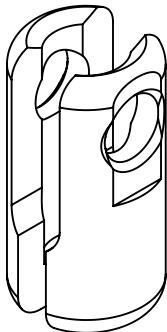

PART #71 - PLASTIC STOPPER, 2PCS.

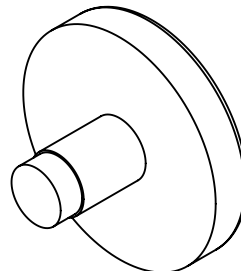

S 2 C C Parts List/illustration

PART #72 - HANDLE END RING, 1PC.
Ø33xØ26x9.5mm

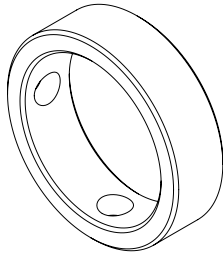

PART #76 - PLASTIC BUSHING, 2PCS.

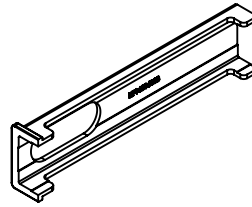

PART #73 - HANDLE GRIP, 1PC.

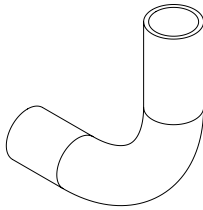

PART #77 - Plug, 4PCS.

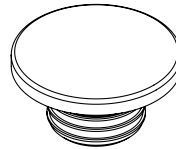

PART #74 - HANDLE END CAP, 1PC.
Ø33xØ26x19mm

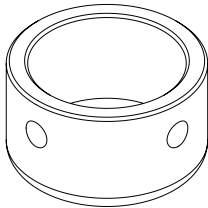

PART #78 - BRACKET, 1PC.

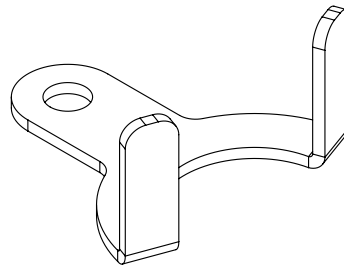

PART #75 - POP PIN, 1PC.

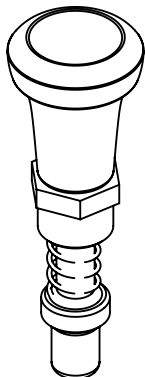

PART #79 - HANDLE END CAP, 2PCS.
Ø39.5xØ32.5x19mm

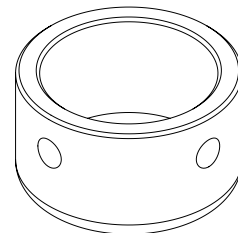

S2CC Parts List/Illustration

PART #80 - HANDLE END RING, 2PCS.
Ø39.5xØ32.5x9.5mm

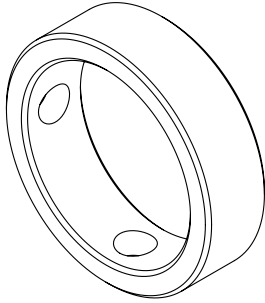

PART #84 - SELECTOR ROD, 1PC.

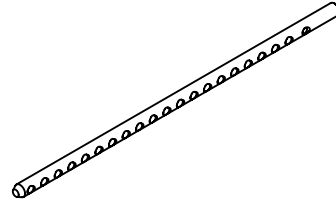

PART #81 - SHAFT COLLAR, 2PCS.

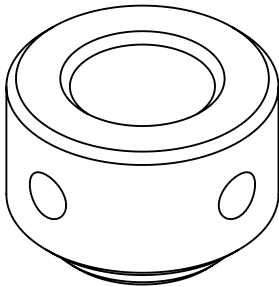

PART #85 - SELECTOR PIN, 1PC.

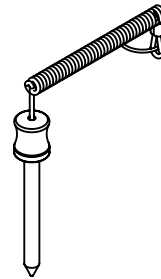

PART #82 - SWIVEL PULLEY BRACKET, 1PC.

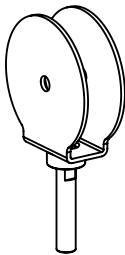

PART #86 - RUBBER DONUT, 2PCS.

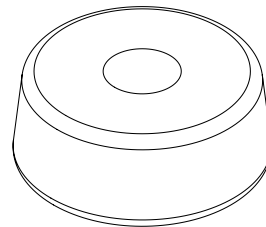

PART #83 - TOP PLATE, 1PC.

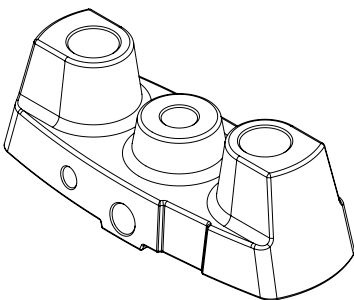

PART #87 - WEIGHT RISER, 2PCS.

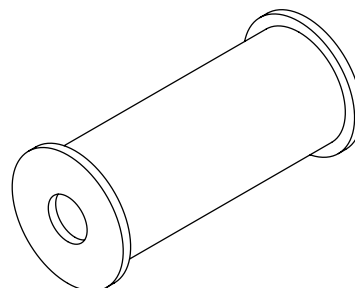

S2CC Parts List/Illustration

PART #88 - ANKLE CUFF, 1PCS.

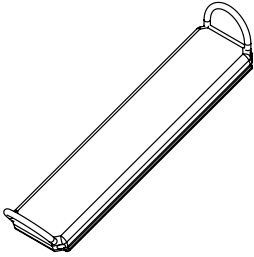

PART #92 - CABLE, 1PC.

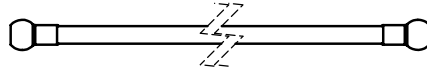

PART #89 - STRAP HANDLE, 2PCS.

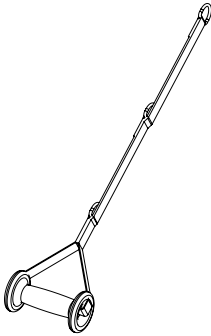

PART #90 - LOW ROW BAR, 1PC

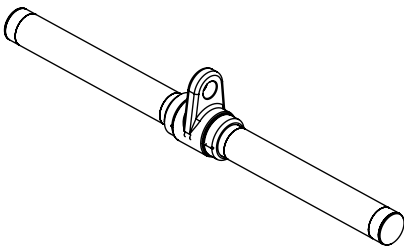

PART #91 - HANDLE GRIP, 2PCS.

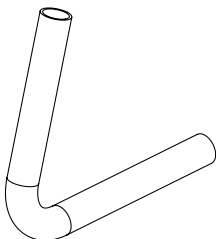

STEP**1**

Be careful to assemble all components in the sequence they are presented.

NOTE:

Finger tighten all hardware in this step. DO NOT wrench tighten unless instructed. Some components may be pre-assembled. Nylon lock nuts will not fully screw onto bolts, they must be wrench tighten to fully go on.

- 1A.** Attach Left & Right Base Frames (**A & B**) to Rear Base Frame (**C**) using:
 - 4 - (#1) M12X110mm Hex Head Bolt
 - 8 - (#50) M12 Flat Washer
 - 4 - (#40) M12 Nylon Lock Nut
 - 2 - (D) Steel Plate

- 1B.** Attach Weight Stack Frame (**WA**) to Left & Right Base Frame (**A & B**) using:
 - 4 - (#2) M12X105mm Hex Head Bolt
 - 8 - (#50) M12 Flat Washer
 - 4 - (#40) M12 Nylon Lock Nut

- 1C.** Attach Front Base Frame (**H**) to Weight Stack Frame (**WA**) using:
 - 4 - (#3) M12X35mm Hex Head Bolt
 - 8 - (#50) M12 Flat Washer
 - 4 - (#40) M12 Nylon Lock Nut

- 1D.** Attach Top Frame (**K**) to Weight Stack Frame (**WA**) using:
 - 4 - (#3) M12X35mm Hex Head Bolt
 - 8 - (#50) M12 Flat Washer
 - 4 - (#40) M12 Nylon Lock Nut

- 1E.** Install Four Plugs (#77) onto Top Frame (**K**).

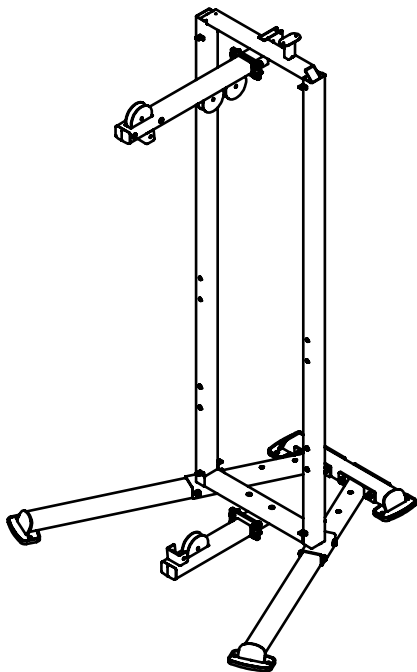

Above shows Step 1 assembled and completed.

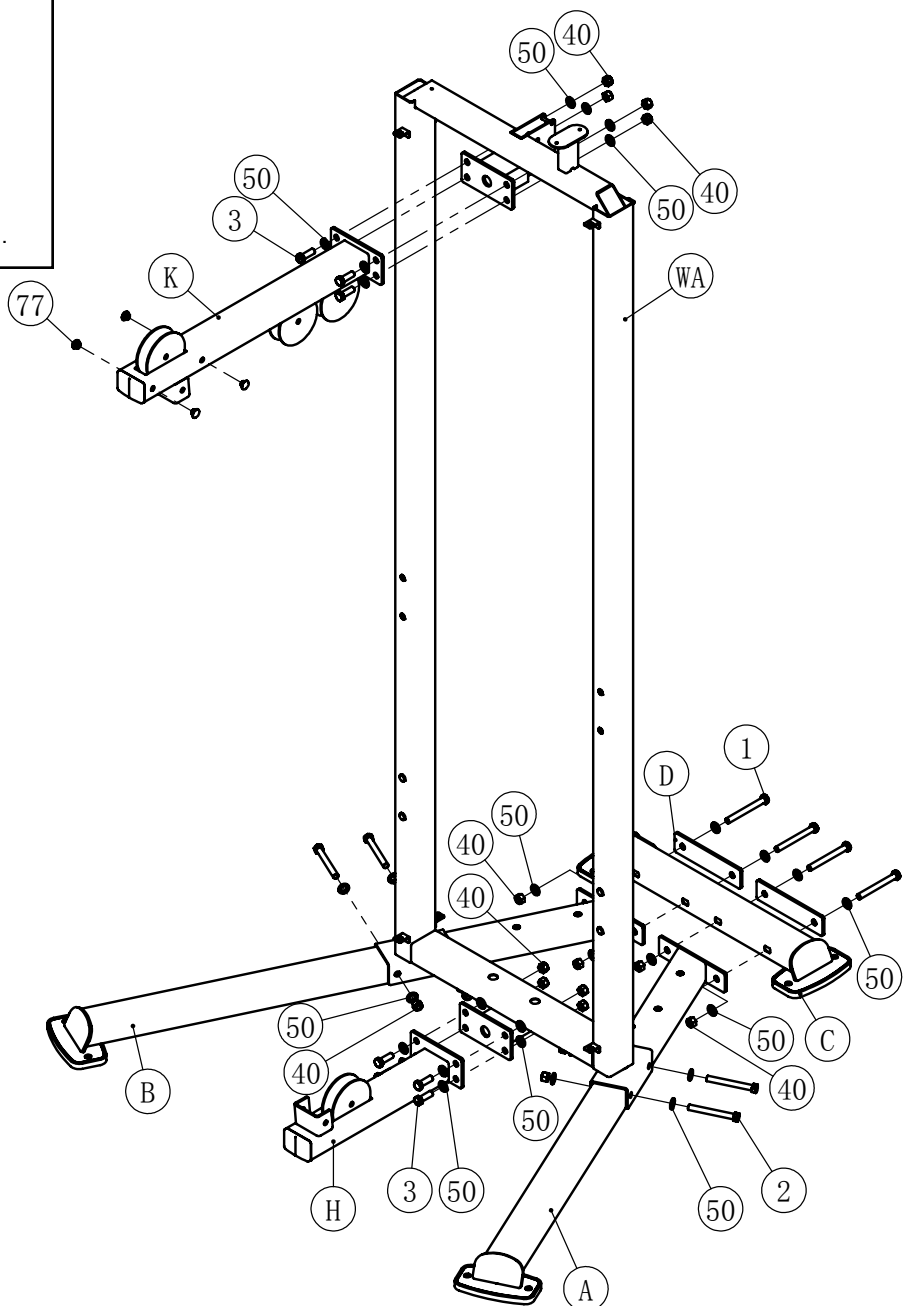

STEP**2**

Be careful to assemble all components in the sequence they are presented.

NOTE:

Finger tighten all hardware in this step. DO NOT wrench tighten unless instructed. Some components may be pre-assembled. Nylon lock nuts will not fully screw onto bolts, they must be wrench tighten to fully go on.

- 2A.** Attach Guide Post (**J**) to Top & Base Frame (**H & K**) using:
2 - (#5) M10x90mm Hex Head Bolt
4 - (#51) M10 Flat Washer
2 - (#41) M10 Nylon Lock Nut
- 2B.** Install Chrome Guide Rods (**WD**) into the holes in the Weight Stack Frame (**WA**).
- 2C.** Install Weight Risers (**#87**) & Rubber Donuts (**#86**) and slide to the bottom of the Guide Rods

Important Notes:

- 1. Install the rod ends with side holes into the bottom section of the Weight Stack Frame.**
 - 2. If 20pcs of weight plates are to be installed, do not install Weight Risers (87)**
- 2D.** Tilt Guide Rods (**WD**) away from the Weight Stack Frame (**WA**) and install 15pcs of weight plates. Be careful to hold guide rods steadily when installing weight plates.
- 2E.** Install Top Plate & Selector Rod Assembly (**#83**) onto the Guide Rods (**WD**) .
- 2F.** Install Weight Stack Pin (**#85**) using the key ring end through the Swivel Pully Bracket (**#82**).
- 2G.** Install Two 1/2" Flange Hex Nut (**#44**) & Swivel Pulley Bracket (**#82**) onto the Top Plate (**#83**) .
- 2H.** Install Shaft Collars (**#81**) onto the Guide Rods (**WD**)
- 2J.** Slide Shaft Collars (**#81**) upward so they lock the guide rods into position by tightening the four M8x8mm Set Screws (**#12**)

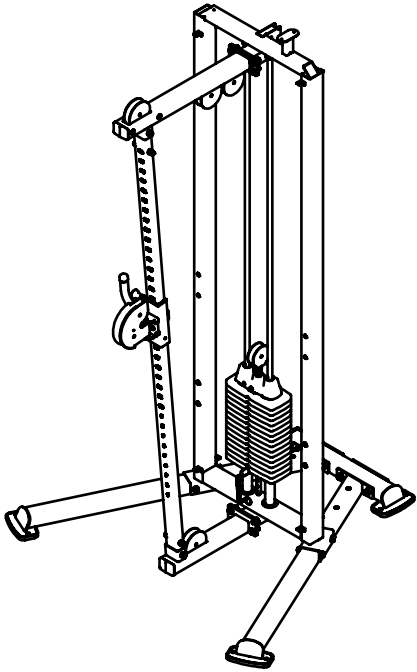

Above shows Step 2 assembled and completed.

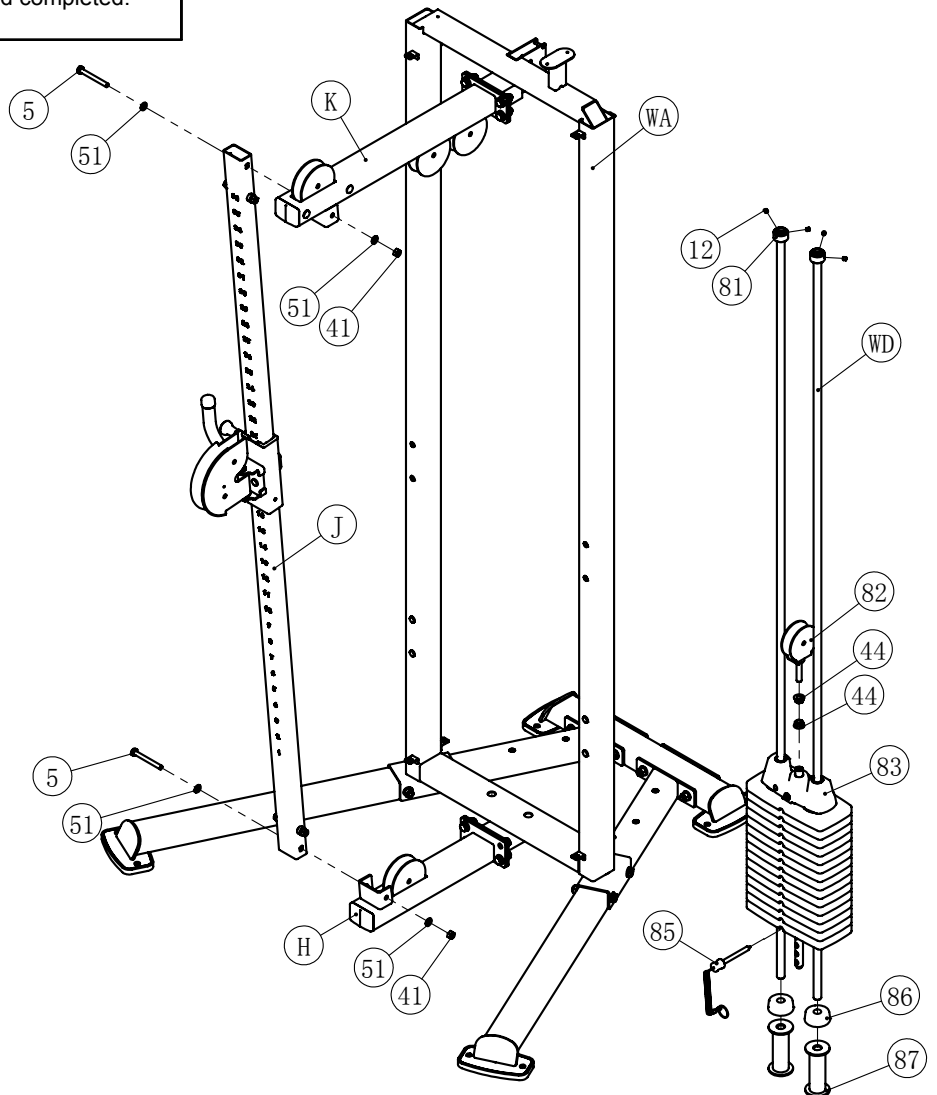

STEP**3**

Be careful to assemble all components in the sequence they are presented.

NOTE:

Finger tighten all hardware in this step. DO NOT wrench tighten unless instructed. Some components may be pre-assembled. Nylon lock nuts will not fully screw onto bolts, they must be wrench tighten to fully go on.

3A. Install Cable (**#92**) while installing Four Large Pulleys (**#63**) and Four Small Pulleys (**#64**) into Frames as shown in Step 3 Drawing using:

- 1 - (**#6**) M10X55mm Hex Head Bolt
- 7 - (**#7**) M10X50mm Hex Head Bolt
- 16 - (**#51**) M10 Flat Washer
- 8 - (**#41**) M10 Nylon Lock Nut
- 1 - (**#78**) Bracket

3B. Attach Two Handles (**N**) to Weight Stack Frame (**WA**) using:

- 4 - (**#8**) M10X30mm Hex Head Bolt
- 4 - (**#51**) M10 Flat Washer

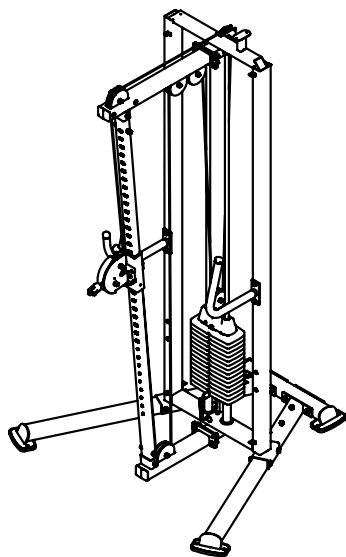

Above shows Step 3 assembled and completed.

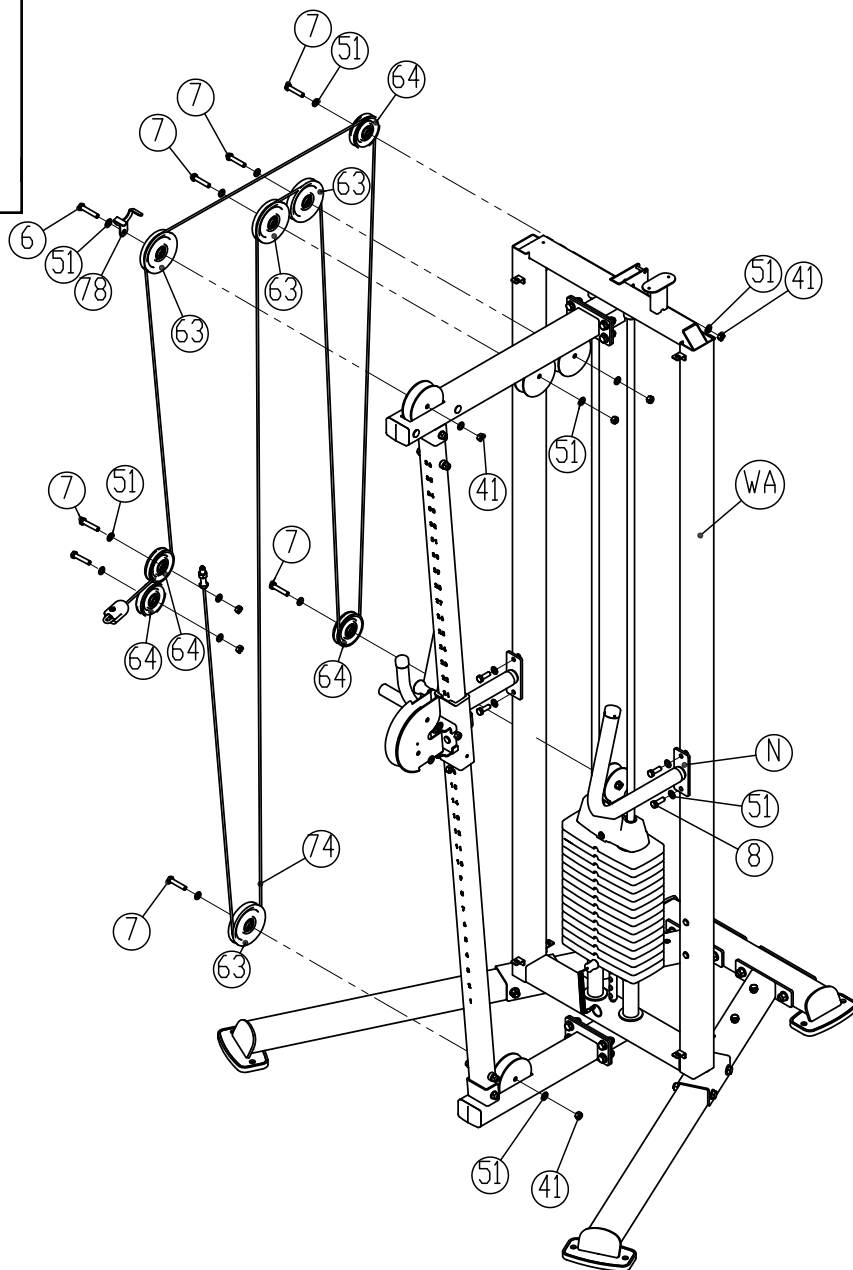

STEP**4**

Be careful to assemble all components in the sequence they are presented.

NOTE:

Finger tighten all hardware in this step. DO NOT wrench tighten unless instructed. Some components may be pre-assembled. Nylon lock nuts will not fully screw onto bolts, they must be wrench tighten to fully go on.

- 4A.** Attach Short Metal Shrouds (**WB**) and Long Metal Shrouds (**WC**) to Weight Stack Frame (**WA**) using:
- 4 - (#10) M8X25mm Button Head Cap Screw**
 - 8 - (#52) M8 Flat Washer**
 - 4 - (#42) M8 Nylon Lock Nut**
- 4B.** Bend the Plastic Shrouds (**WF**) and insert them to the side slots of the Metal Shrouds (**WB & WC**).

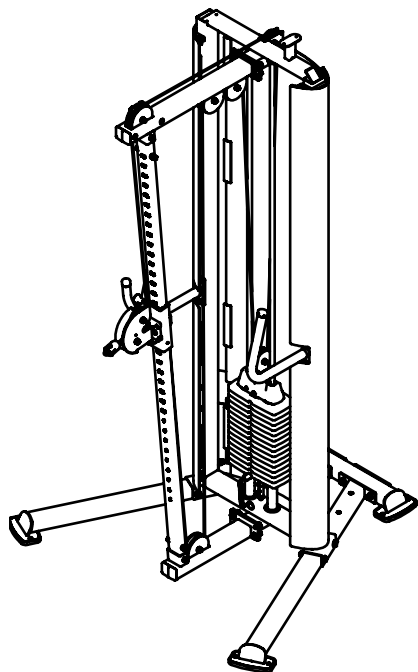

Above shows Step 4 assembled and completed.

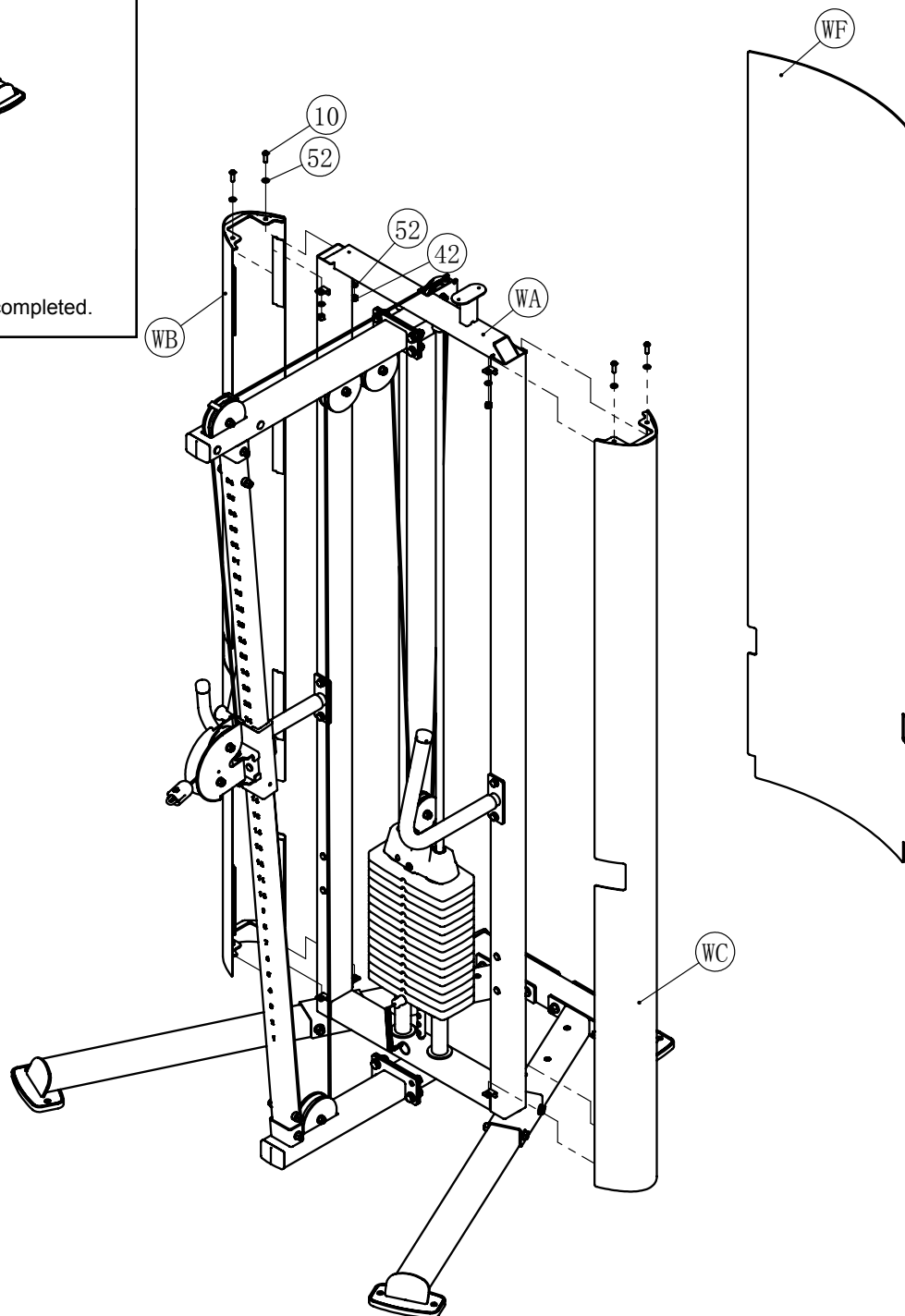

STEP**5**

Be careful to assemble all components in the sequence they are presented.

NOTE:

Wrench tighten ALL hardware at the end of Step 5A. Some components may be pre-assembled. Nylon lock nuts will not fully screw onto bolts, they must be wrench tighten to fully go on.

- 5A.** Attach Left & Right Braces (**G & F**) to Weight Stack Frame (**WA**) and Left & Right Base Frame (**A & B**) using:
 - 8 - (#8) M10X30mm Hex Head Bolt**
 - 8 - (#51) M10 Flat Washer**

- 5B.** Bend the Plastic Shrouds (**WE**) and insert them to the side slots of the Metal Shrouds (**WB & WC**).

- 5C.** Attach Top Shroud (**WG**) to Weight Stack Frame (**WA**) using:
 - 3 - (#11) M6X16mm Phillips Head Screw**
 - 3 - (#53) M6 Flat Washer**

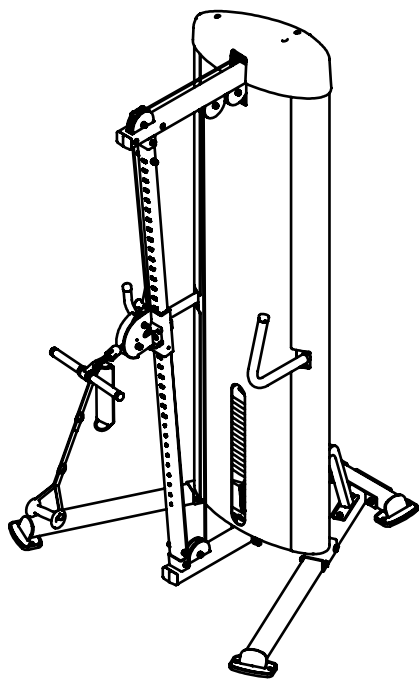

Above shows Step 5 assembled and completed.

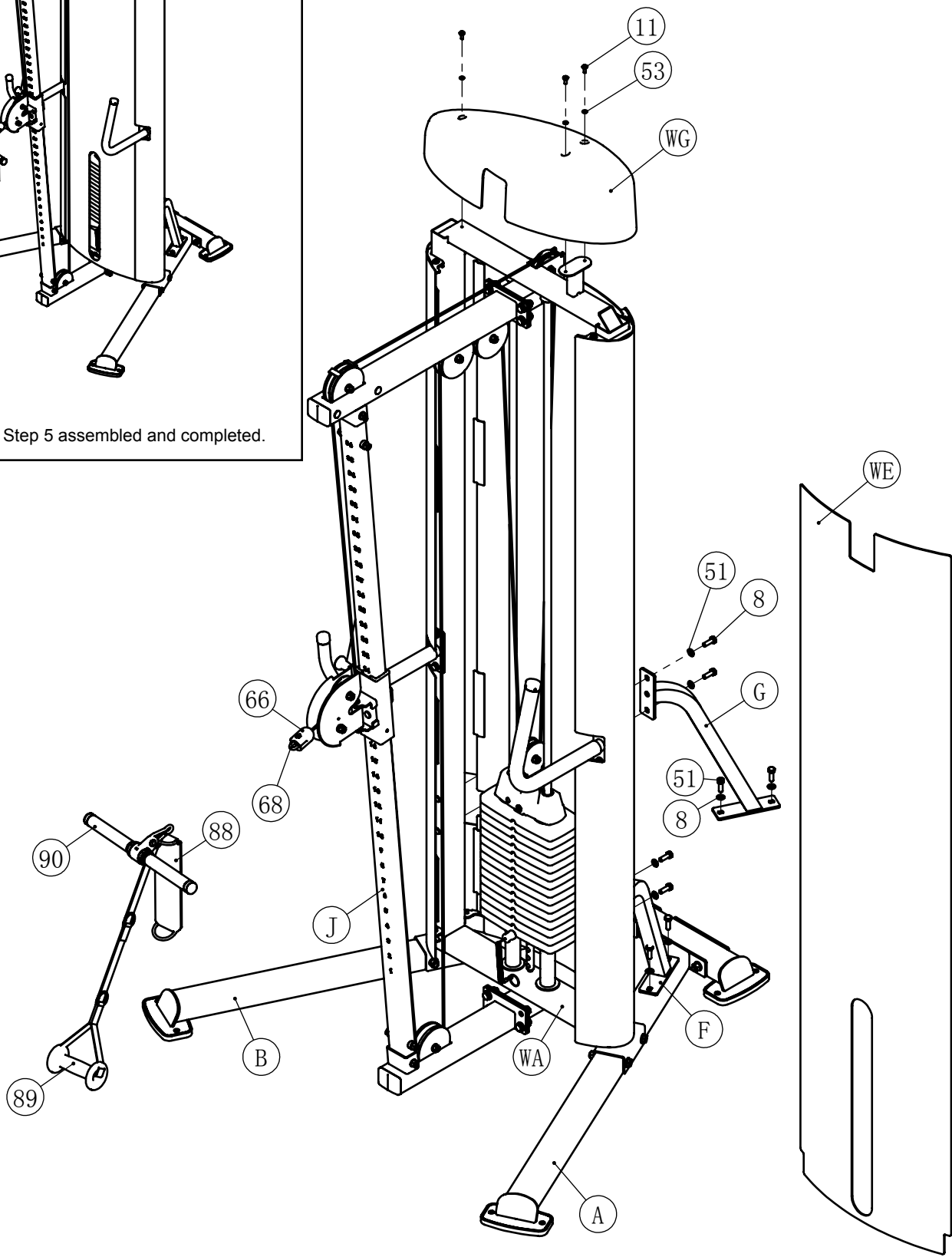

PCL Badge Location



S2CC Exploded View

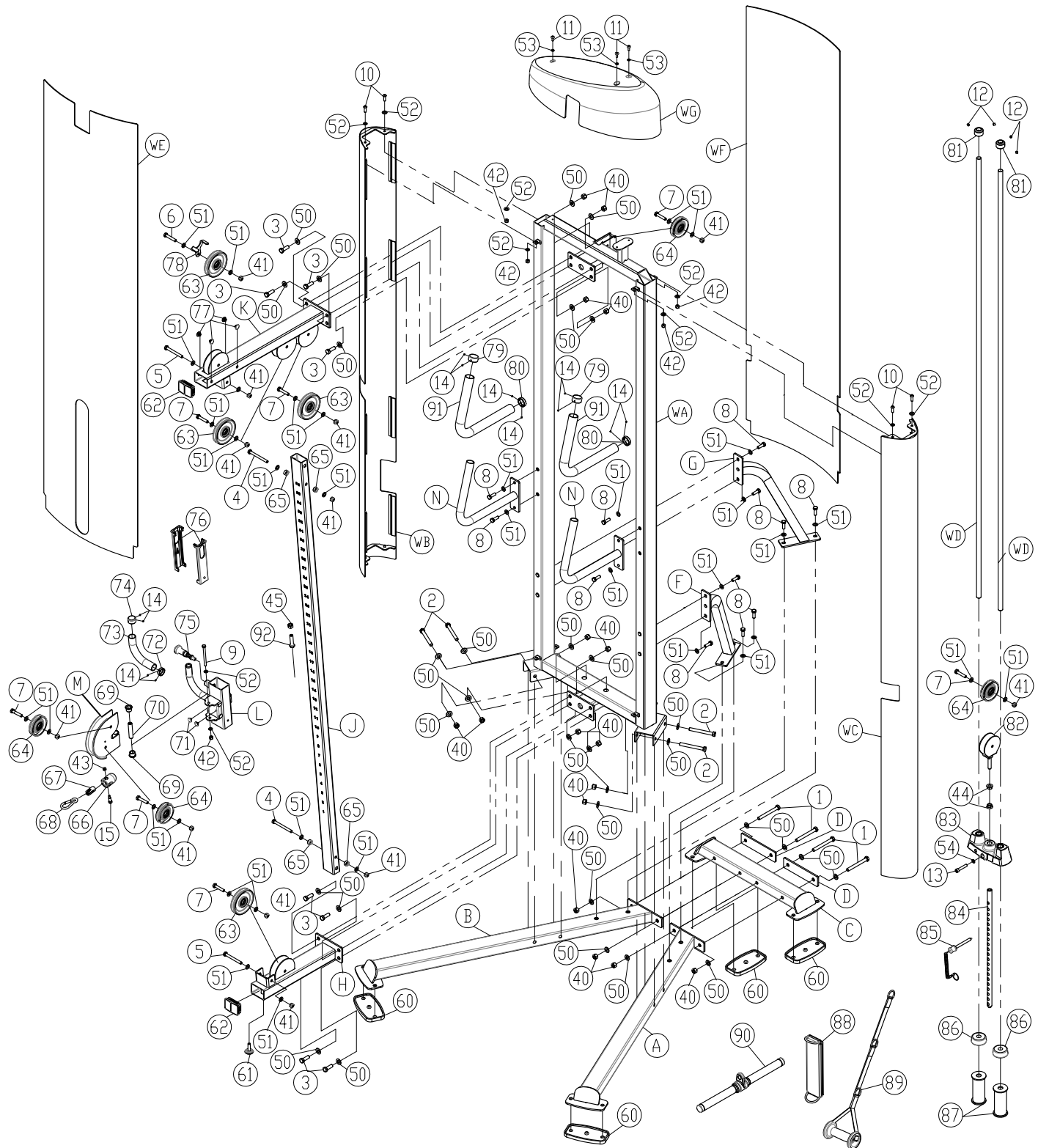

Body-Solid®

Built for Life

S2CC

PLEASE WRITE YOUR SERIAL NUMBER IN THE BOXES BELOW

S/N # 011854-□□-□□-□□□□-□□□□

1900 S. Des Plaines Ave.
Forest Park, IL 60130
Phone:(708)427-3555
Fax:(708)427-3556
Hours: M-F 8:30 - 5:00 CST

www.bodysolid.com