

# Body-Solid®

Built for Life

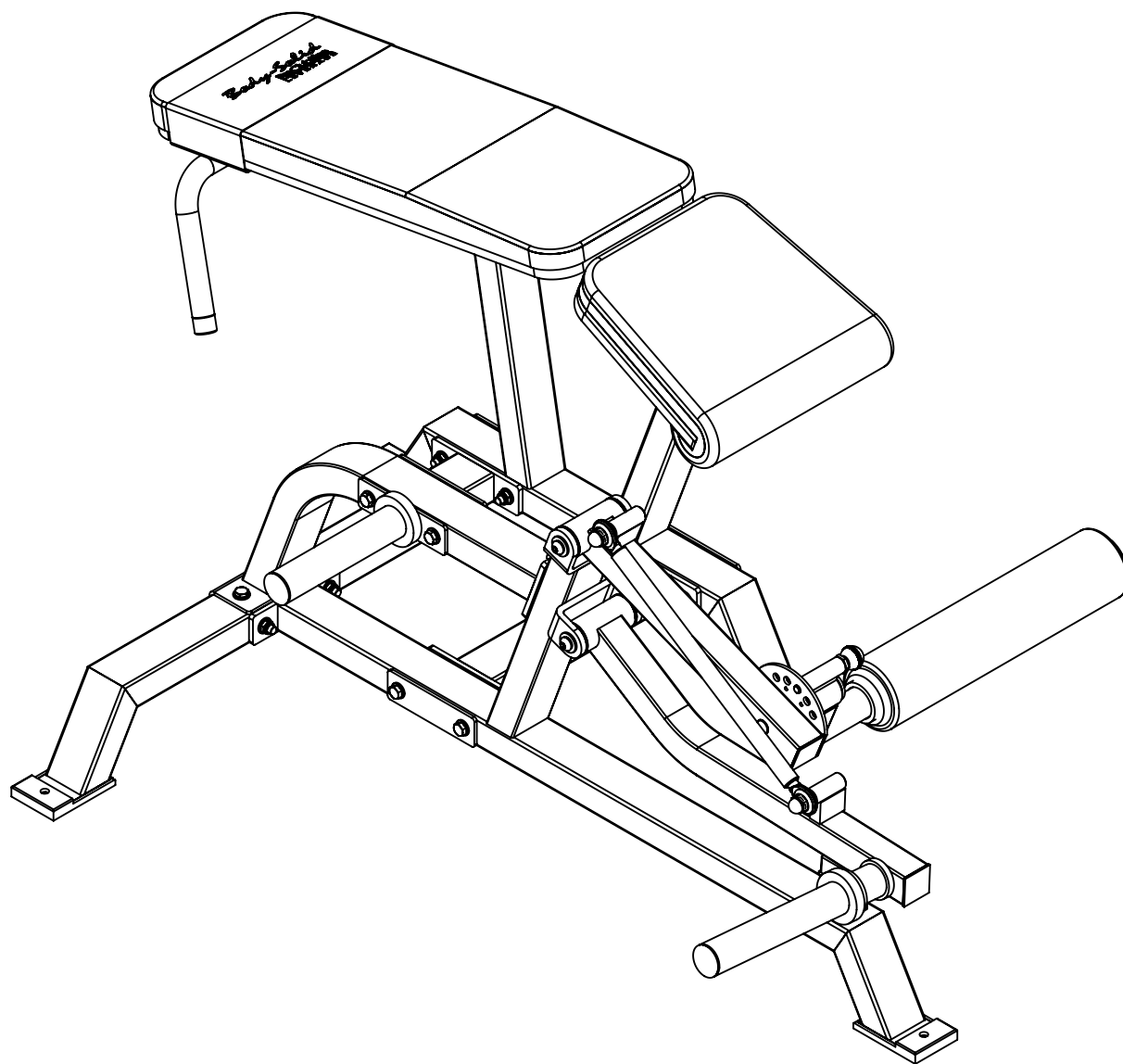

## LVLC

Assembly & Instructions  
**OWNER'S & MANUAL**

V. LVLC-20220322

## Warning, Safety & Maintenance

Be sure that all users carefully read and understand all warning, safety and maintenance labels on the machine before each use. Failure to do so may result in death or serious injury.

It is imperative that you retain this Owner's Manual and be sure all warning labels are legible and intact. Replacement Owner's Manuals and warning labels are available from your local Body-Solid dealer.

If you have any questions about the operation, set up or maintenance of this machine please call our customer service department at 1 (800) 556-3113.

**THERE IS A RISK ASSUMED BY INDIVIDUALS WHO USE THIS TYPE OF EQUIPMENT. TO MINIMIZE RISK, YOU MUST FOLLOW THESE RULES:**

1. Inspect equipment before each workout. Check that all nuts, bolts, screws and pop pins are in place and fully tightened. Also, before use, check cables for signs of wear. Replace all worn parts immediately. Never use machine if any parts are damaged or missing.  
**FAILURE TO FOLLOW THESE RULES MAY RESULT IN SERIOUS INJURY.**
2. Keep clear of the cables and all moving parts when the machine is in use.
3. Always make sure all Snap Links are closed when doing any cable/pulley/strap exercises.
4. Exercise with care. Perform your exercises at a smooth moderate pace; never perform jerky or uncoordinated movements that may cause injury.
5. It is recommended that you should workout with a training partner.
6. Do not allow children or minors to play on or around this equipment.
7. If unsure of proper use of equipment, call your local Body-Solid distributor or the Body-Solid customer service department at 1-800-556-3113.
8. **WARNING:** Consult your physician before starting your exercise program. For your own safety, do not begin any exercise program without proper instruction. RAL8-6-03 WC-54

## Table of Contents

- SAFETY INSTRUCTIONS..... PAGE 4
- PREPARATION..... PAGE 5
- PART / HARDWARE LIST..... PAGE 6
- HARDWARE ILLUSTRATION..... PAGE 8
- ASSEMBLY INSTRUCTIONS.....PAGE 14
- EXPLODED VIEW..... PAGE 21
- CONTACT PAGE..... PAGE 22

# Important Safety Instructions

Before beginning any fitness program, you should obtain a complete physical examination from your physician.

*Il est conseillé de subir un examen médical complet avant d'entreprendre tout programme d'exercice.  
Si vous avez des étourdissements ou des faiblesses, arrêtez les exercices immédiatement.*

*Antes de comenzar cualquier programa de ejercicios, deberías tener un examen físico con su doctor.*

## **When using exercise equipment, you should always take basic precautions, including the following:**

- Read all instructions before using the **LVLC**. These instructions are written to ensure your safety and to protect the unit.
- **Do not remove any safety labels from the machine.**
- Do not allow children on or near the equipment.
- Use the equipment only for its intended purpose as described in this guide. Do not use accessory attachments that are not recommended by the manufacturer. Such attachments might cause injuries.
- Wear proper exercise clothing and shoes for your workout, no loose clothing.
- Keep hands, limbs, loose clothing, and long hair well out of the way of all moving parts.
- Use care when getting on or off the unit.
- Do not overexert yourself or work to exhaustion.
- If you feel any pain or abnormal symptoms, stop your workout immediately and consult your physician.
- Never operate unit when it has been dropped or damaged. Return the equipment to a service center for examination and repair.
- Never drop or insert objects into any opening in the equipment.
- Always check the unit and its cables before each use. Make sure that all fasteners and cables are secure and in good working condition.
- Do not use the equipment outdoors or near water.

## **Personal Safety During Assembly**

- Before beginning assembly, please take the time to read the instructions thoroughly.
- Read each step in the assembly instructions and follow the steps in sequence. Do not skip ahead. If you skip ahead, you may learn later that you have to disassemble components and that you may have damaged the equipment.
- Assemble and operate the **LVLC** on a solid, level surface. Locate the unit a few feet from the walls or furniture to provide easy access.

The **LVLC** is designed for your enjoyment. By following these precautions and using common sense, you will have many safe and pleasurable hours of healthful exercise with your **Body-Solid Leverage Leg Curl**.

After assembly, you should check all functions to ensure correct operation. If you experience problems, first recheck the assembly instructions to locate any possible errors made during assembly. If you are unable to correct the problem, call the dealer from whom you purchased the machine or call **1-800-556-3113** for the dealer nearest you.

## **Obtaining Service**

Please use this Owner's Manual to make sure that all parts have been included in your shipment. When ordering parts, you must use the part number and description from this Owner's Manual. Use only Body-Solid replacement parts when servicing this machine. Failure to do so will void your warranty and could result in personal injury.

For information about product operation or service, check out the official Body-Solid website at [www.bodysolid.com](http://www.bodysolid.com) or contact an authorized Body-Solid dealer or a Body-Solid factory-authorized service company or contact Body-Solid customer service at one of the following:

**Toll Free: 1-800-556-3113**  
**Phone: 1-708-427-3555**  
**Fax: 1-708-427-3556**  
**Hours: M-F 8:30-5:00 CST**  
**E-Mail: [service@bodysolid.com](mailto:service@bodysolid.com)**

**Or write to: Body-Solid, Inc.**  
**Service Department**  
**1900 S. Des Plaines Ave.**  
**Forest Park, IL 60130 USA**

**Retain this Owner's Manual for future reference. If you need to order replacement parts please be prepared to provide the following information when contacting us so that we can assist you better.**

- 1. Model Number**
- 2. Place of Purchase**
- 3. Serial Number (S/N)**
- 4. Part # and Description**

Thank you for purchasing the **LVLC**. This Product is part of the Body-Solid line of quality strength training machines, which lets you target specific muscle groups to achieve better muscle tone and overall body conditioning. To maximize your use of the equipment please study this Owner's Manual thoroughly.

### **Required Tools**

The basic tools that you must obtain before assembling the **LVLC** include but are not limited to:

- Standard Wrench Set
- Metric Wrench Set
- Adjustable Wrench

### **Installation Requirements**

Follow these installation requirements when assembling the **LVLC**:

Set up the **LVLC** on a solid, flat surface. A smooth, flat-surface under the machine helps keep it level. A level machine has fewer malfunctions.

Provide ample space around the machine. Open space around the machine allows for easier access.

Insert all bolts in the same direction. For aesthetic purposes, insert all bolts in the same direction unless specified (in text or illustrations) to do otherwise.

Leave room for adjustments. Tighten fasteners such as bolts, nuts, and screws so the unit is stable, but leave room for adjustments. Do not fully tighten fasteners until instructed in the assembly steps to do so.

**Fill out and mail the warranty card.**

### **Assembly Tips**

Read all "Notes" on each page before beginning each step.

While you may be able to assemble the **LVLC** using the illustrations only, important safety notes and other tips are included in the text.

Some pieces may have extra holes that you will not use. Use only those holes indicated in the instructions and illustrations.

**NOTE:** With so many assembled parts, proper alignment and adjustment is critical. While tightening the nuts and bolts, be sure to leave room for adjustments.

**CAUTION:** Obtain assistance! If you feel like you can't assemble the **LVLC** by yourself then do not attempt to do so as this could result in injury. Review the installation requirements before proceeding with the following steps.

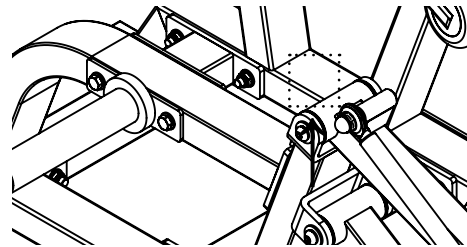

Your S/N# can  
be found here

Body-Solid continually seeks ways to improve the performance, specifications and product manuals in order to ensure that only superior products are released from our factories. Please take the time to carefully read through this manual thoroughly. Instructions contained in this document are not intended to cover all details or variations possible with Body-Solid equipment, or to cover every contingency that may be met in conjunction with installation, operation, maintenance or troubleshooting of the equipment. Even though we have prepared this manual with extreme care, neither the publisher nor the author can accept responsibility for any errors in, or omission from, the information given. Should additional information be required, or should situations arise that are not covered by this manual, the matter should be directed to your local Body-Solid representative, or the Service Department at Body-Solid Inc. in Forest Park, Illinois.

## LVLC Parts & Hardware List

<b>Part#</b>	<b>Qty</b>	<b>Description</b>
A	1	LEFT MAIN FRAME
B	1	FRONT MAIN FRAME
C	1	SUPPORT FRAME
D	1	RIGHT MAIN FRAME
E	2	LEFT HANDLE
F	1	CROSSMEMBER FRAME
G	1	UPPER LEVER ARM
H	1	ADJUSTMENT FRAME
J	1	LOWER LEVER ARM
K	1	WEIGHT HORN
L	1	SEAT BRACKET
M	1	ø25x495mm CHROME ROD
N	1	WEIGHT PLATE STORAGE
P	1	RIGHT HANDLE
1	8	M12x110mm HEX HEAD BOLT
2	4	M12x105mm HEX HEAD BOLT
3	4	M12x25mm BUTTON HEAD CAP SCREW
4	4	M12x20mm HEX HEAD BOLT
5	2	M10x100mm HEX HEAD BOLT
6	2	M10x25mm BUTTON HEAD CAP SCREW
7	1	M10x20mm SOCKET HEAD CAP SCREW
8	3	M8x75mm HEX HEAD BOLT
9	4	M8x30mm HEX HEAD BOLT
10	4	M5x10mm PHILLIPS FLAT HEAD SCREW
11	2	M4x8mm PHILLIPS FLAT HEAD SCREW
12	2	M16 LOCK WASHER
13	28	M12 WASHER
14	8	M12 LOCK WASHER
15	4	M12 LARGE WASHER
16	4	M10 WASHER
17	1	M10 LOCK WASHER
18	1	M10 LARGE WASHER
19	7	M8 WASHER
20	7	M8 LOCK WASHER

## LVLC Parts & Hardware List

<b>Part#</b>	<b>Qty</b>	<b>Description</b>
22	12	M12 NYLON LOCK NUT
23	2	M10 NYLON LOCK NUT
24	4	FOOT PAD
25	4	BEARING (NA4905)
26	4	ø51xø25.5mm WASHER
27	2	BALL JOINT ROD END (KGB SA16TK)
28	1	RUBBER BUMPER
29	2	RUBBER DONUT
30	2	ø20x120mm SHAFT
31	1	POP PIN
32	2	ø45xø25x28mm BUSHING
33	1	FOAM ROLLER
34	2	ADJUSTMENT BRACKET
35	1	PAD WRAP
36	1	BACK PAD
37	1	SEAT PAD
38	2	HANDLE END CAP
39	2	FOAM GRIP

# LVLC Hardware Illustration

Part #1

HEX HEAD BOLT M12x110mm

QTY. 8

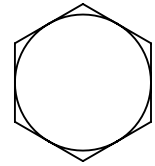
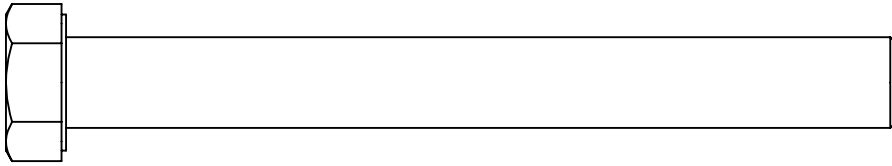

Part #2

HEX HEAD BOLT M12x105mm

QTY. 4

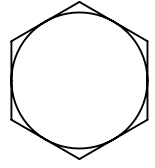
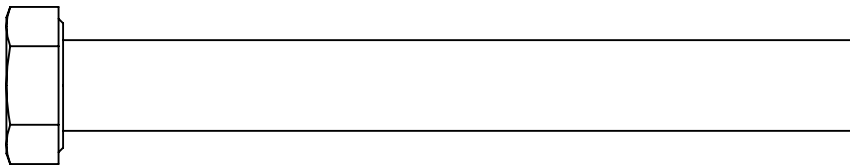

Part #3

BUTTON HEAD CAP SCREW M12x25mm

QTY. 4

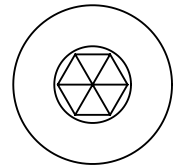
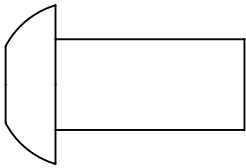

Part #4

HEX HEAD BOLT M12x20mm

QTY. 4

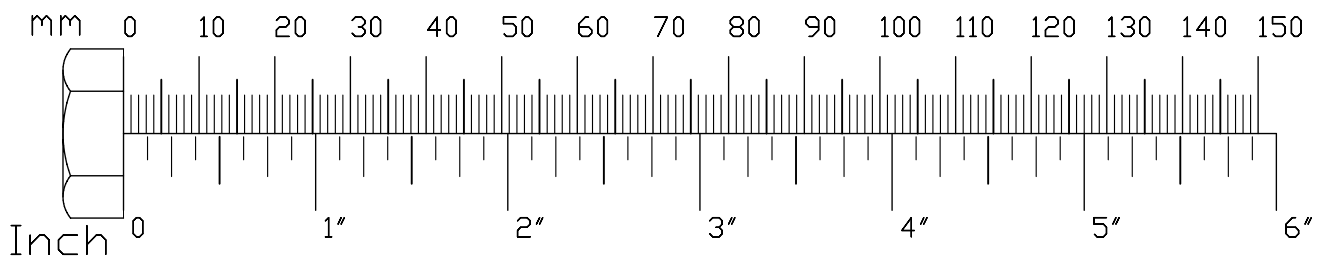
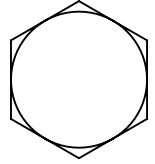
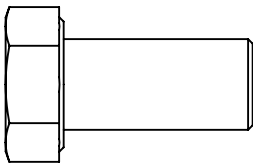



# LVLC Hardware Illustration

Part #5

HEX HEAD BOLT M10x100mm

QTY. 2

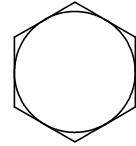
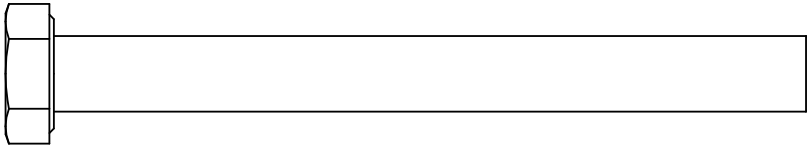

Part #6

BUTTON HEAD CAP SCREW M10x25mm

QTY. 2

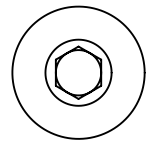
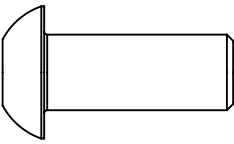

Part #7

SOCKET HEAD CAP SCREW M10x20mm

QTY. 1

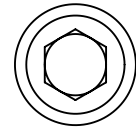
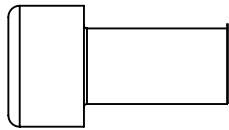

Part #8

HEX HEAD BOLT M8x75mm

QTY. 3

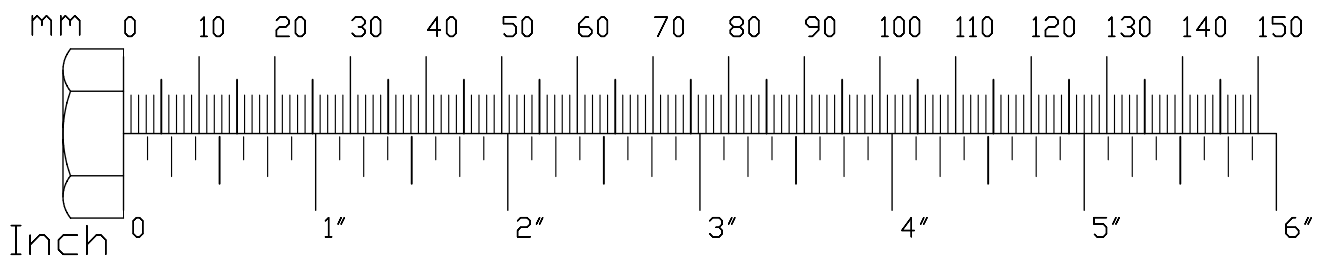
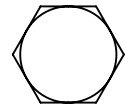
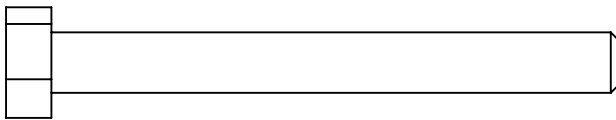

# LVLC Hardware Illustration

Part #9

HEX HEAD BOLT M8x30mm

QTY. 4

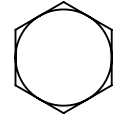
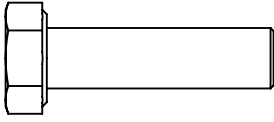

Part #10

PHILLIPS FLAT HEAD SCREW M5x6mm  
PRE-INSTALLED

QTY. 4



Part #11

PHILLIPS FLAT HEAD SCREW M4x8mm  
PRE-INSTALLED

QTY. 2



Part #12

WASHER M16

QTY. 4

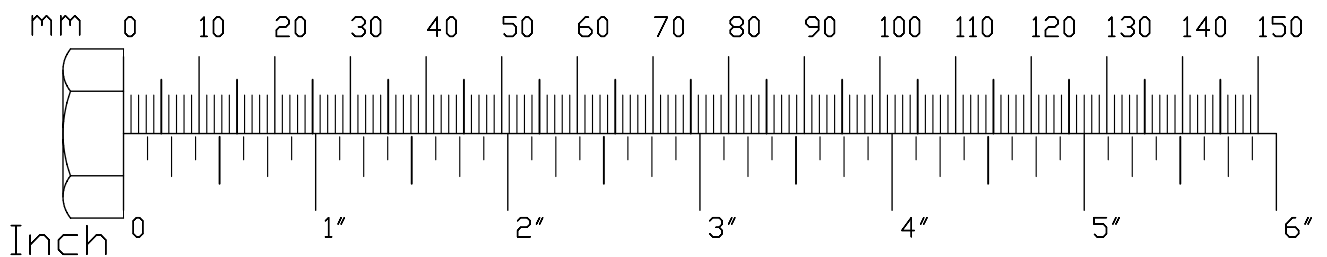
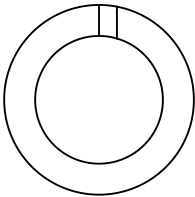

# LVLC Hardware Illustration

Part #13

WASHER M12

QTY. 28

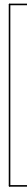
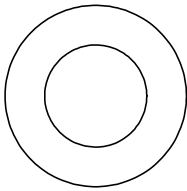

Part #14

LOCK WASHER M12

QTY. 8

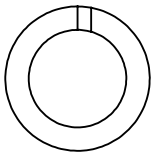

Part #15

LARGE WASHER M12

QTY. 4

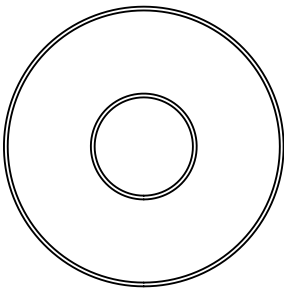

Part #16

WASHER M10

QTY. 4

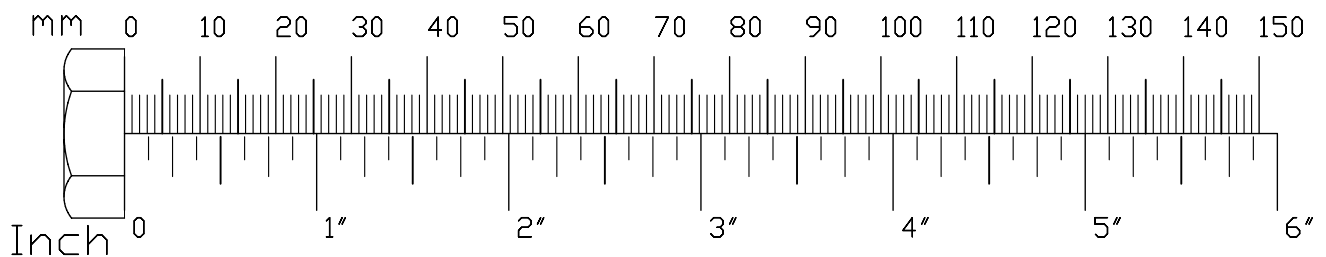
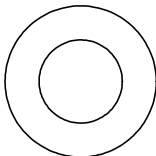

# LVLC Hardware Illustration

Part #17

LOCK WASHER M10

QTY. 1

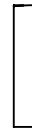
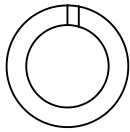

Part #18

LARGE WASHER M10

QTY. 1

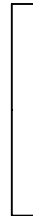
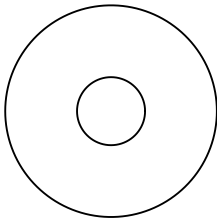

Part #19

WASHER M8

QTY. 7

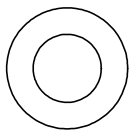

Part #20

LOCK WASHER M8

QTY. 7

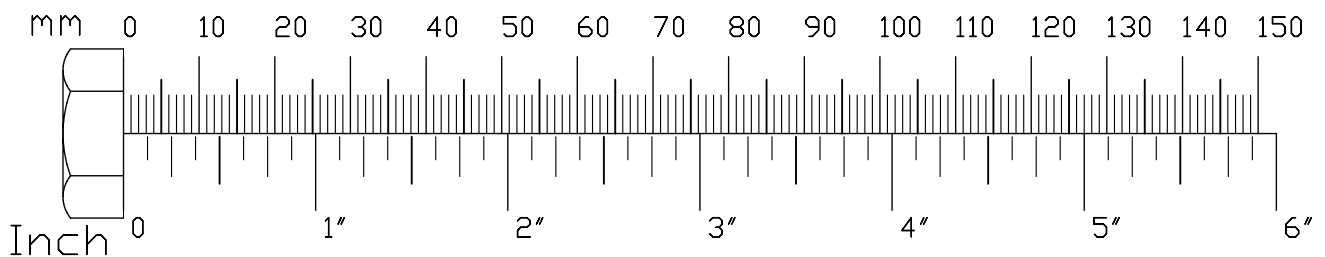
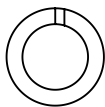

# LVLC Hardware Illustration

Part #21

ACORN NUT M16

QTY. 2

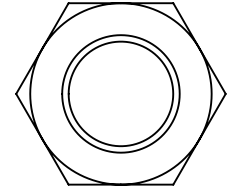
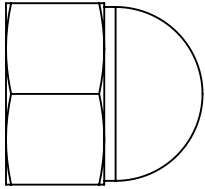

Part #22

NYLON LOCK NUT M12

QTY. 12

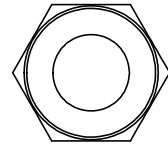
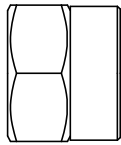

Part #23

NYLON LOCK NUT M10

QTY. 2

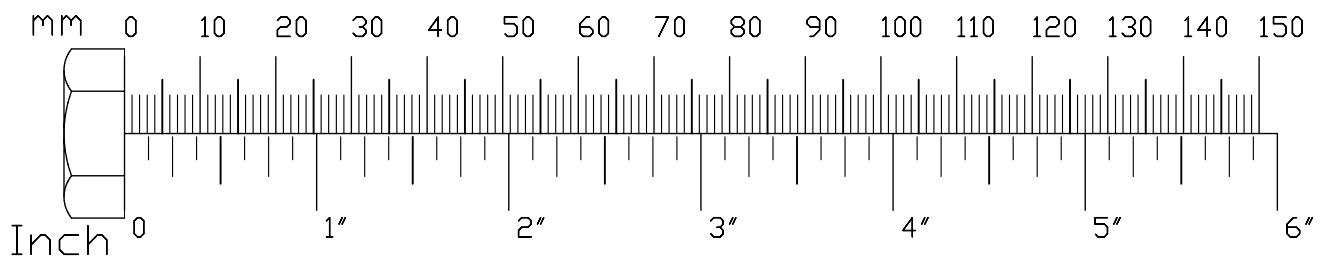
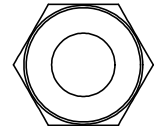
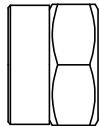

**STEP****1**

**Be careful to assemble all components in the sequence they are presented.**

**NOTE:**

**Wrench tighten ALL hardware at the end of STEP 1F. Some components may be pre-assembled. Nylon lock nuts will not fully screw onto bolts, they must be wrench tighten to fully go on.**

- 1A.** Attach Front Main Frame **(B)** to Right Main Frame **(D)** using:  
2 - **(#1)** M12x110mm Hex Head Bolt  
4 - **(#13)** M12 Washer  
2 - **(#22)** M12 Nylon Lock Nut
- 1B.** Attach Front, Left & Support Frames **(A, B & C)** together using:  
2 - **(#1)** M12x110mm Hex Head Bolt  
4 - **(#4)** M12x25mm Hex Head Bolt  
8 - **(#13)** M12 Washer  
4 - **(#14)** M12 Lock Washer  
2 - **(#21)** M12 Nylon Lock Nut
- 1C.** Attach Crossmember Frame **(F)** to Left Main Frame **(A)** using:  
2 - **(#1)** M12x110mm Hex Head Bolt  
4 - **(#13)** M12 Washer  
2 - **(#22)** M12 Nylon Lock Nut
- 1D.** Attach Crossmember Frame **(F)** to Right Main Frame **(D)** using:  
2 - **(#1)** M12x110mm Hex Head Bolt  
4 - **(#13)** M12 Washer  
2 - **(#22)** M12 Nylon Lock Nut
- 1E.** Attach Foot Pads **(#24)** to Main Frames **(A, B & D)**.
- 1F.** Attach Rubber Bumper **(#28)** to Left Main Frame **(A)** using:  
1 - **(#7)** M10x20mm Socket Head Cap Screw

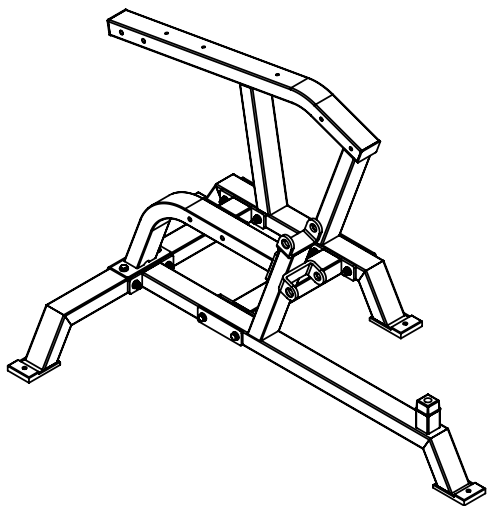

Above shows Step 1 assembled and completed.

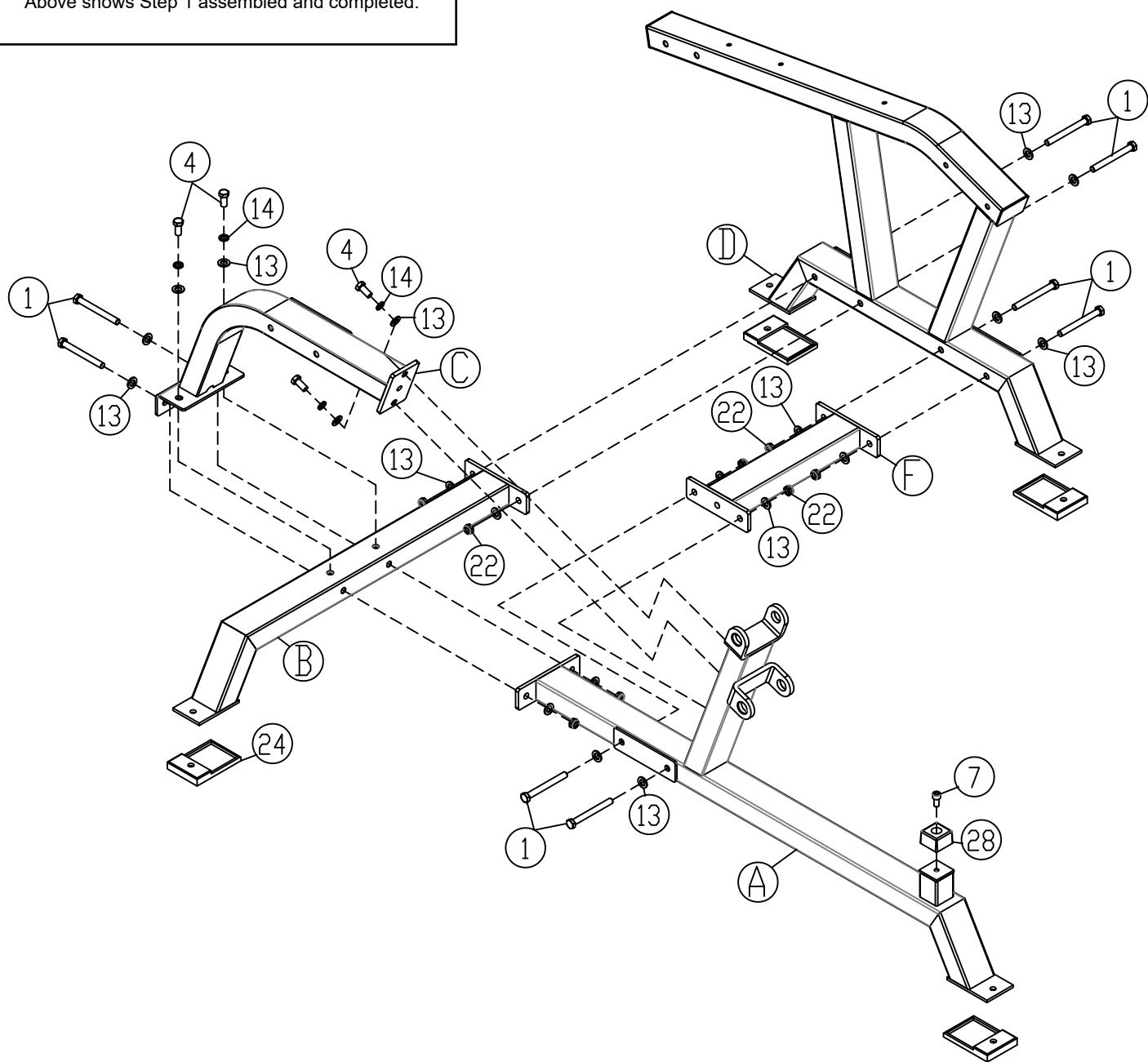

**STEP****2**

**Be careful to assemble all components in the sequence they are presented.**

**NOTE:**

**Wrench tighten ALL hardware at the end of STEP 2F. Some components may be pre-assembled. Nylon lock nuts will not fully screw onto bolts, they must be wrench tighten to fully go on.**

- 2A.** Attach Upper Lever Arms (**G**) to Left Main Frame (**A**) using:
- 2 - (#3) M12x25mm Button Head Cap Screw
  - 2 - (#15) M12 Large Washer
  - 2 - (#14) M12 Lock Washer
  - 2 - (#26)  $\varnothing 51 \times \varnothing 25.5$ mm Washer
  - 1 - (#30) Shaft
- 2B.** Attach Lower Lever Arms (**J**) to Left Main Frame (**A**) using:
- 2 - (#3) M12x25mm Button Head Cap Screw
  - 2 - (#15) M12 Large Washer
  - 2 - (#14) M12 Lock Washer
  - 2 - (#26)  $\varnothing 51 \times \varnothing 25.5$ mm Washer
  - 1 - (#30) Shaft
- 2C.** Attach Weight Horn (**K**) to Lower Lever Arms (**J**).
- 2D.** Attach Weight Plate Storage (**N**) to Support Frame (**C**).
- 2E.** Insert Rubber Donuts (**#29**) onto Weight Horn (**J**) and Weight Plate Storage (**N**).
- 2F.** Attach Left & Right Handles (**E & P**) to Right Main Frame (**D**) using:
- 2 - (#2) M12x105mm Hex Head Bolt
  - 4 - (#13) M12 Washer
  - 2 - (#22) M12 Nylon Lock Nut



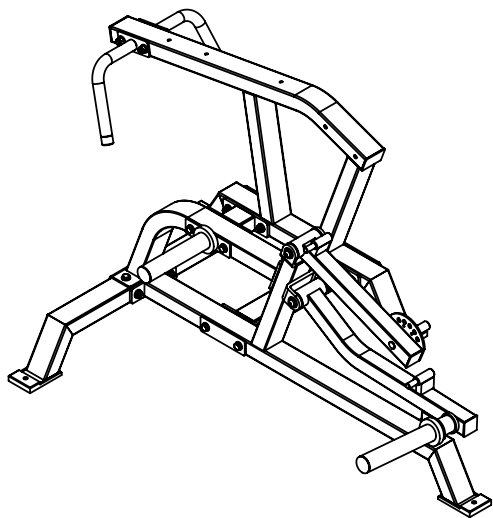

Above shows Step 2 assembled and completed.

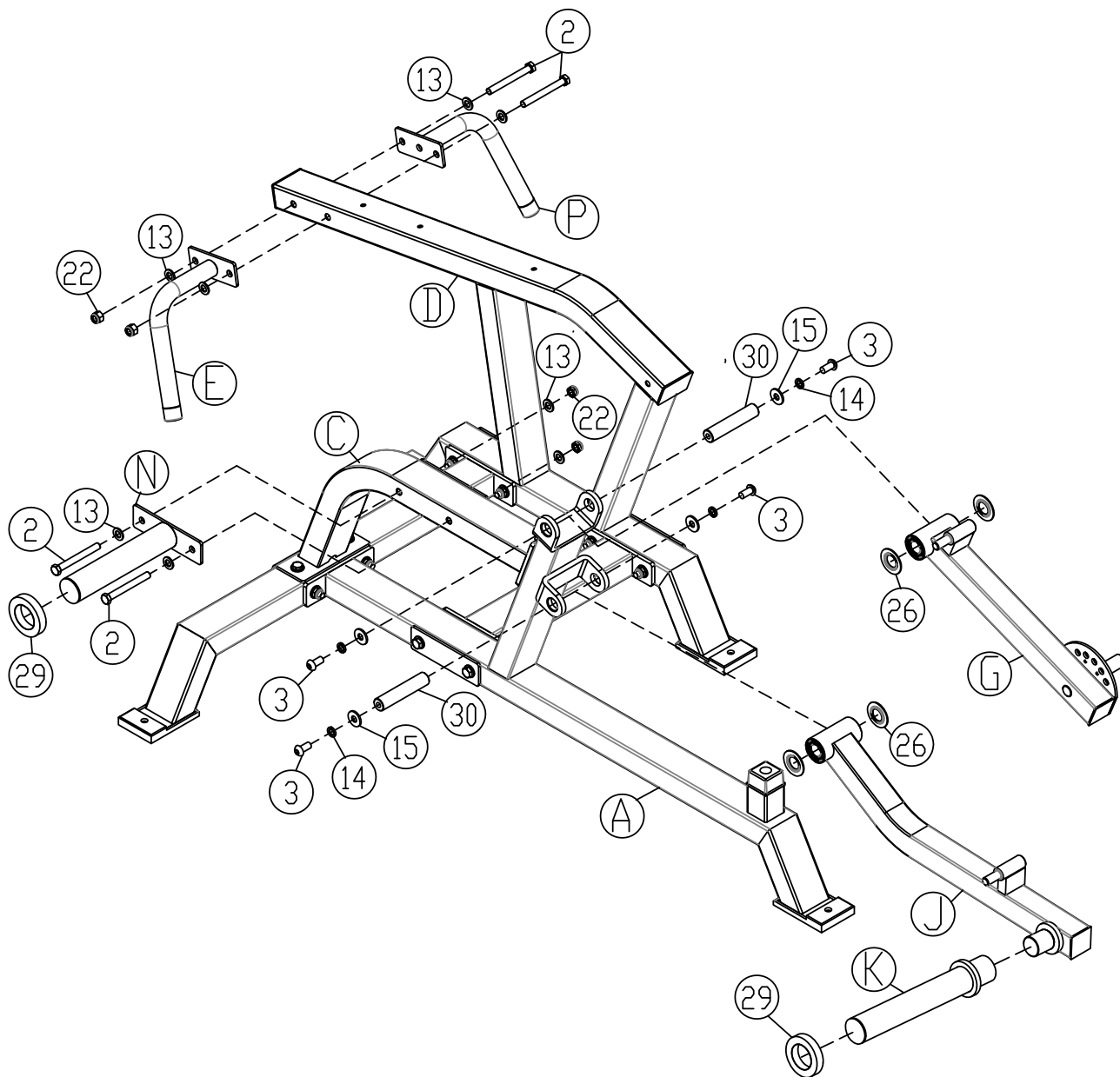

**STEP****3**

**Be careful to assemble all components in the sequence they are presented.**

**NOTE:**

**Wrench tighten ALL hardware at the end of STEP 3F. Some components may be pre-assembled. Nylon lock nuts will not fully screw onto bolts, they must be wrench tighten to fully go on.**

- 3A.** Attach Chrome Rods (**M**) to Lever Arms (**J & G**) using:  
2 - (#12) M16 Lock Washer  
2 - (#21) M16 Acorn Nut
- 3B.** Attach Adjustment Frame (**H**) to Upper Lever Arm (**G**) using:  
1 - (#6) M10x25mm Button Head Cap Screw  
1 - (#17) M10 Lock Washer  
1 - (#18) M10 Large Washer
- 3C.** Attach Back Pad (**#36**) to Right Main Frame (**D**) using:  
3 - (#8) M8x75mm Hex Head Bolt  
3 - (#19) M8 Washer  
3 - (#20) M8 Lock Washer
- 3D.** Attach Seat Bracket (**L**) to Right Main Frame (**D**) using:  
2 - (#5) M10x100mm Hex Head Bolt  
4 - (#16) M10 Washer  
2 - (#23) M10 Nylon Lock Nut
- 3E.** Attach Seat Pad (**#37**) to Seat Bracket (**L**) using:  
4 - (#9) M8x30mm Hex Head Bolt  
4 - (#19) M8 Washer  
4 - (#20) M8 Lock Washer
- 3F.** Attach Foam Roller (**#33**) to Adjustment Frame (**H**) using:  
1 - (#6) M10x25mm Button Head Cap Screw



# Notes

# LVLC Exploded View

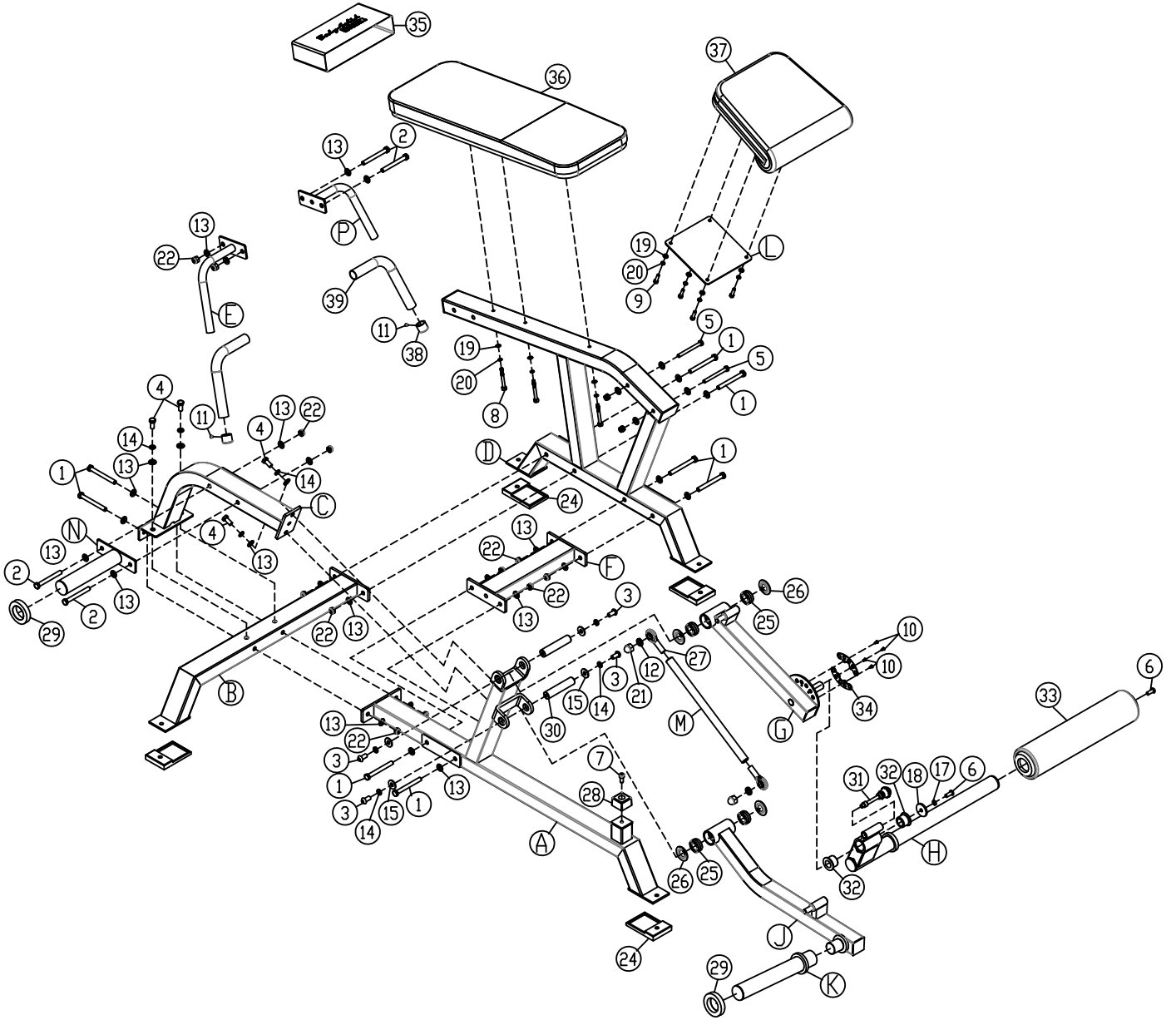



# LVLC

PLEASE WRITE YOUR SERIAL NUMBER IN THE BOXES BELOW

S/N # 001930----

1900 S. Des Plaines Ave.  
Forest Park, IL 60130  
Phone:(708)427-3555  
Fax:(708)427-3556  
Hours: M-F 8:30 - 5:00 CST

*[www.bodysolid.com](http://www.bodysolid.com)*