

QUICK SWITCH BLUETOOTH KEYBOARD FOR THREE DEVICES

User's Guide



For Three Devices - Mac, iPad/Pro and iPhone

Table of Contents

Introduction	1
Package Contents	1
System Requirements / Technical Support	1
Macally Product Information	1
Hardware Basics	3
Fn Key, Fn Lock Mode and Shortcuts	4
Pairing the keyboard with Mac	6
Pairing the keyboard with iPhone/iPad	10

Introduction

The Macally BTWKEY is a stylish Bluetooth wireless keyboard with a brushed stainless steel finish and concave keypad design, especially designed for Mac. Easy to pair with any Mac, iPad and iPhone, this keyboard offers a stable and reliable Bluetooth wireless connection, and a cable-free and clean workspace. This keyboard supports up to three Bluetooth macOS and iOS devices. One-touch quick switch allows you to switch easily between your Mac, iPad and/or iPhone. It has 110 full size, thin and quiet Scissor-Key-Switch™ keycaps with a concave design for a sensitive and responsive touch. It also has 21 convenient preset shortcut keys and a 17-key numeric keypad to quickly and efficiently enter long sequences of numbers. With this keyboard you don't need to buy and replace batteries as it has built-in 650 mAh rechargeable Li-ion battery that lasts over 2 months*. It has an On/Off switch to save battery life. The keyboard turns off automatically when not in use for more than 10 minutes to save battery life. Stylish and slim keyboard with a brushed metal finish and concave design keycaps, it's specially designed for any Apple computer equipped with Bluetooth and Mac OS X v10.6 and above, and any iPad and iPhone with iOS 5.0 and above. Whether it is doing work with a computer, sending messages on a smartphone, or enjoying videos on a tablet, it is truly the only keyboard that you need for all your applications.

Before you begin using this product, be sure to read this user's guide in its entirety.

Package Contents

- BTWKEYMB Bluetooth Keyboard
- USB charging cable
- User's Guide

System Requirements

- Any Mac computer with a Bluetooth host
- Mac OS X v10.6 and above
- iPhone, iPad/Pro and iPad mini
- iOS 5.0 and above

Macally Product Information

Technical Support

Please E-mail us at techsupport@macally.com, or call us at 1-909-230-6888 Monday to Friday, 8:30AM to 5:30PM, Pacific Standard Time

FAQ & help - <https://help.macally.com/help>

Manual and driver download -

<https://us.macally.com/pages/drivers-and-downloads>

Macally Product Information

This manual is furnished under license and may be used or copied only in accordance with the terms of such license.

Except as permitted by such license, no part of this publication may be reproduced, stored in a retrieval system, or transmitted, in any form or any means, electronic, mechanical, recording, or otherwise, including translation to another language or format, without the prior written permission of Macally Peripherals.

The content of this manual is furnished for informational use only, is subject to change without notice, and should not be construed as a commitment by Macally Peripherals. Macally Peripherals assumes no responsibility or liability for any errors or inaccuracies that may appear in this book.

Macally is a trademark of the Mace Group, Inc. All other product names, trademarks and registered trademarks in this document are the property of their respective holder.

Copyright® 2019 by Macally Peripherals

FCC Information

This device complies with part 15 of the FCC Rules. Operation is subject to the following two conditions: (1) this device may not cause harmful interference and (2) this device must accept any interference received, including interference that may cause undesired operation.

Warranty

Macally peripherals warrants that this product will be free from defects in title, materials and manufacturing workmanship for two years from the date of purchase. If the product is found to be defective then, as your sole remedy and as the manufacturer's only obligation, Macally will repair or replace the product. This warranty shall not apply to products that have been subject to abuse, misuse, abnormal electrical or environmental conditions, or any condition other than what can be considered as normal use.

Warranty Disclaimers

Macally Peripherals makes no other warranties, express, implied or otherwise, regarding the BTkey, and specifically disclaims any warranty for merchantability or fitness for a particular purpose. The exclusion of implied warranties is not permitted in some states and the exclusions specified herein may not apply to you. This warranty provides you with specific legal rights. There may be other rights that you have which vary from state to state.

Limitation of Liability

The liability of Macally Peripherals arising from this warranty and sale shall be limited to a refund of the purchase price. In no event shall Macally Peripherals be liable for costs of procurement of substitute products or services, or for any lost profits, or for any consequential, incidental, direct or indirect damages, however caused and on any theory of liability, arising from this warranty and sale. These limitations shall apply notwithstanding any failure of essential purpose of any limited remedy. V1.1.

Hardware Basics

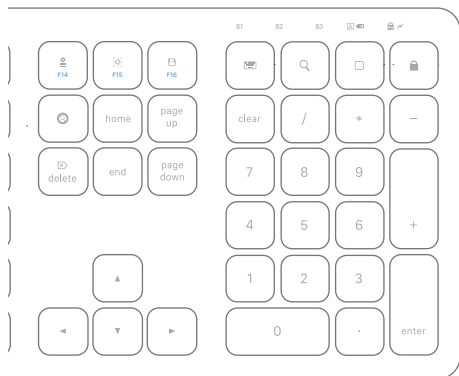
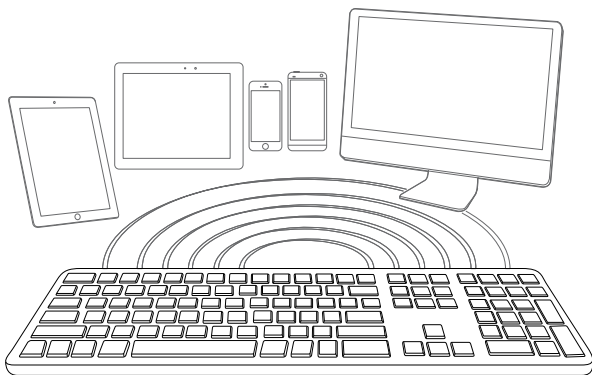

To USB port of a
charger or computer

USB charging
cable
(included)

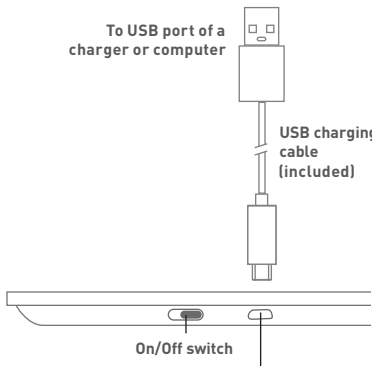

Charging Port

- 1 On/Off switch
- 2 Light during charging:
red - charging; off - full
Fn lock: blue
- 3 Caps lock: blue
Low battery: light flashing
- 4 Device 3 Indicator
- 5 Device 2 indicator
- 6 Device 1 indicator
- 7 Pairing Keys: Press Fn and P simultaneously

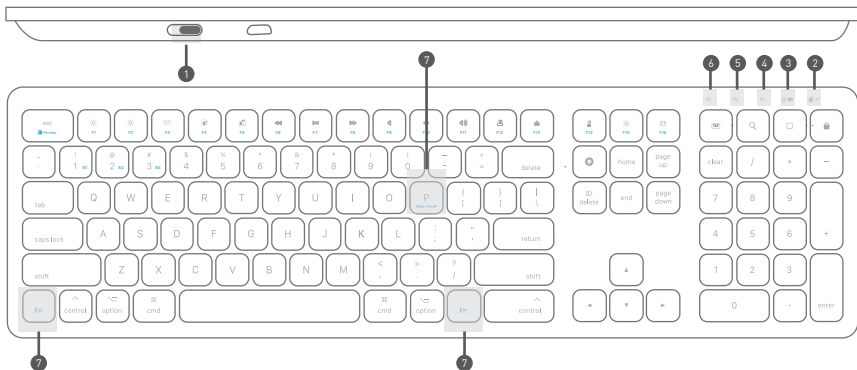

Fn Key, Fn Lock Mode and Shortcuts

Use of Fn key: Select Bluetooth device, Pair with a device and use blue color keys















1. Press Fn with one of Bluetooth device keys, B1, B2 and B3 to select a Bluetooth device to use the keyboard
2. The first time using with a Bluetooth device, pairing is needed. After selecting a device, press Fn and P keys simultaneously, the device LED will flash quickly indicating the keyboard is in pairing mode.

Fn Lock Mode

Press Fn and esc keys simultaneously to lock in Fn mode, so blue colored Function keys are default when pressed, Fn lock LED is turned on to indicate the Fn Lock mode.

Shortcut Mode and Keys

List of shortcut keys and what systems are supported. ✓ means “supported”, blank means “not supported”

shortcuts	Function	Mac OSX	iOS	shortcuts	Function	Mac OSX	iOS
esc	esc	✓			Volume Up	✓	✓
	screen brightness down or up	✓	✓		Media Eject	✓	
	Mission Control	✓			Printer	✓	
	Copy	✓	✓		Area Capture	✓	✓
	Paste	✓	✓		Force Quit Application	✓	
⏮	Previous Track	✓	✓		File Save	✓	
⏸	Play/Pause	✓	✓		On-screen keyboard		✓
⏭	Next Track	✓	✓		Search	✓	✓
⏪	Mute	✓	✓		Home button		✓
⏩	Volume Down	✓	✓		Lock		✓

Please note, these shortcuts are not universal. Certain shortcuts such as Search, and Home may not work on MacOSX because they are meant to be used on iPad or iPhone. On the other hand, some shortcuts may act completely different on different devices so you should try them out first.

More about mode

In either Shortcut mode or Fn Lock mode, one can also press Fn key with one of top row key simultaneously to perform the secondary function without switching mode.

Important Note:

1. The keyboard has a built-in energy saving feature. It goes into sleep mode when not in use for a period of time. Press any key [such as “space” key] on your keyboard to wake up again.
2. Please wait for BTWKEY to be connected before entering your user’s password during computer boot up.
3. Pairing light needs to be on and flashing during pairing process. If it’s not flashing quickly, press Fn and P again and start all over to pair BTWKEY with your device.

Pairing the keyboard with Mac

1. After a Bluetooth device(for Mac) is selected, for the first time use, pairing is required. Make sure the keyboard is on and fully charged. Press Fn and P keys simultaneously to set keyboard in pairing mode, the device LED flashes blue quickly.

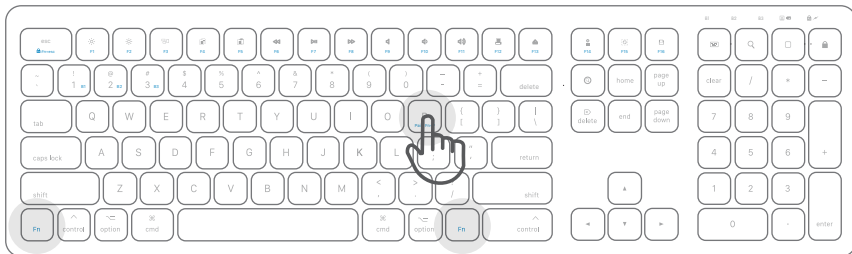

2. Please click the Bluetooth icon in your computer's menu bar located in upper right corner of your screen. Make sure Bluetooth is turned to On then select "Open Bluetooth Preferences ..." in the drop down menu.



3. From the Bluetooth screen, wait for the Macally Bluetooth Keyboard to show up then click on "Pair" or "connect" to add it.
NOTE: It may take up to a minute for the device to show up on the screen

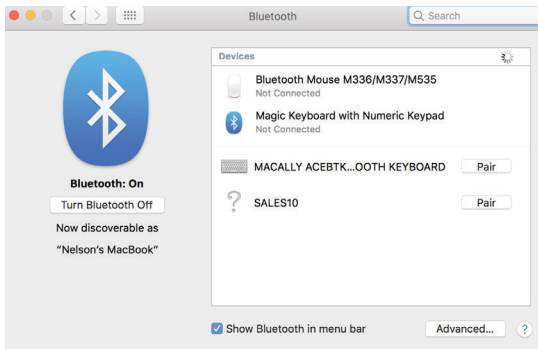

- 4: Once pairing is completed the Bluetooth keyboard will show "Connected". If you are having issues connecting, try turning Bluetooth in your Mac off then turn on and try re-pairing the keyboard again.

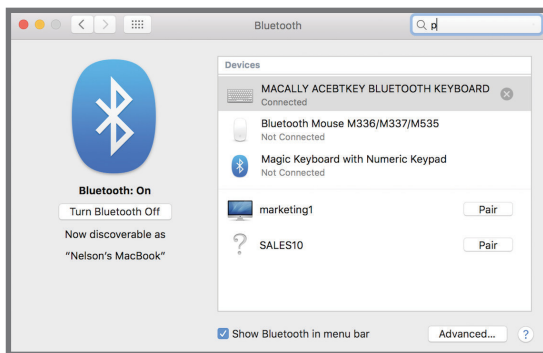

5. When Mac prompts you a message, "The keyboard can not be identified..." please follow Keyboard Setup Assistant guide to identify keyboard as shown below.

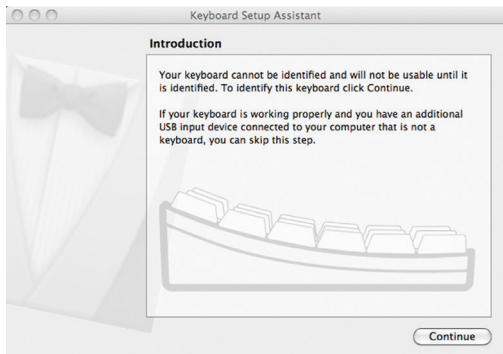

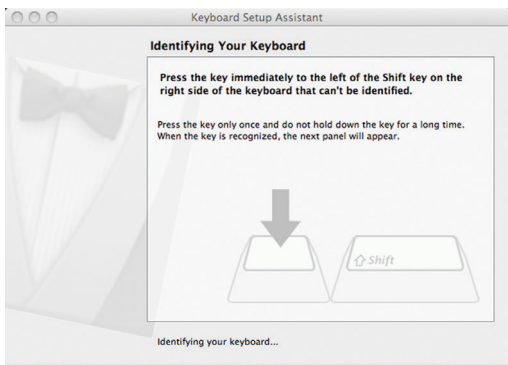

6. Select ANSI option, and click on Done button.

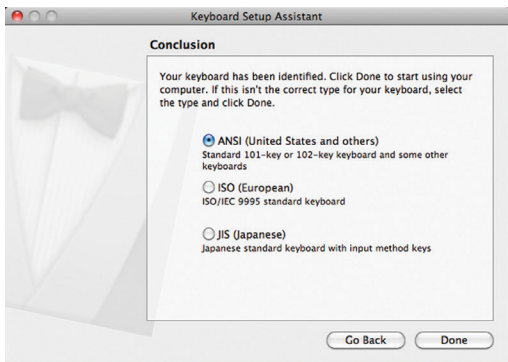

Please note that if you are using a different Apple OSX version, your screen may differ from the above diagrams.

Pairing the keyboard with iPad/iPhone

1. After a Bluetooth device(for iPad or iPhone) is selected, for the first time use, pairing is required. Make sure the keyboard is on and fully charged. Press Fn and P keys simultaneously to set keyboard in pairing mode, the device LED flashes blue quickly.
2. Bring your iPad or iPhone near by the keyboard. Open up “setting” then Bluetooth”.

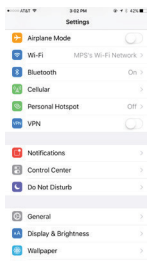

3. Turn on Bluetooth, under the “Bluetooth” menu, it will auto search for the new Bluetooth devices....

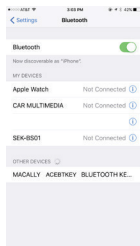

- Once it finds and displays MacallyBluetoothKeyboard or similar name, select it to pair with Macally Bluetooth Keyboard.
- After pairing is successfully completed, it will show "Macally Bluetooth Keyboard.... connected". It is ready to be used with your iPad or iPhone.

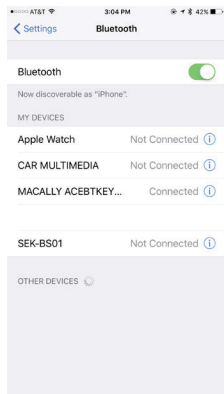

Please note that if you are using a different iOS version, your screen may differ from the above diagrams.

www.macally.com