



## COREnine 8835 MASSAGE CHAIR

Thank you for purchasing the 8835 Massage Chair. Please read the contents of this manual before using your chair and refer to it when needed.

## TECHNICAL SPECIFICATIONS

Model Name/Number: COREnine 8835 Massage Chair

Rated Voltage: 110v

Rated Power: 50/60 Hz

Net Weight: 180 lbs Weight Capacity: 285 lbs

© 2024 COREnine

The images in this manual are for reference purposes and may not resemble the massage chair design you purchased. COREnine reserves the right to make changes to the information in this document, including and without limitation the specifications and product descriptions at any time and without notice. No medical claims are warranted or implied by the use of this product.

## WARRANTY

COREnine's 8835 Massage Chair has a 2 year parts and 2 year in-home/in-shop service warranty.

To activate your massage chair warranty go to [corenineusa.com](http://corenineusa.com) > Support > Product Registration.

A 5 year extended warranty can be purchased on our website at [corenineusa.com](http://corenineusa.com) > Support > Warranties > Learn about our 5-Year Extended Warranty (box).

To view and download warranty information go to [corenineusa.com](http://corenineusa.com) > Support > Warranties.

## CONTENTS

PRODUCT AND ACCESSORIES .....	1
CHAIR REQUIREMENTS .....	2-3
SAFETY & MEDICAL PRECAUTIONS .....	4-6
MOVING THE CHAIR .....	7
CHAIR INSTALLATION .....	8-9
REMOTE CONTROL INSTRUCTIONS .....	10-11
ARM CONTROL INSTRUCTIONS .....	12
VOICE COMMAND/BLUETOOTH .....	13
CLEANING INSTRUCTIONS .....	14
REPLACING A FUSE .....	15
STORING THE CHAIR .....	15
TROUBLESHOOTING .....	16

## PRODUCT/ACCESSORIES

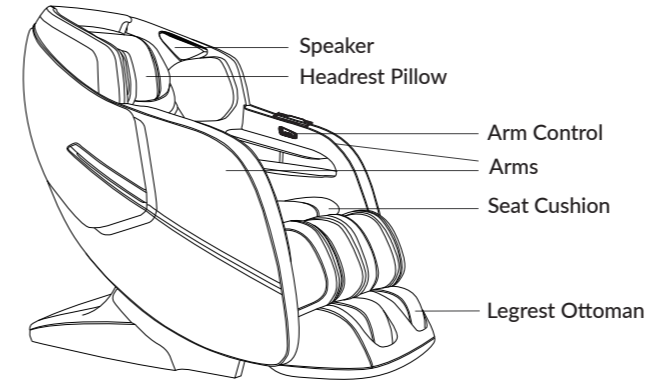

### MASSAGE CHAIR

Includes remote control, two arms, headrest pillow, seat cushion, and legrest ottoman.



### POWER CORD



### QUICK START GUIDE

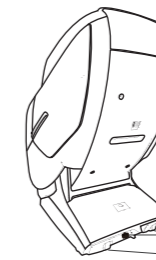

Power Switch  
Casters

## CHAIR REQUIREMENTS

### WALL CLEARANCE

When the massage chair is fully reclined it requires 3.5 inches of space behind it and 8 inches of space in front of it. Place the chair at least 40 inches away from audio and video devices (e.g. TV, radio) to prevent signal interference.

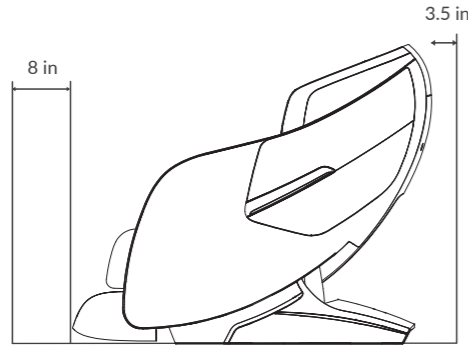

#### CAUTION

- Check to make sure the power cord is not knotted, entangled with any objects, or crushed under the massage chair.
- Keep children and pets away from the chair as it reclines and returns to the upright position.
- Make sure the chair is in the upright position before sitting down.



### SURROUNDING ENVIRONMENT

- Do not place this chair in direct sunlight or near an open flame or high temperature sources.
- Do not place this chair near damp or moist areas such as swimming pools or bathrooms.

## CHAIR REQUIREMENTS

### GROUNDING PRECAUTIONS



#### DANGER: To reduce the risk of electric shock

**WARNING!** An improper connection of the equipment-grounding conductor can result in a risk of electric shock. This chair must be connected to a properly grounded outlet. Grounding provides a path of least resistance for electrical current to reduce the risk of electric shock if the product malfunctions or breaks down. This chair is equipped with a cord having an equipment-grounding conductor and a grounding plug. If you are in doubt as to whether this product is properly grounded, do not modify the plug provided with this chair. Contact a qualified electrician to install a proper outlet.

- The electric cord must be plugged into an appropriate outlet that is properly installed and grounded in accordance with all local codes and ordinances.
- The chair must be connected to an outlet having the same configuration as the plug.
- No adapter should be used with this chair.
- Always unplug this chair from the electrical outlet immediately after using and before cleaning.



#### WARNING

Make sure the chair is fully assembled with the legrest on the floor before plugging the chair into an electrical outlet.

### POWERING UP THE CHAIR



Plug the power cord into an electrical outlet, and press the power button (located on the back of the chair) to the ON position. Next, press the power button on the remote control.

## IMPORTANT SAFETY PRECAUTIONS

Please read all of these instructions before using your massage chair.

### SAFETY WARNINGS

#### DANGER

- This massage chair should only be used for its intended purpose as described in this manual.
- To disconnect, turn all controls to the OFF position before unplugging the chair.
- NEVER attempt to repair or modify any electrical or mechanical functions in this chair.
- NEVER operate this chair if it has a damaged power cord or plug, if it is not working properly, if it has been dropped or damaged, or dropped into water.
- Do not place the power cord near heated surfaces, under heavy objects, or in high traffic areas.
- Do not remove the plug from the outlet while the chair is operating.
- Do not use the chair if the electrical outlet is loose.
- To avoid electric shock, NEVER use wet hands to connect or disconnect the power plug from the electrical outlet, and never use the massage chair when your body is wet or damp.
- If you spill liquid onto the chair, immediately turn off the chair and unplug the power cord.
- Do not operate this chair where flammable products are being used such as aerosol sprays or oxygen.
- Do not put hands or fingers near the rollers when the massage mechanism is operating. Injury may result from rollers squeezing together.
- Always confirm that there are no obstacles behind the chair and that there is sufficient space to recline.
- Keep children and pets away from the chair when in use.
- Close supervision is necessary when this chair is used by, on, or near children, invalids, or disabled persons.
- Do not operate this chair under a blanket or pillow. Excessive heating can occur and cause fire, electric shock, or injury.

## IMPORTANT SAFETY PRECAUTIONS

Please read all of these instructions before using your massage chair.

### SAFETY WARNINGS

#### DANGER

- Do not use the chair if it is damaged or if the covering shows any sign of deterioration, such as peeling or cracking, or if the fabric is torn or the internal components exposed.
- Do not use any attachments that are not included with this chair.
- Never drop or insert any object into any opening.
- Do not place or use this chair outdoors.
- When using this chair after it has been in storage, check to see that it is operating properly prior to use.
- Do not stand on the massage chair or the legrest ottoman. Use only while seated.

### MEDICAL PRECAUTIONS

#### WARNING

- DO NOT USE THIS CHAIR if you have a pacemaker or other medical electronic devices inside your body.
- Do not use this chair without consulting your physician if you have a medical condition.
- This chair is not intended for self-treatment of medical conditions that should be managed by a qualified health care provider.
- Do not massage any area of the body that is swollen, inflamed, or has skin eruptions.
- Do not use on unexplained leg or calf pain, or if you've been diagnosed with deep vein thrombosis.
- If you feel any abnormal discomfort while using the chair, stop use and consult your physician.

## IMPORTANT SAFETY PRECAUTIONS

### PROHIBITED ACTION THAT MAY VOID WARRANTY

#### CAUTION

- Any modification, disassembly, maintenance, or repair of the chair by anyone other than an approved service professional will void the warranty. Contact your retail provider if your chair is in need of service.
- Do not use any attachments that are not included with this massage chair.
- Do not remove the seat cushion or tamper with the massage mechanism.
- Do not allow children or pets to play near the chair during operation.
- Only one person at a time should use the massage chair. The maximum weight load for this chair is 285 lbs.
- Do not use this chair outdoors or in excessively hot, humid or dusty environments.
- Do not place this chair directly in the sun or near an open flame.
- Do not place this chair near damp or moist areas such as swimming pools or bathrooms.
- Do not place heavy objects on the chair.
- Do not stand on the massage chair. Use only while seated.
- Do not stand or sit on the armrest or legrest.
- Do not exert force on the massage rollers when the massage mechanism is operating.
- Do not operate under a blanket, pillow or electric blanket.
- Do not use this chair while smoking.
- This massage chair is only intended for personal in-home use. Commercial use will void warranty.

#### CAUTION

The wear and tear of the legrest footwells results from users leaving their shoes on, and this is NOT COVERED BY THE WARRANTY.

## MOVING THE MASSAGE CHAIR

The massage chair can be moved by raising the front of the chair and tilting back on the wheels.

- Unplug and remove the power cord and remote control before moving the chair.
- Use caution when handling the armrests and legrest ottoman to avoid damage.
- Use caution when rolling the chair across a tile or wood floor.
- To prevent the floor from being scratched, it is recommended that you place a towel or blanket under the wheels or lift the chair using at least two people.
- The chair should be placed on a flat level surface and away from damp rooms (i.e. bathrooms) and open flames (e.g. stove, fireplace).
- It is recommended that you place a soft mat underneath the chair to protect your floors.

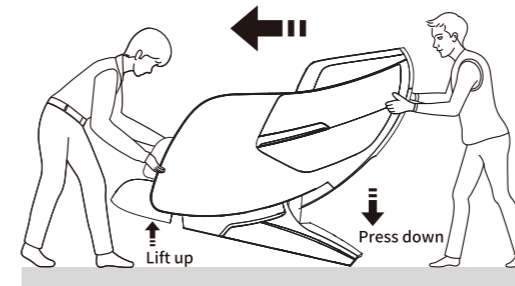

## CHAIR INSTALLATION

- 1 Manually lower the legrest.

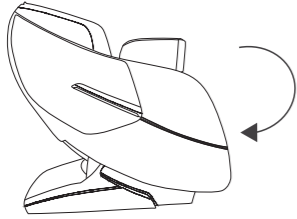

- 2 Remove all the fabric velcro protectors on the chair. Velcro the back and seat cushion in place.

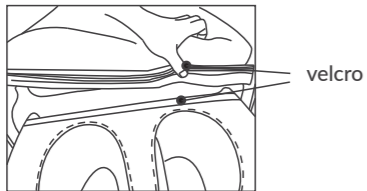

- 3 Uncover the backrest cover and connect the backrest cover to the heating wire on the seat.

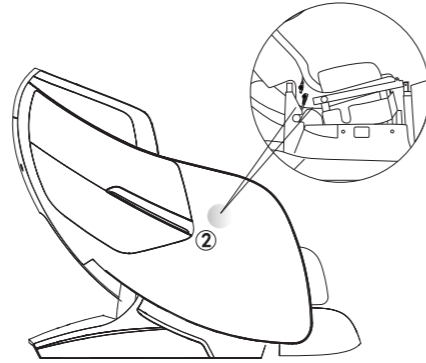

## CHAIR INSTALLATION

- 4 Attach the top of the back cushion with the zipper.

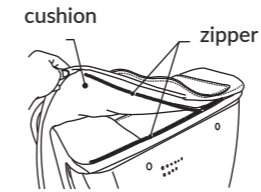

- 5 Connect the remote control wires and secure with the threaded nut. Align the interior groove patterns and connect both ends of the remote control cable.

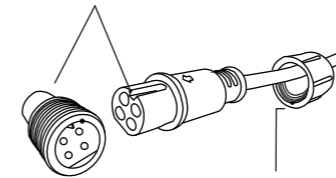

Secure with the plastic thread cap.

- 6 Connect the power cord to the chair's main power socket and plug into a power outlet. Turn the power switch to the "On" position.

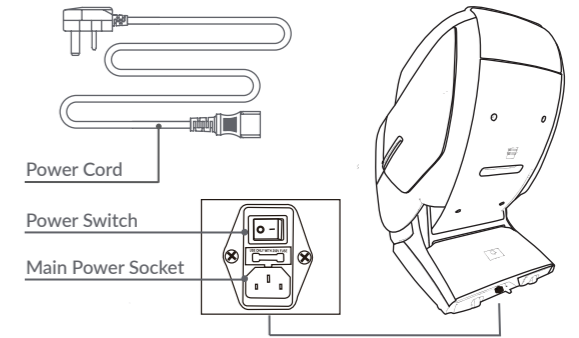

## REMOTE CONTROL

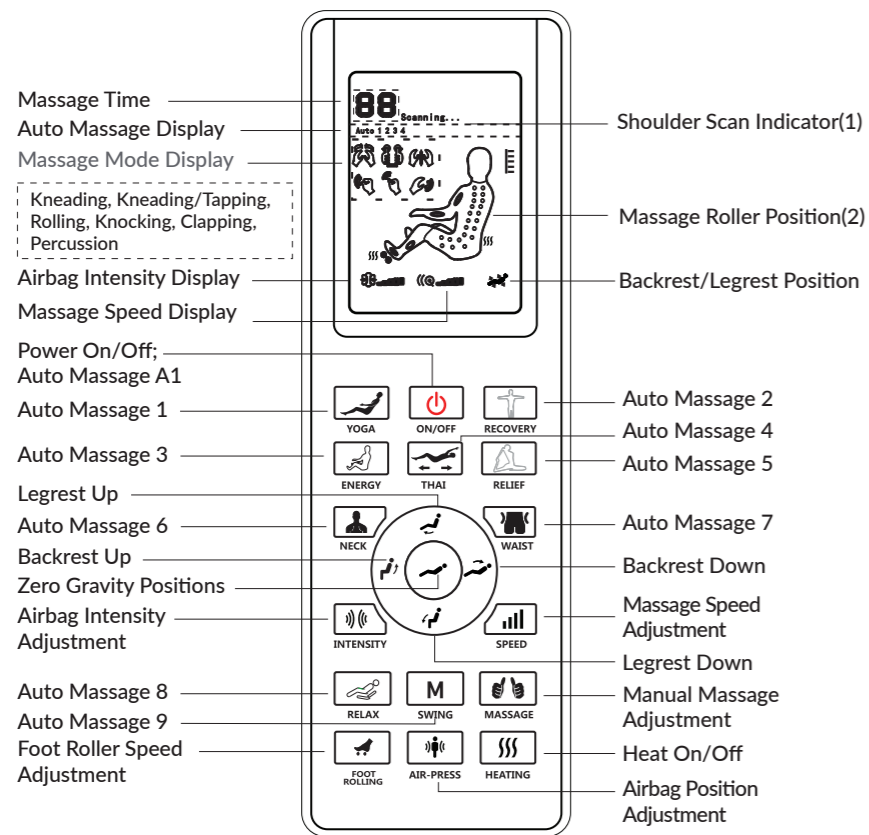

### PLEASE NOTE

**Shoulder Scan Indicator:**  
Wait until the scanning lights disappear before choosing an auto or manual massage. Auto Massage A1: Full Back Mode will automatically begin when the auto scan detection is complete.

**Message Roller Position:**  
Red areas indicate the current massage roller position.

### IMPORTANT NOTE

When the massage is complete, or if the massage has timed out, press the center (zero gravity) button to return the chair to its upright position.

## REMOTE CONTROL

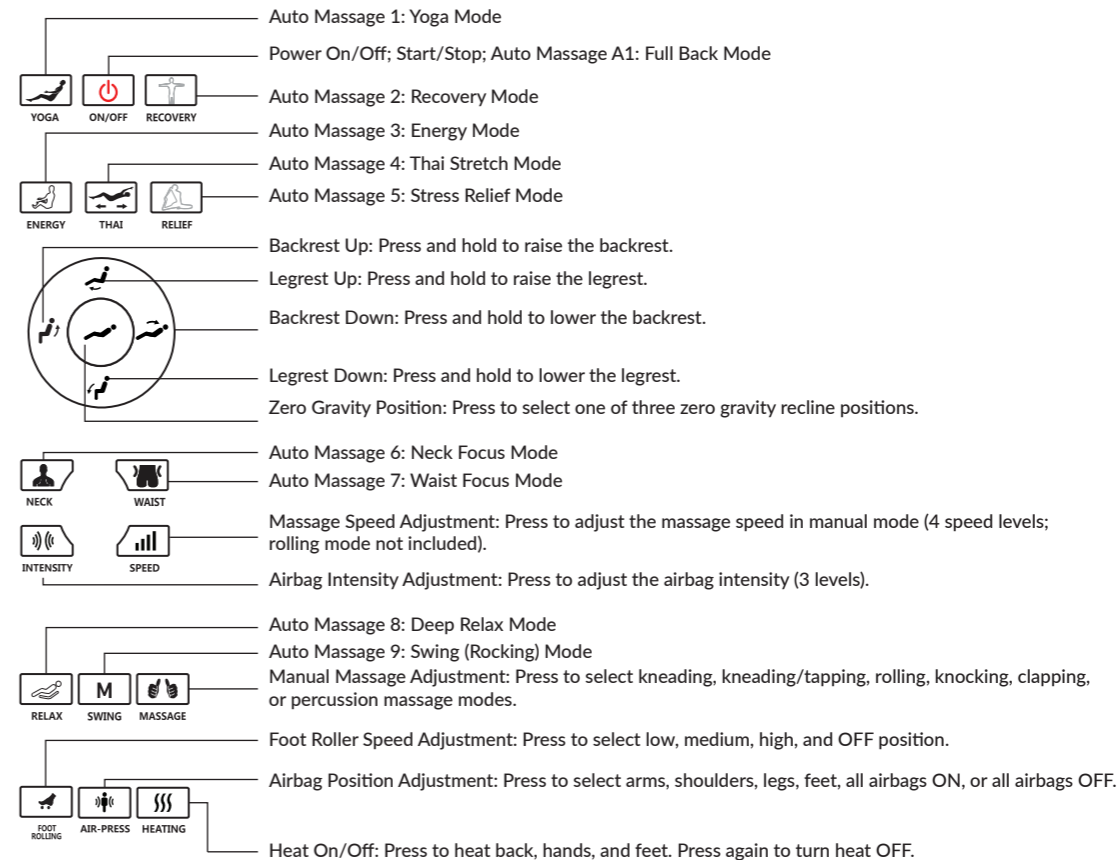

## ARM CONTROL

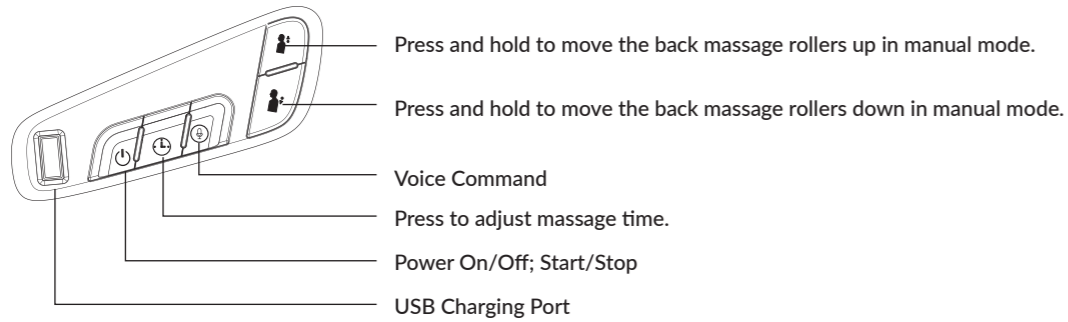
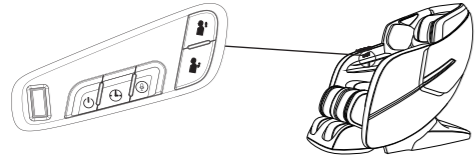

## VOICE COMMAND/BLUETOOTH

### VOICE COMMAND

To initiate voice command press the microphone button and say "CORENINE."  
Voice command will respond with "Yes."

Use the guide on the back of the remote control and speak your desired command.  
Example: "Start massage."

Voice command will stay on unless the power to the chair is turned off, or the microphone button is pressed again to turn off voice command.

### BLUETOOTH

Open Bluetooth on your smart phone and connect to CORENINE to play your music through the massage chair speakers.



## CLEANING INSTRUCTIONS

### WARNING

- Turn the main power switch off and disconnect the power plug from the electrical outlet before cleaning the chair to reduce the risk of electric shock.
- Never use wet hands to connect or disconnect the power plug from the electrical outlet.
- Do not use a damp cloth to clean the power cord.

### SYNTHETIC LEATHER CARE

- For general cleaning, wipe down the leather with a damp cloth, then a dry cloth.
- Avoid excessive brushing or rubbing while cleaning the leather.
- To remove stains, use a damp cloth with a 3-5% neutral detergent, then wipe with a dry cloth.
- Do not use benzene, thinner, alcohol, or any other solvent or abrasive cleansing agent on the leather.

### PLASTIC CARE

- Use a damp cloth with a 3-5% neutral detergent to clean the plastic components of the massage chair.
- Dry with a cloth or allow to air dry.

### REMOTE CONTROL CARE

- Do not use a damp cloth to clean the remote control. Use only a clean dry cloth.
- Do not use benzene, thinner, alcohol, or any other solvent or abrasive cleansing agent on the remote control.

## REPLACING A FUSE

To replace a fuse, turn the power control button to the OFF position and unplug the power cord. Remove the fuse cover lid and replace with the same sized fuse.

Contact a qualified electrician if you are unable to replace the fuse.

WARNING! Check with a qualified electrician or serviceman if you are in doubt as to whether your chair is properly grounded.

## STORING THE CHAIR

- Cover the chair while it is in storage.
- Do not store the chair outdoors or in direct sunlight.
- Do not store the chair in excessively hot, cold, humid, damp, or dusty environments.

## TRUBLESHOOTING

PROBLEM	POSSIBLE REASON FOR PROBLEM	TROUBLESHOOTING
There are sounds inside the massage chair when it is being used.	The air pump, motor and mechanical parts of your massage chair will make various beeping & humming sounds.	This is normal.
The massage chair suddenly stops working when it is being used.	The massage time may be complete.	Choose a new massage mode or turn off your massage chair.
	Your electrical power may have stopped working.	Check to make sure your power is connected.
The massage chair is connected to the power supply but the remote control is not working.	The power switch may not be turned on.	Turn on the power switch.
	The "On/Off" button on the remote control may not be turned on.	Turn the "On/Off" button on the remote control to the "On" position.
	The power cord plug may not be properly connected to a working electrical outlet.	Reconnect the power cord plug to a working electrical outlet.
	A fuse may have burned out.	Replace the fuse.
	The power cord may be damaged.	If damaged, contact your retailer's service department for a new power cord.
The massage chair becomes louder when it is being used.	The massage chair may be overloaded from extended use.	Turn off the massage chair for at least 30 minutes.
The massage chair will not extend, recline or return to its upright position.	There may be obstacles in the way.	Remove the obstacles.
	The massage chair may be overloaded from extended use.	Turn off the massage chair for at least 30 minutes.



ATTENTION

If you continue to have problems, turn off the main power switch, unplug the power cord from the electrical outlet and contact your retailer's service department or COREnine at [corenineusa.com](http://corenineusa.com).