



MUSHROOM CAT WATER FOUNTAIN

STYLE-S

READ BEFORE YOU START

Please identify and sort all components shown below.
For any issues during installation, please ask for assistance at service@happyandpolly.com or check our YouTube Channel https://www.youtube.com/channel/UCbPD98rZ-jOYrTCQA_0eNLg.

SAFETY GUIDELINES TO PREVENT INJURIES

- When using electrical appliances, basic safety precautions must always be followed to avoid the risk of fire, electric shock, and/or injury to persons.
- To avoid the risk of injury, close supervision is necessary when any appliance is used by or near children.
- To protect against electric shock, do not place the electrical power cord or plug in water or other liquids.
- Indoor household use only. Do not use outdoors or run dry.
- Unplug the fountain, then disconnect the in-line plug.
- To avoid the risk of electric shock, do not place or store an appliance where it can fall or be pulled into a bathtub or sink.
- Always unplug an appliance when it is not in use, before putting on or taking off parts, and before cleaning.
- Do not use an appliance for anything other than its intended use.
- Do not allow pets to chew on or swallow any parts. If you are concerned about the power cord, purchase a cord conduit (a hard plastic protector) at any hardware store.
- Do not attempt repairs on the pump.
- To avoid the possibility of the plug or electrical outlet getting wet, the electrical outlet should always be above the level of the fountain.
- If an extension cord is necessary, an extension cord with a proper rating should be used.

IMPORTANT

- Please identify and sort all components shown below.
- Only rinse the filter with water. Never wash the filter with soapy water as the soap residue will seep into the filter permanently.
- Use replacement filters authorized by Happy & Polly only. Using unauthorized filters may void the warranty.

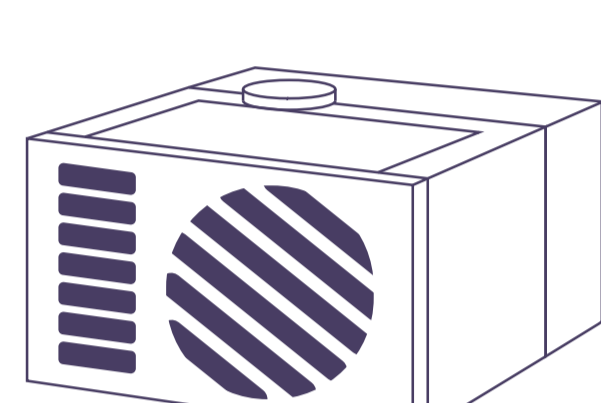

A Detachable Pump x 1

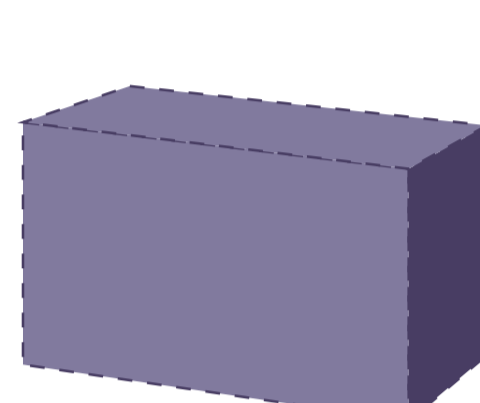

B Carbon Filter x 1

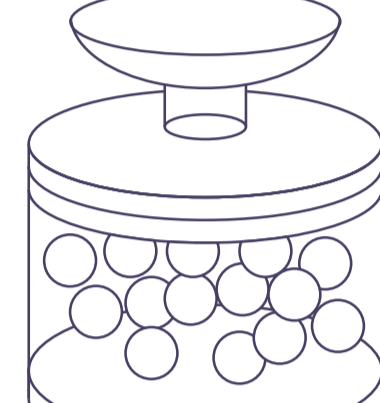

C Filter Box x 1

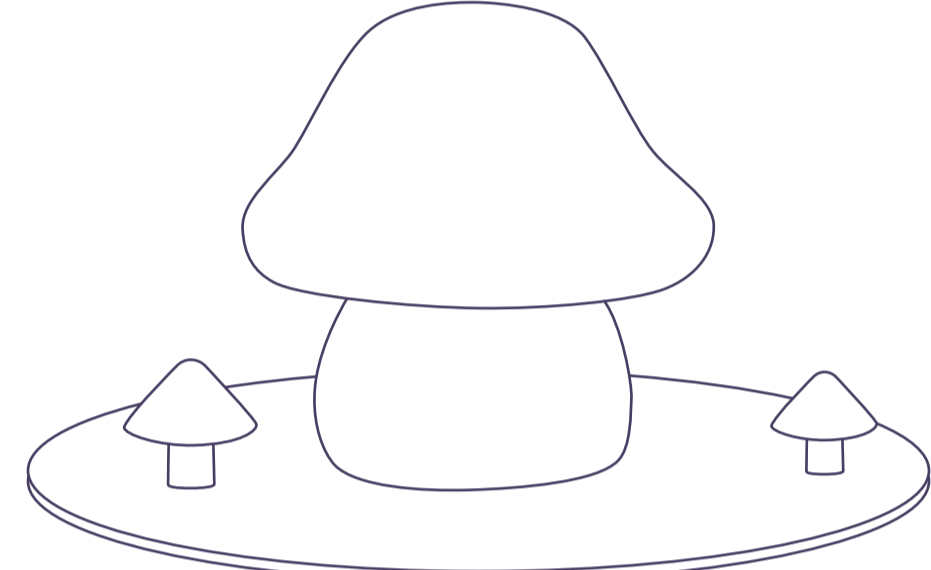

D Fountain With Detachable Lid x 1

ASSEMBLY INSTRUCTIONS

<https://www.youtube.com/watch?v=vJrBudXyMDk>

1

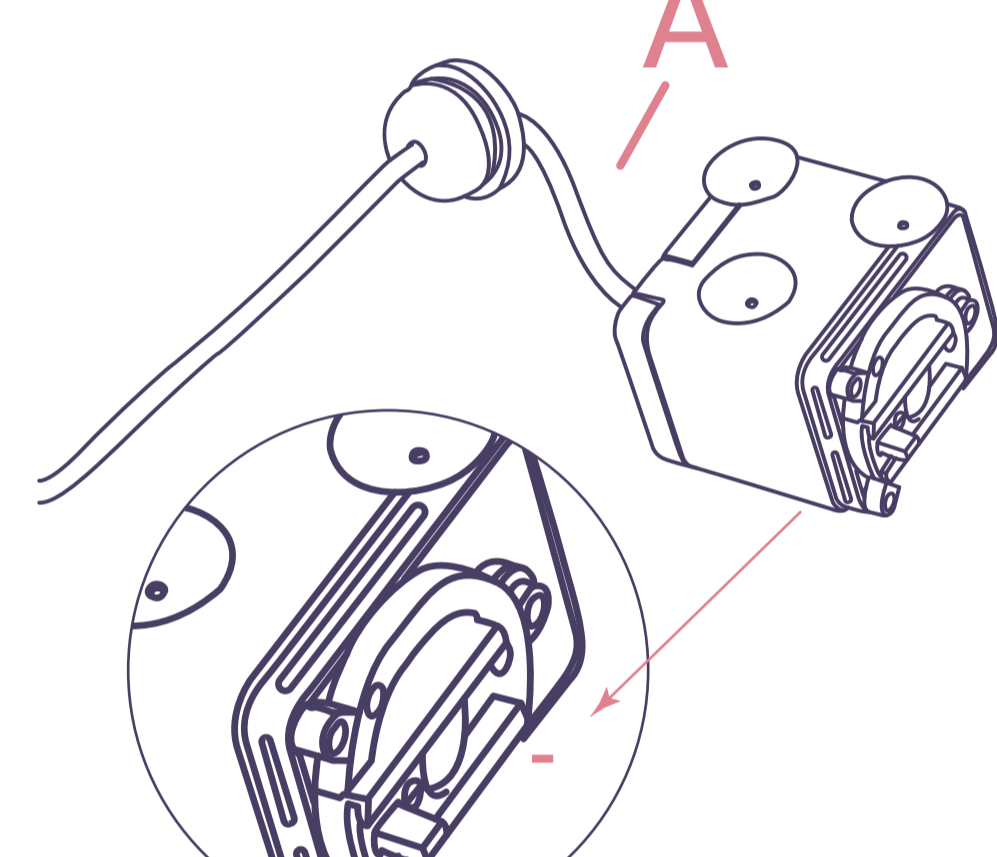

Adjust the button to control the flow.
+ is Max. Flow, - is Min. Flow

2

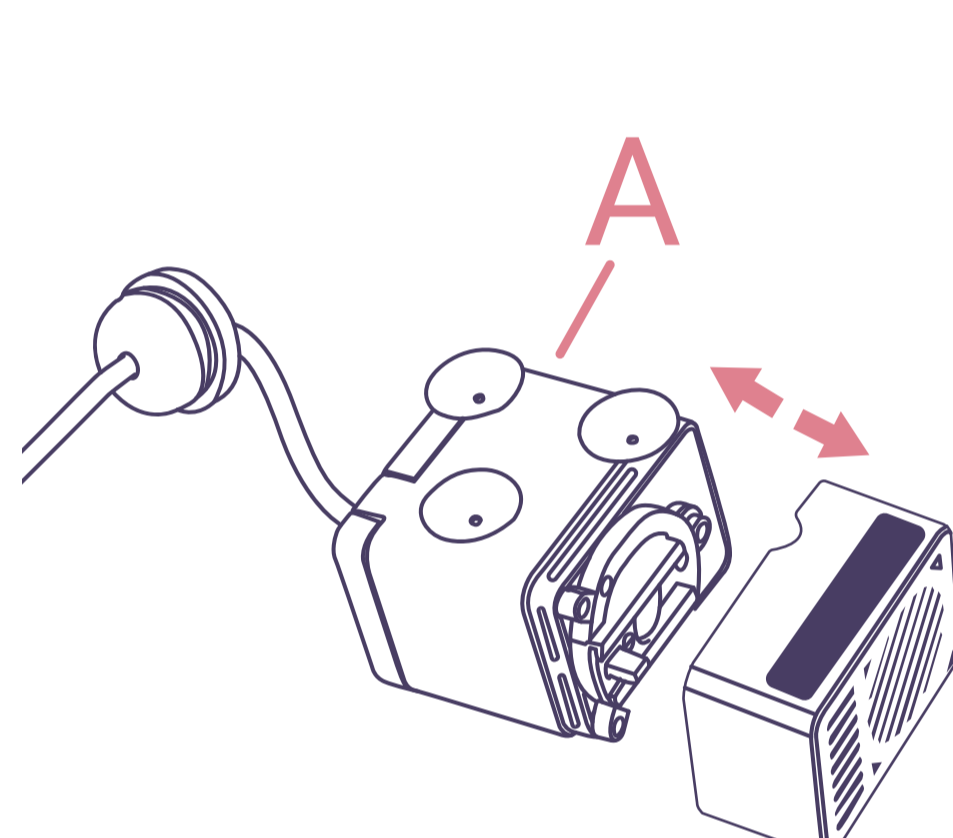

Detach the pump.
Fountain With Detachable Lid

3

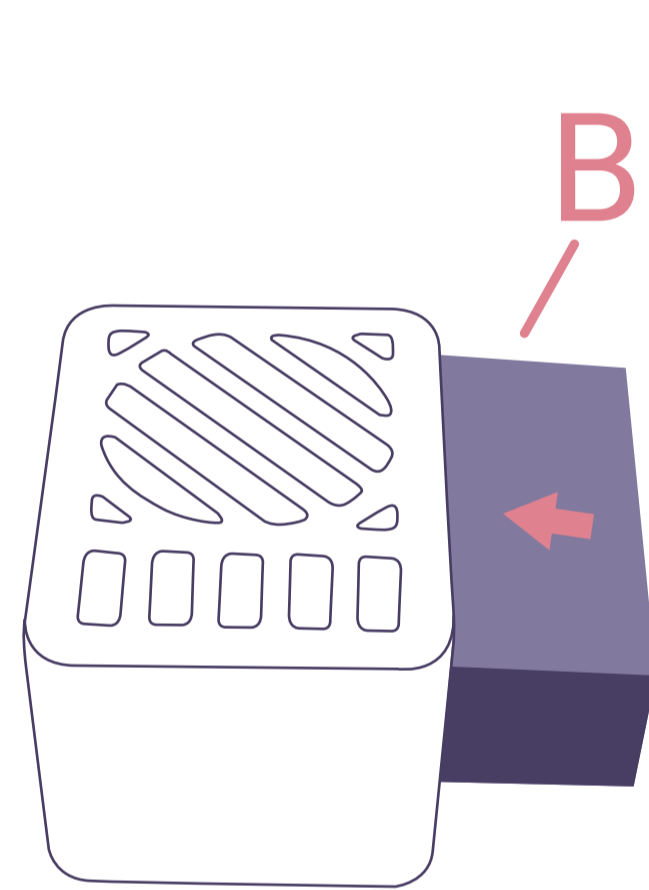

Insert the carbon filter.

4

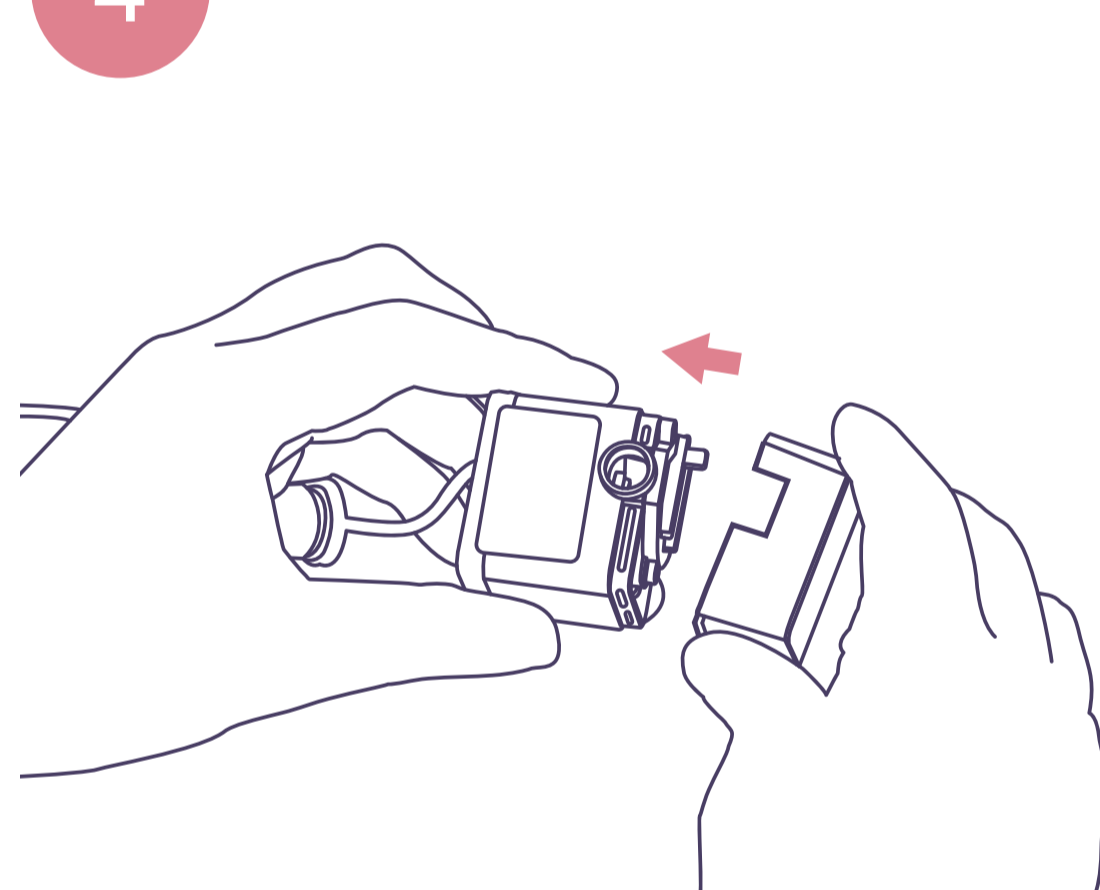

Recover the pump.

5

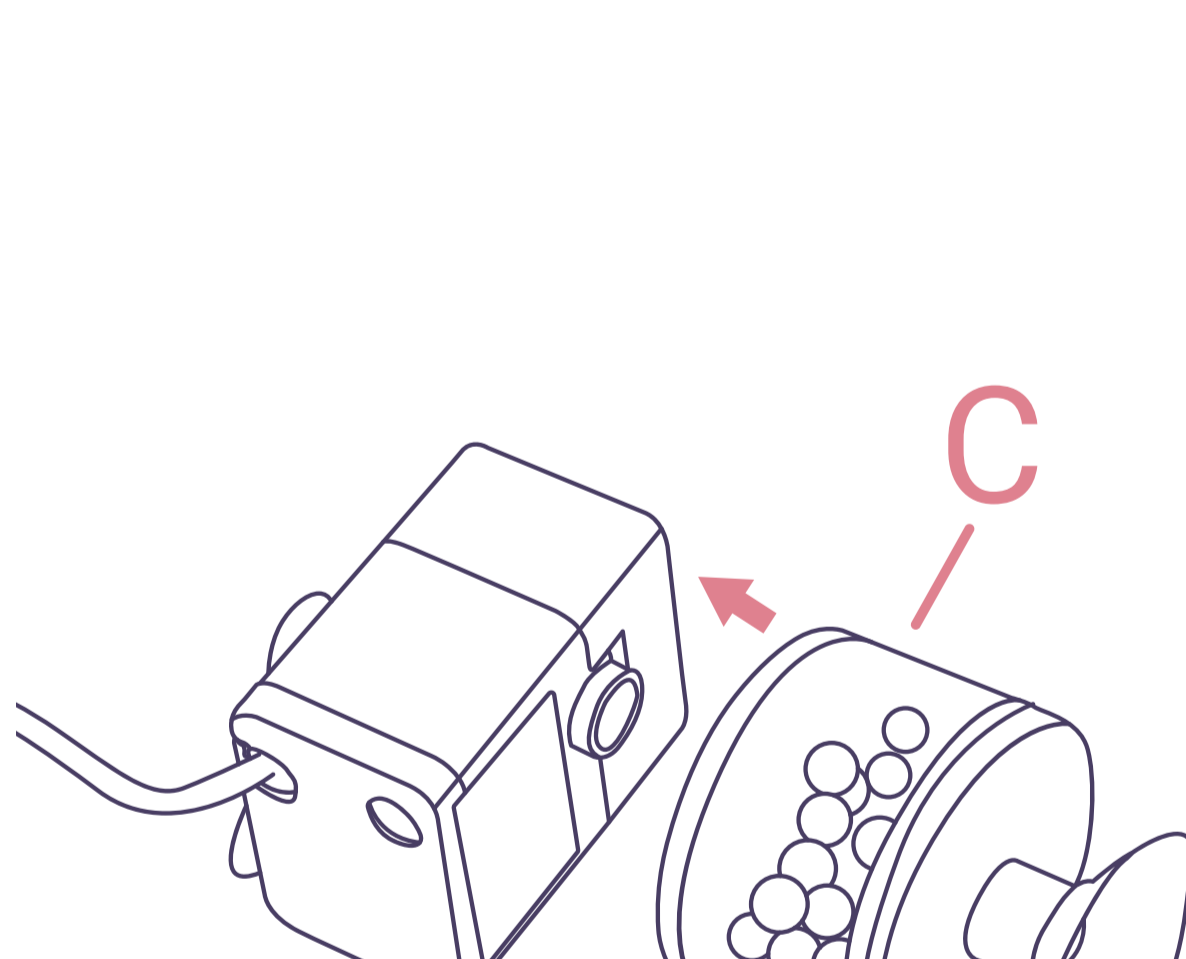

Assemble the pump and filter box.
The long side of the filter is connected to the sucker.

6

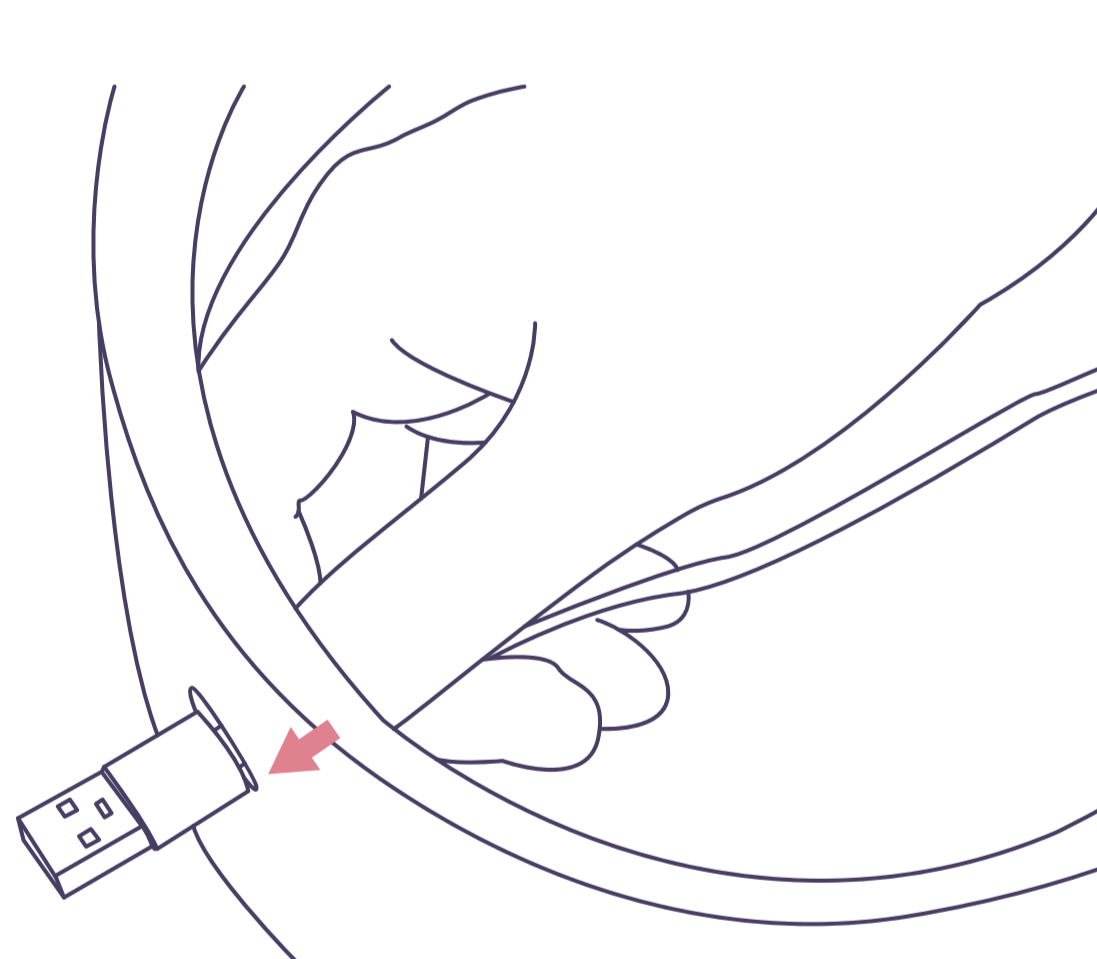

Make sure the USB cable through the fountain from the inside.

7

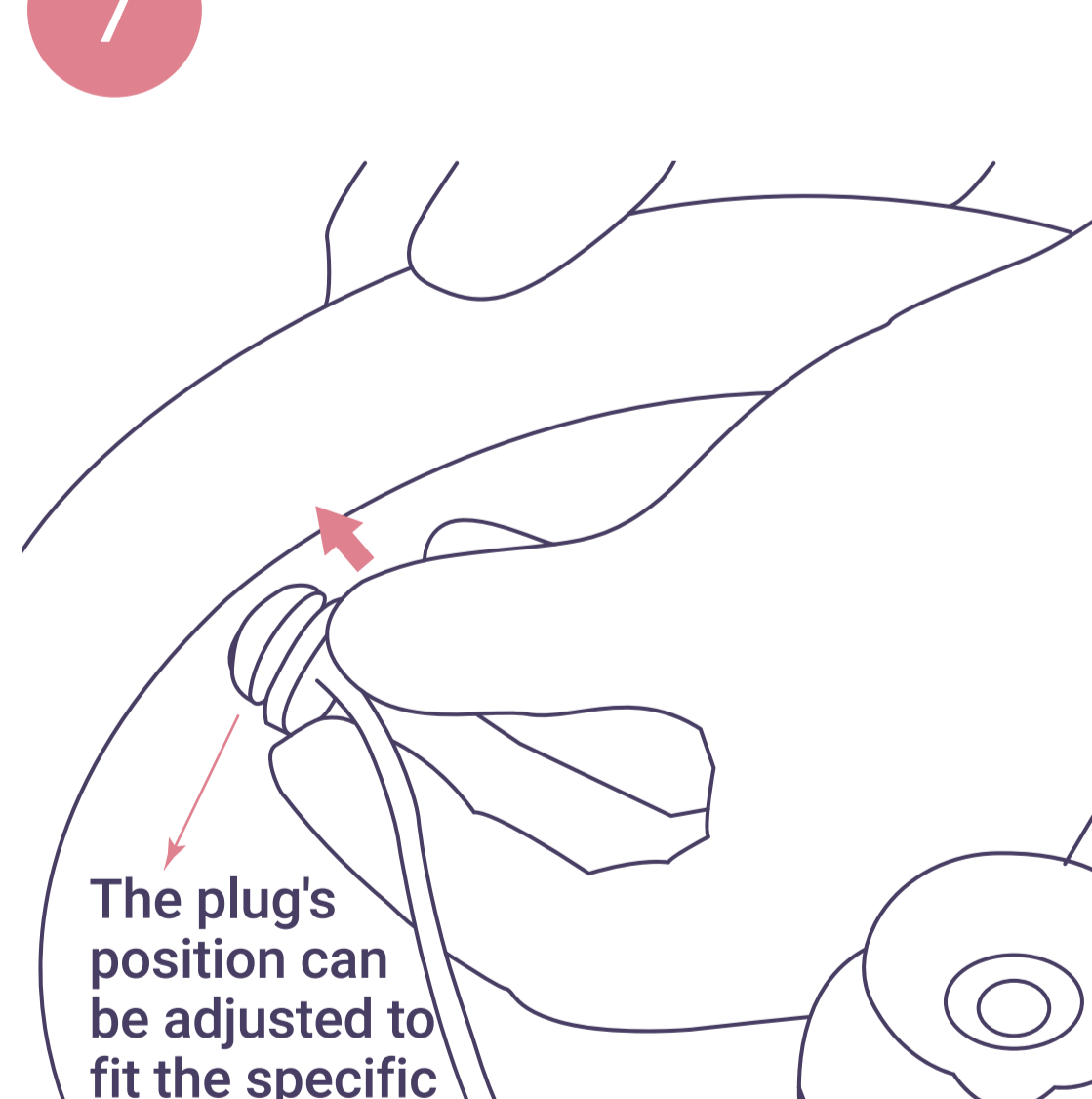

Make sure the fountain is sealed by the rubber plug tightly.

8

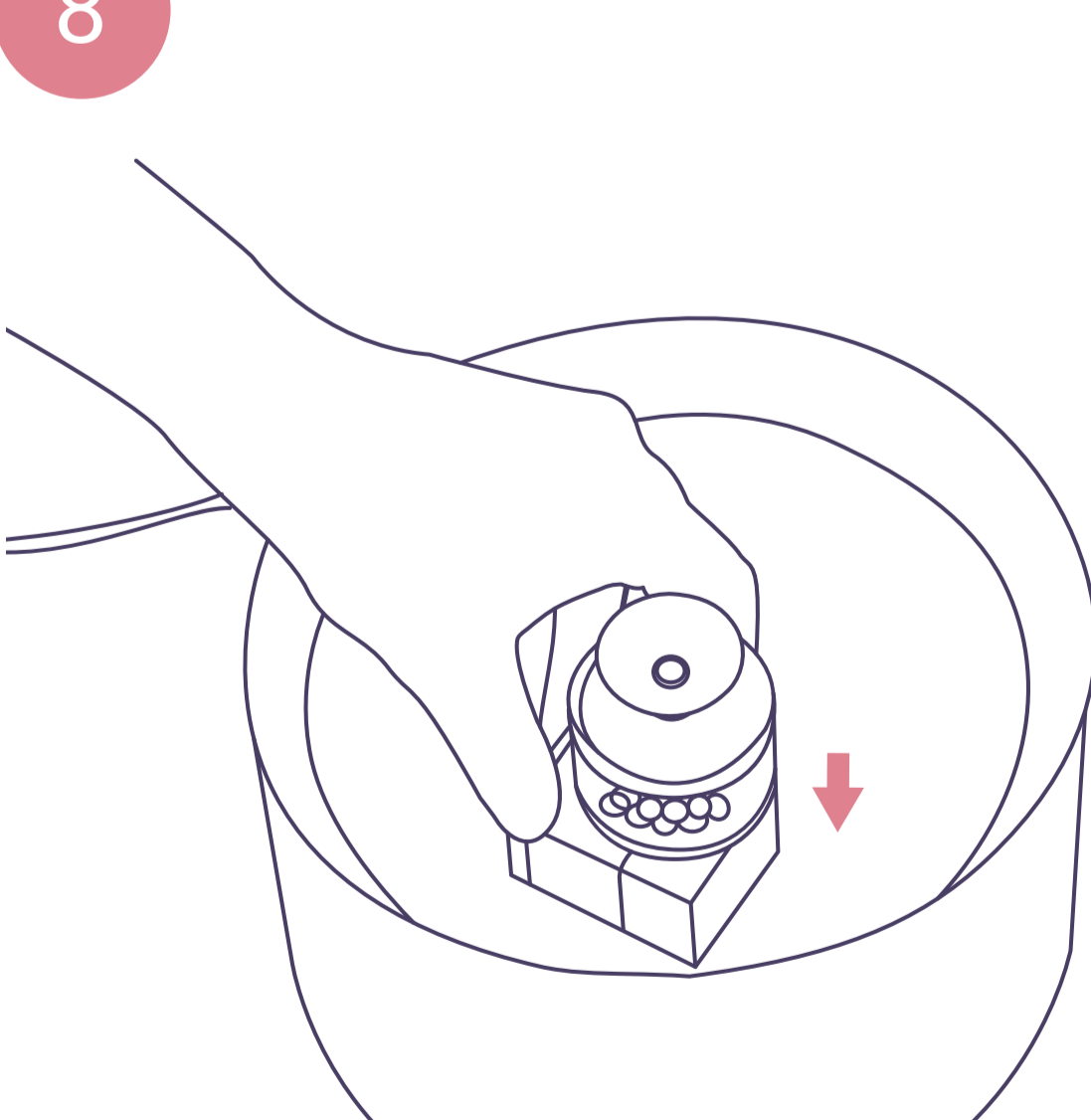

Put them in the middle of the fountain.

9

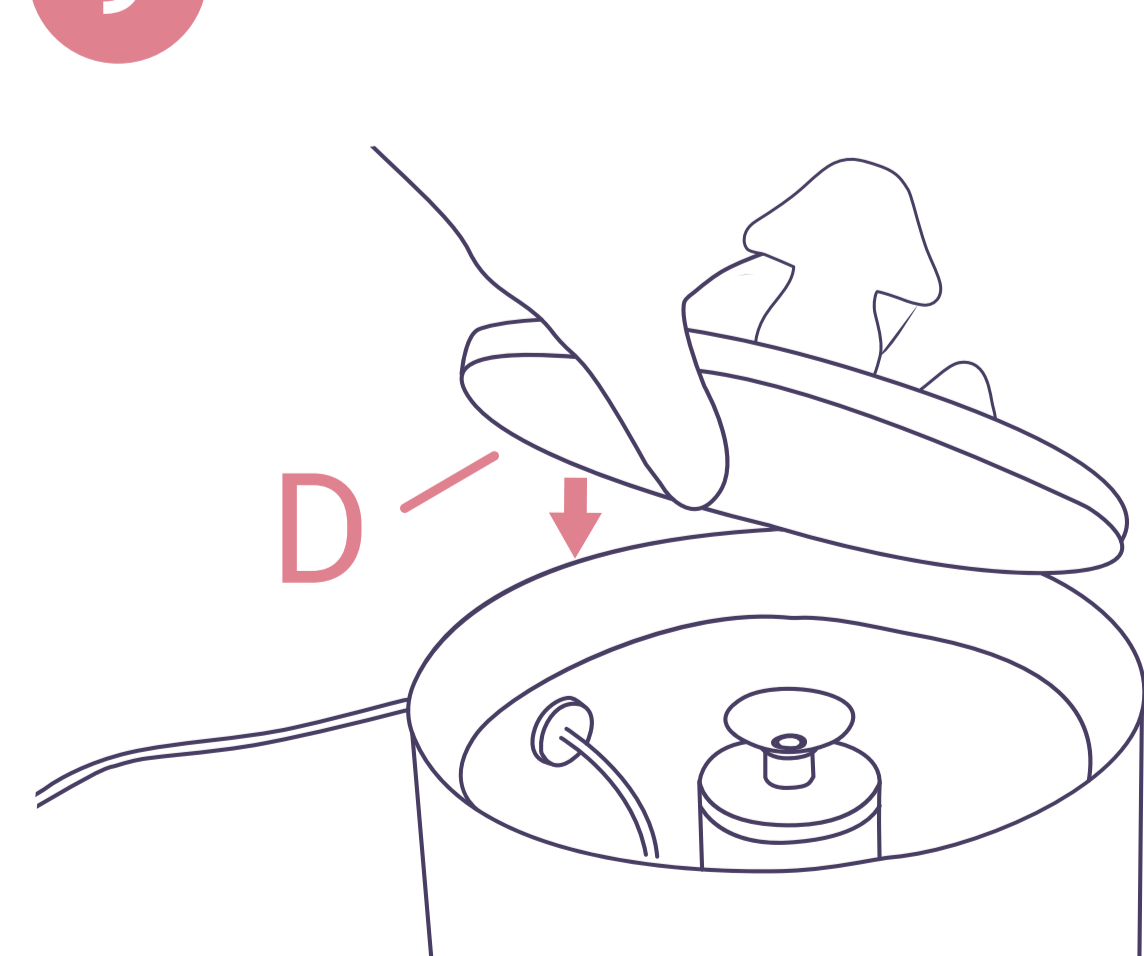

Adjust the cable.

CARE INSTRUCTION:

- When using for the first time, please rinse the filter box for 2 minutes to flush out impurities caused by collision.
- Clean the Water Fountain every 7 days.
- To achieve the ideal filtering effect, it is recommended to replace the filter box once a month.