





Alumni Educational Solutions

We have an obligation to be the Teacher's Assistant, the Architect's Inspiration and to support students in their learning environments.

Our primary goal is to inspire creative thought and create innovative classroom environments that allow adaptability to the ever changing ways of learning while giving students the opportunity to excel.

Educational practices are moving at the speed of light. The best way to assist the teacher is to design flexibility into the classroom. The ability to adapt learning environments at the same pace is critical to allow educators to leave no child behind.

We want to see each child given the opportunity to advance and receive the newest teaching methods.

All our products are designed, engineered and manufactured to strict quality standards that are inspected numerous times during our process, including a final inspection prior to packaging for shipment.

We look forward to making your classroom furniture purchase an enjoyable experience.

Table of Contents

7	21 st Century Learning	126 Tables
8	21 st Century Classroom Solutions	128 Honor Roll 136 Integrity 142 Creativity 148 Inspire 158 T-Leg / Y-Leg 162 Computer 170 Makerspace Works 176 Convertible Bench 177 Pedestal 178 Nesting 179 Science
10	Seating	
	12 Explorer 20 Air 28 Smooth 36 Integrity 44 Classic 50 Honor Roll 58 Marquis 64 Balance Stool 65 Makerspace Works Steel Stool 66 Soft Seating	
68	Desks	
	70 y5 78 Collaborative 98 Cantilever / T-Leg 104 Lift Lid 108 4-Leg 116 Double 120 Combo	
		180 Assembly Furniture
		182 Accelerator Active Learning Centers
		184 Accelerator Active Learning Centers
		198 Specialty Top Sizes
		200 Color Selector
		202 Accessories
		206 Customer Support





Collaborative Learning encourages active participation in the classroom. Working in smaller groups leads to discussions that develop a greater understanding of the subject matter among all participants.

The y5 Mission

Greater Understanding

Higher Achievement

Significantly Better Results

The foundation for a productive 21st Century Collaborative environment begins with the ability to position students in the most effective groupings. Studies show the most effective group sizing is 5. In a group of 5, eye contact through cross-directional positioning plays a major role in how all participants will participate and interact with one another.

Each group requires a teacher-selected mix of Overachievers, Middle-achievers and Underachievers. These diverse groupings will ensure engagement and participation by everyone in the group. With the suitable environment in place, the teacher becomes the 'Conductor of the Orchestra'; they will continually steer the comprehension of the subject matter onto its correct course.

Without a collaborative environment, a 50-minute class with 30 students would only allow the teacher just over one minute with each student and does not include any of the time spent teaching the lesson.

So Y5?

Studies show that groups of 5 are the most effective grouping number for collaborative learning:

If you measure the number of possible social interactions with varying groups, the optimal group size appears to be 5. The number of social interactions begins to explode in groups with more than 5 people.

– Sheila L. Margolis, PhD President
Workplace Culture Institute

Researchers report that, regardless of the subject matter, students working in small groups tend to learn more of what is taught and retain it longer than when the same content is presented in other instructional formats.

– Barbara Gross Davis
Tools for Teaching - Stanford University

Misperception: Bigger is better. Actually: Excessive size is one of the most common—and also one of the worst—impediments to effective collaboration.

– J. Richard Hackman
Harvard Business Review

Traditional Group of 4

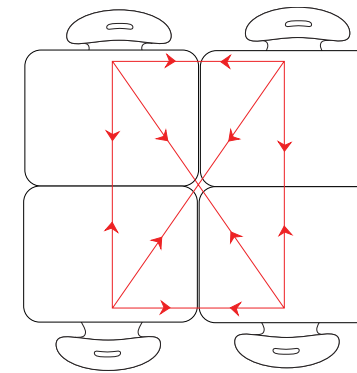

Traditional Group of 6

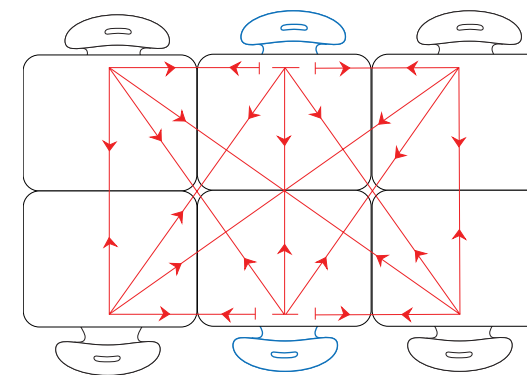

Group Leader Role
Created By Default
(Blue Chair)

Progressive Group of 5

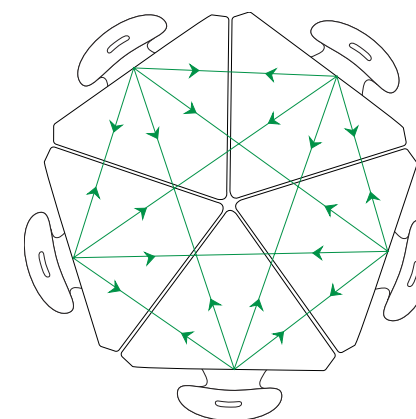

21st Century Learning

Connecting Mind and Body

In the K-12 Learning Space, our goal is to empower students to have equal influence and discussions within the group through the proper arrangement of desks and seating positions. A study from the University of Montana indicates that "Round or Pentagon Groups" create a 'Web Network', a cross-directional method of communication in which members are encouraged to communicate directly with each other, resulting in information being shared more rapidly and each member feeling they have an equal influence within the group.

Traditional Rectangular Groups

In the Traditional Rectangular Group of 4, there is often a pairing off of partners. Traditionally, this is the position that negotiators would prefer to be in and is recognized as a "Face Off" position.

When one more participant is added on each side of the group, creating a Traditional Rectangular Group of 6, two additional problems are created that are not conducive to a K-12 Collaboration:

1. A lack of visual contact with every group member occurs
2. The middle person in each row of three will typically end up taking on a dominant role of being a mediator or group leader

Progressive Round or Pentagon Groups

This type of seating arrangement is not new but can provide insight into the way that human interactions can be enhanced. The most famous example of this was King Arthur and the Knights of the Round Table: Every Knight that sat around the table was considered to be an equal to his peers and there was no central power position.

In the Progressive Round or Pentagon Group, visual contact is inclusive and there is no dominant seating position in the group. The ability to visually see all of the group members is vitally important since it promotes the ability to interact and share ideas. Through visual contact, body language is displayed in four different ways:

1. Head Movement
2. Facial Expressions
3. Body Posture
4. Hand and Finger Gestures

Simply by having visual contact with all group members, a quick determination about the participation levels can be made:

- Are all group members paying attention?
- Are all group members participating?
- Is there a sense of agreement or disagreement among the participants?
- Is anyone choosing not to participate?

This arrangement creates a more cooperative situation for discussion and a sense of equality.

The Alumni Y5 Collaborative Groupings are designed around the knowledge that we have gained through these recognized studies. The Alumni Y5 Practices implement this knowledge in the most effective manner, creating the footprint for the most successful outcomes in the rollout and implementation of 21st Century Collaborative Learning.

At Alumni, we strongly believe in following the path of research and proven concepts when developing furniture solutions. Our goal is to create the absolute best opportunity for all students to succeed within their education.

21st Century Classroom Solutions

Alumni y5 Collaborative Groupings



The foundation for the implementation of a productive 21st Century Collaborative Learning environment begins with the ability to position students in the most effective collaborative groupings; studies show that the most effective grouping size is 5. Supportive research has been pivotal in the design and development of the y5 Flow, Pente and Idea Desks.

The original Flow Desk is a classroom solution that is appropriate for both traditional and progressive teaching styles. The unique shape and size of the Flow takes into consideration classroom size and is a solution that allows for multiple, functional group configurations while providing the option of individual testing or independent study.

For more information on the Flow Desk, please turn to pages 72-73.



Flow Desk



Pente Desk

The Pente and Idea Desks have a unique pentagonal shape that takes into consideration the need for furniture that is both a functional and a practical solution for 21st Century Learning. In their ideal groupings of 5, they support a Web Network-type of communication, allowing for cross-directional dialogue to occur during collaboration.

For more information on the Pente Desk, please turn to pages 74-75.

For more information on the Idea Desk, please turn to pages 76-77.



Idea Desk

21st Century Classroom Solutions

Alumni Complete Product Blend



The Alumni Soft Seating Series was developed to enhance any learning commons, student lounge or library. There are a multitude of combinations and configurations that can be accomplished with the range of shapes and sizes available.

For more information on Soft Seating, please turn to pages 66-67.

The Alumni Makerspace Works Steel Stool provides a modern and practical solution for versatile classrooms that engage students through multiple learning techniques.

For more information on the Makerspace Works Steel Stool please turn to page 65.



The Alumni Makerspace Works Tables are a practical and adaptable table solution for several classroom settings. By having a collection of top materials, these tables can be utilized in any learning environment.

For more information on the Makerspace Works Tables, please turn to pages 172-174.

The Alumni Accelerator Teacher Desk and Sit-Stand Crescent Desks are products that when combined are a modern twist on the traditional teacher desks as they provide teachers a space to meet with one or more students comfortably while being mobile.

For more information on the Accelerator Teacher Desk and Sit-Stand Crescent Desks, please turn to pages 194-195.



The Alumni Accelerator Active Learning Centers are multi-functional and are equipped with a variety of options to match the fast-paced and moving classroom environments.

For more information on the Accelerator Active Learning Centers, please turn to pages 186-193.

Seating

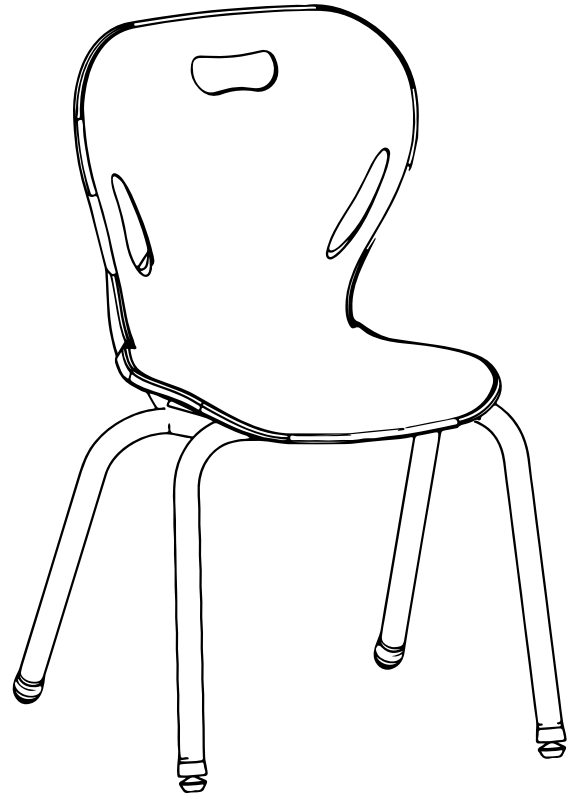

Our unique designs and versatility in the classroom provide the support needed to enhance student learning.



Seating Explorer



4-Leg



Caster



Task Height



Lab Height



Cafe 4-Leg



Cafe Cantilever



Cantilever



Rocker

The Explorer Chair Shell is maintenance-friendly and easy to clean with a Center "Power Rib". Its unique patented flat ribbing support system provides lumbar support with just the right amount of flexibility.



Shown with optional Chrome Frame

4-Leg

The Alumni Explorer 4-Leg Stacking Chair is developed for use in any learning environment. It can stack eight chairs high freestanding, locking into one another for stability.

- Rugged Polypropylene Seat Shell
- 1 1/8" O.D. 18-Gauge Steel Frame
- 100% Polyester Premium Powder Coat Finish
- Standard Glides: Marquis Nylon Swivel
- Optional Glides: Marquis Steel Swivel, Marquis Neoprene Swivel, Felt Snap-On, Q-Ball or Quiet Glide
- Options: Chrome Frame, Book Rack (18" only), Music Pitch (18" only), Ganging, Padded Seat, CAL 133 Compliant

Model	Size	Wt. (lbs)	Freight Class
C-EXPL-18XL	Senior XL: 18"	13.5	150
C-EXPL-18	Senior: 18"	12.5	150
C-EXPL-16	Senior: 16"	12.5	150
C-EXPL-14	Junior: 14"	8	150
C-EXPL-12	Junior: 12"	8	150



Task Height



Lab Height

Task Height Gas Lift (GL): Provides comfortable seating for Computer Labs and Training Rooms.

Lab Height Gas Lift with Foot Ring (GLR): Provides comfortable seating for the Arts and Sciences. Convenient integral chrome foot ring is included for extra comfort.

- Rugged Polypropylene Seat Shell
- Black Molded Nylon Frame
- Standard Casters: Dual Wheel Urethane Caster
- Options: Fixed Glides, Padded Seat, CAL 133 Compliant

Model	Size	Wt. (lbs)	Freight Class
C-EXPL-GL	Senior: from 16"-19"	18.2	KD 70
C-EXPL-GL-XL	Senior: from 16"-19"	18.2	KD 70
C-EXPL-GLR	Senior: from 21.5"-29"	21.6	KD 70
C-EXPL-GLR-XL	Senior: from 21.5"-29"	21.6	KD 70



Shown with optional Chrome Frame

Caster

The Alumni Explorer Caster Chair's dual wheel system encourages flexibility in any environment, allowing for quick and easy changes to classroom configurations throughout the day.

- Rugged Polypropylene Seat Shell
- 1 1/8" O.D. 18-Gauge Steel Frame
- 100% Polyester Premium Powder Coat Finish
- Standard Casters: Dual Wheel Urethane Caster
- Options: Chrome Frame, Padded Seat, CAL 133 Compliant

Model	Size	Wt. (lbs)	Freight Class
C-EXPL-CA-18XL	Senior XL: 18"	14	150
C-EXPL-CA-18	Senior: 18"	13	150

4-Leg and Caster Material Selector

Polypropylene Shell

- Black
- Charcoal
- Graphite
- Chocolate
- Pumpkin
- Yellow
- Sunburst
- Hunter Green
- Apple Green
- Navy Blue
- Royal Blue
- Sky Blue
- Plum
- Burgundy
- Crimson
- Red

Frame

- Black
- Hammettone Black
- Hammettone Gray
- Dark Gray
- Gray
- Metallic
- Chrome
- Beige
- Hunter Green
- Navy Blue
- Burgundy

Task and Lab Height Material Selector

Polypropylene Shell

- Black
- Charcoal
- Graphite
- Chocolate
- Pumpkin
- Yellow
- Sunburst
- Hunter Green
- Apple Green
- Navy Blue
- Royal Blue
- Sky Blue
- Plum
- Burgundy
- Crimson
- Red





Cafe 4-Leg



Cafe Cantilever

Cafe Height 4-Leg Chair (CAFE): Developed for use in any learning environment and stacks four high for easy storage.

Cafe Height Cantilever Chair (CAFE-CANT): Designed with a contemporary cantilever-style base stool with heavy gauge oval tubing that creates a fresh and modern look.

- Rugged Polypropylene Seat Shell
- Heavy Gauge Tubular Steel Frame
- Chrome Finish
- Cafe Cantilever Standard Glides: Floor-Friendly
- Cafe 4-Leg Standard Glides: Marquis Nylon Swivel
- Cafe 4-Leg Optional Glides: Marquis Steel Swivel, Marquis Neoprene Swivel, Felt Snap-On, Q-Ball or Quiet Glide
- Option: CAL 133 Compliant

Model	Size	Wt. (lbs)	Freight Class
C-EXPL-CAFE-30	Senior: 30"	17	150
C-EXPL-CAFE-24	Senior: 24"	16	150
C-EXPL-CAFE-CANT-30	Senior: 30"	21	150
C-EXPL-CAFE-CANT-24	Senior: 24"	20	150

Cafe Height Material Selector

Polypropylene Shell

- Black
- Charcoal
- Graphite
- Chocolate
- Pumpkin
- Yellow
- Sunburst
- Hunter Green
- Apple Green
- Navy Blue
- Royal Blue
- Sky Blue
- Plum
- Burgundy
- Crimson
- Red

Frame

- Chrome



Cantilever

The Alumni Explorer Cantilever Stacking Chair's unique leg design puts a modern twist on the classic student chair. Four leveling bumpers on the underside of the seat prevents marking and allows the chair to rest safely on work surfaces.

- Rugged Polypropylene Seat Shell
- 1" O.D. Heavily Reinforced Tubular Steel Frame
- Chrome Finish
- Standard Glides: Floor-Friendly
- Optional Glides: Stainless Steel
- Options: Book Rack (18" only), Ganging, Padded Seat, CAL 133 Compliant

Model	Size	Wt. (lbs)	Freight Class
C-EXPL-CANT-18XL	Senior XL: 18"	15.5	150
C-EXPL-CANT-18	Senior: 18"	14.4	150
C-EXPL-CANT-16	Senior: 16"	14.4	150
C-EXPL-CANT-14	Junior: 14"	10.2	150
C-EXPL-CANT-12	Junior: 12"	9.4	150

Rocker

The Alumni Explorer Rocker Chair's soothing rocking motion brightens the mood in any learning environment. Appropriate for students of all abilities to be utilized within reading nooks, classrooms, and side chairs.

- Rugged Polypropylene Seat Shell
- 1" O.D. Heavily Reinforced Tubular Steel Frame
- Chrome Finish
- Standard Glides: Floor-Friendly Glide
- Option: CAL 133 Compliant



Model	Size	Wt. (lbs)	Freight Class
C-EXPL-ROCKER-18	Senior: 18"	15	150
C-EXPL-ROCKER-16	Senior: 16"	15	150
C-EXPL-ROCKER-14	Junior: 14"	11	150
C-EXPL-ROCKER-12	Junior: 12"	11	150

Cantilever and Rocker Material Selector

Polypropylene Shell

- Black
- Charcoal
- Graphite
- Chocolate
- Pumpkin
- Yellow
- Sunburst
- Hunter Green
- Apple Green
- Navy Blue
- Royal Blue
- Sky Blue
- Plum
- Burgundy
- Crimson
- Red

Frame

- Chrome



Seating Chart

4-Leg



Caster



Cafe 4-Leg



Cafe Cantilever



Cantilever

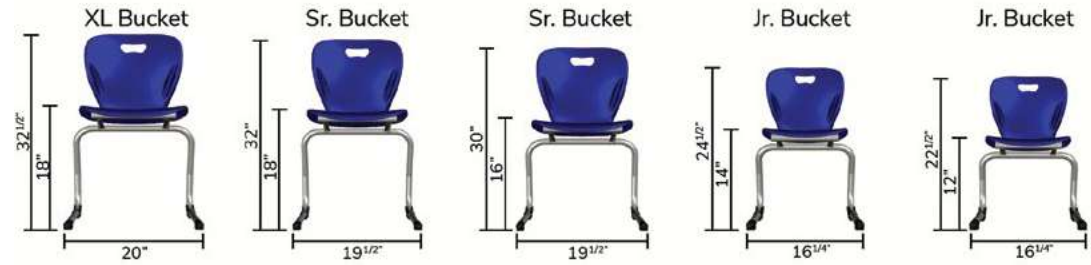

Rocker

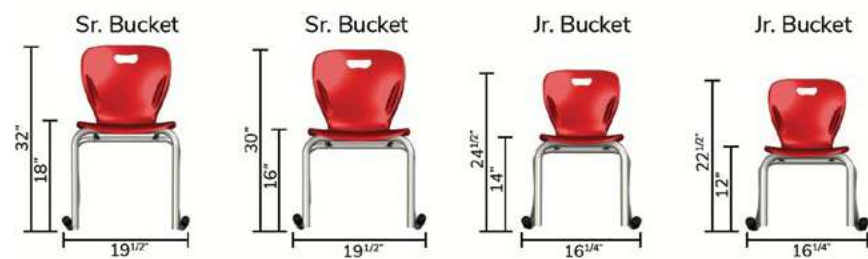



4-Leg



Caster



Task Height



Lab Height



Cafe 4-Leg



Cafe Cantilever



Cantilever



Rocker

The Air Chair Shell has unique ventilation holes which were engineered to provide just the right amount of breathability for students and teachers. Its waterfall seat edge and hourglass shape promotes better circulation and proper lumbar/shoulder support by reducing pressure points to enhance ergonomic comfort.





Shown with optional Chrome Frame

4-Leg

The Alumni Air 4-Leg Stacking Chair is developed for use in any learning environment. It can stack five chairs high freestanding, locking into one another when stacked for stability.

- Polypropylene-Molded Seat Shell
- 1" O.D. 16-Gauge Steel Frame
- 100% Polyester Premium Powder Coat Finish
- Standard Glides: Marquis Nylon Swivel
- Optional Glides: Marquis Steel Swivel, Marquis Neoprene Swivel, Felt Snap-On, Q-Ball or Quiet Glide
- Options: Chrome Frame, Book Rack (18" only), Music Pitch (18" only), Ganging, CAL 133 Compliant

Model	Size	Wt. (lbs)	Freight Class
C-AIR-18	Senior: 18"	13.7	150
C-AIR-16	Senior: 16"	13.7	150
C-AIR-14	Junior: 14"	9.5	150
C-AIR-12	Junior: 12"	9.5	150



Task Height



Lab Height

Task Height Gas Lift (GL): Provides comfortable seating for Computer Labs and Training Rooms.

Lab Height Gas Lift with Foot Ring (GLR): Provides comfortable seating for the Arts and Sciences. Convenient integral chrome foot ring is included for extra comfort.

- Polypropylene-Molded Seat Shell
- Black Molded Nylon Frame
- Standard Casters: Dual Wheel Urethane Caster
- Options: Fixed Glides, CAL 133 Compliant

Model	Size	Wt. (lbs)	Freight Class
C-AIR-GL	Senior: from 15.5"-18"	20	KD 70
C-AIR-GLR	Senior: from 21.5"-28.25"	22	KD 70



Shown with optional Chrome Frame

Caster

The Alumni Air Caster Chair's dual wheel system encourages flexibility in any environment, allowing for quick and easy changes to classroom configurations throughout the day.

- Polypropylene-Molded Seat Shell
- 1"O.D. 16-Gauge Steel Frame
- 100% Polyester Premium Powder Coat Finish
- Standard Casters: Dual Wheel Urethane Caster
- Options: Chrome Frame, CAL 133 Compliant

Model	Size	Wt. (lbs)	Freight Class
C-AIR-CA-18	Senior: 18"	14.7	150

4-Leg and Caster Material Selector

Polypropylene Shell

- Black
- Charcoal
- Graphite
- Chocolate
- Pumpkin
- Yellow
- Sunburst
- Hunter Green
- Apple Green
- Navy Blue
- Royal Blue
- Sky Blue
- Plum
- Burgundy
- Crimson
- Red

Frame

- Black
- Hammettone Black
- Hammettone Gray
- Dark Gray
- Gray
- Metallic
- Chrome
- Beige
- Hunter Green
- Navy Blue
- Burgundy

Task and Lab Height Material Selector

Polypropylene Shell

- Black
- Charcoal
- Graphite
- Chocolate
- Pumpkin
- Yellow
- Sunburst
- Hunter Green
- Apple Green
- Navy Blue
- Royal Blue
- Sky Blue
- Plum
- Burgundy
- Crimson
- Red





Cafe 4-Leg



Cafe Cantilever

Cafe Height 4-Leg Chair (CAFE): Developed for use in any learning environment and stacks four high for easy storage.

Cafe Height Cantilever Chair (CAFE-CANT): Designed with a contemporary cantilever-style base stool with heavy gauge oval tubing that creates a fresh and modern look.

- Polypropylene-Molded Seat Shell
- Heavy Gauge Tubular Steel Frame
- Chrome Finish
- Cafe Cantilever Standard Glides: Floor-Friendly
- Cafe 4-Leg Standard Glides: Marquis Nylon Swivel
- Cafe 4-Leg Optional Glides: Marquis Steel Swivel, Marquis Neoprene Swivel, Felt Snap-On, Q-Ball or Quiet Glide
- Option: CAL 133 Compliant

Model	Size	Wt. (lbs)	Freight Class
C-AIR-CAFE-30	Senior: 30"	18.2	150
C-AIR-CAFE-24	Senior: 24"	17	150
C-AIR-CAFE-CANT-30	Senior: 30"	24	150
C-AIR-CAFE-CANT-24	Senior: 24"	23	150

Cafe Height Material Selector

Polypropylene Shell

- Black
- Charcoal
- Graphite
- Chocolate
- Pumpkin
- Yellow
- Sunburst
- Hunter Green
- Apple Green
- Navy Blue
- Royal Blue
- Sky Blue
- Plum
- Burgundy
- Crimson
- Red

Frame

- Chrome



Cantilever

The Alumni Air Cantilever Stacking Chair's unique leg design puts a modern twist on the classic student chair. Four leveling bumpers on the underside of the seat prevents marking and allows the chair to rest safely on work surfaces.

- Polypropylene-Molded Seat Shell
- 1" O.D. Heavily Reinforced Tubular Steel Frame
- Chrome Finish
- Standard Glides: Floor-Friendly
- Optional Glides: Stainless Steel
- Options: Book Rack (18" only), Ganging, CAL 133 Compliant

Model	Size	Wt. (lbs)	Freight Class
C-AIR-CANT-18	Senior: 18"	17	150
C-AIR-CANT-16	Senior: 16"	17	150
C-AIR-CANT-14	Junior: 14"	11	150
C-AIR-CANT-12	Junior: 12"	11	150

Rocker

The Alumni Air Rocker Chair's soothing rocking motion brightens the mood in any learning environment. Appropriate for students of all abilities to be utilized within reading nooks, classrooms, and side chairs.

- Polypropylene-Molded Seat Shell
- 1" O.D. Heavily Reinforced Tubular Steel Frame
- Chrome Finish
- Standard Glides: Floor-Friendly
- Option: CAL 133 Compliant



Model	Size	Wt. (lbs)	Freight Class
C-AIR-ROCKER-18	Senior: 18"	18	150
C-AIR-ROCKER-16	Senior: 16"	18	150
C-AIR-ROCKER-14	Junior: 14"	12.5	150
C-AIR-ROCKER-12	Junior: 12"	12.5	150

Cantilever and Rocker Material Selector

Polypropylene Shell

- Black
- Charcoal
- Graphite
- Chocolate
- Pumpkin
- Yellow
- Sunburst
- Hunter Green
- Apple Green
- Navy Blue
- Royal Blue
- Sky Blue
- Plum
- Burgundy
- Crimson
- Red

Frame

- Chrome

Seating Chart

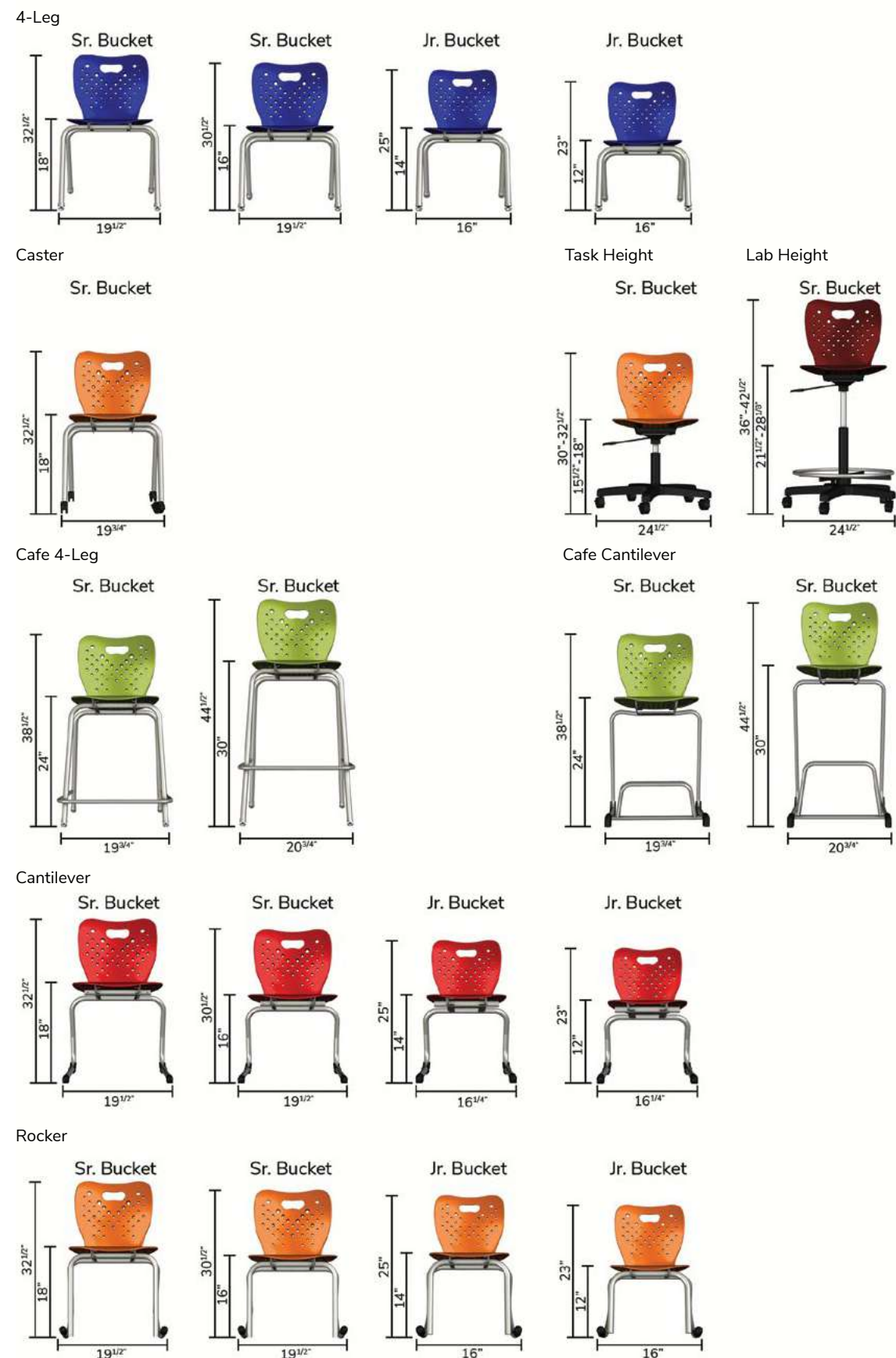

Seating Smooth



4-Leg



Caster



Task Height



Lab Height



Cafe 4-Leg



Cafe Cantilever



Cantilever



Rocker

The Smooth Chair Shell features a smooth, rib-less back with a blow-molded cavity to provide high back/shoulder support. Its waterfall seat edge and hourglass shape promotes better circulation and proper lumbar/shoulder support by reducing pressure points to enhance ergonomic comfort. Its square-textured seat is easy to maintain and adds design flair.



Shown with optional Chrome Frame

4-Leg

The Alumni Smooth 4-Leg Stacking Chair is developed for use in any learning environment. It can stack five chairs high freestanding, locking into one another when stacked for stability.

- Polypropylene-Molded Seat Shell
- 1" O.D. 16-Gauge Tubular Steel Frame
- 100% Polyester Premium Powder Coat Finish
- Standard Glides: Marquis Nylon Swivel Glide
- Optional Glides: Marquis Steel Swivel, Marquis Neoprene Swivel, Felt Snap-On, Q-Ball or Quiet Glide
- Options: Chrome Frame, Book Rack (18" Only), Music Pitch (18" only), Ganging, Padded Seat, CAL 133 Compliant

Model	Size	Wt. (lbs)	Freight Class
C-SM-18	Senior: 18"	14	150
C-SM-16	Senior: 16"	14	150
C-SM-14	Junior: 14"	10	150
C-SM-12	Junior: 12"	10	150



Shown with optional Chrome Frame

Caster

The Alumni Smooth Caster Chair's dual wheel system encourages flexibility in any environment, allowing for quick and easy changes to classroom configurations throughout the day.

- Polypropylene-Molded Seat Shell
- 1" O.D. 6-Gauge Tubular Steel Frame
- 100% Polyester Premium Powder Coat Finish
- Standard Casters: Dual Wheel Urethane Caster
- Options: Chrome Frame, Padded Seat, CAL 133 Compliant

Model	Size	Wt. (lbs)	Freight Class
C-SM-CA-18	Senior: 18"	17	150

4-Leg and Caster Material Selector

Polypropylene Shell

- Black
- Charcoal
- Graphite
- Chocolate
- Pumpkin
- Yellow
- Sunburst
- Hunter Green
- Apple Green
- Navy Blue
- Royal Blue
- Sky Blue
- Plum
- Burgundy
- Crimson
- Red

Frame

- Black
- Hammettone Black
- Hammettone Gray
- Dark Gray
- Gray
- Metallic
- Chrome
- Beige
- Hunter Green
- Navy Blue
- Burgundy



Task Height



Lab Height

Task Height Gas Lift (GL): Provides comfortable seating for Computer Labs and Training Rooms.

Lab Height Gas Lift with Foot Ring (GLR): Provides comfortable seating for the Arts and Sciences. Convenient integral chrome foot ring is included for extra comfort.

- Polypropylene-Molded Seat Shell
- Black Molded Nylon Frame
- Standard Casters: Dual Wheel Urethane Caster
- Options: Fixed Glides, Padded Seat, CAL 133 Compliant

Model	Size	Wt. (lbs)	Freight Class
C-SM-GL	Senior: 15.5"-18"	18.6	KD 70
C-SM-GLR	Senior: 21.5"-28.25"	22.6	KD 70

Task and Lab Height Material Selector

Polypropylene Shell

- Black
- Charcoal
- Graphite
- Chocolate
- Pumpkin
- Yellow
- Sunburst
- Hunter Green
- Apple Green
- Navy Blue
- Royal Blue
- Sky Blue
- Plum
- Burgundy
- Crimson
- Red





Cafe 4-Leg



Cafe Cantilever

Cafe Height 4-Leg Chair (CAFE): Developed for use in any learning environment and stacks four high for easy storage.

Cafe Height Cantilever Chair (CAFE-CANT): Designed with a contemporary cantilever-style base stool with heavy gauge oval tubing that creates a fresh and modern look.

- Polypropylene-Molded Seat Shell
- Heavy Gauge Tubular Steel Frame
- Chrome Finish
- Cafe 4-Leg Standard Glides: Marquis Nylon Swivel
- Cafe 4-Leg Optional Glides: Marquis Steel Swivel, Marquis Neoprene Swivel, Felt Snap-On, Q-Ball or Quiet Glide
- Cafe Cantilever Standard Glides: Floor-Friendly
- Option: CAL 133 Compliant

Model	Size	Wt. (lbs)	Freight Class
C-SM-CAFE-30	Senior: 30"	18.2	150
C-SM-CAFE-24	Senior: 24"	17	150
C-SM-CAFE-CANT-30	Senior: 30"	24.5	150
C-SM-CAFE-CANT-24	Senior: 24"	23	150

Cafe Height Material Selector

Polypropylene Shell

- Black
- Charcoal
- Graphite
- Chocolate
- Pumpkin
- Yellow
- Sunburst
- Hunter Green
- Apple Green
- Navy Blue
- Royal Blue
- Sky Blue
- Plum
- Burgundy
- Crimson
- Red

Frame

- Chrome



Cantilever

The Alumni Smooth Cantilever Stacking Chair's unique leg design puts a modern twist on the classic student chair. Four leveling bumpers on the underside of the seat prevents marking and allows the chair to rest safely on work surfaces.

- Polypropylene-Molded Seat Shell
- 1" O.D. Heavily Reinforced Tubular Steel Frame
- Chrome Finish
- Standard Glides: Floor-Friendly
- Optional Glides: Stainless Steel
- Options: Book Rack (18" only), Ganging, Padded Seat, CAL 133 Compliant

Model	Size	Wt. (lbs)	Freight Class
C-SM-CANT-18	Senior: 18"	17	150
C-SM-CANT-16	Senior: 16"	17	150
C-SM-CANT-14	Junior: 14"	14	150
C-SM-CANT-12	Junior: 12"	14	150

Rocker

The Alumni Air Rocker Chair's soothing rocking motion brightens the mood in any learning environment. Appropriate for students of all abilities to be utilized within reading nooks, classrooms, and side chairs.

- Polypropylene-Molded Seat Shell
- 1" O.D. Heavily Reinforced Tubular Steel Frame
- Chrome Finish
- Standard Glides: Floor-Friendly
- Option: CAL 133 Compliant
- Available in Junior and Senior Sizes



Model	Size	Wt. (lbs)	Freight Class
C-SM-ROCKER-18	Senior: 18"	18	150
C-SM-ROCKER-16	Senior: 16"	18	150
C-SM-ROCKER-14	Junior: 14"	12.5	150
C-SM-ROCKER-12	Junior: 12"	12.5	150

Cantilever and Rocker Material Selector

Polypropylene Shell

- Black
- Charcoal
- Graphite
- Chocolate
- Pumpkin
- Yellow
- Sunburst
- Hunter Green
- Apple Green
- Navy Blue
- Royal Blue
- Sky Blue
- Plum
- Burgundy
- Crimson
- Red

Frame

- Chrome

Seating Chart

4-Leg



Caster

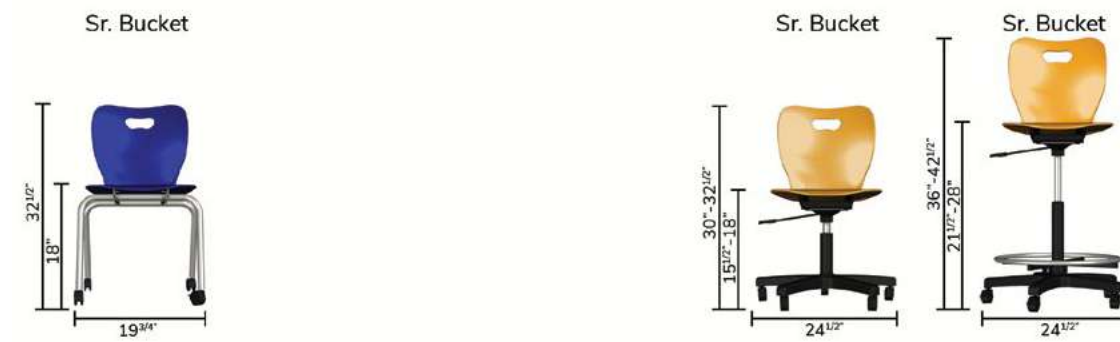

Cafe 4-Leg

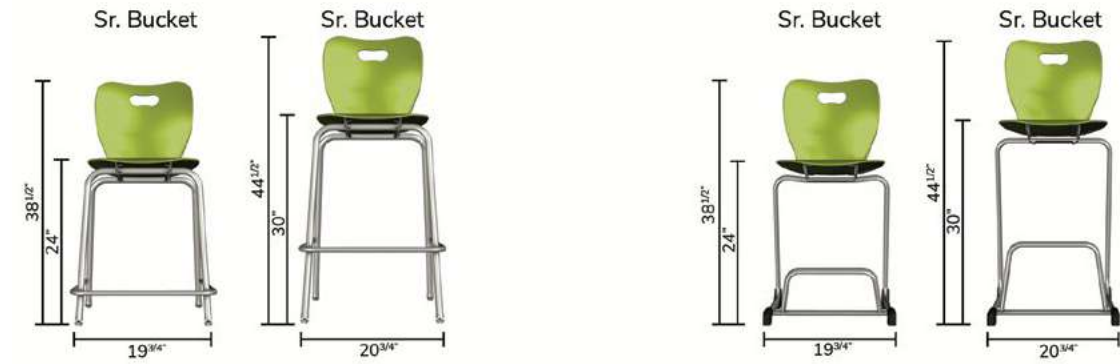

Cantilever

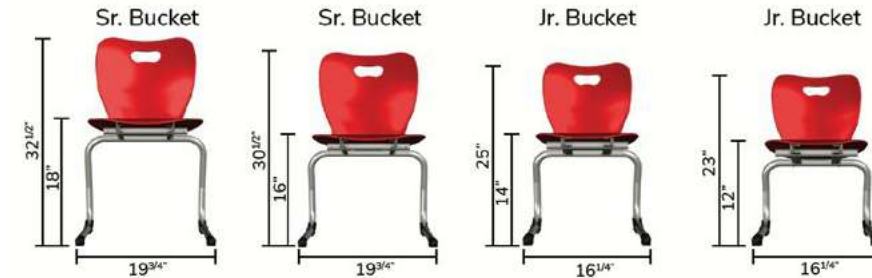

Rocker

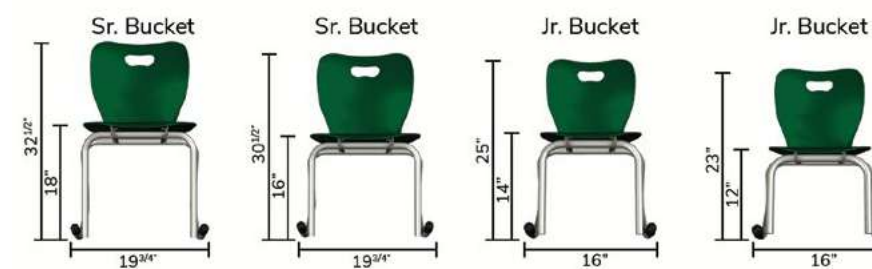

Seating Integrity



4-Leg



Caster



Task Height



Lab Height



Cafe 4-Leg



Cafe Cantilever



Cantilever



Rocker

The Integrity Chair Shell is made of a molded polypropylene with reinforcing ribs that provide proper lumbar and high back/shoulder support. Textured seat is easy to maintain and adds design flair.



Shown with optional Chrome Frame

4-Leg

The Alumni Integrity Ribbed Back 4-Leg Stacking Chair is developed for use in any learning environment. It can stack five chairs high freestanding, locking into one another when stacked for stability.

- Polypropylene-Molded Seat Shell
- 1"O.D. 16-Gauge Tubular Steel Frame
- 100% Polyester Premium Powder Coat Finish
- Standard Glides: Marquis Nylon Swivel
- Optional Glides: Marquis Steel Swivel, Marquis Neoprene Swivel, Felt Snap-On, Q-Ball or Quiet Glide
- Options: Chrome Frame, Book Rack (18" only), Music Pitch (18" only), Ganging, Padded Seat, CAL 133 Compliant

Model	Size	Wt. (lbs)	Freight Class
C-INT-18	Senior: 18"	17	150
C-INT-16	Senior: 16"	17	150
C-INT-14	Junior: 14"	14	150
C-INT-12	Junior: 12"	14	150



Shown with optional Chrome Frame

Caster

The Alumni Integrity Ribbed Back Caster Chair's dual wheel system encourages flexibility in any environment, allowing for quick and easy changes to classroom configurations throughout the day.

- Polypropylene-Molded Seat Shell
- 1"O.D. 16-Gauge Tubular Steel Frame
- 100% Polyester Premium Powder Coat Finish
- Standard Casters: Dual Wheel Urethane Caster
- Options: Chrome Frame, Padded Seat, CAL 133 Compliant

Model	Size	Wt. (lbs)	Freight Class
C-INT-CA-18	Senior: 18"	19	150

4-Leg and Caster Material Selector

Polypropylene Shell

- Black
- Charcoal
- Graphite
- Chocolate
- Pumpkin
- Yellow
- Sunburst
- Hunter Green
- Apple Green
- Navy Blue
- Royal Blue
- Sky Blue
- Plum
- Burgundy
- Crimson
- Red

Frame

- Black
- Hammettone Black
- Hammettone Gray
- Dark Gray
- Gray
- Metallic
- Chrome
- Beige
- Hunter Green
- Navy Blue
- Burgundy



Task Height



Lab Height

Task Height Gas Lift (GL): Provides comfortable seating for Computer Labs and Training Rooms.

Lab Height Gas Lift with Foot Ring (GLR): Provides comfortable seating for the Arts and Sciences. Convenient integral chrome foot ring is included for extra comfort.

- Polypropylene-Molded Seat Shell
- Black Molded Nylon Frame
- Standard Casters: Dual Wheel Urethane Caster
- Options: Fixed Glides, Padded Seat, CAL 133 Compliant

Model	Size	Wt. (lbs)	Freight Class
C-INT-GL	Senior: 15.5"-18"	18.2	KD 70
C-INT-GLR	Senior: 21.5"-28.25"	22.6	KD 70

Task and Lab Height Material Selector

Polypropylene Shell

- Black
- Charcoal
- Graphite
- Chocolate
- Pumpkin
- Yellow
- Sunburst
- Hunter Green
- Apple Green
- Navy Blue
- Royal Blue
- Sky Blue
- Plum
- Burgundy
- Crimson
- Red





Cafe 4-Leg



Cafe Cantilever

Cafe Height 4-Leg Chair (CAFE): Developed for use in any learning environment and stacks four high for easy storage.

Cafe Height Cantilever Chair (CAFE-CANT): Designed with a contemporary cantilever-style base stool with heavy gauge oval tubing that creates a fresh and modern look.

- Polypropylene-Molded Seat Shell
- Heavy Gauge Tubular Steel Frame
- Chrome Finish
- Cafe Cantilever Standard Glides: Floor-Friendly
- Cafe 4-Leg Standard Glides: Marquis Nylon Swivel
- Cafe 4-Leg Optional Glides: Marquis Steel Swivel, Marquis Neoprene Swivel, Felt Snap-On, Q-Ball or Quiet Glide
- Option: CAL 133 Compliant

Model	Size	Wt. (lbs)	Freight Class
C-INT-CAFE-30	Senior: 30"	20.2	150
C-INT-CAFE-24	Senior: 24"	19	150
C-INT-CAFE-CANT-30	Senior: 30"	24.5	150
C-INT-CAFE-CANT-24	Senior: 24"	23	150

Cafe Height Material Selector

Polypropylene Shell

- Black
- Charcoal
- Graphite
- Chocolate
- Pumpkin
- Yellow
- Sunburst
- Hunter Green
- Apple Green
- Navy Blue
- Royal Blue
- Sky Blue
- Plum
- Burgundy
- Crimson
- Red

Frame

- Chrome



Cantilever

The Alumni Integrity Cantilever Stacking Chair's unique leg design puts a modern twist on the classic student chair. Four leveling bumpers on the underside of the seat prevents marking and allows the chair to rest safely on work surfaces.

- Polypropylene-Molded Seat Shell
- 1" O.D. Heavily Reinforced Tubular Steel Frame
- Chrome Finish
- Standard Glides: Floor-Friendly Glide
- Optional Glides: Stainless Steel Glide
- Options: Book Rack (18" only), Ganging, Padded Seat, CAL 133 Compliant

Model	Size	Wt. (lbs)	Freight Class
C-INT-CANT-18	Senior: 18"	18	150
C-INT-CANT-16	Senior: 16"	17	150
C-INT-CANT-14	Junior: 14"	12	150
C-INT-CANT-12	Junior: 12"	11	150

Rocker

The Alumni Air Rocker Chair's soothing rocking motion brightens the mood in any learning environment. Appropriate for students of all abilities to be utilized within reading nooks, classrooms, and side chairs.

- Polypropylene-Molded Seat Shell
- 1" O.D. Heavily Reinforced Tubular Steel Frame
- Chrome Finish
- Standard Glides: Floor-Friendly
- Option: CAL 133 Compliant



Model	Size	Wt. (lbs)	Freight Class
C-INT-ROCKER-18	Senior: 18"	20	150
C-INT-ROCKER-16	Senior: 16"	20	150
C-INT-ROCKER-14	Junior: 14"	12	150
C-INT-ROCKER-12	Junior: 12"	12	150

Cantilever and Rocker Material Selector

Polypropylene Shell

- Black
- Charcoal
- Graphite
- Chocolate
- Pumpkin
- Yellow
- Sunburst
- Hunter Green
- Apple Green
- Navy Blue
- Royal Blue
- Sky Blue
- Plum
- Burgundy
- Crimson
- Red

Frame

- Chrome



Seating Chart

4-Leg



Caster

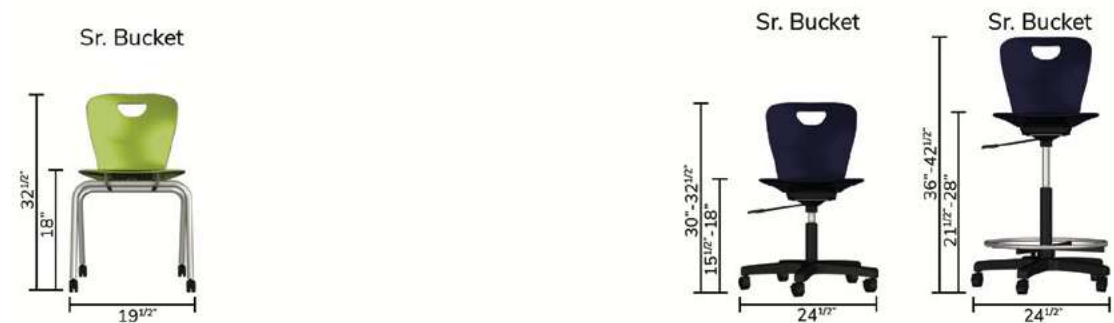

Cafe 4-Leg

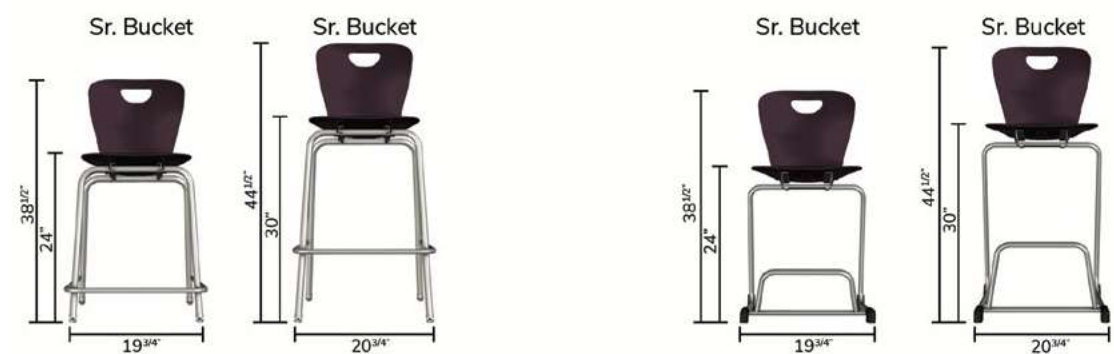

Cantilever

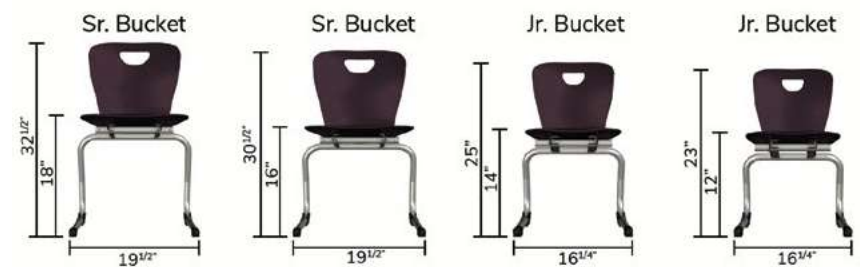

Rocker

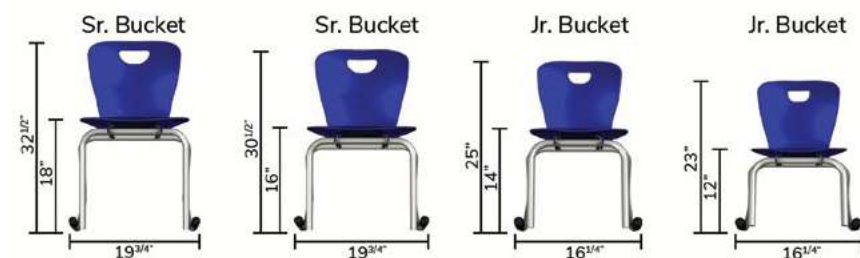

Seating Classic



4-Leg



Caster



Task Height



Lab Height

The Classic Chair Shell is built with extra thick polypropylene for added durability and extra comfort.



Shown with optional Chrome Frame and Marquis Swivel Glide

4-Leg

The Alumni Classic 4-Leg Stacking Chair is developed for use in any learning environment. It can stack ten chairs high freestanding, locking into one another when stacked for stability.

- Extra Thick Polypropylene Seat Shell
- 1 1/8" O.D. 18-Gauge Steel Frame
- 100% Polyester Premium Powder Coat Finish
- Standard Glides: Vinyl Insert
- Optional Glides: Marquis Nylon Swivel, Marquis Steel Swivel, Marquis Neoprene Swivel, Felt Snap-On, Q-Ball or Quiet Glide
- Options: Chrome Frame, Book Rack (18" only), Music Pitch (18" only) Ganging, Padded Seat, CAL 133 Compliant

Model	Size	Wt. (lbs)	Freight Class
C-CLASS-18	Senior: 18"	11	150
C-CLASS-16	Senior: 16"	11	150
C-CLASS-14	Junior: 14"	9.6	150
C-CLASS-12	Junior: 12"	9.6	150



Shown with optional Chrome Frame

Caster

The Alumni Classic Caster Chair's dual wheel system encourages flexibility in any environment, allowing for quick and easy changes to classroom configurations throughout the day.

- Extra Thick Polypropylene Seat Shell
- 1 1/8" O.D. Heavily Reinforced Tubular Steel Frame
- 100% Polyester Premium Powder Coat Finish
- Standard Casters: Dual Wheel Urethane Caster
- Options: Chrome Frame, Padded Seat, CAL 133 Compliant

Model	Size	Wt. (lbs)	Freight Class
C-CLASS-CA-18	Senior: 18"	13	150

4-Leg and Caster Material Selector

Polypropylene Shell

- Black
- Charcoal
- Graphite
- Chocolate
- Pumpkin
- Yellow
- Sunburst
- Hunter Green
- Apple Green
- Navy Blue
- Royal Blue
- Sky Blue
- Plum
- Burgundy
- Crimson
- Red

Frame

- Black
- Hammettone Black
- Hammettone Gray
- Dark Gray
- Gray
- Metallic
- Chrome
- Beige
- Hunter Green
- Navy Blue
- Burgundy



Task Height



Lab Height

Task Height Gas Lift (GL): Provides comfortable seating for Computer Labs and Training Rooms.

Lab Height Gas Lift with Foot Ring (GLR): Provides comfortable seating for the Arts and Sciences. Convenient integral chrome foot ring is included for extra comfort.

- Extra Thick Polypropylene Seat Shell
- Black Molded Nylon Frame
- Standard Casters: Dual Wheel Urethane Caster
- Options: Fixed Glides, Padded Seat, CAL 133 Compliant

Model	Size	Wt. (lbs)	Freight Class
C-CLASS-GL	Senior: 16"-19.5"	15.6	KD 70
C-CLASS-GLR	Senior: 20.5"-27.75"	19	KD 70

Task and Lab Height Material Selector

Polypropylene Shell

- Black
- Charcoal
- Graphite
- Chocolate
- Pumpkin
- Yellow
- Sunburst
- Hunter Green
- Apple Green
- Navy Blue
- Royal Blue
- Sky Blue
- Plum
- Burgundy
- Crimson
- Red



Seating Chart

4-Leg

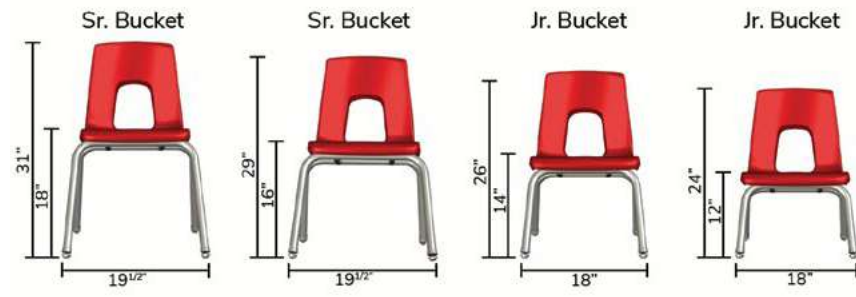

Caster



Task Height



Lab Height



Seating Honor Roll



4-Leg



Caster



Task Height



Lab Height



Fixed Tablet Arm



Flip Tablet Arm



Hardwood Stool



Hard Plastic Stool

The Honor Roll Chair Shell is built with extra thick polypropylene for added durability and lumbar support. A completely smooth back surface makes cleaning and maintenance a breeze.



Shown with optional Chrome Frame and Marquis Swivel Glide

4-Leg

The Alumni Honor Roll 4-Leg Stacking Chair is developed for use in any learning environment. It is the only chair on the market that can stack fifteen chairs high freestanding, locking into one another when stacked for stability.

- Extra Thick Polypropylene Seat Shell
- 1" O.D. Heavily Reinforced 16-Gauge Tubular Steel Frame
- 100% Polyester Premium Powder Coat Finish
- Standard Glides: Vinyl Insert
- Optional Glides: Marquis Nylon Swivel, Marquis Steel Swivel, Marquis Neoprene Swivel, Felt Snap-On, Q-Ball or Quiet Glide
- Options: Chrome Frame, Book Rack (18" only), Music Pitch (18" only) Ganging, Padded Seat and/or Back, CAL 133 Compliant

Model	Size	Wt. (lbs)	Freight Class
C-HR1800-18	Senior: 18"	10.7	150
C-HR1800-16	Senior: 16"	10.7	150
C-HR1800-14	Junior: 14"	8.9	150
C-HR1800-12	Junior: 12"	8.9	150



Caster

The Alumni Honor Roll Caster Chair's dual wheel system encourages flexibility in any environment, allowing for quick and easy changes to classroom configurations throughout the day.

- Extra Thick Polypropylene Seat Shell
- 1" O.D. Heavily Reinforced Tubular Steel Frame
- 100% Polyester Premium Powder Coat Finish
- Standard Casters: Dual Wheel Urethane Caster
- Options: Chrome Frame, Padded Seat and/or Back, CAL 133 Compliant

Model	Size	Wt. (lbs)	Freight Class
C-HR1800-CA-18	Senior: 18"	12.7	150

4-Leg and Caster Material Selector

Polypropylene Shell

- Black
- Charcoal
- Graphite
- Chocolate
- Pumpkin
- Yellow
- Sunburst
- Hunter Green
- Apple Green
- Navy Blue
- Royal Blue
- Sky Blue
- Plum
- Burgundy
- Crimson
- Red

Frame

- Black
- Hammettone Black
- Hammettone Gray
- Dark Gray
- Gray
- Metallic
- Chrome
- Beige
- Hunter Green
- Navy Blue
- Burgundy



Task Height



Lab Height

Task Height Gas Lift (GL): Provides comfortable seating for Computer Labs and Training Rooms.

Lab Height Gas Lift with Foot Ring (GLR): Provides comfortable seating for the Arts and Sciences. Convenient integral chrome foot ring is included for extra comfort.

- Extra Thick Polypropylene Seat Shell
- Black Molded Nylon Base
- Standard Casters: Dual Wheel Urethane Caster
- Options: Fixed Glides, Padded Seat and/or Back, CAL 133 Compliant

Model	Size	Wt. (lbs)	Freight Class
C-HR1800-GL	Senior: 15.25"-18.5"	16	KD 70
C-HR1800-GLR	Senior: 20"-27"	19	KD 70

Task and Lab Height Material Selector

Polypropylene Shell

- Black
- Charcoal
- Graphite
- Chocolate
- Pumpkin
- Yellow
- Sunburst
- Hunter Green
- Apple Green
- Navy Blue
- Royal Blue
- Sky Blue
- Plum
- Burgundy
- Crimson
- Red





Fixed Tablet Arm

Flip Tablet Arm

Fixed Arm Chair: The Alumni Honor Roll Fixed Tablet Chair provides a space saving solution for classrooms.

Flip Arm Chair: The Alumni Honor Roll Flip Tablet Chair provides a space saving solution for classrooms. It's articulating work surface makes it easy for students to get in and out of the chair.

- Standard Plastic Laminate Top with Round Corner PVC Edge or Hard Plastic (On Fixed Tablet Only)
- Standard Glides: Marquis Nylon Swivel
- Optional Glides: Marquis Steel Swivel, Marquis Neoprene Swivel, Felt Snap-On, Q-Ball or Quiet Glide

Fixed Tablet Material Selector

Polypropylene Shell

- Black
- Charcoal
- Graphite
- Chocolate
- Pumpkin
- Yellow
- Sunburst
- Hunter Green
- Apple Green
- Navy Blue
- Royal Blue
- Sky Blue
- Plum
- Burgundy
- Crimson
- Red

Hard Plastic Top

- Dark Walnut
- Mahogany
- Wild Cherry
- Bannister Oak
- Loft Oak
- Golden Oak
- New Age Oak
- Sugar Maple
- Beige Sand
- Cosmic Strandz
- Gray Spectrum
- Gray Sand
- High Rise
- Vapor Strandz
- Sprout Green
- Agave Blue
- Eggplant Purple
- Pomegranate Red

Laminate Top

- Dark Walnut
- Mahogany
- Wild Cherry
- Bannister Oak
- Loft Oak
- New Age Oak
- Sugar Maple
- Cosmic Strandz
- Gray Spectrum
- High Rise
- Vapor Strandz
- Sprout Green
- Agave Blue
- Eggplant Purple
- Pomegranate Red
- Primary Yellow
- Primary Green
- Primary Blue
- Primary Red

PVC Edge

- Black
- Charcoal
- Warm Gray
- Gray
- Maple
- Beige
- Pumpkin
- Primary Yellow
- Primary Green
- Apple Green
- Navy Blue
- Primary Blue
- Sky Blue
- Plum
- Crimson
- Primary Red

Frame

- Black
- Hammertone Black
- Hammertone Gray
- Dark Gray
- Gray
- Metallic
- Chrome
- Beige
- Hunter Green
- Navy Blue
- Burgundy

Model	Size	Wt. (lbs)	Freight Class
C-HR1800-18-TA	Senior: 18"	27	250
C-HR1800-18-TA-FLIP	Senior: 18"	32	250



Hardwood Stool

Hard Plastic Stool

The Alumni Honor Roll Hardwood (HW) or Hard Plastic (HP) Stools have a 12" diameter surface made of hardwood or hard plastic respectively. These stools are a perfect addition to any Science Lab, Art Room or Classroom. They both feature a foot ring welded to the exterior of the legs for maximum stability and comfort.

- 12" Diameter Seat, Birch Plywood or Hard Plastic
- 1 1/8" O.D. 18-Gauge with 1" O.D. 16-Gauge Chrome Adjustable Inserts, Adjustable Height 18"-28"
- Chrome Finish
- Standard Glides: Vinyl Insert
- Optional Glides: Marquis Nylon Swivel, Marquis Neoprene Swivel, Marquis Steel Swivel, Felt Snap-On, Q-Ball or Quiet Glide
- Options: Fixed Heights (18", 20", 22", 24", 26", 28", 30")

Model	Size	Wt. (lbs)	Freight Class
S-HW	12" DIA: 18"-28"	12	150
S-HP	12" DIA: 18"-28"	14.2	150

Honor Roll Stool Material Selector

Hard Plastic Seat

- Black
- Charcoal
- Gray
- Hunter Green
- Navy Blue
- Royal Blue
- Burgundy
- Cranberry

Hardwood Seat

- Natural Birch

Frame

- Chrome



Seating Chart





4-Leg

The Alumni Marquis 4-Leg Stacking Chair is developed for use in any learning environment.

- Hard Plastic Seat and Backrest
- 1" O.D. Heavy Gauge Tubular Steel Frame
- Chrome Finish
- Standard Glides: Marquis Nylon Swivel Glide
- Optional Glides: Marquis Steel Swivel, Marquis Neoprene Swivel, Felt Snap-On, Q-Ball or Quiet Glide
- Options: Book Rack (18" only), Ganging

Model	Size	Wt. (lbs)	Freight Class
C-MAR-18	Senior: 18"	19.5	150
C-MAR-16	Senior: 16"	19.5	150
C-MAR-14	Junior: 14"	14	150
C-MAR-12	Junior: 12"	14	150



4-Leg with Handle

The Alumni Marquis 4-Leg Stacking Chair with Handle is developed for use in any learning environment. Built-in handle allows for ease of movement.

- Hard Plastic Seat and Backrest
- 1" O.D. Heavy Gauge Tubular Steel Frame
- Chrome Finish
- Standard Glides: Marquis Nylon Swivel
- Optional Glides: Marquis Steel Swivel, Marquis Neoprene Swivel, Felt Snap-On, Q-Ball or Quiet Glide
- Options: Book Rack (18" only), Ganging

Model	Size	Wt. (lbs)	Freight Class
C-MAR-H-18	Senior: 18"	19.5	150
C-MAR-H-16	Senior: 16"	19.5	150
C-MAR-H-14	Junior: 14"	14	150
C-MAR-H-12	Junior: 12"	14	150

4-Leg Material Selector

Hard Plastic Seat & Back

- Black
- Charcoal
- Gray
- Hunter Green
- Navy Blue
- Royal Blue
- Burgundy
- Cranberry

Frame

- Chrome



Task Height



Lab Height

Task Height Gas Lift (GL): Provides comfortable seating for Computer Labs and Training Rooms.

Lab Height Gas Lift with Foot Ring (GLR): Provides comfortable seating for the Arts and Sciences. Convenient integral chrome foot ring is included for extra comfort.

- Hard Plastic Seat and Backrest
- Black Molded Nylon Base
- Standard Casters: Dual Wheel Urethane Caster
- Options: Fixed Glides

Model	Size	Wt. (lbs)	Freight Class
C-MAR-GL	Senior: 15"-19"	24	KD 70
C-MAR-GLR	Senior: 20"-27"	27	KD 70

Task and Lab Height Material Selector

Hard Plastic Seat & Back

- Black
- Charcoal
- Gray
- Hunter Green
- Navy Blue
- Royal Blue
- Burgundy
- Cranberry

Frame

- Chrome



Seating Chart

4-Leg

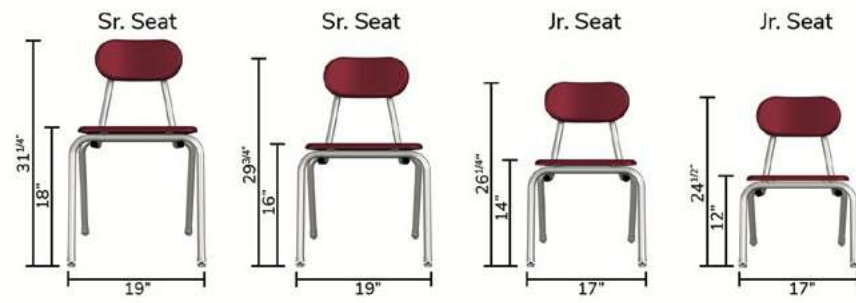

4-Leg with Handle

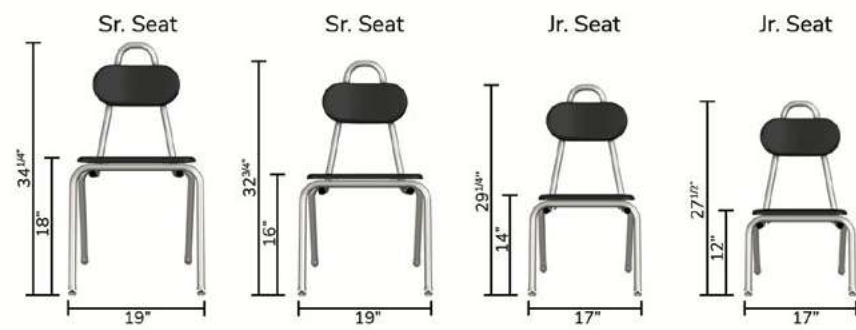

Task Height



Lab Height

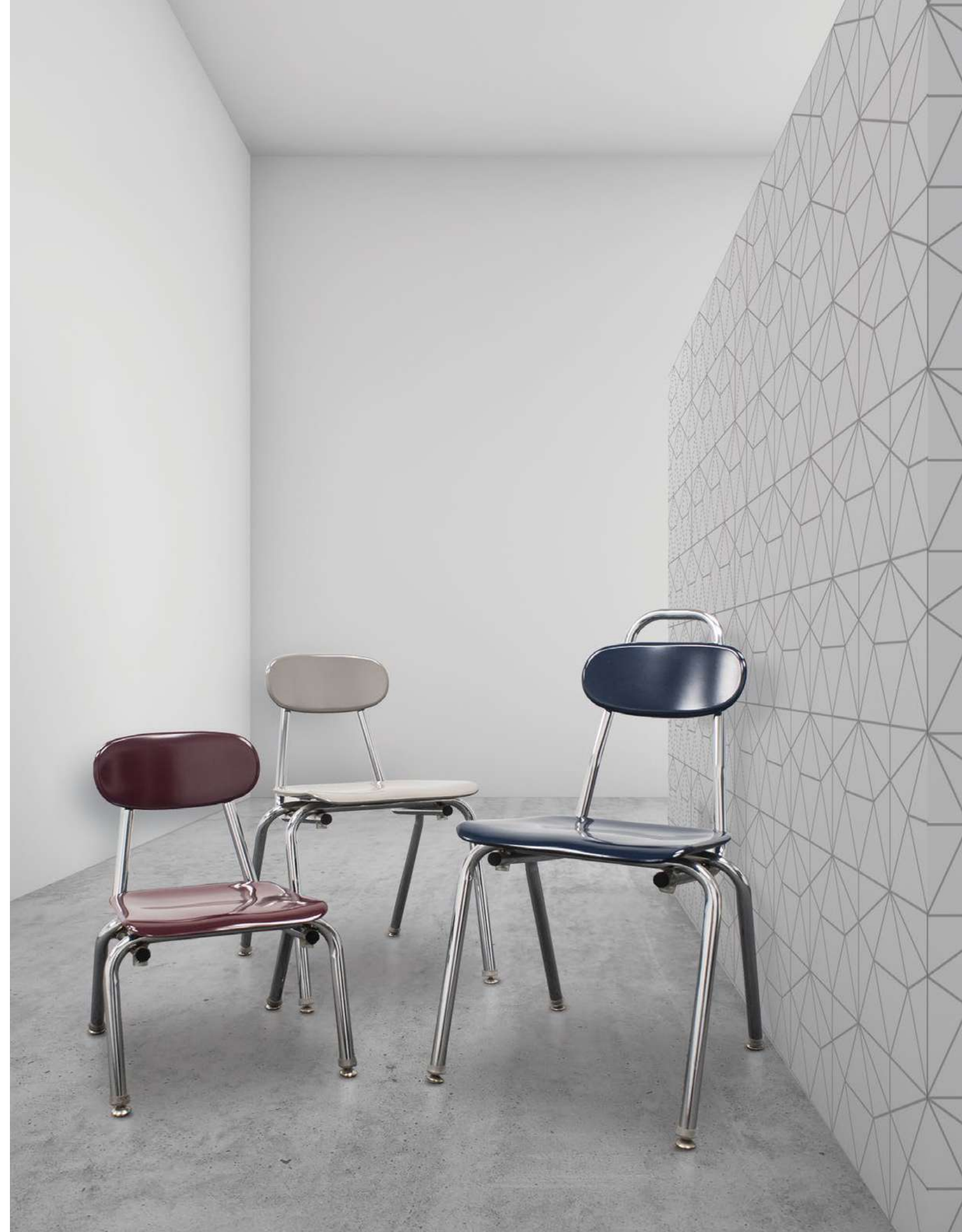



Balance Stool

The Alumni Balance Stool is an adaptive style of seating that encourages engaged student learning positions. This setup promotes in-class motivation by providing a refreshing learning environment for the user. It comes in two sizes that are adjustable in height; small 15"-19" and large 21"-26". Both sizes are highlighted by the brightly colored padded seat. The 13" diameter ensures equivalent proportions leaving students with a unique and satisfying seating experience.



Model	Size	Wt. (lbs)	Freight Class
S-BAL-WH-WIN-AD	15"-19"	11	150
S-BAL-TALL-WH-VIN-AD	21"-26"	13	150



Balance Stool Material Selector

Padded Seat Fabric

- Graphite
- Apple Green
- Blue
- Red



MSWS-ST-FX30



MSWS-ST-FX24

Makerspace Works Steel Stool

The Alumni Makerspace Works Steel Stool is a modern take on the classic stool while providing a sturdy seating option. These stools are compact and stackable for the ease of storing and saving space. Cross bracing adds extra strength and durability. The 24" and 30" sizes are equipped with footrests.

Model	Size	Wt. (lbs)	Freight Class
MSWS-ST-FX18	18"	7	150
MSWS-ST-FX24	24"	15	150
MSWS-ST-FX30	30"	23	150



Shown with the Makerspace Works Block Table



MSWS-ST-FX18

Steel Stool Material Selector

Frame

- Metallic
- Pumpkin
- Plum
- Apple Green
- Ocean Blue





Cylinder

Crescent

Flow

Pente

Mobile Series Pods

The Alumni Mobile Seating Pods allow teachers the ability to enhance the 21st Century learning environment with imaginative educational spaces. They come standard with adjustable glides to create a sturdy base on any floor. The Cylinder and Crescent Pods are a 14" diameter surface, they can be used on their own or in combination with one another. The Flow and Pente Pods are designed to correlate with our most popular y5 desk shapes; these can be arranged in similar configurations as the desks. The D Shape Pod is designed as a comfortable lowered seating option for both classroom or library settings.

- Grade 1 Fabric Standard
- Available Grades of Fabric 1 and 2
- Standard Glides: Fixed (Not available on D Shape)
- Available fabrics are Spradling: Silvertex, Zander, Scribe and Interlace
- Fixed Height 18" (Cylinder, Crescent, Flow, Pente)
- Fixed Height 3" (D Shape)

Model	Size	Wt. (lbs)	Freight Class
AF-P-CYL14R-FX18	14" DIA	8	400
AF-P-CRES14R-FX18	14" DIA	8	400
AF-P-FLOW2527-FX18	25"x27"	18	400
AF-P-PENTE252531-FX18	28"x36"	20	400
AF-P-DSHAPE16-FX3	16" DIA	5	400

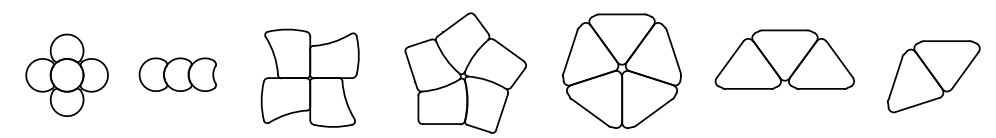

Chair

Loveseat

Armless Series

The Alumni Armless Series is a stylish seating alternative for enhancing learning commons and breakout spaces. They come standard with adjustable glides to create a sturdy base on any floor. The armless soft seating options bring color and comfort to any environment, contrasting with formal desks, tables and chairs which may already occupy the space. The armless series are open and inviting for casual conversations or to simply read and get work done.

- Grade 1 Fabric Standard
- Available Grades of Fabric 1 and 2
- Standard Glide: Fixed
- Available fabrics are Spradling: Silvertex, Zander, Scribe and Interlace
- Fixed Height 18"

Model	Size	Wt. (lbs)	Freight Class
AF-ALB-C2231-FX18	22"x31"x35"	35	400
AF-ALB-LS3145-FX18	45"x31"x35"	60	400
AL-ALB-SF3167-FX18	67"x31"x35"	70	400
AF-AL-SQBEN3031-FX18	31"x31"x18"	30	400
AF-ALB-A60INSF3167	67"x31"x35"	75	400
AF-ALB-A60OUTSF3167-FX18	67"x31"x35"	75	400
AF-AL-A60BEN3167-FX18	67"x31"x18"	40	400

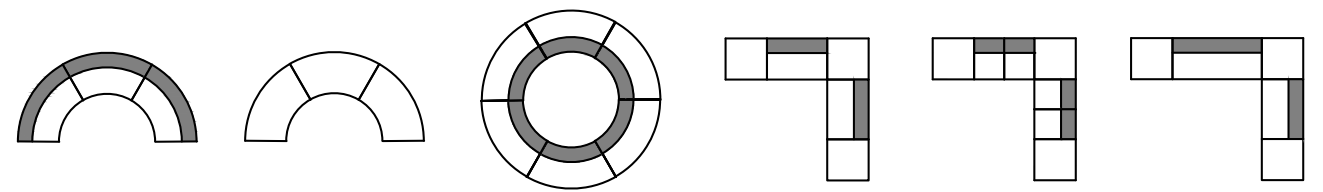

Desks



Our variety of progressive and traditional desk designs provide teachers with the ability to configure their classroom to support various learning styles.



Desks



Flow



Pente



Idea



Flow Desk

The Ideal Group Size for Collaborative Learning

The Alumni Flow Desk was developed for traditional and progressive teaching styles to help implement 21st Century Learning concepts into the classroom. Optional casters make these desks easy to pull apart for individual study and testing purposes, or to move into multiple group configurations. In its ideal group configuration of 5, it can be rearranged to maximize the use of limited space commonly observed in today's classrooms. Full-frame construction takes the wiggle out of learning.

- Hard Plastic (HP) Top or 3/4" or 1 1/8" High Pressure Laminate (HPL) Top with PVC Edge
- Fully welded table frame and leg assembly made of full perimeter 3/4" steel tubing welded to four 1 1/2" leg mounts designed to accept 1 1/8" O.D. round steel upper tube with inner round telescoping tube, adjustable height 22"-30"
- 100" Polyester Premium Powder Coat Finish
- Standard Glides: Marquis Nylon Swivel
- Optional Glides: Marquis Neoprene Swivel, Marquis Steel Swivel, Felt Snap-On, Q-Ball or Quiet Glide
- Options: Bag Hooks, Fixed Height, Solid or Perforated Steel Pass-Through Book Box, Pass-Through Wire Shelf, Tote Tray Housing, Two Legs with 2" Dual Wheel Locking Caster, ADA Height (26"-34"), or Standing Height (34"-42")



T-FLOW
Shown with Alumni Explorer
4-Leg Chair and
optional Casters



T-FLOW-BB
Shown with optional Casters and Book
Box



T-FLOW
Shown with optional Casters



FLOW CONFIGURATIONS

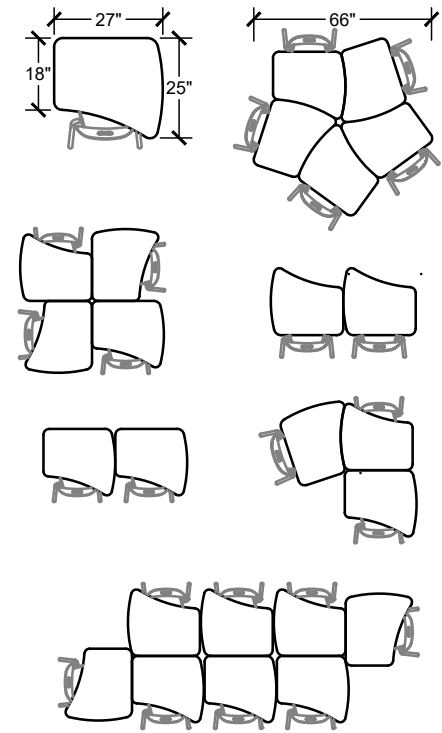

Model	Top Size	Wt. (lbs)	Freight Class
T-FLOW	25"x27"x18"	33	KD 70
T-FLOW-BB	25"x27"x18"	38	KD 70
T-FLOW-WS	25"x27"x18"	37	KD 70
T-FLOW-PERF	25"x27"x18"	37	KD 70

Flow Desk Material Selector

Hard Plastic Top

- Dark Walnut
- Mahogany
- Wild Cherry
- Bannister Oak
- Loft Oak
- Golden Oak
- New Age Oak
- Sugar Maple
- Beige Sand
- Cosmic Strandz
- Gray Spectrum
- Gray Sand
- High Rise
- Vapour Strandz
- Sprout Green
- Agave Blue
- Eggplant Purple
- Pomegranate Red

Laminate Top

- Dark Walnut
- Mahogany
- Wild Cherry
- Bannister Oak
- Loft Oak
- New Age Oak
- Sugar Maple
- Cosmic Strandz
- Gray Spectrum
- High Rise
- Vapour Strandz
- Sprout Green
- Agave Blue
- Eggplant Purple
- Pomegranate Red
- Primary Yellow
- Primary Green
- Primary Blue
- Primary Red

PVC Edge

- Black
- Charcoal
- Warm Gray
- Gray
- Maple
- Beige
- Pumpkin
- Primary Yellow
- Primary Green
- Apple Green
- Navy Blue
- Primary Blue
- Sky Blue
- Plum
- Crimson
- Primary Red

Frame

- Black
- Hammertone Black
- Hammertone Gray
- Dark Gray
- Gray
- Metallic
- Beige
- Hunter Green
- Navy Blue
- Burgundy



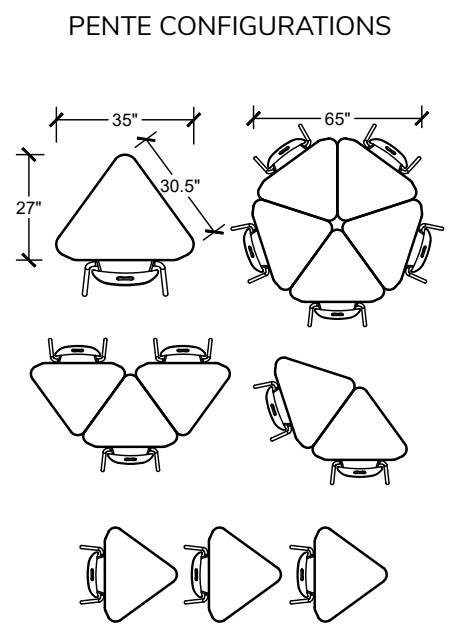

Pente Desk

A Familiar Shape with a Unique Application

The Alumni Pente Desk was designed to increase collaboration through the y5 approach while utilizing a familiar triangular shape. Optional casters make these desks easy to pull apart for individual study and testing purposes, or to move into multiple group configurations. In its ideal group configuration of 5, it can be rearranged to maximize the use of limited space commonly observed in today's classrooms.

- Hard Plastic (HP) Top with Embossed Pencil Groove or 3/4" or 1 1/8" High Pressure Laminate (HPL) Top with PVC Edge
- Fully welded table frame and leg assembly made of full perimeter 3/4" steel tubing welded to three 1 1/2" leg mounts designed to accept a 1 1/8" O.D. round steel upper tube with inner round telescoping tube, adjustable height 22"-30"
- 100% Polyester Premium Powder Coat Finish
- Standard Glides: Marquis Nylon Swivel
- Optional Glides: Marquis Neoprene Swivel, Marquis Steel Swivel, Felt Snap-On, Q-Ball or Quiet Glide
- Options: Bag Hook, Fixed Height, Solid or Perforated Steel Book Box, Wire Shelf, One Leg with a 2" Dual Wheel Locking Caster, ADA Height (26"-34"), or Standing Height (34"-42")



T-PENTE
Shown with Alumni Air
Cantilever Chair and
optional Caster



T-PENTE-PERF
Shown with optional Caster and
Perforated Book Box



T-PENTE-WS
Shown with optional Caster and Wire
Shelf



Pente Desk Material Selector

Hard Plastic Top

- Dark Walnut
- Mahogany
- Wild Cherry
- Bannister Oak
- Loft Oak
- Golden Oak
- New Age Oak
- Sugar Maple
- Beige Sand
- Cosmic Strandz
- Gray Spectrum
- Gray Sand
- High Rise
- Vapour Strandz
- Sprout Green
- Agave Blue
- Eggplant Purple
- Pomegranate Red

Laminate Top

- Dark Walnut
- Mahogany
- Wild Cherry
- Bannister Oak
- Loft Oak
- New Age Oak
- Sugar Maple
- Cosmic Strandz
- Gray Spectrum
- High Rise
- Vapour Strandz
- Sprout Green
- Agave Blue
- Eggplant Purple
- Pomegranate Red
- Primary Yellow
- Primary Green
- Primary Blue
- Primary Red

PVC Edge

- Black
- Charcoal
- Warm Gray
- Gray
- Maple
- Beige
- Pumpkin
- Primary Yellow
- Primary Green
- Apple Green
- Navy Blue
- Primary Blue
- Sky Blue
- Plum
- Crimson
- Primary Red

Frame

- Black
- Hammertone Black
- Hammertone Gray
- Dark Gray
- Gray
- Metallic
- Beige
- Hunter Green
- Navy Blue
- Burgundy





IDEA CONFIGURATIONS

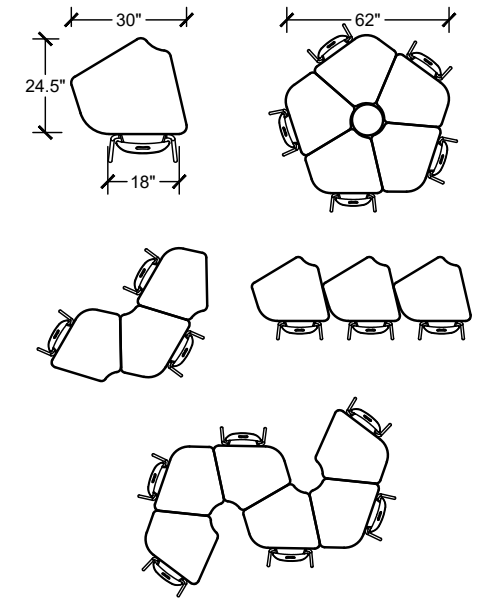

Idea Desk

Where Ideas Come Together

The Alumni Idea Desk provides a central work area for collaboration, with flexibility to offer a space in the middle for power and data capability. Optional casters make these desks easy to pull apart for individual study and testing purposes, or to move into multiple group configurations. In its ideal group configuration of 5, it can be rearranged to maximize the use of limited space commonly observed in today's classrooms.

- 3/4" or 1 1/8" High Pressure Laminate (HPL) Top with PVC Edge
- Fully welded table frame and leg assembly made of full perimeter 3/4" steel tubing welded to four 1 1/2" leg mounts designed to accept a 1 1/8" O.D. round steel upper tube with inner round telescoping tube, adjustable height 22"-30"
- 100% Polyester Premium Powder Coat Finish
- Standard Glides: Marquis Nylon Swivel
- Optional Glides: Marquis Neoprene Swivel, Marquis Steel Swivel, Felt Snap-On, Q-Ball or Quiet Glide
- Options: Bag Hook, Fixed Height, Solid or Perforated Steel Pass-Through Book Box, Pass-Through Wire Shelf, One Leg with Two 2" Dual Wheel Locking Casters, ADA Height (26"-34") or Standing Height (34"-42")



T-IDEA
Shown with Alumni Air
4-Leg Chair
and optional Casters



T-IDEA-PERF
Shown with optional Casters and
Perforated Book Box

T-IDEA
Shown with optional
Dual Wheel Casters



T-IDEA-RD
Center piece included with
each set of 5 Idea Desks

Model	Top Size	Wt. (lbs)	Freight Class
T-IDEA	33"x27"	30	KD 70
T-IDEA-BB	33"x27"	34	KD 70
T-IDEA-WS	33"x27"	33	KD 70
T-IDEA-PERF	33"x27"	34	KD 70
T-IDEA-RD	13.5" DIA	15	KD 70

Idea Desk Material Selector

Laminate Top

- Dark Walnut
- Loft Oak
- Gray Spectrum
- Agave Blue
- Primary Green
- Mahogany
- New Age Oak
- High Rise
- Eggplant Purple
- Primary Blue
- Wild Cherry
- Sugar Maple
- Vapour Strandz
- Pomegranate Red
- Primary Red
- Bannister Oak
- Cosmic Strandz
- Sprout Green
- Primary Yellow

PVC Edge

- Black
- Maple
- Primary Green
- Sky Blue
- Charcoal
- Beige
- Apple Green
- Plum
- Warm Gray
- Pumpkin
- Navy Blue
- Crimson
- Gray
- Primary Yellow
- Primary Blue
- Primary Red

Frame

- Black
- Gray
- Navy Blue
- Hammertone Black
- Metallic
- Burgundy
- Hammertone Gray
- Beige
- Dark Gray
- Hunter Green



Desks Collaborative



Boomerang



Hex



Octagon



Trap 8



Scallop



Triad



Tri 6



Chord



Integrity Standing



Ogee Breeze Student



BOOMERANG CONFIGURATIONS

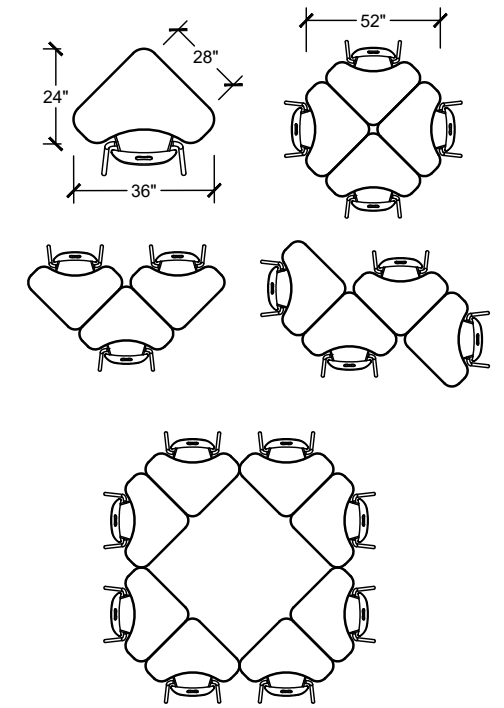

T-BOOM Center
Shown with Alumni Air 4-Leg Chair with optional Caster



T-BOOM Right-Handed Tablet Style
Shown with Alumni Air 4-Leg Chair with optional Caster



T-BOOM Left-Handed Tablet Style
Shown with Alumni Air 4-Leg Chair with optional Caster



Boomerang

The Alumni Boomerang Desk was developed for traditional and progressive teaching styles to help implement 21st Century Learning concepts into the classroom. Students can sit at the Boomerang Desk front-facing, or left or right-handed tablet style. Optional casters make these desks easy to pull apart for individual study and testing purposes, or to move into multiple group configurations. In its ideal group configuration of 4, these desks fit together snugly with no wasted space in the center and can be rearranged to maximize the use of limited space commonly observed in today's classrooms. Full-frame construction takes the wiggle out of learning.

- Hard Plastic (HP) Top with Embossed Pencil Groove or 3/4" or 1 1/8" High Pressure Laminate (HPL) Top with PVC Edge
- Fully welded table frame and leg assembly made of full perimeter 3/4" steel tubing welded to three 1 1/2" leg mounts designed to accept a 1 1/8" O.D. round steel upper tube with inner round telescoping tube, adjustable height 22"-30"
- 100% Polyester Premium Powder Coat Finish
- Standard Glides: Marquis Nylon Swivel
- Optional Glides: Marquis Neoprene Swivel, Marquis Steel Swivel, Felt Snap-On, Q-Ball or Quiet Glide
- Options: Bag Hook, Fixed Height, Solid or Perforated Steel Book Box, Wire Shelf, One Leg with a 2" Dual Wheel Locking Caster, Chrome Frame, ADA Height (26"-34"), Standing Height (34"-42"), or Standing Height with Footrest (34"-42")



T-BOOM-WS
Shown with optional Wire Shelf



T-BOOM-PERF
Shown with optional Perforated Book Box

Model	Top Size	Wt. (lbs)	Freight Class
T-BOOM	28"x28"x36"	35.4	KD 70
T-BOOM-BB	28"x28"x36"	41	KD 70
T-BOOM-WS	28"x28"x36"	40	KD 70
T-BOOM-PERF	28"x28"x36"	40	KD 70

Boomerang Material Selector

Hard Plastic Top

- Dark Walnut
- Mahogany
- Wild Cherry
- Bannister Oak
- Loft Oak
- Golden Oak
- New Age Oak
- Sugar Maple
- Beige Sand
- Cosmic Strandz
- Gray Spectrum
- Gray Sand
- High Rise
- Vapour Strandz
- Sprout Green
- Agave Blue
- Eggplant Purple
- Pomegranate Red

Laminate Top

- Dark Walnut
- Mahogany
- Wild Cherry
- Bannister Oak
- Loft Oak
- New Age Oak
- Sugar Maple
- Cosmic Strandz
- Gray Spectrum
- High Rise
- Vapour Strandz
- Sprout Green
- Agave Blue
- Eggplant Purple
- Pomegranate Red
- Primary Yellow
- Primary Green
- Primary Blue
- Primary Red

PVC Edge

- Black
- Charcoal
- Warm Gray
- Gray
- Maple
- Beige
- Pumpkin
- Primary Yellow
- Primary Green
- Apple Green
- Navy Blue
- Primary Blue
- Sky Blue
- Plum
- Crimson
- Primary Red

Frame

- Black
- Hammertone Black
- Hammertone Gray
- Dark Gray
- Gray
- Metallic
- Beige
- Hunter Green
- Navy Blue
- Burgundy





HEX CONFIGURATIONS

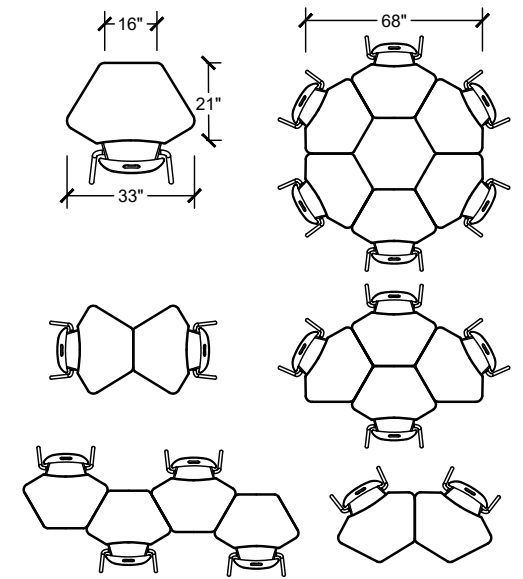

T-HEX-WS
Shown with Optional
Wire Shelf



T-HEX-PERF
Shown with Optional
Perforated Book Box

Hex

The Alumni Hex Desk was developed for traditional and progressive teaching styles to help implement 21st Century Learning concepts into the classroom. Optional casters make these desks easy to pull apart for individual study and testing purposes, or to move into multiple group configurations. In its ideal group configuration of 6, it can be rearranged to maximize the use of limited space commonly observed in today's classrooms. Full-frame construction takes the wiggle out of learning.

- Hard Plastic (HP) Top with Embossed Pencil Groove or 3/4" or 1 1/8" High Pressure Laminate (HPL) Top with PVC Edge
- Fully welded table frame and leg assembly made of full perimeter 3/4" steel tubing welded to four 1 1/2" leg mounts designed to accept 1 1/8" O.D. round steel upper tube with inner round telescoping tube, adjustable height 22"-30"
- 100% Polyester Premium Powder Coat Finish
- Standard Glides: Marquis Nylon Swivel
- Optional Glides: Marquis Neoprene Swivel, Marquis Steel Swivel, Felt Snap-On, Q-Ball or Quiet Glide
- Options: Bag Hook, Fixed Height, Solid or Perforated Steel Book Box, Wire Shelf, Two Legs with a 2" Dual Wheel Locking Casters, Chrome Frame, ADA Height (26"-34"), Standing Height (34"-42")



T-HEX



T-HEX
Shown with Optional Casters

Model	Top Size	Wt. (lbs)	Freight Class
T-HEX	21"x33"x16"	24	KD 70
T-HEX-BB	21"x33"x16"	30	KD 70
T-HEX-WS	21"x33"x16"	29	KD 70
T-HEX-PERF	21"x33"x16"	29	KD 70

Hex Material Selector

Hard Plastic Top

- Dark Walnut
- Mahogany
- Wild Cherry
- Bannister Oak
- Loft Oak
- Golden Oak
- New Age Oak
- Sugar Maple
- Beige Sand
- Cosmic Strandz
- Gray Spectrum
- Gray Sand
- High Rise
- Vapour Strandz
- Sprout Green
- Agave Blue
- Eggplant Purple
- Pomegranate Red

Laminate Top

- Dark Walnut
- Mahogany
- Wild Cherry
- Bannister Oak
- Loft Oak
- New Age Oak
- Sugar Maple
- Cosmic Strandz
- Gray Spectrum
- High Rise
- Vapour Strandz
- Sprout Green
- Agave Blue
- Eggplant Purple
- Pomegranate Red
- Primary Yellow
- Primary Green
- Primary Blue
- Primary Red

PVC Edge

- Black
- Charcoal
- Warm Gray
- Gray
- Maple
- Beige
- Pumpkin
- Primary Yellow
- Primary Green
- Apple Green
- Navy Blue
- Primary Blue
- Sky Blue
- Plum
- Crimson
- Primary Red

Frame

- Black
- Hammertone Black
- Hammertone Gray
- Dark Gray
- Gray
- Metallic
- Beige
- Hunter Green
- Navy Blue
- Burgundy





OCTAGON CONFIGURATIONS

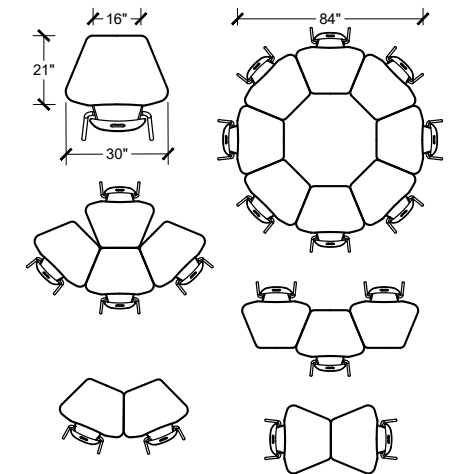

Octagon

The Alumni Octagon Desk was developed for traditional and progressive teaching styles to help implement 21st Century Learning concepts into the classroom. Optional casters make these desks easy to pull apart for individual study and testing purposes, or to move into multiple group configurations. In its ideal group configuration of 8, it can be rearranged to maximize the use of limited space commonly observed in today's classrooms. Full-frame construction takes the wiggle out of learning.

- Hard Plastic (HP) Top with Embossed Pencil Groove or 3/4" or 1 1/8" High Pressure Laminate (HPL) Top with PVC Edge
- Fully welded table frame and leg assembly made of full perimeter 3/4" steel tubing welded to four 1 1/2" leg mounts designed to accept 1 1/8" O.D. round steel upper tube with inner round telescoping tube, adjustable height 22"-30"
- 100% Polyester Premium Powder Coat Finish
- Standard Glides: Marquis Nylon Swivel
- Optional Glides: Marquis Neoprene Swivel, Marquis Steel Swivel, Felt Snap-On, Q-Ball or Quiet Glide
- Options: Bag Hook, Fixed Height, Solid or Perforated Steel Book Box, Wire Shelf, Two Legs with a 2" Dual Wheel Locking Casters, Chrome Frame, ADA Height (26"-34"), Standing Height (34"-42")



T-OCT



T-OCT
Shown with Alumni Smooth 4-Leg Chair

Model	Top Size	Wt. (lbs)	Freight Class
T-OCT-2130	21"x30"	23	KD 70
T-OCT-BB	21"x30"	29	KD 70
T-OCT-WS	21"x30"	28	KD 70
T-OCT-PERF	21"x30"	28	KD 70

Hex Material Selector

Hard Plastic Top

- Dark Walnut
- Loft Oak
- Beige Sand
- High Rise
- Eggplant Purple
- Mahogany
- Golden Oak
- Cosmic Strandz
- Vapour Strandz
- Pomegranate Red
- Wild Cherry
- New Age Oak
- Gray Spectrum
- Sprout Green
- Bannister Oak
- Sugar Maple
- Gray Sand
- Agave Blue

Laminate Top

- Dark Walnut
- Loft Oak
- Gray Spectrum
- Agave Blue
- Primary Green
- Mahogany
- New Age Oak
- High Rise
- Eggplant Purple
- Primary Blue
- Wild Cherry
- Sugar Maple
- Vapour Strandz
- Pomegranate Red
- Primary Red
- Bannister Oak
- Cosmic Strandz
- Sprout Green
- Primary Yellow

PVC Edge

- Black
- Maple
- Primary Green
- Sky Blue
- Charcoal
- Beige
- Apple Green
- Plum
- Warm Gray
- Pumpkin
- Navy Blue
- Crimson
- Gray
- Primary Yellow
- Primary Blue
- Primary Red

Frame

- Black
- Gray
- Navy Blue
- Hammertone Black
- Metallic
- Burgundy
- Hammertone Gray
- Beige
- Dark Gray
- Hunter Green





TRAP 8 CONFIGURATIONS

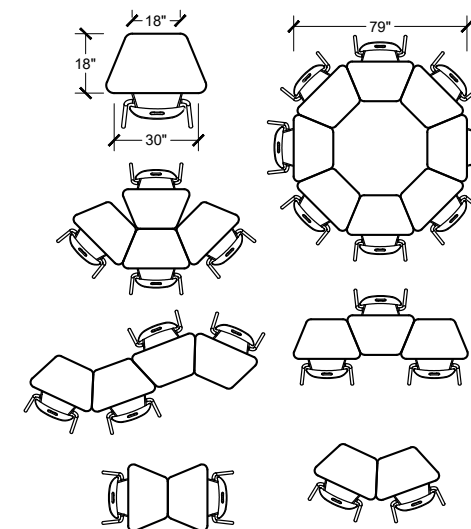

Trap 8

The Alumni Trap 8 Desk was developed for traditional and progressive teaching styles to help implement 21st Century Learning concepts into the classroom. Optional casters make these desks easy to pull apart for individual study and testing purposes, or to move into multiple group configurations. In its ideal group configuration of 8, it can be rearranged to maximize the use of limited space commonly observed in today's classrooms. Full-frame construction takes the wiggle out of learning.

- 3/4" or 1 1/8" High Pressure Laminate (HPL) Top with Round Corner PVC Edge
- Fully welded table frame and leg assembly made of full perimeter 3/4" steel tubing welded to four 1 1/2" leg mounts designed to accept 1 1/8" O.D. round steel upper tube with inner round telescoping tube, adjustable height 22"-30"
- 100% Polyester Premium Powder Coat Finish
- Standard Glides: Marquis Nylon Swivel
- Optional Glides: Marquis Neoprene Swivel, Marquis Steel Swivel, Felt Snap-On, Q-Ball or Quiet Glide
- Options: Bag Hook(s), Fixed Height, Solid or Perforated Steel Book Box, Wire Shelf, Two Legs with 2" Dual Wheel Locking Casters, ADA Height (26"-34"), Standing Height (34"-42")



T-TRAP8
Shown with optional Bag Hook



T-TRAP8-PERF
Shown with optional Perforated Book Box and Bag Hook



T-TRAP8-WS
Shown with optional Wire Shelf and Bag Hook

Model	Top Size	Wt. (lbs)	Freight Class
T-TRAP8	18"x18"x30"	29	KD 70
T-TRAP8-BB	18"x18"x30"	33	KD 70
T-TRAP8-WS	18"x18"x30"	32	KD 70
T-TRAP8-PERF	18"x18"x30"	32	KD 70

Trap 8 Material Selector

Laminate Top

- Dark Walnut, Mahogany, Wild Cherry, Bannister Oak, Loft Oak, New Age Oak, Sugar Maple, Cosmic Strandz, Gray Spectrum, High Rise, Vapour Strandz, Sprout Green, Agave Blue, Eggplant Purple, Pomegranate Red, Primary Yellow, Primary Green, Primary Blue, Primary Red

PVC Edge

- Black, Charcoal, Warm Gray, Gray, Maple, Beige, Pumpkin, Primary Yellow, Primary Green, Apple Green, Navy Blue, Primary Blue, Sky Blue, Plum, Crimson, Primary Red

Frame

- Black, Hammertone Black, Hammertone Gray, Dark Gray, Gray, Metallic, Beige, Hunter Green, Navy Blue, Burgundy





SCALLOP CONFIGURATIONS

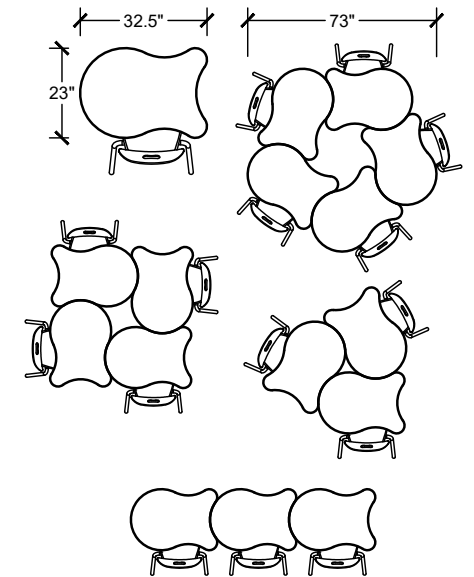

Scallop

The Alumni Scallop Desk was developed for traditional and progressive teaching styles to help implement 21st Century Learning concepts into the classroom. Optional casters make these desks easy to pull apart for individual study and testing purposes, or to move into multiple group configurations. In its ideal group configuration of 5, it can be rearranged to maximize the use of limited space commonly observed in today's classrooms.

- 3/4" or 1 1/8" High Pressure Laminate (HPL) Top with PVC Edge
- Fully welded table frame and leg assembly made of full perimeter 3/4" steel tubing welded to four 1 1/2" leg mounts designed to accept 1 1/8" O.D. round steel upper tube with inner round telescoping tube, adjustable height 22"-30"
- 100" Polyester Premium Powder Coat Finish
- Standard Glides: Marquis Nylon Swivel
- Optional Glides: Marquis Neoprene Swivel, Marquis Steel Swivel, Felt Snap-On, Q-Ball or Quiet Glide
- Options: Bag Hook, Fixed Height, Solid or Perforated Steel Pass-Through Book Box, Pass-Through Wire Shelf, Two Legs with 2" Dual Wheel Locking Caster, ADA Height (26"-34"), Standing Height (34"-42")



T-SCAL



T-SCAL
Shown with Alumni Explorer
4-Leg Chair



Model	Top Size	Wt. (lbs)	Freight Class
T-SCAL	23"x32"	31	KD 70
T-SCAL-BB	23"x32"	35	KD 70
T-SCAL-WS	23"x32"	34	KD 70
T-SCAL-PERF	23"x32"	34	KD 70

Scallop Material Selector

Hard Plastic Top

- Dark Walnut
- Mahogany
- Wild Cherry
- Bannister Oak
- Loft Oak
- Golden Oak
- New Age Oak
- Sugar Maple
- Beige Sand
- Cosmic Strandz
- Gray Spectrum
- Gray Sand
- High Rise
- Vapour Strandz
- Sprout Green
- Agave Blue
- Eggplant Purple
- Pomegranate Red

Laminate Top

- Dark Walnut
- Mahogany
- Wild Cherry
- Bannister Oak
- Loft Oak
- New Age Oak
- Sugar Maple
- Cosmic Strandz
- Gray Spectrum
- High Rise
- Vapour Strandz
- Sprout Green
- Agave Blue
- Eggplant Purple
- Pomegranate Red
- Primary Yellow
- Primary Green
- Primary Blue
- Primary Red

PVC Edge

- Black
- Charcoal
- Warm Gray
- Gray
- Maple
- Beige
- Pumpkin
- Primary Yellow
- Primary Green
- Apple Green
- Navy Blue
- Primary Blue
- Sky Blue
- Plum
- Crimson
- Primary Red

Frame

- Black
- Hammertone Black
- Hammertone Gray
- Dark Gray
- Gray
- Metallic
- Beige
- Hunter Green
- Navy Blue
- Burgundy





T-TRIAD
Shown with Alumni Smooth
4-Leg Chair

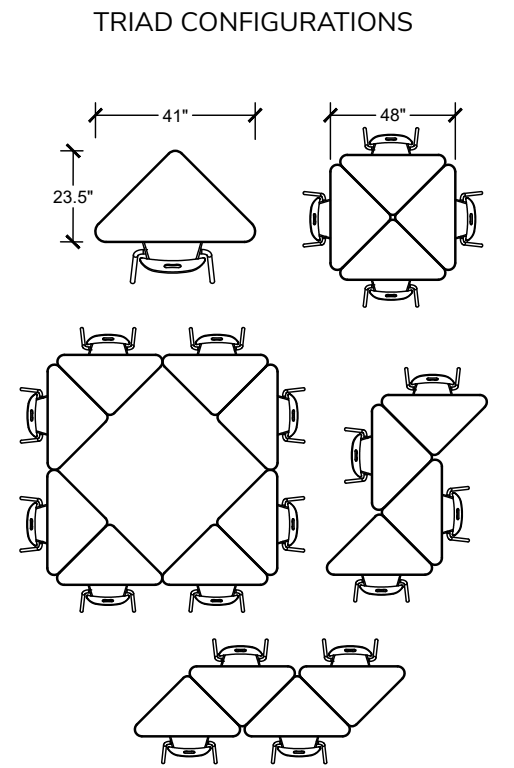

Triad

The Alumni Triad Desk was developed for traditional and progressive teaching styles to help implement 21st Century Learning concepts into the classroom. Optional casters make these desks easy to pull apart for individual study and testing purposes, or to move into multiple group configurations. In its ideal group configuration of 4, it can be rearranged to maximize the use of limited space commonly observed in today's classrooms. Full-frame construction takes the wiggle out of learning.

- 3/4" or 1 1/8" High Pressure Laminate (HPL) Top with PVC Edge
- Fully welded table frame and leg assembly made of full perimeter 3/4" steel tubing welded to three 1 1/2" leg mounts designed to accept 1 1/8" O.D. round steel upper tube with inner round telescoping tube, adjustable height 22"-30"
- 100" Polyester Premium Powder Coat Finish
- Standard Glides: Marquis Nylon Swivel
- Optional Glides: Marquis Neoprene Swivel, Marquis Steel Swivel Glide, Felt Snap-On, Q-Ball or Quiet Glide
- Options: Bag Hook, Fixed Height, Solid or Perforated Steel Book Box, Wire Shelf, One Leg with 2" Dual Wheel Locking Caster, ADA Height (26"-34"), Standing Height (34"-42")



T-TRIAD



T-TRIAD
Shown with optional
Caster



Model	Top Size	Wt. (lbs)	Freight Class
T-TRIAD	33"x33"x41"	27	KD 70
T-TRIAD-BB	33"x33"x41"	31	KD 70
T-TRIAD-WS	33"x33"x41"	30	KD 70
T-TRIAD-PERF	33"x33"x41"	30	KD 70

Triad Material Selector

Hard Plastic Top

- Dark Walnut
- Mahogany
- Wild Cherry
- Bannister Oak
- Loft Oak
- Golden Oak
- New Age Oak
- Sugar Maple
- Beige Sand
- Cosmic Strandz
- Gray Spectrum
- Gray Sand
- High Rise
- Vapour Strandz
- Sprout Green
- Agave Blue
- Eggplant Purple
- Pomegranate Red

Laminate Top

- Dark Walnut
- Mahogany
- Wild Cherry
- Bannister Oak
- Loft Oak
- New Age Oak
- Sugar Maple
- Cosmic Strandz
- Gray Spectrum
- High Rise
- Vapour Strandz
- Sprout Green
- Agave Blue
- Eggplant Purple
- Pomegranate Red
- Primary Yellow
- Primary Green
- Primary Blue
- Primary Red

PVC Edge

- Black
- Charcoal
- Warm Gray
- Gray
- Maple
- Beige
- Pumpkin
- Primary Yellow
- Primary Green
- Apple Green
- Navy Blue
- Primary Blue
- Sky Blue
- Plum
- Crimson
- Primary Red

Frame

- Black
- Hammertone Black
- Hammertone Gray
- Dark Gray
- Gray
- Metallic
- Beige
- Hunter Green
- Navy Blue
- Burgundy





Tri 6

The Alumni Tri 6 Desk was developed for traditional and progressive teaching styles to help implement 21st Century Learning concepts into the classroom. Optional casters make these desks easy to pull apart for individual study and testing purposes, or to move into multiple group configurations. In its ideal group configuration of 6, it can be rearranged to maximize the use of limited space commonly observed in today's classrooms. Full-frame construction takes the wiggle out of learning.

- 3/4" or 1 1/8" High Pressure Laminate (HPL) Top with PVC Edge
- Fully welded table frame and leg assembly made of full perimeter 3/4" steel tubing welded to three 1 1/2" leg mounts designed to accept 1 1/8" O.D. round steel upper tube with inner round telescoping tube, adjustable height 22"-30"
- 100" Polyester Premium Powder Coat Finish
- Standard Glides: Marquis Nylon Swivel
- Optional Glides: Marquis Neoprene Swivel, Marquis Steel Swivel Glide, Felt Snap-On, Q-Ball or Quiet Glide
- Options: Bag Hook, Fixed Height, Solid or Perforated Steel Book Box, Wire Shelf, One Leg with 2" Dual Wheel Locking Caster, ADA Height (26"-34"), Standing Height (34"-42")



T-TRISIX



T-TRISIX
Shown with optional
Caster



T-TRISIX
Shown with Alumni Smooth
Caster Chair



TRI 6 CONFIGURATIONS

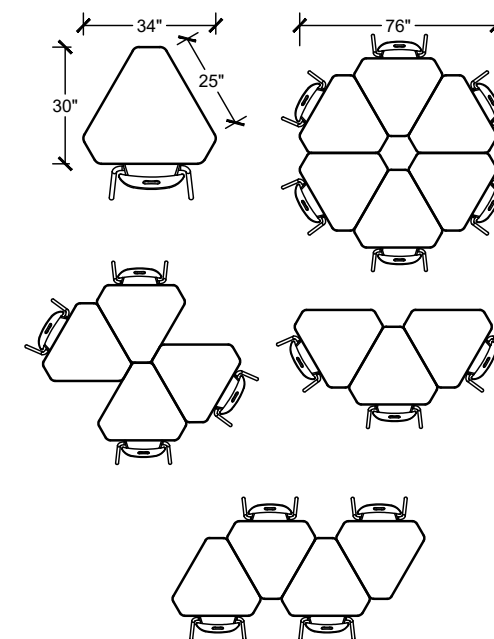

Model	Top Size	Wt. (lbs)	Freight Class
T-TRISIX	30"x30"x34"	31	KD 70
T-TRISIX-BB	30"x30"x34"	35	KD 70
T-TRISIX-WS	30"x30"x34"	34	KD 70
T-TRISIX-PERF	30"x30"x34"	34	KD 70

Tri 6 Material Selector

Hard Plastic Top

- Dark Walnut
- Mahogany
- Wild Cherry
- Bannister Oak
- Loft Oak
- Golden Oak
- New Age Oak
- Sugar Maple
- Beige Sand
- Cosmic Strandz
- Gray Spectrum
- Gray Sand
- High Rise
- Vapour Strandz
- Sprout Green
- Agave Blue
- Eggplant Purple
- Pomegranate Red

Laminate Top

- Dark Walnut
- Mahogany
- Wild Cherry
- Bannister Oak
- Loft Oak
- New Age Oak
- Sugar Maple
- Cosmic Strandz
- Gray Spectrum
- High Rise
- Vapour Strandz
- Sprout Green
- Agave Blue
- Eggplant Purple
- Pomegranate Red
- Primary Yellow
- Primary Green
- Primary Blue
- Primary Red

PVC Edge

- Black
- Charcoal
- Warm Gray
- Gray
- Maple
- Beige
- Pumpkin
- Primary Yellow
- Primary Green
- Apple Green
- Navy Blue
- Primary Blue
- Sky Blue
- Plum
- Crimson
- Primary Red

Frame

- Black
- Hammertone Black
- Hammertone Gray
- Dark Gray
- Gray
- Metallic
- Beige
- Hunter Green
- Navy Blue
- Burgundy





T-CHORD
Shown with Alumni Smooth
Caster Chair

CHORD CONFIGURATIONS

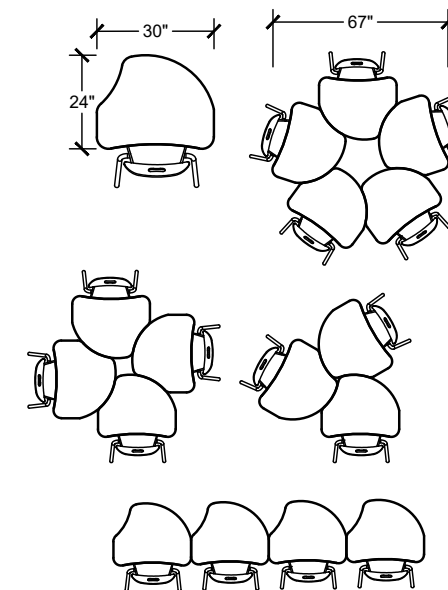

Chord

The Alumni Chord Desk was developed for traditional and progressive teaching styles to help implement 21st Century Learning concepts into the classroom. Optional casters make these desks easy to pull apart for individual study and testing purposes, or to move into multiple group configurations. In its ideal group configuration of 5, it can be rearranged to maximize the use of limited space commonly observed in today's classrooms. Full-frame construction takes the wiggle out of learning.

- 3/4" or 1 1/8" High Pressure Laminate (HPL) Top with Round Corner PVC Edge
- Fully welded table frame and leg assembly made of full perimeter 3/4" steel tubing welded to four 1 1/2" leg mounts designed to accept 1 1/8" O.D. round steel upper tube with inner round telescoping tube, adjustable height 22"-30"
- 100% Polyester Premium Powder Coat Finish
- Standard Glides: Marquis Nylon Swivel
- Optional Glides: Marquis Neoprene Swivel, Marquis Steel Swivel, Felt Snap-On, Q-Ball, Felt Snap-On or Quiet Glide
- Options: Bag Hook(s), Fixed Height, Solid or Perforated Steel Book Box, Wire Shelf, Two Legs with 2" Dual Wheel Locking Casters, ADA Height (26"-34"), Standing Height (34"-42")



T-CHORD



T-CHORD
Shown with optional
Casters

Model	Top Size	Wt. (lbs)	Freight Class
T-CHORD	24"x30"	29	KD 70
T-CHORD-BB	24"x30"	33	KD 70
T-CHORD-PERF	24"x30"	32	KD 70
T-CHORD-WS	24"x30"	32	KD 70

Chord Material Selector

Hard Plastic Top

- Dark Walnut
- Mahogany
- Wild Cherry
- Bannister Oak
- Loft Oak
- Golden Oak
- New Age Oak
- Sugar Maple
- Beige Sand
- Cosmic Strandz
- Gray Spectrum
- Gray Sand
- High Rise
- Vapour Strandz
- Sprout Green
- Agave Blue
- Eggplant Purple
- Pomegranate Red

Laminate Top

- Dark Walnut
- Mahogany
- Wild Cherry
- Bannister Oak
- Loft Oak
- New Age Oak
- Sugar Maple
- Cosmic Strandz
- Gray Spectrum
- High Rise
- Vapour Strandz
- Sprout Green
- Agave Blue
- Eggplant Purple
- Pomegranate Red
- Primary Yellow
- Primary Green
- Primary Blue
- Primary Red

PVC Edge

- Black
- Charcoal
- Warm Gray
- Gray
- Maple
- Beige
- Pumpkin
- Primary Yellow
- Primary Green
- Apple Green
- Navy Blue
- Primary Blue
- Sky Blue
- Plum
- Crimson
- Primary Red

Frame

- Black
- Hammertone Black
- Hammertone Gray
- Dark Gray
- Gray
- Metallic
- Beige
- Hunter Green
- Navy Blue
- Burgundy





Integrity Standing

The Alumni Integrity Standing Desk puts a modern twist on the classic student desk. The open-sided, cantilever-style frame construction allows for generous legroom and ease of access.

- Hard Plastic (HP) Top with Embossed Pencil Groove or 3/4" or 1 1/8" High Pressure Laminate (HPL) Top with Round Corner PVC Edge
- Two 2"x 1 1/4" upright oval steel tubes welded to two 2"x1 1/4" steel oval tube frame with a 2"x1 1/4" cross tube welded to midsection for strength and stability, adjustable height 34"-42"
- 100% Polyester Premium Powder Coat Finish
- Standard Glides: Floor-Friendly
- Optional Glides: Stainless Steel
- Options: Bag Hook, Solid or Perforated Steel Book Box, Wire Shelf, Chrome Upper Frame
- Footrest finished in Chrome



D-INT-CANT
Shown with Tall Balance Stool

Model	Top Size	Wt. (lbs)	Freight Class
D-INT-CANT-2026-FR	20"x26"	45	150

Sit Stand Material Selector

Hard Plastic Top

- Dark Walnut, Mahogany, Wild Cherry, Bannister Oak, Loft Oak, Golden Oak, New Age Oak, Sugar Maple, Beige Sand, Cosmic Strandz, Gray Spectrum, Gray Sand, High Rise, Vapor Strandz, Sprout Green, Agave Blue, Eggplant Purple, Pomegranate Red

Laminate Top

- Dark Walnut, Mahogany, Wild Cherry, Bannister Oak, Loft Oak, New Age Oak, Sugar Maple, Cosmic Strandz, Gray Spectrum, High Rise, Vapor Strandz, Sprout Green, Agave Blue, Eggplant Purple, Pomegranate Red, Primary Yellow, Primary Green, Primary Blue, Primary Red

PVC Edge

- Black, Charcoal, Warm Gray, Gray, Maple, Beige, Pumpkin, Primary Yellow, Primary Green, Apple Green, Navy Blue, Primary Blue, Sky Blue, Plum, Crimson, Primary Red

Frame

- Black, Hammertone Black, Hammertone Gray, Dark Gray, Gray, Metallic, Beige, Navy Blue, Burgundy, Hunter Green



TN-OGEE2232BR
Shown with Alumni Air 4-Leg Chair

Ogee Breeze Student

The Alumni Ogee Breeze Desk offers an interactive and creative table solution for any learning environment. Ogee is defined as having a double continuous S-shaped curve, allowing for endless configuration possibilities.

- 1 1/8" High Pressure Laminate (HPL) Top with Round Corner PVC Edge
- 2" Round Tube Leg with 1 7/8" Round Insert, adjustable height 22"-30"
- 100% Polyester Premium Powder Coat Finish
- Standard Glides: Adjustable
- Standard Glides: Stainless Steel
- Options: 3" Caster



Model	Top Size	Wt. (lbs)	Freight Class
TN-OGEE2232BR	22"x32"	32	KD 70

Ogee Breeze Material Selector

Laminate Top

- Dark Walnut, Mahogany, Wild Cherry, Bannister Oak, Loft Oak, New Age Oak, Sugar Maple, Cosmic Strandz, Gray Spectrum, High Rise, Vapor Strandz, Sprout Green, Agave Blue, Eggplant Purple, Pomegranate Red, Primary Yellow, Primary Green, Primary Blue, Primary Red

PVC Edge

- Black, Charcoal, Warm Gray, Gray, Maple, Beige, Pumpkin, Primary Yellow, Primary Green, Apple Green, Navy Blue, Primary Blue, Sky Blue, Plum, Crimson, Primary Red

Legs

- Metallic



Desks Cantilever / T-Leg



Integrity Cantilever



Integrity T-Leg



Honor Roll T-Leg
Closed Book Box



Honor Roll T-Leg
Study Top



Honor Roll Cantilever



Shown with optional Adjustable Height and Bag Hook

Integrity Cantilever



Integrity T-Leg



Honor Roll T-Leg Closed Book Box



Honor Roll T-Leg Study Top

The Alumni Integrity Cantilever Desk puts a modern twist on the classic student desk. Construction of the cantilever style frame allows for generous legroom and ease of access, for use in any learning environment.

- Hard Plastic (HP) Top or 3/4" or 1 1/8" High Pressure Laminate (HPL) Top with Round Corner PVC Edge
- Two 2" x 1 1/4" upright oval steel tubes welded to two 2" x 1 1/4" steel oval tube frame with a 2" x 1 1/4" cross tube welded to midsection for strength and stability, fixed height
- 100% Polyester Premium Powder Coat Finish
- Standard Glides: Floor-Friendly
- Optional Glides: Stainless Steel
- Options: Bag Hook, Solid or Perforated Steel Book Box, Wire Shelf, Chrome Upper Frame, Adjustable Height (22"-30"), ADA Height (26"-34"), Standing Height (34"-42")

The Alumni Integrity T-Leg Desk is an attractive and durable addition to any learning environment. Elliptical legs made with heavy gauge tubular steel offers a modern alternative to the traditional desk.

- Hard Plastic (HP) Top or 3/4" or 1 1/8" High Pressure Laminate (HPL) Top with Round Corner PVC Edge
- Two 2" x 1 1/4" upright oval steel tube frame with a 2" x 1 1/4" cross tube frame, fixed height
- 100% Polyester Premium Powder Coat Finish
- ABS Scuff Guard
- Optional Glides: Adjustable or Stainless Steel
- Options: Bag Hook, Solid or Perforated Steel Book Box, Wire Shelf, Chrome Upper Frame, Adjustable Height (22"-30"), ADA Height (26"-34"), Standing Height (34"-42")



Shown with optional Adjustable Height, Perforated Book Box and Bag Hook



Shown with optional Adjustable Height, Wire Shelf and Bag Hook



Shown with optional Wire Shelf and Bag Hook

Model	Top Size	Wt. (lbs)	Freight Class
D-INT-CANT-2026	20"x26"	40	150
D-INT-CANT-2036	20"x36"	43	150
D-INT-CANT-2228	22"x28"	44	150
D-INT-CANT-2424	24"x24"	44	150
D-INT-CANT-2430	24"x30"	45	150

Model	Top Size	Wt. (lbs)	Freight Class
D-INT-2026	20"x26"	27	150
D-INT-2036	20"x36"	30	150
D-INT-2430	24"x30"	30	150
D-INT-2228	22"x28"	29	150

The Alumni Honor Roll T-Leg Closed Book Box Desk is a durable, and budget-minded desk for all grade levels. T-Leg construction allows ease of access.

- Hard Plastic (HP) Top with Embossed Pencil Groove or Standard Plastic Laminate Top with Round Corner PVC Edge
- 1 1/2" square tube frame solid steel book box closed on three sides welded to legs, adjustable height 22"-30"
- 100% Polyester Premium Powder Coat Finish
- Vinyl Insert End Caps
- Optional Glides: Adjustable or Stainless Steel
- Options: Fixed Height, 3/4" or 1 1/8" High Pressure Laminate (HPL) Top with PVC Edge, ADA Height (26"-34"), Standing Height (34"-42")

Model	Top Size	Wt. (lbs)	Freight Class
DT-2026	20"x26"	42	150
DT-2430	24"x30"	58	150

The Alumni Honor Roll T-Leg Study Top Desk is a budget-minded study desk for all grade levels. T-Leg construction allows for generous legroom.

- Hard Plastic (HP) Top or Standard Plastic Laminate Top with Round Corner PVC Edge
- 1 1/2" square tube frame, adjustable height 22"-30"
- 100% Polyester Premium Powder Coat Finish
- Vinyl Insert End Caps
- Optional Glides: Adjustable or Stainless Steel
- Options: Bag Hook, Fixed Height, 3/4" or 1 1/8" High Pressure Laminate (HPL) Top with PVC Edge, ADA Height (26"-34"), Standing Height (34"-42")

Model	Top Size	Wt. (lbs)	Freight Class
STT-1824	18"x24"	37	150
STT-2026	20"x26"	40	150
STT-2036	20"x36"	45	150
STT-2228	22"x28"	45	150
STT-2424	24"x24"	42	150
STT-2430	24"x30"	45	150

Cantilever / T-Leg Material Selector

Hard Plastic Top

- Dark Walnut
- Mahogany
- Wild Cherry
- Bannister Oak
- Loft Oak
- Golden Oak
- New Age Oak
- Sugar Maple
- Beige Sand
- Cosmic Strandz
- Gray Spectrum
- Gray Sand

Laminate Top

- Dark Walnut
- Mahogany
- Wild Cherry
- Bannister Oak
- Loft Oak
- New Age Oak
- Sugar Maple
- Cosmic Strandz
- Gray Spectrum
- High Rise
- Vapor Strandz
- Sprout Green

PVC Edge

- Black
- Charcoal
- Warm Gray
- Gray
- Maple
- Beige
- Pumpkin
- Primary Yellow
- Primary Green
- Apple Green
- Navy Blue
- Primary Blue
- Sky Blue
- Plum
- Crimson
- Primary Red

- High Rise
- Vapor Strandz
- Sprout Green
- Agave Blue
- Eggplant Purple
- Pomegranate Red

Frame

- Black
- Hammertone Black
- Hammertone Gray
- Dark Gray
- Gray
- Metallic
- Beige
- Navy Blue
- Burgundy
- Hunter Green





Honor Roll Cantilever

The Alumni Honor Roll Cantilever Desk puts a modern twist on the classic student desk. Construction of the cantilever style frame allows for generous legroom and ease of access, for use in any learning environment.

- Hard Plastic (HP) Top or Standard Plastic Laminate Top with Round Corner PVC Edge
- Two 1" O.D. upright legs on a 1" O.D. cross tube welded to mid-section of leg assembly to provide strength and stability, fixed height
- Chrome Finish
- Standard Glides: Floor-Friendly
- Optional Glides: Stainless Steel
- Options: Bag Hook, Wire Shelf

Model	Top Size	Wt. (lbs)	Freight Class
DRD-CANT-1824	18"x24"	32	150
DRD-CANT-2026	20"x26"	35	150
DRD-CANT-2228	22"x28"	41	150
DRD-CANT-2424	24"x24"	38	150
DRD-CANT-2430	24"x30"	40	150

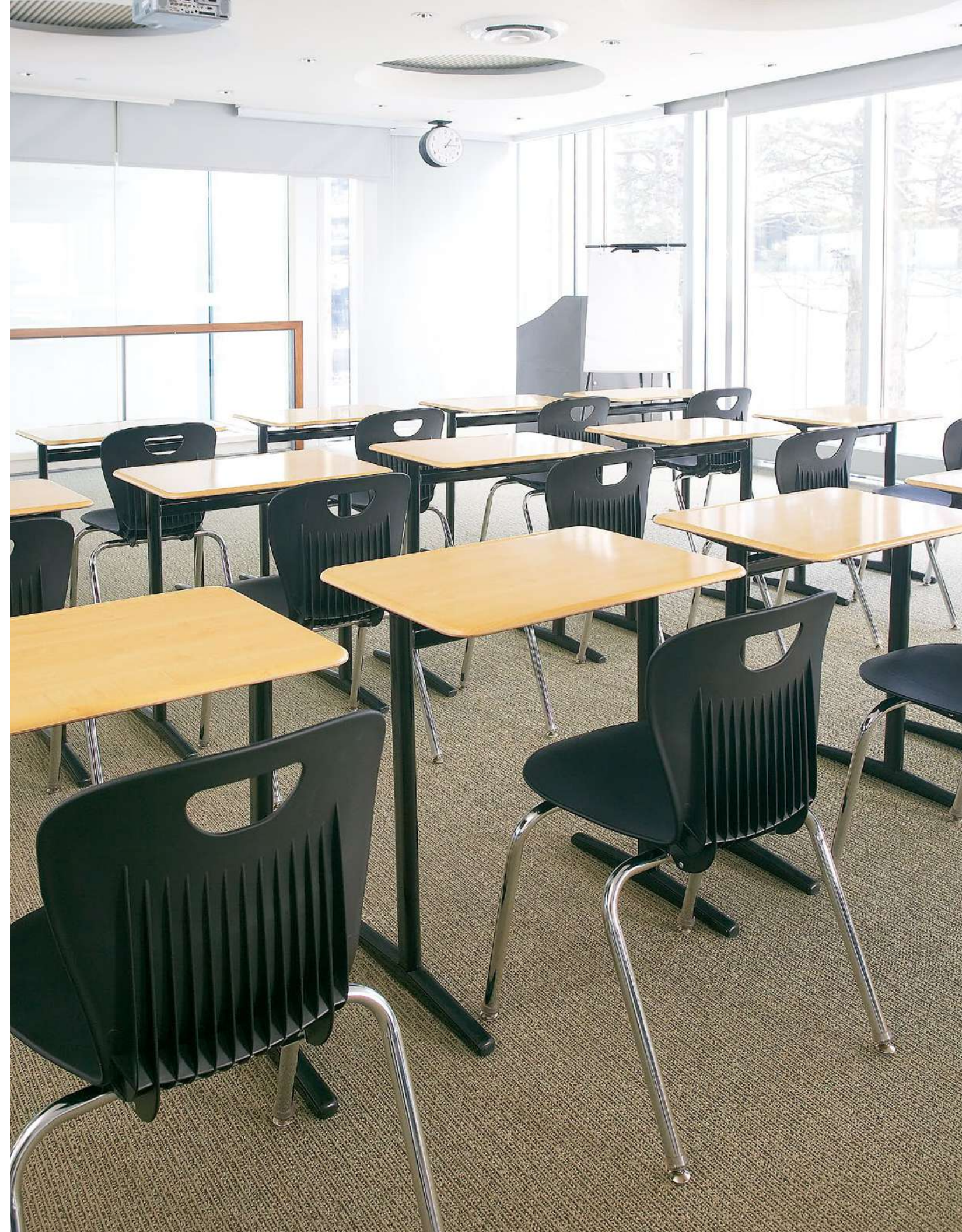

Honor Roll Cantilever Material Selector

Hard Plastic Top

- | | | | | | |
|---------------|-----------------|---------------|------------------|-----------------|-------------------|
| ● Dark Walnut | ● Bannister Oak | ● New Age Oak | ● Cosmic Strandz | ● High Rise | ● Agave Blue |
| ● Mahogany | ● Loft Oak | ● Sugar Maple | ● Gray Spectrum | ● Vapor Strandz | ● Eggplant Purple |
| ● Wild Cherry | ● Golden Oak | ● Beige Sand | ● Gray Sand | ● Sprout Green | ● Pomegranate Red |

Laminate Top

- | | | | | | | |
|---------------|-----------------|------------------|-----------------|-------------------|------------------|---------------|
| ● Dark Walnut | ● Bannister Oak | ● Sugar Maple | ● High Rise | ● Agave Blue | ● Primary Yellow | ● Primary Red |
| ● Mahogany | ● Loft Oak | ● Cosmic Strandz | ● Vapor Strandz | ● Eggplant Purple | ● Primary Green | |
| ● Wild Cherry | ● New Age Oak | ● Gray Spectrum | ● Sprout Green | ● Pomegranate Red | ● Primary Blue | |

PVC Edge

- | | | | |
|-------------|------------------|-----------------|---------------|
| ● Black | ● Maple | ● Primary Green | ● Sky Blue |
| ● Charcoal | ● Beige | ● Apple Green | ● Plum |
| ● Warm Gray | ● Pumpkin | ● Navy Blue | ● Crimson |
| ● Gray | ● Primary Yellow | ● Primary Blue | ● Primary Red |

Frame

- Chrome



Desks Lift Lid



Integrity T-Leg



Honor Roll T-Leg



Honor Roll 4-Leg



Integrity T-Leg

The Alumni Integrity T-Leg Lift Lid Desk features an exclusive anti-pinch front design, protecting fingers from being pinched when the lid is closed. Its 5 1/2" deep book box allows for better book storage. Designed to open wide, making it easier to find items at the back of the desk. The lift lid desk includes a unique angled pencil tray for quick access to pens and pencils without opening the lid.

- Hard Plastic (HP) Top with Embossed Pencil Groove or 3/4" High Pressure Laminate (HPL) Top with Round Corner PVC Edge
- Two 2"x1 1/4" upright oval steel tubes with fully adjustable painted T-Leg insert tubes welded to a contemporary style base, adjustable height 22"-30"
- 100% Polyester Premium Powder Coat Finish
- ABS Scuff Guard
- Optional Glides: Adjustable or Stainless Steel
- Options: Fixed Height, ADA Height (26"-34")

Model	Top Size	Wt. (lbs)	Freight Class
DTL-INT-1824	18"x24"	39	150
DTL-INT-2026	20"x26"	41	150



Honor Roll T-Leg

The Alumni Honor Roll T-Leg Lift Lid Desk features an exclusive anti-pinch front design, protecting fingers from being pinched when the lid is closed. Its 5 1/2" deep book box allows for better book storage. Designed to open wide, making it easier to find items at the back of the desk. The lift lid desk includes a unique angled pencil tray for quick access to pens and pencils without opening the lid.

- Hard Plastic (HP) Top with Embossed Pencil Groove or 3/4" High Pressure Laminate (HPL) Top with PVC Edge
- 1 1/2" square tube legs with adjustable chrome T-Leg insert welded to book box with side panels, adjustable height 22"-30"
- 100% Polyester Premium Powder Coat Finish
- Vinyl Insert End Caps
- Optional Glides: Adjustable or Stainless Steel
- Options: Fixed Height, ADA Height (26"-34")



Pinch Proof Design

Model	Top Size	Wt. (lbs)	Freight Class
DTL-1824	18"x24"	33.5	150
DTL-2026	20"x26"	35.5	150



Honor Roll 4-Leg

The Alumni Honor Roll 4-Leg Lift Lid Desk features an exclusive anti-pinch front design that protects fingers from being pinched when the lid is closed. Its 5 1/2" deep book box allows for better book storage. Designed to open wide, it makes it easier to find items at the back of the desk. The lift lid desk includes a unique angled pencil tray for quick access to pens and pencils without opening the lid.

- Hard Plastic (HP) Top with Embossed Pencil Groove or 3/4" High Pressure Laminate (HPL) Top with PVC Edge
- 1 1/8" O.D. round legs with chrome insert, adjustable height 22"-30"
- 100% Polyester Premium Powder Coat Finish
- Standard Glides: Marquis Nylon Swivel
- Optional Glides: Marquis Neoprene Swivel, or Marquis Steel Swivel
- Options: Two Legs with 2" Dual Wheel Locking Casters, Fixed Height, ADA Height (26"-34")



Shown with optional Casters

Model	Top Size	Wt. (lbs)	Freight Class
DFL-RD-1824	18"x24"	32	150
DFL-RD-2026	20"x26"	35	150

Lift Lid Material Selector

Hard Plastic Top

- Dark Walnut
- Mahogany
- Wild Cherry
- Bannister Oak
- Loft Oak
- Golden Oak
- New Age Oak
- Sugar Maple
- Beige Sand
- Cosmic Strandz
- Gray Spectrum
- Gray Sand
- High Rise
- Vapor Strandz
- Sprout Green
- Agave Blue
- Eggplant Purple
- Pomegranate Red

Laminate Top

- Dark Walnut
- Mahogany
- Wild Cherry
- Bannister Oak
- Loft Oak
- New Age Oak
- Sugar Maple
- Cosmic Strandz
- Gray Spectrum
- High Rise
- Vapor Strandz
- Sprout Green
- Agave Blue
- Eggplant Purple
- Pomegranate Red
- Primary Yellow
- Primary Green
- Primary Blue
- Primary Red

PVC Edge

- Black
- Charcoal
- Warm Gray
- Gray
- Maple
- Beige
- Pumpkin
- Primary Yellow
- Primary Green
- Apple Green
- Navy Blue
- Primary Blue
- Sky Blue
- Plum
- Crimson
- Primary Red

Frame

- Black
- Hammertone Black
- Hammertone Gray
- Dark Gray
- Gray
- Metallic
- Beige
- Hunter Green
- Navy Blue
- Burgundy

Desks 4-Leg



Honor Roll Square Leg



Honor Roll Round Leg



Junior Executive



Honor Roll Study Top



Honor Roll Square Leg Open Shelf



Honor Roll Square Leg Wire Shelf



T-Rect



Honor Roll Plastic Book Box



Study Carrel



Honor Roll Square Leg



Honor Roll Round Leg

The Alumni Honor Roll Square Leg Desk with Closed Book Box is attractive, sturdy and durable. A budget-minded desk for all grade levels. Legs are welded to the book box providing strength and stability.

- Hard Plastic (HP) Top with Embossed Pencil Groove or Standard Plastic Laminate Top with Round Corner PVC Edge
- 1 1/8" Square Legs with Chrome Insert, adjustable height 22"-30"
- 100% Polyester Premium Powder Coat Finish
- Standard Glides: Vinyl Insert
- Optional Glides: Adjustable, Stainless Steel
- Options: 3/4" or 1 1/8" High Pressure Laminate (HPL) Top with PVC Edge, Fixed Height, ADA Height (26"-34"), or Standing Height (34"-42")

Model	Top Size	Wt. (lbs)	Freight Class
DSQ-1824	18"x24"	36	150
DSQ-2026	20"x26"	40	150
DSQ-2228	22"x28"	43	150
DSQ-2424	24"x24"	43	150
DSQ-2430	24"x30"	48	150

The Alumni Honor Roll Round Leg Desk with Closed Book Box is attractive, sturdy and durable. A budget-minded desk for all grade levels. Legs are welded to the book box providing strength and stability.

- Hard Plastic (HP) Top with Embossed Pencil Groove or Standard Plastic Laminate Top with Round Corner PVC Edge
- 1 1/8" O.D. Round Legs with Chrome Insert, adjustable height 22"-30"
- 100% Polyester Premium Powder Coat Frame
- Standard Glides: Vinyl Insert
- Optional Glides: Marquis Nylon Swivel, Marquis Neoprene Swivel, Marquis Steel Swivel, Felt Snap-On, Q-Ball or Quiet Glide
- Options: U-Brace, 3/4" or 1 1/8" High Pressure Laminate (HPL) Top with PVC Edge, Fixed Height, ADA Height (26"-34"), Standing Height (34"-42")

Model	Top Size	Wt. (lbs)	Freight Class
DRD-1824	18"x24"	36	150
DRD-2026	20"x26"	40	150
DRD-2036	20"x36"	48	150
DRD-2228	22"x28"	43	150
DRD-2424	24"x24"	43	150
DRD-2430	24"x30"	48	150



Junior Executive

The Alumni Junior Executive Desk provides a spacious individual work surface and storage for students. Featuring a large storage area for study materials. Height adjustable to accommodate students from Elementary to High School.

- Hard Plastic (HP) Top with Embossed Pencil Groove or Standard Plastic Laminate Top with Round Corner PVC Edge
- 1 1/8" Square Legs with Chrome Insert, adjustable height 22"-30"
- 100% Polyester Premium Powder Coat Finish
- Standard Glides: Adjustable
- Optional Glides: Stainless Steel
- Options: 3/4" or 1 1/8" High Pressure Laminate (HPL) Top with PVC Edge, ADA Height (26"-34")

Model	Top Size	Wt. (lbs)	Freight Class
DJE-2036	20"x36"	54	250

4-Leg Material Selector

Hard Plastic Top

- Dark Walnut
- Mahogany
- Wild Cherry
- Bannister Oak
- Loft Oak
- Golden Oak
- New Age Oak
- Sugar Maple
- Beige Sand
- Cosmic Strandz
- Gray Spectrum
- Gray Sand

Laminate Top

- Dark Walnut
- Mahogany
- Wild Cherry
- Bannister Oak
- Loft Oak
- New Age Oak
- Sugar Maple
- Cosmic Strandz
- Gray Spectrum
- High Rise
- Vapor Strandz
- Sprout Green

PVC Edge

- Black
- Charcoal
- Warm Gray
- Gray
- Maple
- Beige
- Pumpkin
- Primary Yellow
- Primary Green
- Apple Green
- Navy Blue
- Primary Blue
- Sky Blue
- Plum
- Crimson
- Primary Red



Shown with optional Marquis Swivel Glide

Honor Roll Study Top

The Alumni Honor Roll Round Leg Study Top Desk is attractive, sturdy and durable. U-shaped support brace is incorporated for a wobble-free classroom solution.

- Hard Plastic (HP) Top with Embossed Pencil Groove or Standard Plastic Laminate Top with Round Corner PVC Edge
- 1 1/8" O.D. Round Legs with Chrome Insert, adjustable height 22"-30"
- 100% Polyester Premium Powder Coat Finish
- Standard Glides: Vinyl Insert
- Optional Glides: Marquis Nylon Swivel, Marquis Neoprene Swivel, Marquis Steel Swivel, Felt Snap-On, Q-Ball or Quiet Glide
- Options: Bag Hook, Fixed Height, ADA Height (26"-34"), Standing Height (34"-42"), Wire Shelf, Chrome Frame, 3/4" or 1 1/8" High Pressure Laminate (HPL) Top with PVC Edge

Model	Top Size	Wt. (lbs)	Freight Class
SDRD-1824	18"x24"	30	150
SDRD-2026	20"x26"	33	150
SDRD-2036	20"x36"	39	150
SDRD-2424	24"x24"	35	150
SDRD-2430	24"x30"	39	150

High Rise

- High Rise
- Vapor Strandz
- Sprout Green
- Agave Blue
- Eggplant Purple
- Pomegranate Red

Frame

- Agave Blue
- Eggplant Purple
- Pomegranate Red
- Primary Yellow
- Primary Green
- Primary Blue
- Primary Red
- Navy Blue
- Burgundy
- Black
- Hammertone Black
- Hammertone Gray
- Dark Gray
- Gray
- Metallic
- Beige
- Hunter Green





**Honor Roll
Square Leg Open Shelf**

The Alumni Honor Roll Square Leg Open Shelf Desk is suited for Middle and High School Students.

- Hard Plastic (HP) Top with Embossed Pencil Groove or Standard Plastic Laminate with Round Corner PVC Edge
- 1 1/8" Square Leg Frame, adjustable height 22"-30"
- 100% Premium Powder Coat Finish
- Standard Glides: Vinyl Insert
- Optional Glides: Adjustable or Stainless Steel
- Options: Fixed Height, 3/4" or 1 1/8" High Pressure Top (HPL) with PVC Edge

Model	Top Size	Wt. (lbs)	Freight Class
DSQ-OS-1824	18"x24"	28	150
DSQ-OS-2026	20"x26"	30	150
DSQ-OS-2228	22"x28"	33	150
DSQ-OS-2424	24"x24"	33	150
DSQ-OS-2430	24"x30"	38	150



**Honor Roll
Square Leg Wire Shelf**

The Alumni Honor Roll Square Leg Wire Shelf Desk is suited for Middle and High School Students.

- Hard Plastic (HP) Top with Embossed Pencil Groove or Standard Plastic Laminate with Round Corner PVC Edge
- 1 1/8" Square Leg Frame, adjustable height 22"-30"
- 100% Premium Powder Coat Finish
- Standard Glides: Vinyl Insert
- Optional Glides: Adjustable or Stainless Steel
- Options: Bag Hook, Fixed Height, Chrome Frame, 3/4" or 1 1/8" High Pressure Top (HPL) with PVC Edge

Model	Top Size	Wt. (lbs)	Freight Class
DWS-1824	18"x24"	29	150
DWS-2026	20"x26"	31	150
DWS-2228	22"x28"	34	150
DWS-2430	24"x30"	39	150



T-Rect

The Alumni T-Rect Student Desk is attractive, sturdy and durable. Stylish and functional with a fully-welded self-supporting frame. A budget-minded desk for all grade levels.

- Hard Plastic (HP) Top with Embossed Pencil Groove or 3/4" or 1 1/8" High Pressure Laminate (HPL) Top with Round Corner PVC Edge
- 1 1/8" O.D. Round Legs with Chrome Insert, adjustable height 22"-30"
- 100% Polyester Premium Powder Coat Finish
- Standard Glides: Marquis Nylon Swivel
- Optional Glides: Marquis Neoprene Swivel, Marquis Steel Swivel, Felt Snap-On, Q-Ball or Quiet Glide
- Options: Bag Hook, Solid or Perforated Steel Book Box, or Plastic Book Box

Model	Top Size	Wt. (lbs)	Freight Class
T-RECT-1824	18"x24"	33	KD 70



Shown with optional Marquis Swivel Glide

**Honor Roll Plastic Book
Box**

The Alumni Honor Roll Plastic Book Box Desk features a fully welded, self-supporting frame. Easy to clean polypropylene book box with smooth texture finish is available in multiple colors to coordinate with chairs or to simply add a bit of flair to the classroom. 5" deep book box opening provides ample access to storage space.

- Hard Plastic (HP) Top with Embossed Pencil Groove or Standard Plastic Laminate Top with Round Corner PVC Edge
- Round Legs 1 1/8" with Chrome Insert, adjustable height 22"-30"
- 100% Polyester Premium Powder Coat Finish
- Standard Glides: Vinyl Insert
- Optional Glides: Marquis Nylon Swivel, Marquis Neoprene Swivel, Marquis Steel Swivel, Felt Snap-On, Q-Ball or Quiet Glide
- Options: 3/4" or 1 1/8" High Pressure Laminate (HPL) Top with PVC Edge, Chrome Frame, Fixed Height, ADA Height (26"-34")

Model	Top Size	Wt. (lbs)	Freight Class
DSQ-1824-PB	18"x24"	34	150
DSQ-2026-PB	20"x26"	36	150
DSQ-2228-PB	22"x28"	40	150
DSQ-2424-PB	24"x24"	38	150
DSQ-2430-PB	24"x30"	47	150

4-Leg Material Selector

Hard Plastic Top

- Dark Walnut
- Mahogany
- Wild Cherry
- Bannister Oak
- Loft Oak
- Golden Oak
- New Age Oak
- Sugar Maple
- Beige Sand
- Cosmic Strandz
- Gray Spectrum
- Gray Sand
- High Rise
- Vapor Strandz
- Sprout Green
- Agave Blue
- Eggplant Purple
- Pomegranate Red

Laminate Top

- Dark Walnut
- Mahogany
- Wild Cherry
- Bannister Oak
- Loft Oak
- New Age Oak
- Sugar Maple
- Cosmic Strandz
- Gray Spectrum
- High Rise
- Vapor Strandz
- Sprout Green
- Agave Blue
- Eggplant Purple
- Pomegranate Red
- Primary Yellow
- Primary Green
- Primary Blue
- Primary Red

PVC Edge

- Black
- Charcoal
- Warm Gray
- Gray
- Maple
- Beige
- Pumpkin
- Primary Yellow
- Primary Green
- Apple Green
- Navy Blue
- Primary Blue
- Sky Blue
- Plum
- Crimson
- Primary Red

Frame

- Black
- Hammertone Black
- Hammertone Gray
- Dark Gray
- Gray
- Metallic
- Chrome
- Beige
- Hunter Green
- Navy Blue
- Burgundy

Honor Roll Plastic Book Box Material Selector

Polypropylene

- Black
- Graphite
- Gray
- Chocolate
- Pumpkin
- Yellow
- Sunburst
- Hunter Green
- Apple Green
- Navy Blue
- Royal Blue
- Sky Blue
- Plum
- Burgundy
- Crimson
- Red





Study Carrel

The Alumni Study Carrel provides a great space for testing and private study. Includes upper shelf for extra storage.

- 3/4" or 1 1/8" High Pressure Laminate (HPL) Top with Round Corner PVC Edge
- 1 1/8" Square Upper Tube with 1" Square Tube Insert, adjustable height 22"-30"
- 100% Polyester Premium Powder Coat Finish
- Standard Glides: Adjustable
- Optional Glides: Stainless Steel
- Options: Fixed Height, ADA Height (26"-34"), Grommet



SC-OVAL-2436

Model	Top Size	Wt. (lbs)	Freight Class
SC-2436	24"x36"	104	KD 150
SC-OVAL-2436	24"x36"	107	KD 150

Study Carrel Material Selector

Laminate Top

- | | | | | | | |
|---------------|-----------------|------------------|-----------------|-------------------|------------------|---------------|
| ● Dark Walnut | ● Bannister Oak | ● Sugar Maple | ● High Rise | ● Agave Blue | ● Primary Yellow | ● Primary Red |
| ● Mahogany | ● Loft Oak | ● Cosmic Strandz | ● Vapor Strandz | ● Eggplant Purple | ● Primary Green | |
| ● Wild Cherry | ● New Age Oak | ● Gray Spectrum | ● Sprout Green | ● Pomegranate Red | ● Primary Blue | |

PVC Edge

- | | | | |
|-------------|------------------|-----------------|---------------|
| ● Black | ● Maple | ● Primary Green | ● Sky Blue |
| ● Charcoal | ● Beige | ● Apple Green | ● Plum |
| ● Warm Gray | ● Pumpkin | ● Navy Blue | ● Crimson |
| ● Gray | ● Primary Yellow | ● Primary Blue | ● Primary Red |

Frame

- | | | |
|--------------------|----------------|-------------|
| ● Black | ● Gray | ● Navy Blue |
| ● Hammertone Black | ● Metallic | ● Burgundy |
| ● Hammertone Gray | ● Beige | |
| ● Dark Gray | ● Hunter Green | |



Desks Double



Integrity Double Leg



Integrity Single Leg



Honor Roll 4-Leg



Honor Roll T-Leg



Shown with optional Chrome Upper Frame

Integrity Double Leg

The Alumni Integrity Double Leg Desk is a contemporary desk solution. Elliptical legs made with heavy gauge tubular steel offer a modern and durable alternative to the traditional double desk.

- 3/4" or 1 1/8" High Pressure Laminate (HPL) Top with Round Corner PVC Edge
- All welded frame and legs consist of two 2"x1 1/4" 13-gauge upright oval steel tubes, adjustable height 22"-30"
- Book Boxes: Two Solid Steel Book Boxes
- 100% Polyester Premium Powder Coat Finish
- Standard Glides: Floor-Friendly
- Optional Glides: Stainless Steel
- Options: Bag Hook, Two Plastic Book Boxes (60" only), Perforated Steel Book Boxes, Fixed Height, ADA Height (26"-34"), Chrome Upper Frame, "C" or "T" Style Leg

Model	Top Size	Wt. (lbs)	Freight Class
T-INT-DL-2048-2BB	20"x48"	61	250
T-INT-DL-2060-2BB	20"x60"	68	250
T-INT-DL-2448-2BB	24"x48"	75	250
T-INT-DL-2460-2BB	24"x60"	82	250



Shown with optional Plastic Book Box

Integrity Single Leg

The Alumni Integrity Single Leg Double Desk is a contemporary desk solution. Elliptical legs made with heavy gauge tubular steel offer a modern and durable alternative to the traditional double desk. Book boxes offered in steel or polypropylene to coordinate with chairs or add colorful flair to the classroom.

- 3/4" or 1 1/8" High Pressure Laminate (HPL) Top with Round Corner PVC Edge
- All welded frame and legs consist of two 2"x1 1/4" upright oval steel tubes, adjustable height 22"-30"
- 100% Polyester Premium Powder Coat Finish
- ABS Scuff Guard
- Optional Glides: Adjustable or Stainless Steel
- Options: Bag Hook, Fixed Height, ADA Height (26"-34"), Two Solid or Perforated Steel Book Boxes, Two Plastic Book Boxes (60" only)

Model	Top Size	Wt. (lbs)	Freight Class
D-INT-2048	20"x48"	56	150
D-INT-2060	20"x60"	63	150
D-INT-2448	24"x48"	70	150
D-INT-2460	24"x60"	77	150



Honor Roll 4-Leg

The Alumni Honor Roll 4-Leg Double Desk with Closed Shelf is attractive and durable. A budget-minded desk for all grade levels. Closed shelf on all three sides. Ample storage space for notebooks, textbooks, tablets and school supplies.

- Standard Plastic Laminate Top with Round Corner PVC Edge
- Fully Welded Book Box to Legs, 1 1/8" Square Tube with 1" Square Tube Insert, adjustable height 22"-30"
- 100% Polyester Premium Powder Coat Finish
- Standard Glides: Adjustable
- Optional Glides: Stainless Steel
- Options: Fixed Height, ADA Height (26"-34"), 3/4" or 1 1/8" High Pressure Laminate (HPL) Top with PVC Edge

Model	Top Size	Wt. (lbs)	Freight Class
DSQ-DBL-2048	20"x48"	54	150
DSQ-DBL-2448	24"x48"	68	150
DSQ-DBL-2060	20"x60"	60	150
DSQ-DBL-2460	24"x60"	73	150

Double Desk Material Selector

Laminate Top

- Dark Walnut
- Mahogany
- Wild Cherry
- Bannister Oak
- Loft Oak
- New Age Oak
- Sugar Maple
- Cosmic Strandz
- Gray Spectrum
- High Rise
- Vapor Strandz
- Sprout Green

PVC Edge

- Black
- Charcoal
- Warm Gray
- Gray
- Maple
- Beige
- Pumpkin
- Primary Yellow
- Primary Green
- Apple Green
- Navy Blue
- Primary Blue
- Sky Blue
- Plum
- Crimson
- Primary Red

Frame

- Black
- Hammertone Black
- Hammertone Gray
- Dark Gray
- Gray
- Metallic
- Beige
- Hunter Green
- Agave Blue
- Eggplant Purple
- Pomegranate Red
- Primary Yellow
- Primary Green
- Primary Blue
- Primary Red
- Navy Blue
- Burgundy



Honor Roll T-Leg

The Alumni Honor Roll T-Leg Double Desk with Closed Shelf is attractive and durable. T-leg construction allows for ease of access. Legs are welded to the underside of the steel shelf for strength.

- Standard Plastic Laminate Top with Round Corner PVC Edge
- 1 1/2" Square Tube Legs with Adjustable Insert Chrome T-Legs, adjustable height 22"-30"
- 100% Polyester Premium Powder Coat Finish
- Vinyl Insert End Caps
- Standard Glides: Adjustable
- Optional Glides: Stainless Steel
- Options: Fixed Height, ADA Height (26"-34"), 3/4" or 1 1/8" High Pressure Laminate (HPL) Top with PVC Edge
- Available Without Book Box (STT)

Model	Top Size	Wt. (lbs)	Freight Class
DT-DBL-2048	20"x48"	57	150
DT-DBL-2060	20"x60"	59	150
DT-DBL-2448	24"x48"	61	150
DT-DBL-2460	24"x60"	63	150
STT-2048	20"x48"	54	150
STT-2060	20"x60"	56	150
STT-2448	24"x48"	58	150
STT-2460	24"x60"	60	150



Desks Combo



Explorer 4-Leg



Explorer Sled



Air 4-Leg



Air Sled



Smooth 4-Leg



Smooth Sled



Integrity 4-Leg



Integrity Sled



Honor Roll 4-Leg



Honor Roll Sled



Marquis 4-Leg



Marquis Sled



Shown with optional Chrome Frame



Shown with optional Book Rack

Explorer

An all-in-one solution, combo desks with the Alumni Explorer Seat Shell features a center "Power Rib" providing lumbar support.

The Alumni Explorer 4-Leg Combination Desk is available with opposite entry to enable full use of classroom space.

The Alumni Explorer Sled Combination Desk design allows for ease of entry for students from either side of the desk.

- Standard Plastic Laminate Top with Round Corner PVC Edge or Hard Plastic (HP) Top with Embossed Pencil Groove
- Fully Welded Tubular Steel Frame
- Standard 4-Leg Finish: 100% Polyester Premium Powder Coat
- Sled Finish: Chrome
- Standard 4-Leg Glides: Marquis Nylon Swivel
- Standard Sled Glides: Grip
- Optional 4-Leg Glides: Marquis Neoprene Swivel, Marquis Steel Swivel, Felt Snap-On, Q-Ball or Quiet Glide
- Options: Book Rack, Bag Hook, CAL 133 Compliant, Opposite Entry (4-Leg), Chrome Frame (4-Leg)

Model	Top Size	Height	Wt. (lbs)	Freight Class
CD-4LEG-EXPL-1824	18"x24"	18" S. H.	37	300
CD-SLED-EXPL-1824	18"x24"	18" S. H.	40	300



Shown with optional Book Rack & Chrome Frame



Air

An all-in-one solution, combo desks with the Alumni Air Seat Shell feature unique ventilation holes to provide breathability holes for students.

The Alumni Air 4-Leg Combination Desk is available with opposite entry to enable full use of classroom space.

The Alumni Air Sled Combination Desk design allows for ease of entry for students from either side of the desk.

- Standard Plastic Laminate Top with Round Corner PVC Edge or Hard Plastic (HP) Top with Embossed Pencil Groove
- Fully Welded Tubular Steel Frame
- Standard 4-Leg Finish: 100% Polyester Premium Powder Coat
- Sled Finish: Chrome
- Standard 4-Leg Glides: Marquis Nylon Swivel
- Standard Sled Glides: Grip
- Optional 4-Leg Glides: Marquis Neoprene Swivel, Marquis Steel Swivel, Felt Snap-On, Q-Ball or Quiet Glide
- Options: Book Rack, Bag Hook, CAL 133 Compliant, Opposite Entry (4-Leg), Chrome Frame (4-Leg)

Model	Top Size	Height	Wt. (lbs)	Freight Class
CD-4LEG-AIR-1824	18"x24"	18" S. H.	41	300
CD-SLED-AIR-1824	18"x24"	18" S. H.	42	300



Shown with optional Chrome Frame



Smooth

An all-in-one solution, combo desks with the Alumni Smooth Seat Shell feature a rib-less back and blow-molded cavity providing shoulder support.

The Alumni Smooth 4-Leg Combination Desk is available with opposite entry to enable full use of classroom space.

The Alumni Smooth Sled Combination Desk design allows for ease of entry for students from either side of the desk.

- Standard Plastic Laminate Top with Round Corner PVC Edge or Hard Plastic (HP) Top with Embossed Pencil Groove
- Fully Welded Tubular Steel Frame
- Standard 4-Leg Finish: 100% Polyester Premium Powder Coat
- Sled Finish: Chrome
- Standard 4-Leg Glides: Marquis Nylon Swivel
- Standard Sled Glides: Grip
- Optional 4-Leg Glides: Marquis Neoprene Swivel, Marquis Steel Swivel, Felt Snap-On, Q-Ball or Quiet Glide
- Options: Book Rack, Bag Hook, CAL 133 Compliant, Opposite Entry (4-Leg), Chrome Frame (4-Leg)

Model	Top Size	Height	Wt. (lbs)	Freight Class
CD-4LEG-SM-1824	18"x24"	18" S. H.	41	300
CD-SLED-SM-1824	18"x24"	18" S. H.	42	300



Shown with optional Book Rack & Chrome Frame



Shown with optional Book Rack

Integrity

An all-in-one solution, combo desks with the Alumni Integrity Seat Shell feature a reinforced ribbed back providing proper lumbar support.

The Alumni Integrity 4-Leg Combination Desk is available with opposite entry to enable full use of classroom space.

The Alumni Integrity Sled Combination Desk design allows for ease of entry for students from either side of the desk.

- Standard Plastic Laminate Top with Round Corner PVC Edge or Hard Plastic (HP) Top with Embossed Pencil Groove
- Fully Welded Tubular Steel Frame
- Standard 4-Leg Finish: 100% Polyester Premium Powder Coat
- Sled Finish: Chrome
- Standard 4-Leg Glides: Marquis Nylon Swivel
- Standard Sled Glides: Grip
- Optional 4-Leg Glides: Marquis Neoprene Swivel, Marquis Steel Swivel, Felt Snap-On, Q-Ball or Quiet Glide
- Options: Book Rack, Bag Hook, CAL 133 Compliant, Opposite Entry (4-Leg), Chrome Frame (4-Leg)

Model	Top Size	Height	Wt. (lbs)	Freight Class
CD-4LEG-INT-1824	18"x24"	18" S. H.	43	300
CD-SLED-INT-1824	18"x24"	18" S. H.	44	300



Shown with optional Chrome Frame



Shown with optional Book Rack

Honor Roll

An all-in-one solution, combo desks with the Alumni Honor Roll Seat Shell feature an extra thick polypropylene for added durability.

The Alumni Honor Roll 4-Leg Combination Desk is available with opposite entry to enable full use of classroom space.

The Alumni Honor Roll Sled Combination Desk design allows for ease of entry for students from either side of the desk.

- Standard Plastic Laminate Top with Round Corner PVC Edge or Hard Plastic (HP) Top with Embossed Pencil Groove
- Fully Welded Tubular Steel Frame
- Standard 4-Leg Finish: 100% Polyester Premium Powder Coat
- Sled Finish: Chrome
- Standard 4-Leg Glides: Marquis Nylon Swivel
- Standard Sled Glides: Grip
- Optional 4-Leg Glides: Marquis Neoprene Swivel, Marquis Steel Swivel, Felt Snap-On, Q-Ball or Quiet Glide
- Options: Book Rack, Bag Hook, CAL 133 Compliant, Opposite Entry (4-Leg), Chrome Frame (4-Leg)

Model	Top Size	Height	Wt. (lbs)	Freight Class
CD-4LEG-HR-1824	18"x24"	18" S. H.	43	300
CD-SLED-HR-1824	18"x24"	18" S. H.	44	300

Combo Material Selector

Shell

- Black
- Graphite
- Gray
- Chocolate
- Pumpkin
- Yellow
- Sunburst
- Hunter Green
- Apple Green
- Navy Blue
- Royal Blue
- Sky Blue
- Plum
- Burgundy
- Crimson
- Red

Hard Plastic Top

- Dark Walnut
- Mahogany
- Wild Cherry
- Bannister Oak
- Loft Oak
- Golden Oak
- New Age Oak
- Sugar Maple
- Beige Sand
- Cosmic Strandz
- Gray Spectrum
- Gray Sand
- High Rise
- Vapor Strandz
- Sprout Green
- Agave Blue
- Eggplant Purple
- Pomegranate Red

Laminate Top

- Dark Walnut
- Mahogany
- Wild Cherry
- Bannister Oak
- Loft Oak
- New Age Oak
- Sugar Maple
- Cosmic Strandz
- Gray Spectrum
- High Rise
- Vapor Strandz
- Sprout Green
- Agave Blue
- Eggplant Purple
- Pomegranate Red
- Primary Yellow
- Primary Green
- Primary Blue
- Primary Red

PVC Edge

- Black
- Charcoal
- Warm Gray
- Gray
- Maple
- Beige
- Pumpkin
- Primary Yellow
- Primary Green
- Apple Green
- Navy Blue
- Primary Blue
- Sky Blue
- Plum
- Crimson
- Primary Red

Frame

- Black
- Hammertone Black
- Hammertone Gray
- Dark Gray
- Gray
- Metallic
- Chrome
- Beige
- Hunter Green
- Navy Blue
- Burgundy



Shown with optional Book Rack

Marquis

An all-in-one solution, combo desks with the Alumni Marquis Seat and Backrest feature a durable material that resists chipping, scratching and fading.

The Alumni Marquis 4-Leg Combination Desk is available with opposite entry to enable full use of classroom space.

The Alumni Sled Combination Desk design allows for ease of entry for students from either side of the desk.



CD-4LEG-MAR-1824-FRB
Shown with optional Chrome Frame, Front-to-Rear Bracing and Opposite Entry



CD-4LEG-MAR-1824-EB
Shown with optional Extra Bracing

- Standard Plastic Laminate Top with Round Corner PVC Edge or Hard Plastic (HP) Top with Embossed Pencil Groove
- Fully Welded Tubular Steel Frame
- Standard 4-Leg Finish: 100% Polyester Premium Powder Coat
- Standard Sled Finish: Chrome
- 4-Leg Glides: Marquis Nylon Swivel, Marquis Steel Swivel, Marquis Neoprene Swivel, Q-Ball or Quiet Glide
- Sled Glides: Grip Glide
- Options: Book Rack, Bag Hook, CAL 133 Compliant
- 4-Leg Only Options: Opposite Entry, Extra Bracing (EB), or Front-to-Rear Bracing (FRB), Chrome Frame (4-Leg)

Model	Top Size	Height	Wt. (lbs)	Freight Class
CD-4LEG-MAR-1824	18"x24"	18" S. H.	44	300
CD-SLED-MAR-1824	18"x24"	18" S. H.	48	300
CD-4LEG-MAR-1824-EB	18"x24"	18" S. H.	50	300
CD-4LEG-MAR-1824-FRB	18"x24"	18" S. H.	51	300

Marquis Combo Material Selector

Hard Plastic Top

- Dark Walnut
- Mahogany
- Wild Cherry
- Bannister Oak
- Loft Oak
- Golden Oak
- New Age Oak
- Sugar Maple
- Beige Sand
- Cosmic Strandz
- Gray Spectrum
- Gray Sand
- High Rise
- Vapor Strandz
- Sprout Green
- Agave Blue
- Eggplant Purple
- Pomegranate Red

Hard Plastic Seat & Back

- Black
- Charcoal
- Gray
- Hunter Green
- Navy Blue
- Royal Blue
- Burgundy
- Cranberry

Frame

- Black
- Hammertone Black
- Hammertone Gray
- Dark Gray
- Gray
- Metallic
- Chrome
- Beige
- Hunter Green
- Navy Blue
- Burgundy



Tables

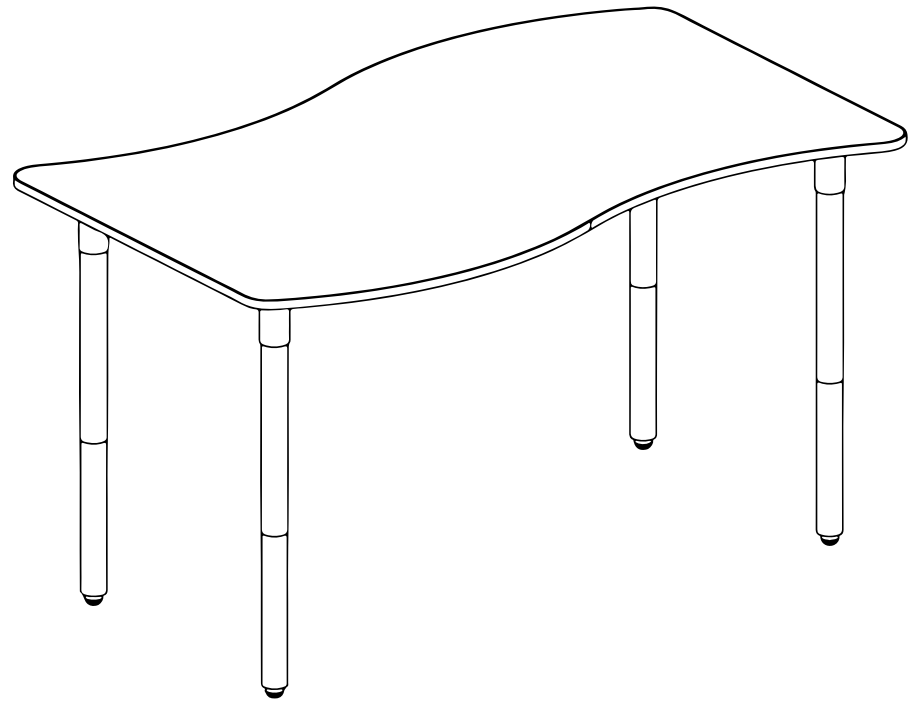

Our assortment of table shapes and sizes recognize a need for a multitude of configurations that function in all educational environments. The array of table construction types address both design and budget considerations.



Tables Honor Roll



Round



Rectangle



Trapezoid



C-Shape



Kidney



Horseshoe



Flower



Clover



I-Frame



Interactive



Stacking



Round

The Alumni Honor Roll Full Frame Round Table takes the wiggle out of learning. These tables offer strength and stability for a wide variety of learning environments and activities.

- Standard Plastic Laminate Top with PVC Edge
- 2" Channel Welded Apron 1 1/8" Square Upper Tube with 1" Square Tube Insert, adjustable height 22"-30"
- Heavy Duty Frame: 3" Channel Welded Apron, 1 1/2" Square Upper Tube with a 1 3/8" Square Tube Insert
- 100% Polyester Premium Powder Coat Finish
- Standard Glides: Adjustable
- Optional Glides: Stainless Steel
- Options: Fixed Height, ADA Height (26"-34"), Standing Height (34"-42"), 3/4" or 1 1/8" High Pressure Laminate (HPL) Top with PVC Edge, 3" Casters, 4" Casters, 3" Heavy Duty Frame, Bag Hook(s), 3" Heavy Duty Frame, Chrome Legs

Model	Top Size	Wt. (lbs)	Freight Class
T-36R	36" DIA	35	KD 70
T-42R	42" DIA	45	KD 70
T-48R	48" DIA	58	KD 70
T-60R	60" DIA	72	KD 70



Rectangle

The Alumni Honor Roll Full Frame Rectangle Table takes the wiggle out of learning. These tables offer strength and stability for a wide variety of learning environments and activities.

- Standard Plastic Laminate Top with Round Corner PVC Edge or Hard Plastic (HP) in limited sizes(*)
- Standard Frame: 2" Channel Welded Apron 1 1/8" Square Upper Tube with 1" Square Tube Insert, adjustable height 22"-30"
- Heavy Duty Frame Standard on 30"x96" Table
- 100% Polyester Premium Powder Coat Finish
- Standard Glides: Adjustable
- Optional Glides: Stainless Steel
- Options: Fixed Height, ADA Height (26"-34"), Standing Height (34"-42"), 3/4" or 1 1/8" High Pressure Laminate (HPL) Top with PVC Edge, 3" Casters, 4" Casters, Bag Hook(s), 3" Heavy Duty Frame, Chrome Legs

Model	Top Size	Wt. (lbs)	Freight Class
T-1824 *	18"x24"	26	KD 70
T-2026 *	20"x26"	27	KD 70
T-2424 *	24"x24"	27	KD 70
T-2430 *	24"x30"	30	KD 70
T-2436	24"x36"	32	KD 70
T-2448	24"x48"	41	KD 70
T-2460	24"x60"	44	KD 70
T-2472	24"x72"	58	KD 70
T-3030	30"x30"	32	KD 70
T-3036	30"x36"	35	KD 70
T-3048	30"x48"	43	KD 70
T-3060	30"x60"	52	KD 70
T-3072	30"x72"	60	KD 70
T-3096	30"x96"	92	KD 70
T-3636	36"x36"	35	KD 70
T-3660	36"x60"	58	KD 70
T-3672	36"x72"	68	KD 70
T-4242	42"x42"	45	KD 70
T-4848	48"x48"	58	KD 70

Trapezoid

The Alumni Honor Roll Full Frame Trapezoid Activity Table takes the wiggle out of learning. These tables offer strength and stability for a wide variety of learning environments and activities.

- Standard Plastic Laminate Top with Round Corner PVC Edge
- 2" Channel Welded Apron 1 1/8" Square Upper Tube with 1" Square Tube Insert, adjustable height 22"-30"
- 100% Polyester Premium Powder Coat Finish
- Standard Glides: Adjustable
- Optional Glides: Stainless Steel
- Options: Fixed Height, ADA Height (26"-34"), Standing Height (34"-42"), 3/4" or 1 1/8" High Pressure Laminate (HPL) Top with PVC Edge, 3" Casters, 4" Casters, 3" Heavy Duty Frame, Bag Hook(s), Chrome Legs

Model	Top Size	Wt. (lbs)	Freight Class
T-24242448	24"x24"x24"x48"	34	KD 70
T-30303060	30"x30"x30"x60"	43	KD 70



C-Shape

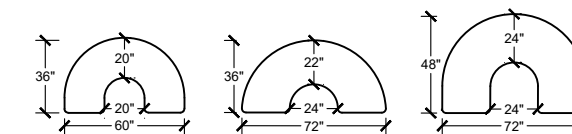

The Alumni Honor Roll Full Frame C-Shape Table takes the wiggle out of learning. These tables offer strength and stability for a wide variety of learning environments and activities. The unique C-Shape Top is designed for guided reading and collaboration.

- Standard Plastic Laminate Top with Round Corner PVC Edge
- 3" Channel Welded Apron, 1 1/2" Square Upper Tube with 1 3/8" Square Tube Insert, adjustable height 22"-30"
- 100% Polyester Premium Powder Coat Finish
- Standard Glides: Adjustable
- Optional Glides: Stainless Steel
- Options: 3/4" or 1 1/8" High Pressure Laminate (HPL) Top with PVC Edge, Fixed Height, ADA Height (26"-34"), Bag Hook(s), 3" Casters, 4" Casters, Chrome Legs

Model	Top Size	Wt. (lbs)	Freight Class
T-3660-CSHAPE	36"x60"	72	KD 70
T-3672-CSHAPE	36"x72"	79	KD 70
T-4872-CSHAPE	48"x72"	83	KD 70





Kidney

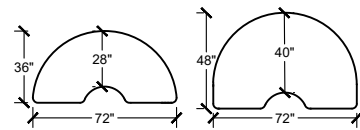

The Alumni Honor Roll Full Frame Kidney Table takes the wiggle out of learning. These tables offer strength and stability for a wide variety of learning environments and activities. The unique Kidney Shape Top is designed for guided reading and collaboration.

- Standard Plastic Laminate Top with Round Corner PVC Edge
- 3" Channel Welded Apron, 1 1/2" Square Upper Tube with 1 3/8" Square Tube Insert, adjustable height 22"-30"
- 100% Polyester Premium Powder Coat Finish
- Standard Glides: Adjustable
- Optional Glides: Stainless Steel
- Options: 3/4" or 1 1/8" High Pressure Laminate (HPL) Top with PVC Edge, Fixed Height, ADA Height (26"-34"), Bag Hook(s), 3" Casters, 4" Casters, Chrome Legs

Model	Top Size	Wt. (lbs)	Freight Class
T-3672-KDNY	36"x72"	76	KD 70
T-4872-KDNY	48"x72"	80	KD 70



Horseshoe

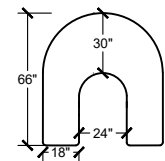

The Alumni Honor Roll Full Frame Horseshoe Table takes the wiggle out of learning. These tables offer strength and stability for a wide variety of learning environments and activities. The unique Horseshoe Top is designed for guided reading and collaboration in larger groups.

- Standard Plastic Laminate Top with Round Corner PVC Edge
- 3" Channel Welded Apron, 1 1/2" Square Upper Tube with 1 3/8" Square Tube Insert, adjustable height 22"-30"
- 100% Polyester Premium Powder Coat Finish
- Standard Glides: Adjustable
- Optional Glides: Stainless Steel
- Options: 3/4" or 1 1/8" High Pressure Laminate (HPL) Top with PVC Edge, Fixed Height, ADA Height (26"-34"), Bag Hook(s), 3" Casters, 4" Casters, Chrome Legs

Model	Top Size	Wt. (lbs)	Freight Class
T-6066-HS	60"x66"	92	KD 70



Flower

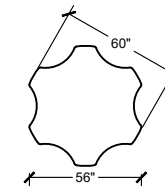

The Alumni Honor Roll Full Frame Flower Table takes the wiggle out of learning. These tables offer strength and stability for a wide variety of learning environments and activities. The unique Flower Top is designed for guided reading and collaboration.

- Standard Plastic Laminate Top with Round Corner PVC Edge
- 3" Channel Welded Apron, 1 1/2" Square Upper Tube with 1 3/8" Square Tube Insert, adjustable height 22"-30"
- 100% Polyester Premium Powder Coat Finish
- Standard Glides: Adjustable
- Optional Glides: Stainless Steel
- Options: 3/4" or 1 1/8" High Pressure Laminate (HPL) Top with PVC Edge, Fixed Height, ADA Height (26"-34"), Bag Hook(s), 3" Casters, 4" Casters, Chrome Legs

Model	Top Size	Wt. (lbs)	Freight Class
T-60FL	60" DIA	65	KD 70



Clover

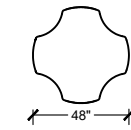

The Alumni Honor Roll Full Frame Clover Tables take the wiggle out of learning. These tables offer strength and stability for a wide variety of learning environments and activities. The unique Clover Shape Top is designed for guided reading and collaboration.

- Standard Plastic Laminate Top with Round Corner PVC Edge
- 2" Channel Welded Apron 1 1/8" Square Upper Tube with 1" Square Tube Insert, adjustable height 22"-30"
- 100% Polyester Premium Powder Coat Finish
- Standard Glides: Adjustable
- Optional Glides: Stainless Steel
- Options: 3/4" or 1 1/8" High Pressure Laminate (HPL) Top with PVC Edge, Fixed Height, ADA Height (26"-34"), Bag Hook(s), 3" Casters, 4" Casters, 3" Heavy Duty Frame, Chrome Legs

Model	Top Size	Wt. (lbs)	Freight Class
T-48CL	48" DIA	42	KD 70





Shown with optional Solid Steel Book Boxes

I-Frame

The Alumni I-Frame Activity Table takes the wiggle out of learning. These tables offer strength and stability for a wide variety of learning environments and activities.

- 3/4" or 1 1/8" High Pressure Laminate (HPL) Top with Round Corner PVC Edge or Hard Plastic (HP) in limited sizes(*)
- 2"x1" All Welded Table Frame Welded to Four 1 1/8" Legs with Chrome Inserts, adjustable height 22"-30"
- 100% Polyester Premium Powder Coat Finish
- Standard Glides: Adjustable
- Optional Glides: Stainless Steel
- Options: Fixed Height, ADA Height (26"-34"), Solid or Perforated Steel Book Box(es), Polypropylene Book Box(es), 3" Casters, 4" Casters, or Bag Hook(s)

Model	Top Size	Wt. (lbs)	Freight Class
TW-I-FRAME-1824*	18"x24"	31	150
TW-I-FRAME-2026	20"x26"	32	150
TW-I-FRAME-2424*	24"x24"	32	150
TW-I-FRAME-2430*	24"x30"	35	150
TW-I-FRAME-2436	24"x36"	37	150
TW-I-FRAME-2448	24"x48"	46	150
TW-I-FRAME-2460	24"x60"	49	150
TW-I-FRAME-2472	24"x72"	62	150
TW-I-FRAME-3030	30"x30"	37	150
TW-I-FRAME-3036	30"x36"	40	150
TW-I-FRAME-3048	30"x48"	48	150
TW-I-FRAME-3060	30"x60"	57	150
TW-I-FRAME-3072	30"x72"	65	150
TW-I-FRAME-3636	36"x36"	40	150
TW-I-FRAME-3660	36"x60"	63	150
TW-I-FRAME-3672	36"x72"	73	150
TW-I-FRAME-4242	42"x42"	50	150
TW-I-FRAME-4848	48"x48"	63	150
TW-I-FRAME-36R	36" DIA	40	150
TW-I-FRAME-42R	42" DIA	50	150
TW-I-FRAME-48R	48" DIA	63	150
TW-I-FRAME-60R	60" DIA	77	150
TW-I-FRAME-24242448	24"x24"x24"x48"	39	150
TW-I-FRAME-30303060	30"x30"x30"x60"	48	150



Interactive

The Alumni Interactive Tables are contemporary, versatile and practical as a two-student or activity table. They can be arranged for both partnered and collaborative learning; three tables can fit together to accommodate six students in its ideal configuration.

- Standard Plastic Laminate Top with Round Corner PVC Edge
- 2" Channel Welded Apron, 1 1/8" Square Upper Tube with 1" Square Tube Insert, adjustable height 22"-30"
- 100% Polyester Premium Powder Coat Finish
- Standard Glides: Adjustable
- Optional Glides: Stainless Steel
- Options: Chrome Legs, 3/4" or 1 1/8" High Pressure Laminate (HPL) Top with PVC Edge, Fixed Height, ADA Height (26"-34"), Bag Hook(s), 3" Casters, 4" Casters

Model	Top Size	Wt. (lbs)	Freight Class
T-INTERAC-2940	29"x40"	34	KD 70
T-INTERAC-3550	35"x50"	38	KD 70

Honor Roll Material Selector

Laminate Top

- Dark Walnut
- Mahogany
- Wild Cherry
- Bannister Oak
- Loft Oak
- New Age Oak
- Sugar Maple
- Cosmic Strandz
- Gray Spectrum
- High Rise
- Vapor Strandz
- Sprout Green
- Agave Blue
- Eggplant Purple
- Pomegranate Red
- Primary Yellow
- Primary Green
- Primary Blue
- Primary Red

PVC Edge

- Black
- Charcoal
- Warm Gray
- Gray
- Maple
- Beige
- Pumpkin
- Primary Yellow
- Primary Green
- Apple Green
- Navy Blue
- Primary Blue
- Sky Blue
- Plum
- Crimson
- Primary Red

Frame

- Black
- Hammertone Black
- Hammertone Gray
- Dark Gray
- Gray
- Metallic
- Chrome
- Beige
- Hunter Green
- Navy Blue
- Burgundy



Stacking

The Alumni Honor Roll Stacking Tables are a space saving solution. These heavy gauge, fully-welded tables stack neatly and compactly. Effortless stacking design allows for tables to slide onto one another without lifting up and over. Four leveling bumpers on the underside of each table prevents scratching and scuffing when stacking.

- 3/4" or 1 1/8" High Pressure Laminate (HPL) Top with Square Corner PVC Edge
- Welded Table Frame and Legs Consist of Four 1 1/8" Tube
- Fixed Height 30"
- Chrome Finish
- Standard Glides: Vinyl Insert

Model	Top Size	Wt. (lbs)	Freight Class
T-STACK-1824-FX30	18"x24"	22	125
T-STACK-1832-FX30	18"x32"	25	125
T-STACK-2430-FX30	24"x30"	28	125



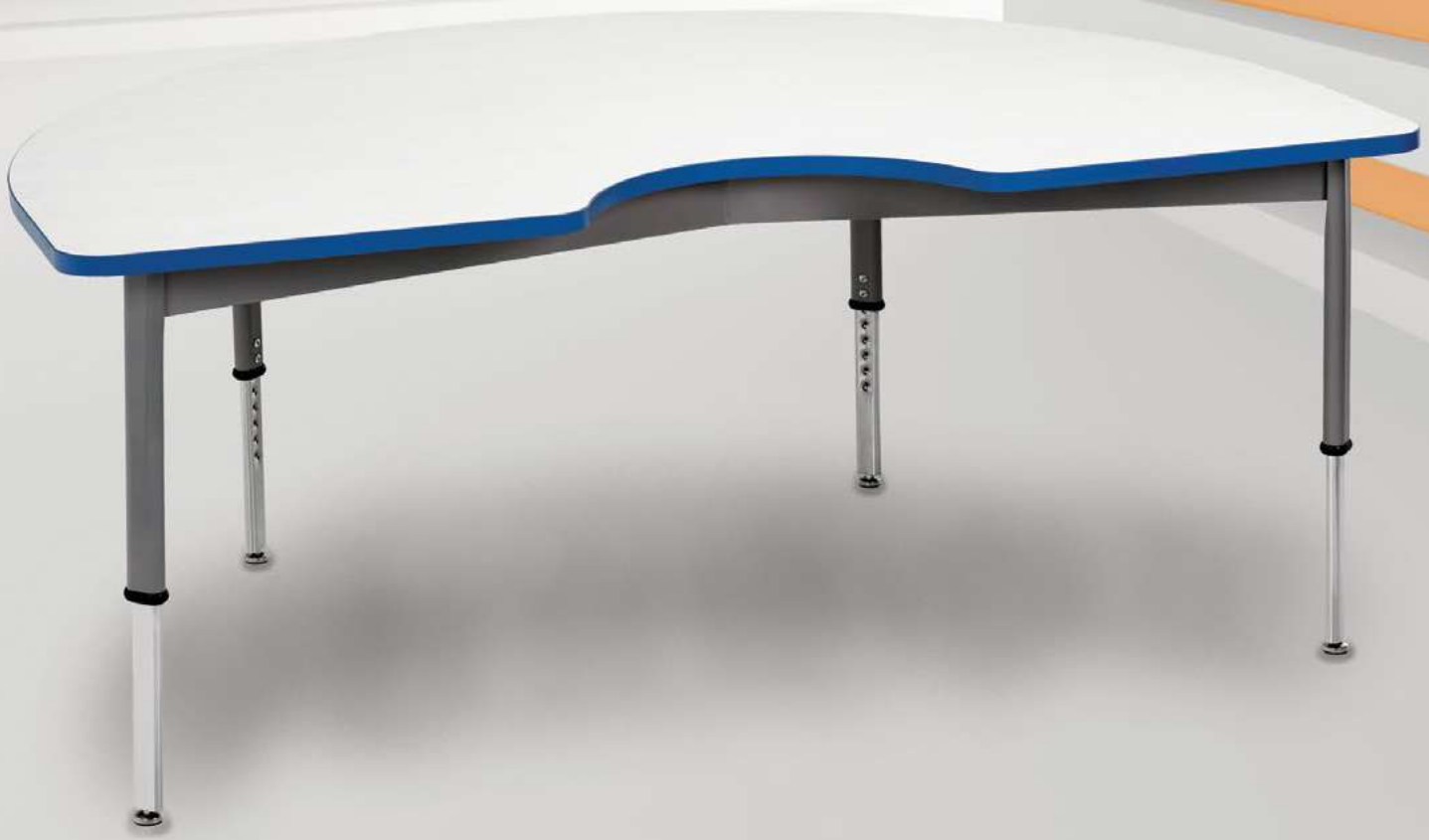

Round



Rectangle



Trapezoid



C-Shape



Kidney



Horseshoe



Flower



Clover



D-Shape



Interactive Cafe Height



Round



Rectangle



Trapezoid

The *Alumni Integrity Full Frame Trapezoid Table* offers strength and stability for a wide variety of learning environments and activities.

- 3/4" or 1 1/8" High Pressure Laminate (HPL) Top with Round Corner PVC Edge
- 2" Channel Welded Apron, 2"x1 1/4" Upright Oval Tubes with Chrome Insert Tubes, adjustable height 22"-30"
- 100% Polyester Premium Powder Coat Finish
- Standard Glides: Adjustable
- Optional Glides: Stainless Steel
- Options: Fixed Height, ADA Height (26"-34"), Standing Height (34"-42"), 3" Casters, 4" Casters, 3" Heavy Duty Frame, Bag Hook(s)

Model	Top Size	Wt. (lbs)	Freight Class
T-OVAL-24242448	24"x24"x24"x48"	37	KD 70
T-OVAL-30303060	30"x30"x30"x60"	46	KD 70

The *Alumni Integrity Full Frame Round Table* offers strength and stability for a wide variety of learning environments and activities.

- 3/4" or 1 1/8" High Pressure Laminate (HPL) Top with Round Corner PVC Edge
- 2" Channel Welded Apron, 2"x1 1/4" Upright Oval Tubes with Chrome Insert Tubes, adjustable height 22"-30"
- Heavy Duty Frame: 3" Channel Welded Apron, 2"x1 1/4" Upright Oval Tubes with Chrome Insert Tubes
- 100% Polyester Premium Powder Coat Finish
- Standard Glides: Adjustable
- Optional Glides: Stainless Steel
- Options: Fixed Height, ADA Height (26"-34"), Standing Height (34"-42"), 3" Casters, 4" Casters, 3" Heavy Duty Frame, Bag Hook(s)

Model	Top Size	Wt. (lbs)	Freight Class
T-OVAL-36R	36" DIA	39	KD 70
T-OVAL-42R	42" DIA	48	KD 70
T-OVAL-48R	48" DIA	61	KD 70
T-OVAL-60R	60" DIA	76	KD 70

The *Alumni Integrity Full Frame Rectangle Table* offers strength and stability for a wide variety of learning environments and activities.

- 3/4" or 1 1/8" High Pressure Laminate (HPL) Top with Round Corner PVC Edge or Hard Plastic (HP) in limited sizes(*)
- 2" Channel Welded Apron, 2"x1 1/4" Upright Oval Tubes with Chrome Insert Tubes, adjustable height 22"-30"
- Heavy Duty Frame Standard on 30"x96" Table
- 100% Polyester Premium Powder Coat Finish
- Standard Glides: Adjustable
- Optional Glides: Stainless Steel
- Options: Fixed Height, ADA Height (26"-34"), Standing Height (34"-42"), 3" Casters, 4" Casters, Bag Hook(s), 3" Heavy Duty Frame

Model	Top Size	Wt. (lbs)	Freight Class
T-OVAL-1824 *	18"x24"	29	KD 70
T-OVAL-2026 *	20"x26"	29	KD 70
T-OVAL-2424 *	24"x24"	30	KD 70
T-OVAL-2430 *	24"x30"	33	KD 70
T-OVAL-2436	24"x36"	36	KD 70
T-OVAL-2448	24"x48"	44	KD 70
T-OVAL-2460	24"x60"	47	KD 70
T-OVAL-2472	24"x72"	62	KD 70
T-OVAL-3030	30"x30"	36	KD 70
T-OVAL-3036	30"x36"	39	KD 70
T-OVAL-3048	30"x48"	46	KD 70
T-OVAL-3060	30"x60"	55	KD 70
T-OVAL-3072	30"x72"	63	KD 70
T-OVAL-3096	30"x96"	100	KD 70
T-OVAL-3636	36"x36"	39	KD 70
T-OVAL-3660	36"x60"	61	KD 70
T-OVAL-3672	36"x72"	71	KD 70
T-OVAL-4242	42"x42"	49	KD 70
T-OVAL-4848	48"x48"	62	KD 70



C-Shape

The *Alumni Integrity 4-Leg Full Frame C-Shape Table* offers strength and stability for a wide variety of learning environments and activities.

- 3/4" or 1 1/8" High Pressure Laminate (HPL) Top with Round Corner PVC Edge
- 3" Channel Welded Apron, 2"x1 1/4" Upright Oval Tubes with Chrome Insert Tubes, adjustable height 22"-30"
- 100% Polyester Premium Powder Coat Finish
- Standard Glides: Adjustable
- Optional Glides: Stainless Steel
- Options: Fixed Height, ADA Height (26"-34"), Standing Height (34"-42"), 3" Casters, 4" Casters, Bag Hook(s)

Model	Top Size	Wt. (lbs)	Freight Class
T-OVAL-3660CSHAPE	36"x60"	77	KD 70
T-OVAL-3672CSHAPE	36"x72"	84	KD 70
T-OVAL-4872CSHAPE	48"x72"	88	KD 70

*See page 131 for Top Size Diagrams



Kidney

The *Alumni Integrity Full Frame Kidney Table* offers strength and stability for a wide variety of learning environments and activities.

- 3/4" or 1 1/8" High Pressure Laminate (HPL) Top with Round Corner PVC Edge
- 3" Channel Welded Apron, 2"x1 1/4" Upright Oval Tubes with Chrome Insert Tubes, adjustable height 22"-30"
- 100% Polyester Premium Powder Coat Finish
- Standard Glides: Adjustable
- Optional Glides: Stainless Steel
- Options: Fixed Height, ADA Height (26"-34"), Standing Height (34"-42"), 3" Casters, 4" Casters, Bag Hook(s)

Model	Top Size	Wt. (lbs)	Freight Class
T-OVAL-3672KDNY	36"x72"	80	KD 70
T-OVAL-4872KDNY	48"x72"	84	KD 70

*See page 132 for Top Size Diagrams





Horseshoe

The Alumni Integrity Full Frame Horseshoe Table offers strength and stability for a wide variety of learning environments and activities.

- 3/4" or 1 1/8" High Pressure Laminate (HPL) Top with Round Corner PVC Edge
- 3" Channel Welded Apron, 2"x1 1/4" Upright Oval Tubes with Chrome Insert Tubes, adjustable height 22"-30"
- 100% Polyester Premium Powder Coat Finish
- Standard Glides: Adjustable
- Optional Glides: Stainless Steel
- Options: Fixed Height, ADA Height (26"-34"), Standing Height (34"-42"), 3" Casters, 4" Casters, Bag Hook(s)

Model	Top Size	Wt. (lbs)	Freight Class
T-OVAL-6066HS	60"x66"	96	KD 70

*See page 132 for Top Size Diagram



Flower

The Alumni Integrity Full Frame Flower Table takes offers strength and stability for a wide variety of learning environments and activities.

- 3/4" or 1 1/8" High Pressure Laminate (HPL) Top with Round Corner PVC Edge
- 3" Channel Welded Apron, 2"x1 1/4" Upright Oval Tubes with Chrome Insert Tubes, adjustable height 22"-30"
- 100% Polyester Premium Powder Coat Finish
- Standard Glides: Adjustable
- Optional Glides: Stainless Steel
- Options: Fixed Height, ADA Height (26"-34"), Standing Height (34"-42"), 3" Casters, 4" Casters, Bag Hook(s)

Model	Top Size	Wt. (lbs)	Freight Class
T-OVAL-60FL	60" DIA	73	KD 70

*See page 133 for Top Size Diagram



Clover

The Alumni Integrity Full Frame Clover Table takes the wiggle out of learning. These tables offer strength and stability for a wide variety of learning environments and activities. Available in many shapes and sizes.

- 3/4" or 1 1/8" High Pressure Laminate (HPL) Top with Round Corner PVC Edge
- 2" Channel Welded Apron, 2"x1 1/4" Upright Oval Tubes with Chrome Insert Tubes, adjustable height 22"-30"
- 100% Polyester Premium Powder Coat Finish
- Standard Glides: Adjustable
- Optional Glides: Stainless Steel
- Options: Fixed Height, ADA Height (26"-34"), Standing Height (34"-42"), 3" Casters, 4" Casters, 3" Heavy Duty Frame, Bag Hook(s)

Model	Top Size	Wt. (lbs)	Freight Class
T-OVAL-48CL	48" DIA	46	KD 70

*See page 133 for Top Size Diagram



D-Shape

The Alumni Integrity Full Frame D-Shape Table offers strength and stability for a wide variety of learning environments and activities.

- 3/4" or 1 1/8" High Pressure Laminate (HPL) Top with Round Corner PVC Edge
- 3" Channel Welded Apron, 2"x1 1/4" Upright Oval Tubes with Chrome Insert Tubes, adjustable height 22"-30"
- 100% Polyester Premium Powder Coat Finish
- Standard Glides: Adjustable
- Optional Glides: Stainless Steel
- Options: Fixed Height, ADA Height (26"-34"), Standing Height (34"-42"), 3" Casters, 4" Casters, Bag Hook(s)

Model	Top Size	Wt. (lbs)	Freight Class
T-OVAL-4460DSHAPE	44"x60"	84	KD 70
T-OVAL-4472DSHAPE	44"x72"	86	KD70

*See page 154 for Top Size Diagrams



Interactive Cafe Height

The Alumni Interactive Cafe Height Tables are contemporary, versatile and practical as a cafe height activity table. They can be arranged for both partnered and collaborative learning. The large work surface makes this table great for group activities. Three tables can be fit together to accommodate six students in its ideal configuration. Ideal for use with Cafe Height Stools.

- 3/4" or 1 1/8" High Pressure Laminate (HPL) Top with Round Corner PVC Edge
- Full Perimeter 3/4" Steel Tubing Welded to Four 1 1/2" Leg Mounts, 2"x1 1/4" Upright Oval Tubes with Chrome Insert Tubes, fixed height 42"
- 100% Polyester Premium Powder Coat Finish
- Standard Glides: Adjustable
- Optional Glides: Stainless Steel
- Options: Bag Hook, Adjustable Height (34"-42")

Model	Top Size	Wt. (lbs)	Freight Class
T-CAFE-INTERAC-3550	35"x50"	40	KD 70

Integrity Material Selector

Laminate Top

- Dark Walnut
- Mahogany
- Wild Cherry
- Bannister Oak
- Loft Oak
- New Age Oak
- Sugar Maple
- Cosmic Strandz
- Gray Spectrum
- High Rise
- Vapor Strandz
- Sprout Green
- Agave Blue
- Eggplant Purple
- Pomegranate Red
- Primary Yellow
- Primary Green
- Primary Blue
- Primary Red

PVC Edge

- Black
- Charcoal
- Warm Gray
- Gray
- Maple
- Beige
- Pumpkin
- Primary Yellow
- Primary Green
- Apple Green
- Navy Blue
- Primary Blue
- Sky Blue
- Plum
- Crimson
- Primary Red

Frame

- Black
- Hammertone Black
- Hammertone Gray
- Dark Gray
- Gray
- Metallic
- Beige
- Navy Blue
- Burgundy
- Hunter Green



Tables Creativity



Round



Rectangle



Trapezoid



C-Shape



Kidney



Horseshoe



Flower



Clover



Spur



Hex



Round



Rectangle

The Alumni Creativity Round Table features a 1 1/8" High Pressure Laminate writing surface. Welded V-Shaped support braces and mounting plates offer strength and stability.

- 1 1/8" High Pressure Laminate (HPL) Top with Round Corner PVC Edge
- 1 1/4" Round Tube with 1" Round Tube Insert, adjustable height 22"-30"
- 100% Polyester Premium Powder Coat Finish
- Standard Glides: Marquis Adjustable Nylon
- Optional Glides: Marquis Adjustable Steel, Felt Snap-On, Q-Ball or Quiet Glide
- Options: ADA Height (26"-34"), Standing Height (34"-42")

Model	Top Size	Wt. (lbs)	Freight Class
TN-36R-ADJ	36" DIA	40	KD 70
TN-42R-ADJ	42" DIA	52	KD 70
TN-48R-ADJ	48" DIA	61	KD 70
TN-60R-ADJ	60" DIA	90	KD 70

The Alumni Creativity Rectangle Table features a 1 1/8" High Pressure Laminate writing surface. Welded V-Shaped support braces and mounting plates offer strength and stability.

- 1 1/8" High Pressure Laminate (HPL) Top with Round Corner PVC Edge
- 1 1/4" Round Tube with 1" Round Tube Insert, adjustable height 22"-30"
- 100% Polyester Premium Powder Coat Finish
- Standard Glides: Marquis Adjustable Nylon
- Optional Glides: Marquis Adjustable Steel, Felt Snap-On, Q-Ball or Quiet Glide
- Options: ADA Height (26"-34"), Standing Height (34"-42")

Model	Top Size	Wt. (lbs)	Freight Class
TN-1824-ADJ*	18"x24"	30	KD 70
TN-2026-ADJ*	20"x26"	30	KD 70
TN-2424-ADJ*	24"x24"	31	KD 70
TN-2430-ADJ*	24"x30"	34	KD 70
TN-2436-ADJ	24"x36"	37	KD 70
TN-2448-ADJ	24"x48"	44	KD 70
TN-2460-ADJ	24"x60"	53	KD 70
TN-2472-ADJ	24"x72"	67	KD 70
TN-3030-ADJ	30"x30"	38	KD 70
TN-3036-ADJ	30"x36"	40	KD 70
TN-3048-ADJ	30"x48"	43	KD 70
TN-3060-ADJ	30"x60"	62	KD 70
TN-3072-ADJ	30"x72"	69	KD 70
TN-3636-ADJ	36"x36"	42	KD 70
TN-3660-ADJ	36"x60"	64	KD 70
TN-3672-ADJ	36"x72"	79	KD 70
TN-4242-ADJ	42"x42"	54	KD 70
TN-4848-ADJ	48"x48"	64	KD 70



Trapezoid

The Alumni Creativity Trapezoid Table features a 1 1/8" High Pressure Laminate writing surface. Welded V-Shaped support braces and mounting plates offer strength and stability.

- 1 1/8" High Pressure Laminate (HPL) Top with Round Corner PVC Edge
- 1 1/4" Round Tube with 1" Round Tube Insert, adjustable height 22"-30"
- 100% Polyester Premium Powder Coat Finish
- Standard Glides: Marquis Adjustable Nylon
- Optional Glides: Marquis Adjustable Steel, Felt Snap-On, Q-Ball or Quiet Glide
- Options: ADA Height (26"-34"), Standing Height (34"-42")

Model	Top Size	Wt. (lbs)	Freight Class
TN-24242448	24"x24"x24"x48"	32	KD 70
TN-30303060	30"x30"x30"x60"	37	KD 70



C-Shape

The Alumni Creativity C-Shape Table features a 1 1/8" High Pressure Laminate writing surface. Welded V-Shaped support braces and mounting plates offer strength and stability.

- 1 1/8" High Pressure Laminate (HPL) Top with Round Corner PVC Edge
- 1 1/4" Round Tube with 1" Round Tube Insert, adjustable height 22"-30"
- 100% Polyester Premium Powder Coat Finish
- Standard Glides: Marquis Adjustable Nylon
- Optional Glides: Marquis Adjustable Steel, Felt Snap-On, Q-Ball or Quiet Glide
- Options: ADA Height (26"-34"), Standing Height (34"-42")

Model	Top Size	Wt. (lbs)	Freight Class
TN-3660CSHAPE	36"x60"	75	KD 70
TN-3672CSHAPE	36"x72"	83	KD 70
TN-4872CSHAPE	48"x72"	87	KD 70

*See page 131 for Top Size Diagram



Kidney

The Alumni Creativity Kidney Table features a 1 1/8" High Pressure Laminate writing surface. Welded V-Shaped support braces and mounting plates offer strength and stability.

- 1 1/8" High Pressure Laminate (HPL) Top with Round Corner PVC Edge
- 1 1/4" Round Tube with 1" Round Tube Insert, adjustable height 22"-30"
- 100% Polyester Premium Powder Coat Finish
- Standard Glides: Marquis Adjustable Nylon
- Optional Glides: Marquis Adjustable Steel, Felt Snap-On, Q-Ball or Quiet Glide
- Options: ADA Height (26"-34"), Standing Height (34"-42")

Model	Top Size	Wt. (lbs)	Freight Class
TN-3672KDNY	36"x72"	76	KD 70
TN-4872KDNY	48"x72"	80	KD 70

*See page 132 for Top Size Diagram



Horseshoe

The Alumni Creativity Horseshoe Table features a 1 1/8" High Pressure Laminate writing surface. Welded V-Shaped support braces and mounting plates offer strength and stability.

- 1 1/8" High Pressure Laminate (HPL) Top with Round Corner PVC Edge
- 1 1/4" Round Tube with 1" Round Tube Insert, adjustable height 22"-30"
- 100% Polyester Premium Powder Coat Finish
- Standard Glides: Marquis Adjustable Nylon
- Optional Glides: Marquis Adjustable Steel, Felt Snap-On, Q-Ball or Quiet Glide
- Options: ADA Height (26"-34"), Standing Height (34"-42")

Model	Top Size	Wt. (lbs)	Freight Class
TN-6066HS	60"x66"	92	KD 70

*See page 132 for Top Size Diagram



Flower

The Alumni Creativity Flower Table features a 1 1/8" High Pressure Laminate writing surface. Welded V-Shaped support braces and mounting plates offer strength and stability.

- 1 1/8" High Pressure Laminate (HPL) Top with Round Corner PVC Edge
- 1 1/4" Round Tube with 1" Round Tube Insert, adjustable height 22"-30"
- 100% Polyester Premium Powder Coat Finish
- Standard Glides: Marquis Adjustable Nylon
- Optional Glides: Marquis Adjustable Steel, Felt Snap-On, Q-Ball or Quiet Glide
- Options: ADA Height (26"-34"), Standing Height (34"-42")

Model	Top Size	Wt. (lbs)	Freight Class
TN-60FL	60" DIA	86	KD 70

*See page 133 for Top Size Diagram



Clover

The Alumni Creativity Clover Table features a 1 1/8" High Pressure Laminate writing surface. Welded V-Shaped support braces and mounting plates offer strength and stability.

- 1 1/8" High Pressure Laminate (HPL) Top with Round Corner PVC Edge
- 1 1/4" Round Tube with 1" Round Tube Insert, adjustable height 22"-30"
- 100% Polyester Premium Powder Coat Finish
- Standard Glides: Marquis Adjustable Nylon
- Optional Glides: Marquis Adjustable Steel, Felt Snap-On, Q-Ball or Quiet Glide
- Options: ADA Height (26"-34"), Standing Height (34"-42")

Model	Top Size	Wt. (lbs)	Freight Class
TN-48CL	48" DIA	64	KD 70

*See page 132 for Top Size Diagram



Spur

The Alumni Creativity Spur Table features a 1 1/8" High Pressure Laminate writing surface. Welded V-Shaped support braces and mounting plates offer strength and stability.

- 1 1/8" High Pressure Laminate (HPL) Top with Round Corner PVC Edge
- 1 1/4" Round Tube with 1" Round Tube Insert, adjustable height 22"-30"
- 100% Polyester Premium Powder Coat Finish
- Standard Glides: Marquis Adjustable Nylon
- Optional Glides: Marquis Adjustable Steel, Felt Snap-On, Q-Ball or Quiet Glide
- Options: ADA Height (26"-34"), Standing Height (34"-42")

Model	Top Size	Wt. (lbs)	Freight Class
TN-48SPUR	48" DIA	82	KD 70

*See page 153 for Top Size Diagram



Hex

The Alumni Creativity Hex Table features a 1 1/8" High Pressure Laminate writing surface. Welded V-Shaped support braces and mounting plates offer strength and stability.

- 1 1/8" High Pressure Laminate (HPL) Top with Round Corner PVC Edge
- 1 1/4" Round Tube with 1" Round Tube Insert, adjustable height 22"-30"
- 100% Polyester Premium Powder Coat Finish
- Standard Glides: Marquis Adjustable Nylon
- Optional Glides: Marquis Adjustable Steel, Felt Snap-On, Q-Ball or Quiet Glide
- Options: ADA Height (26"-34"), Standing Height (34"-42")

Model	Top Size	Wt. (lbs)	Freight Class
TN-60HEX	60" DIA	88	KD 70

*See page 153 Top Size Diagram

4-Leg Creativity Material Selector

Laminate Top

- | | | | | | | |
|---------------|-----------------|------------------|-----------------|-------------------|------------------|---------------|
| • Dark Walnut | • Bannister Oak | • Sugar Maple | • High Rise | • Agave Blue | • Primary Yellow | • Primary Red |
| • Mahogany | • Loft Oak | • Cosmic Strandz | • Vapor Strandz | • Eggplant Purple | • Primary Green | |
| • Wild Cherry | • New Age Oak | • Gray Spectrum | • Sprout Green | • Pomegranate Red | • Primary Blue | |

PVC Edge

- | | | | |
|-------------|------------------|-----------------|---------------|
| • Black | • Maple | • Primary Green | • Sky Blue |
| • Charcoal | • Beige | • Apple Green | • Plum |
| • Warm Gray | • Pumpkin | • Navy Blue | • Crimson |
| • Gray | • Primary Yellow | • Primary Blue | • Primary Red |

Leg

- Metallic



Ogee Tables



Zephyr



Raindrop



Puzzle



Six-Sigma



Cloud



Star



Hex



Spur



D-Shape



Clover



Flower



Traditional



Guided Reading



Two Cirrus and One Breeze Configuration

Ogee Tables

Ogee is defined as having a double continuous S-Shaped curve. The Alumni Inspire Ogee Tables offer an interactive and creative table solution for any learning environment. The unique curve design allows for endless configuration possibilities and seating capacities. Available in Rectangle (Breeze), Half-Round (Cirrus), Triangle (Chinook) and Square (Wave) Shapes

- 1 1/8" High Pressure Laminate (HPL) Top with Round Corner PVC Edge
- 2" Round Tube with 1 7/8" Round Insert, adjustable height 22"-30"
- 100% Polyester Premium Powder Coat Finish
- Standard Glides: Adjustable
- Optional Glides: Stainless Steel
- Options: 3" Casters, ADA Height (26"-34"), Standing Height (34"-42")

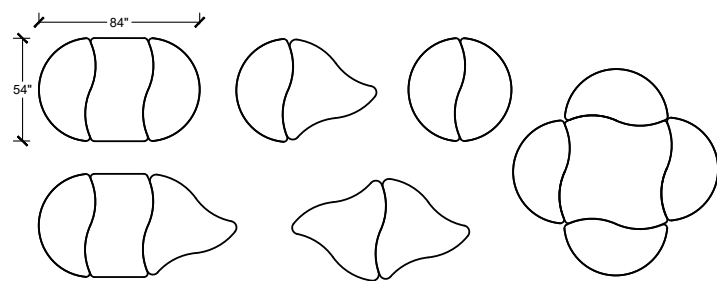

Model	Top Size	Wt. (lbs)	Freight Class
TN-INSP-OGEEBR	30"x54"	65	KD 70
TN-INSP-OGEECS	30"x54"	53	KD 70
TN-INSP-OGEECH	54"x54"x54"	53	KD 70
TN-INSP-OGEEWA	54"x54"	74	KD 70

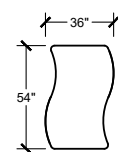

Ogee Breeze

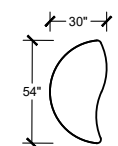

Ogee Cirrus

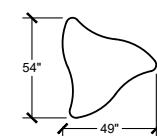

Ogee Chinook

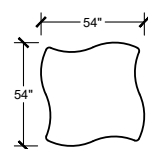

Ogee Wave

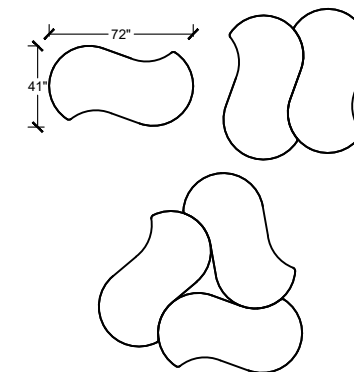

Zephyr

The Alumni Inspire Zephyr Table is designed for guided reading and collaboration. These tables offer strength and stability for a wide variety of learning environments and activities.

- 1 1/8" High Pressure Laminate (HPL) Top with Round Corner PVC Edge
- 2" Round Tube with 1 7/8" Round Insert, adjustable height 22"-30"
- 100% Polyester Premium Powder Coat Finish
- Standard Glides: Adjustable
- Optional Glides: Stainless Steel
- Options: 3" Casters, ADA Height (26"-34"), Standing Height (34"-42")

Model	Top Size	Wt. (lbs)	Freight Class
TN-INSP-4172ZEPH	41"x72"	82	KD 70

Raindrop

The Alumni Inspire Raindrop Table is designed for guided reading and collaboration. These tables offer strength and stability for a wide variety of learning environments and activities.

- 1 1/8" High Pressure Laminate (HPL) Top with Round Corner PVC Edge
- 2" Round Tube with 1 7/8" Round Insert, adjustable height 22"-30"
- 100% Polyester Premium Powder Coat Finish
- Standard Glides: Adjustable
- Optional Glides: Stainless Steel
- Options: 3" Casters, ADA Height (26"-34"), Standing Height (34"-42")

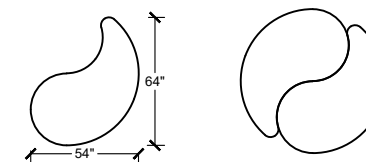

Model	Top Size	Wt. (lbs)	Freight Class
TN-INSP-5464RAIN	54"x64"	78	KD 70



Puzzle

The *Alumni Inspire Puzzle Table* is designed for guided reading and collaboration. These tables offer strength and stability for a wide variety of learning environments and activities.

- 1 1/8" High Pressure Laminate (HPL) Top with Round Corner PVC Edge
- 2" Round Tube with 1 7/8" Round Insert, adjustable height 22"-30"
- 100% Polyester Premium Powder Coat Finish
- Standard Glides: Adjustable
- Optional Glides: Stainless Steel
- Options: 3" Casters, ADA Height (26"-34"), Standing Height (34"-42")

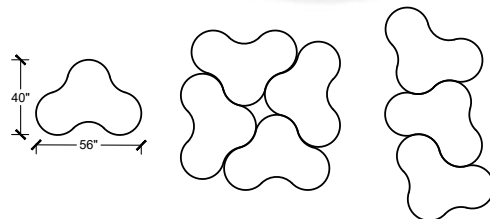

Model	Top Size	Wt. (lbs)	Freight Class
TN-INSP-4056-PUZZLE	40"x56"	68	KD 70

Six-Sigma



The *Alumni Inspire Six-Sigma Table* is designed for guided reading and collaboration. These tables offer strength and stability for a wide variety of learning environments and activities.

- 1 1/8" High Pressure Laminate (HPL) Top with Round Corner PVC Edge
- 2" Round Tube with 1 7/8" Round Insert, adjustable height 22"-30"
- 100% Polyester Premium Powder Coat Finish
- Standard Glides: Adjustable
- Optional Glides: Stainless Steel
- Options: 3" Casters, ADA Height (26"-34"), Standing Height (34"-42")

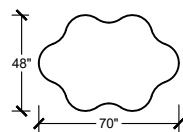

Model	Top Size	Wt. (lbs)	Freight Class
TN-INSP-4870SIXSIGMA	48"x70"	82	KD 70

Cloud



The *Alumni Inspire Cloud Table* is designed for guided reading and collaboration. These tables offer strength and stability for a wide variety of learning environments and activities.

- 1 1/8" High Pressure Laminate (HPL) Top with Round Corner PVC Edge
- 2" Round Tube with 1 7/8" Round Insert, adjustable height 22"-30"
- 100% Polyester Premium Powder Coat Finish
- Standard Glides: Adjustable
- Optional Glides: Stainless Steel
- Options: 3" Casters, ADA Height (26"-34"), Standing Height (34"-42")

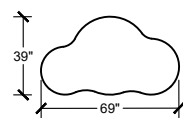

Model	Top Size	Wt. (lbs)	Freight Class
TN-INSP-3969CLOUD	39"x69"	64	KD 70



Star

The *Alumni Inspire Star Table* is designed for guided reading and collaboration. These tables offer strength and stability for a wide variety of learning environments and activities.

- 1 1/8" High Pressure Laminate (HPL) Top with Round Corner PVC Edge
- 2" Round Tube with 1 7/8" Round Insert, adjustable height 22"-30"
- 100% Polyester Premium Powder Coat Finish
- Standard Glides: Adjustable
- Optional Glides: Stainless Steel
- Options: 3" Casters, ADA Height (26"-34"), Standing Height (34"-42")

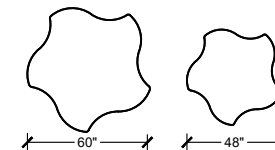

Model	Top Size	Wt. (lbs)	Freight Class
TN-INSP-48STAR	48	55	KD 70
TN-INSP-60STAR	60	60	KD 70



Hex

The *Alumni Inspire Hex Table* is designed for guided reading and collaboration. These tables offer strength and stability for a wide variety of learning environments and activities.

- 1 1/8" High Pressure Laminate (HPL) Top with Round Corner PVC Edge
- 2" Round Tube with 1 7/8" Round Insert, adjustable height 22"-30"
- 100% Polyester Premium Powder Coat Finish
- Standard Glides: Adjustable
- Optional Glides: Stainless Steel
- Options: 3" Casters, ADA Height (26"-34"), Standing Height (34"-42")

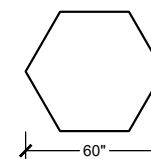

Model	Top Size	Wt. (lbs)	Freight Class
TN-INSP-60HEX	60" DIA	89	KD 70



Spur

The *Alumni Inspire Spur Table* is designed for guided reading and collaboration. These tables offer strength and stability for a wide variety of learning environments and activities.

- 1 1/8" High Pressure Laminate (HPL) Top with Round Corner PVC Edge
- 2" Round Tube with 1 7/8" Round Insert, adjustable height 22"-30"
- 100% Polyester Premium Powder Coat Finish
- Standard Glides: Adjustable
- Optional Glides: Stainless Steel
- Options: 3" Casters, ADA Height (26"-34"), Standing Height (34"-42")

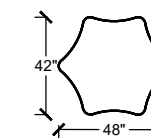

Model	Top Size	Wt. (lbs)	Freight Class
TN-INSP-48SPUR	48" DIA	83	KD 70



D-Shape

The Alumni Inspire D-Shape Table is designed for guided reading and collaboration. These tables offer strength and stability for a wide variety of learning environments and activities.

- 1 1/8" High Pressure Laminate (HPL) Top with Round Corner PVC Edge
- 2" Round Tube with 1 7/8" Round Insert, adjustable height 22"-30"
- 100% Polyester Premium Powder Coat Finish
- Standard Glides: Adjustable
- Optional Glides: Stainless Steel
- Options: 3" Casters, ADA Height (26"-34"), Standing Height (34"-42")



Model	Top Size	Wt. (lbs)	Freight Class
TN-INSP-4460DSHAPE	44"x60"	84	KD 70
TN-INSP-4472DSHAPE	44"x72"	86	KD 70
TN-INSP-4872DSHAPE	48"x72"	88	KD 70

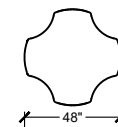
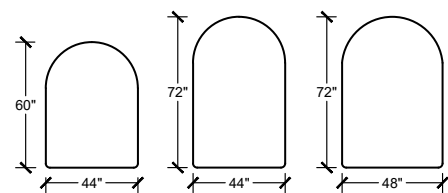

Clover

The Alumni Inspire Clover Table is designed for guided reading and collaboration. These tables offer strength and stability for a wide variety of learning environments and activities.

- 1 1/8" High Pressure Laminate (HPL) Top with Round Corner PVC Edge
- 2" Round Tube with 1 7/8" Round Insert, adjustable height 22"-30"
- 100% Polyester Premium Powder Coat Finish
- Standard Glides: Adjustable
- Optional Glides: Stainless Steel
- Options: 3" Casters, ADA Height (26"-34"), Standing Height (34"-42")

Model	Top Size	Wt. (lbs)	Freight Class
TN-INSP-48CL	48" DIA	46	KD 70

Flower

The Alumni Inspire Flower Table is designed for guided reading and collaboration. These tables offer strength and stability for a wide variety of learning environments and activities.

- 1 1/8" High Pressure Laminate (HPL) Top with Round Corner PVC Edge
- 2" Round Tube with 1 7/8" Round Insert, adjustable height 22"-30"
- 100% Polyester Premium Powder Coat Finish
- Standard Glides: Adjustable
- Optional Glides: Stainless Steel
- Options: 3" Casters, ADA Height (26"-34"), Standing Height (34"-42")

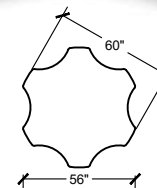

Model	Top Size	Wt. (lbs)	Freight Class
TN-INSP-60FL	60" DIA	73	KD 70



Traditional Rectangle

Traditional

The Alumni Inspire Traditional Tables offer strength and stability for a wide variety of learning environments and activities.

- 1 1/8" High Pressure Laminate (HPL) Top with Round Corner PVC Edge
- 2" Round Tube with 1 7/8" Round Insert, adjustable height 22"-30"
- 100% Polyester Premium Powder Coat Finish
- Standard Glides: Adjustable
- Optional Glides: Stainless Steel
- Options: 3" Casters, ADA Height (26"-34"), Standing Height (34"-42")



Traditional Round



Traditional Trapezoid

Model	Top Size	Wt. (lbs)	Freight Class
TN-INSP-1824*	18"x24"	30	KD 70
TN-INSP-2026*	20"x26"	30	KD 70
TN-INSP-2424*	24"x24"	34	KD 70
TN-INSP-2430*	24"x30"	34	KD 70
TN-INSP-2436	24"x36"	37	KD 70
TN-INSP-2448	24"x48"	44	KD 70
TN-INSP-2460	24"x60"	53	KD 70
TN-INSP-2472	24"x72"	67	KD 70
TN-INSP-3030	30"x30"	38	KD 70
TN-INSP-3036	30"x36"	40	KD 70
TN-INSP-3048	30"x48"	43	KD 70
TN-INSP-3060	30"x60"	62	KD 70
TN-INSP-3072	30"x72"	69	KD 70
TN-INSP-3636	36"x36"	42	KD 70
TN-INSP-3660	36"x60"	64	KD 70
TN-INSP-3672	36"x72"	79	KD 70
TN-INSP-4242	42"x42"	54	KD 70
TN-INSP-4848	48"x48"	64	KD 70
TN-INSP-36R	36" DIA	40	KD 70
TN-INSP-42R	42" DIA	52	KD 70
TN-INSP-48R	48" DIA	61	KD 70
TN-INSP-60R	60" DIA	90	KD 70
TN-INSP-24242448	24"x24"x24"x48"	32	KD 70
TN-INSP-30303060	30"x30"x30"x60"	37	KD 70



Guided Reading Kidney

Guided Reading

The Alumni Inspire Guided Reading Tables are designed for guided reading and collaboration. These tables offer strength and stability for a wide variety of learning environments and activities.

- 1 1/8" High Pressure Laminate (HPL) Top with Round Corner PVC Edge
- 2" Round Tube with 1 7/8" Round Insert, adjustable height 22"-30"
- 100% Polyester Premium Powder Coat Finish
- Standard Glides: Adjustable
- Optional Glides: Stainless Steel
- Options: 3" Casters, ADA Height (26"-34"), Standing Height (34"-42")



Guided Reading C-Shape



Guided Reading Horseshoe

Model	Top Size	Wt. (lbs)	Freight Class
TN-INSP-3672KDNY	36"x72"	76	KD 70
TN-INSP-4872-KDNY	48"x72"	80	KD 70
TN-INSP-3660CSHAPE	36"x60"	75	KD 70
TN-INSP-3672CSHAPE	36"x72"	83	KD 70
TN-INSP-4872C-SHAPE	48"x72"	87	KD 70
TN-INSP-6066HS	60"x66"	92	KD 70

*See pages 131 and 132 for Top Size Diagrams

Shaped Inspire Material Selector

Laminate Top

- | | | | | | | |
|---------------|-----------------|------------------|-----------------|-------------------|------------------|---------------|
| • Dark Walnut | • Bannister Oak | • Sugar Maple | • High Rise | • Agave Blue | • Primary Yellow | • Primary Red |
| • Mahogany | • Loft Oak | • Cosmic Strandz | • Vapor Strandz | • Eggplant Purple | • Primary Green | |
| • Wild Cherry | • New Age Oak | • Gray Spectrum | • Sprout Green | • Pomegranate Red | • Primary Blue | |

PVC Edge

- | | | | |
|-------------|------------------|-----------------|---------------|
| • Black | • Maple | • Primary Green | • Sky Blue |
| • Charcoal | • Beige | • Apple Green | • Plum |
| • Warm Gray | • Pumpkin | • Navy Blue | • Crimson |
| • Gray | • Primary Yellow | • Primary Blue | • Primary Red |

Leg

- Metallic



Tables T-Leg / Y-Leg



Integrity Double T-Leg



Integrity Single Leg Half-Round



Honor Roll Y-Leg

Integrity Double T-Leg



Shown with "T" Style Legs

The *Alumni Integrity Double T-Leg Table* is a contemporary table solution for public and private schools. Elliptical legs offer a modern and durable alternative to traditional activity tables.

- 3/4" or 1 1/8" High Pressure Laminate (HPL) Top with Round Corner PVC Edge
- All welded frame and legs consist of two 2"x1 1/4" 13-gauge upright oval steel tubes, adjustable height 22"-30"
- 100% Polyester Premium Powder Coat Finish
- Standard Glides: Floor-Friendly
- Optional Glides: Stainless Steel
- Options: Bag Hook, Fixed Height, ADA Height (26"-34"), Chrome Upper Frame, "C" or "T" Style Legs

Model	Top Size	Wt. (lbs)	Freight Class
T-INT-2048-DL	20"x48"	62	150
T-INT-2060-DL	20"x60"	66	150
T-INT-2424-DL	24"x24"	47	150
T-INT-2430-DL	24"x30"	50	150
T-INT-2448-DL	24"x48"	64	150
T-INT-2460-DL	24"x60"	68	150
T-INT-2472-DL	24"x72"	74	150
T-INT-3048-DL	30"x48"	63	150
T-INT-3060-DL	30"x60"	82	150
T-INT-3072-DL	30"x72"	89	150

Integrity Single Leg Half-Round



The *Alumni Integrity Single Leg Half-Round Table* is a contemporary table solution for public and private schools. Elliptical legs offer a modern and durable alternative to traditional activity tables.

- 3/4" or 1 1/8" High Pressure Laminate (HPL) Top with Round Corner PVC Edge
- All welded frame and legs consist of two 2"x1 1/4" upright oval steel tubes, adjustable height 22"-30"
- 100% Polyester Premium Powder Coat Finish
- ABS Scuff Guard
- Optional Glides: Adjustable or Stainless Steel
- Options: Bag Hook, Fixed Height, ADA Height (26"-34")

Model	Top Size	Wt. (lbs)	Freight Class
T-INT-3060HR	30"x60"	80	150



Shown with Bag Hook

Honor Roll Y-Leg

The *Alumni Honor Roll Y-Leg Table* has a full frame to take the wiggle out of learning. Y-Leg design offers extra space below the table.

- 3/4" or 1 1/8" High Pressure Laminate (HPL) Top with Round Corner PVC Edge
- 1 1/2" Square Tube, Lower T-Chrome Insert, adjustable height 22"-30"
- 100% Polyester Premium Powder Coat Finish
- Standard Glides: Adjustable
- Optional Glides: Stainless Steel
- Options: Bag Hook, Fixed Height, 3" Casters

Model	Top Size	Wt. (lbs)	Freight Class
TY-2026	20"x26"	47	150
TY-2430	24"x30"	50	150
TY-2448	24"x48"	64	150
TY-2460	24"x60"	68	150

T-Leg Activity Material Selector

Laminate Top

- Dark Walnut
- Bannister Oak
- Sugar Maple
- High Rise
- Agave Blue
- Primary Yellow
- Primary Red
- Mahogany
- Loft Oak
- Cosmic Strandz
- Vapor Strandz
- Eggplant Purple
- Primary Green
- Wild Cherry
- New Age Oak
- Gray Spectrum
- Sprout Green
- Pomegranate Red
- Primary Blue

PVC Edge

- Black
- Maple
- Primary Green
- Sky Blue
- Charcoal
- Beige
- Apple Green
- Plum
- Warm Gray
- Pumpkin
- Navy Blue
- Crimson
- Gray
- Primary Yellow
- Primary Blue
- Primary Red

Frame

- Black
- Gray
- Navy Blue
- Hammertone Black
- Metallic
- Burgundy
- Hammertone Gray
- Beige
- Dark Gray
- Hunter Green



Tables Computer



Integrity
Double Leg



Integrity Flip



Honor Roll T-Leg



Honor Roll Y-Leg



Honor Roll
4-Leg Flip



Honor Roll 4-Leg



Flex Connect
Technology



Flex Connect
Single Leg



Flex Connect
Double Leg



Shown with "T" Style Legs

Integrity Double Leg

The Alumni Integrity Double Leg Computer Table offers strength and stability for computer labs and libraries. Cord trough attached for wire management. Elliptical legs offer a modern and durable alternative to traditional computer tables.

- 3/4" or 1 1/8" High Pressure Laminate (HPL) Top with Round Corner PVC Edge
- Four 2"x1 1/4" Upright Oval Steel Tubes Welded to Four 2"x1 1/4" Steel Oval Tubes 2"x1 1/4" Cross Tube Welded to Midsection of Leg Assembly, "C" or "T" Style Leg, adjustable height 22"-30"
- 100% Polyester Premium Powder Coat Finish
- Standard Glides: Floor-Friendly
- Optional Glides: Stainless Steel
- Options: Fixed Height, Bag Hook, Keyboard Tray, Power Bar, Grommet(s), 3" Casters

Model	Top Size	Wt. (lbs)	Freight Class
CT-INT-DL-2436	24"x36"	47	250
CT-INT-DL-2448	24"x48"	57	250
CT-INT-DL-2460	24"x60"	65	250
CT-INT-DL-2472	24"x72"	70	250
CT-INT-DL-3036	30"x36"	53	250
CT-INT-DL-3048	30"x48"	63	250
CT-INT-DL-3060	30"x60"	70	250
CT-INT-DL-3072	30"x72"	77	250
CT-INT-DL-3660	36"x60"	75	250
CT-INT-DL-3672	36"x72"	82	250



Shown with "C" Style Legs

Integrity Flip

The Alumni Integrity Flip Computer Table offers strength and stability for computer labs and libraries. Flip-up cord trough makes it easy and convenient to access and hide cords, wires and power accessories. Elliptical legs offer a modern and durable alternative to traditional computer tables.

- 3/4" or 1 1/8" High Pressure Laminate (HPL) Top with Round Corner PVC Edge
- Four 2"x1 1/4" Upright Oval Steel Tubes Welded to Four 2"x1 1/4" Steel Oval Tubes 2"x1 1/4" Cross Tube Welded to Midsection of Leg Assembly, "C" or "T" Style Legs, adjustable height 22"-30"
- 100% Polyester Premium Powder Coat Finish
- Standard Glides: Floor-Friendly
- Optional Glides: Stainless Steel
- Options: Fixed Height, Quarter Turn Lock, Bag Hook, Power Bar, Keyboard Tray, 3" Casters

Model	Top Size	Wt. (lbs)	Freight Class
CT-INT-FLIP-3036-DL	30"x36"	65	250
CT-INT-FLIP-3048-DL	30"x48"	76	250
CT-INT-FLIP-3060-DL	30"x60"	84	250
CT-INT-FLIP-3072-DL	30"x72"	91	250



Honor Roll T-Leg

The Alumni Honor Roll Full Frame Computer Table takes the wiggle out of your learning experience. These tables offer strength and stability for computer labs and libraries. Modesty panel and wire management all-in-one. T-leg design offers extra space below the table and allows for ease of entry.

- Standard Plastic Laminate Top with Round Corner PVC Edge
- 1 1/2" Square Tube, 16-Gauge Frame with Cord Trough, adjustable height 22"-30"
- 100% Polyester Premium Powder Coat Finish
- Standard Glides: Adjustable
- Optional Glides: Stainless Steel
- Options: Bag Hook, Fixed Height, CPU Holder, Keyboard Tray, Power Bar, Grommet(s), 3" Casters, 3/4" or 1 1/8" High Pressure Laminate (HPL) Top with Round Corner PVC Edge

Model	Top Size	Wt. (lbs)	Freight Class
CTT-2448	24"x48"	51	KD 70
CTT-2460	24"x60"	62	KD 70
CTT-2472	24"x72"	68	KD 70
CTT-3036	30"x36"	46	KD 70
CTT-3048	30"x48"	55	KD 70
CTT-3060	30"x60"	66	KD 70
CTT-3072	30"x72"	73	KD 70



Honor Roll Y-Leg

The Alumni Honor Roll Y-Leg Computer Table takes the wiggle out of your learning experience. These tables offer strength and stability for computer labs and libraries. Modesty panel and wire management all-in-one with Y-leg design offers extra space below the table and allows for ease of entry.

- 3/4" or 1 1/8" High Pressure Laminate (HPL) Top with Round Corner PVC Edge
- 1 1/2" Square Tube Upper Frame with Cord Trough, 1 1/8" Square Tube Insert, adjustable height 22"-30"
- 100% Polyester Premium Powder Coat Finish
- Standard Glides: Adjustable
- Optional Glides: Stainless Steel
- Options: Bag Hook, Fixed Height, Keyboard Tray, Power Bar, Grommet(s), 3" Casters

Model	Top Size	Wt. (lbs)	Freight Class
CTY-2448	24"x48"	51	KD 70
CTY-2460	24"x60"	62	KD 70
CTY-2472	24"x72"	68	KD 70
CTY-3036	30"x36"	46	KD 70
CTY-3048	30"x48"	55	KD 70
CTY-3060	30"x60"	66	KD 70
CTY-3072	30"x72"	73	KD 70



Honor Roll 4-Leg Flip

The Alumni Honor Roll 4-Leg Flip Computer Table takes the wiggle out of your learning experience. These tables offer strength and stability for computer labs and libraries. Flip-up cord trough makes it easy and convenient to access and hide cords, wires and power accessories.

- Standard Plastic Laminate Top with Round Corner PVC Edge
- 2" Channel Welded Apron, 1 1/4" Square Tube with 1 1/8" Square Tube Insert, 16-Gauge, Adjustable Height 22"-30"
- 100% Polyester Premium Powder Coat Finish
- Standard Glides: Adjustable
- Optional Glides: Stainless Steel
- Options: Bag Hook, Fixed Height, Power Bar, Key Board Tray, 3" Caster, 3/4" or 1 1/8" High Pressure Laminate (HPL) Top with Round Corner PVC Edge, Quarter Turn Lock

Model	Top Size	Wt. (lbs)	Freight Class
CT-FLIP-3036	30"x36"	55	KD 70
CT-FLIP-3048	30"x48"	63	KD 70
CT-FLIP-3060	30"x60"	74	KD 70
CT-FLIP-3072	30"x72"	81	KD 70



Honor Roll 4-Leg

The Alumni Honor Roll 4-Leg Computer Table offers strength and stability for a wide variety of learning environments and activities.

- Standard Plastic Laminate Top with Round Corner PVC Edge
- 2" Channel Welded Apron, 1 1/4" Square Tube with 1 1/8" Square Tube Insert, 16-Gauge, adjustable height 22"-30"
- 100% Polyester Premium Powder Coat Finish
- Standard Glides: Adjustable
- Optional Glides: Stainless Steel
- Options: Bag Hook, Fixed Height, Power Bar, Key Board Tray, 3" Caster, 3/4" or 1 1/8" High Pressure Laminate (HPL) Top with Round Corner PVC Edge, Grommet(s)

Model	Top Size	Wt. (lbs)	Freight Class
CT-2436	24"x36"	41	KD 70
CT-2448	24"x48"	55	KD 70
CT-2460	24"x60"	69	KD 70
CT-2472	24"x72"	75	KD 70
CT-3036	30"x36"	40	KD 70
CT-3048	30"x48"	60	KD 70
CT-3060	30"x60"	72	KD 70
CT-3072	30"x72"	78	KD 70
CT-3096	30"x96"	115	KD 70
CT-3660	36"x60"	78	KD 70
CT-3672	36"x72"	102	KD 70



Flex Connect Technology

The Alumni Flex Connect Table is a full tech table solution. Contoured cord trough with access door to enclose the Flex. Optional connect power solutions available. Contains a separate data cord channel. Contoured shaped double leg design.

- 1 1/8" High Pressure Laminate (HPL) Top with Round Corner PVC Edge
- 1 1/2" x 1 1/2" 16-Gauge Contour-Shaped Leg Design, fixed height 27" or 29"
- 100% Polyester Premium Powder Coat Finish
- Standard Glides: Adjustable
- Optional Glides: Stainless Steel
- Multiple Power Options Available (please contact your ESM for the full offering)
- Options: Bag Hook, Ganging, Keyboard Tray, Grommet(s), Quarter Turn Lock, 3" Casters

Model	Top Size	Wt. (lbs)	Freight Class
FCT-2436-FX	24"x36"	54	250
FCT-2448-FX	24"x48"	57	250
FCT-2460-FX	24"x60"	65	250
FCT-2472-FX	24"x72"	70	250
FCT-3036-FX	30"x36"	55	250
FCT-3048-FX	30"x48"	58	250
FCT-3060-FX	30"x60"	78	250
FCT-3072-FX	30"x72"	84	250

Computer Material Selector

Laminate Top

- Dark Walnut
- Bannister Oak
- Sugar Maple
- High Rise
- Agave Blue
- Primary Yellow
- Primary Red
- Mahogany
- Loft Oak
- Cosmic Strandz
- Vapor Strandz
- Eggplant Purple
- Primary Green
- Wild Cherry
- New Age Oak
- Gray Spectrum
- Sprout Green
- Pomegranate Red
- Primary Blue

PVC Edge

- Black
- Maple
- Primary Green
- Sky Blue
- Charcoal
- Beige
- Apple Green
- Plum
- Warm Gray
- Pumpkin
- Navy Blue
- Crimson
- Gray
- Primary Yellow
- Primary Blue
- Primary Red

Frame

- Black
- Gray
- Navy Blue
- Hammertone Black
- Metallic
- Burgundy
- Hammertone Gray
- Beige
- Dark Gray
- Hunter Green





Flex Connect Single Leg

The Alumni Flex Connect Single Leg Desk is a sophisticated student desk with a modesty panel. Cantilever style desk with contoured leg design.

- 1 1/8" High Pressure Laminate (HPL) Top with Round Corner PVC Edge or Hard Plastic (HP) in limited sizes(*)
- 1 1/2"x1 1/2" 16-Gauge Contour-Shaped Leg Design with Perforated Modesty Panel, fixed height 27"-29"
- 100% Polyester Premium Powder Coat Finish
- Standard Glides: Adjustable
- Optional Glides: Stainless Steel
- Options: Bag Hook, Ganging

Model	Top Size	Wt. (lbs)	Freight Class
FCS-1824-FX *	18"x24"	30	250
FCS-2424-FX *	24"x24"	32	250
FCS-2430-FX *	24"x30"	37	250
FCS-2436-FX	24"x36"	42	250
FCS-2448-FX	24"x48"	45	250
FCS-2460-FX	24"x60"	53	250
FCS-2472-FX	24"x72"	58	250



Flex Connect Double Leg

The Alumni Flex Connect Double Leg Desk is a sophisticated student desk with a modesty panel. Cantilever style desk with contoured double leg design.

- 1 1/8" High Pressure Laminate (HPL) Top with Round Corner PVC Edge or Hard Plastic (HP) in limited sizes(*)
- 1 1/2"x1 1/2" 16-Gauge Contour-Shaped Double Leg Design with Perforated Modesty Panel, fixed height 27"-29"
- 100% Polyester Premium Powder Coat Finish
- Standard Glides: Adjustable
- Optional Glides: Stainless Steel
- Options: Bag Hook, Ganging

Model	Top Size	Wt. (lbs)	Freight Class
FCD-2424-FX *	24"x24"	42	250
FCD-2430-FX*	24"x30"	47	250
FCD-2436-FX	24"x36"	52	250
FCD-2448-FX	24"x48"	55	250
FCD-2460-FX	24"x60"	63	250
FCD-2472-FX	24"x72"	68	250
FCD-3036-FX	30"x36"	53	250
FCD-3048-FX	30"x48"	56	250
FCD-3060-FX	30"x60"	76	250
FCD-3072-FX	30"x72"	82	250

Flex Connect Single Student Material Selector

Hard Plastic Top

- Dark Walnut, Mahogany, Wild Cherry, Bannister Oak, Loft Oak, Golden Oak, New Age Oak, Sugar Maple, Beige Sand, Cosmic Strandz, Gray Spectrum, Gray Sand, High Rise, Vapor Strandz, Sprout Green, Agave Blue, Eggplant Purple, Pomegranate Red

Laminate Top

- Dark Walnut, Mahogany, Wild Cherry, Bannister Oak, Loft Oak, New Age Oak, Sugar Maple, Cosmic Strandz, Gray Spectrum, High Rise, Vapor Strandz, Sprout Green, Agave Blue, Eggplant Purple, Pomegranate Red, Primary Yellow, Primary Green, Primary Blue, Primary Red

PVC Edge

- Black, Charcoal, Warm Gray, Gray, Maple, Beige, Pumpkin, Primary Green, Apple Green, Navy Blue, Primary Blue, Sky Blue, Plum, Crimson, Primary Red

Frame

- Black, Hammertone Black, Hammertone Gray, Dark Gray, Gray, Metallic, Beige, Hunter Green, Navy Blue, Burgundy



Makerspace Works



Makerspace Works
HPL Table

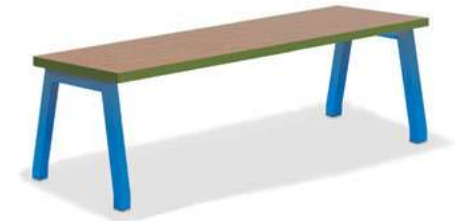

Makerspace Works
HPL Bench



Makerspace Works
Block Table



Makerspace Works
Block Bench



Makerspace Works
Epoxy Table



Makerspace Works HPL Table

The Alumni Makerspace Works HPL Table offers a variety of uses for both students and teachers. The multiple combinations that are offered have been created to meet the needs of a 21st Century classroom.

- 1 1/8" High Pressure Laminate (HPL) Top with Round Corner PVC Edge
- Fully welded mounting plate with cord trough attached to four 2"x2" steel legs, fixed height
- 100% Premium Powder Coat Finish
- Standard Casters: 4" Locking Caster
- Optional Glides: Fixed
- Options: Grommet, Fixed Height (30", 36", or 42"), Shelf, Footrests

Model	Top Size	Wt. (lbs)	Freight Class
MSWT-HPL-3048	30"x48"	106	70
MSWT-HPL-3060	30"x60"	121	70
MSWT-HPL-3072	30"x72"	137	70
MSWT-HPL-3648	36"x48"	112	70
MSWT-HPL-3660	36"x60"	127	70
MSWT-HPL-3672	36"x72"	143	70
MSWT-HPL-4248	42"x48"	120	70
MSWT-HPL-4260	42"x60"	138	70
MSWT-HPL-4272	42"x72"	156	70
MSWT-HPL-4848	48"x48"	143	70
MSWT-HPL-4860	48"x60"	165	70
MSWT-HPL-4872	48"x72"	188	70

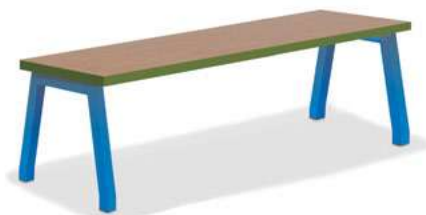

Makerspace Works HPL Bench

The Alumni Makerspace Works HPL Bench is complimentary to the Makerspace Works Table as it allows for both collaborative and individual learning opportunities that meet the needs of a 21st Century classroom.

- 1 1/8" High Pressure Laminate (HPL) Top with Square Corner PVC Edge
- Fully welded mounting plate attached to four 2"x2" steel legs, fixed height 18"
- 100% Premium Powder Coat Finish
- Standard Glides: Fixed

Model	Top Size	Wt. (lbs)	Freight Class
MSWB-HPL-1246-FX18	12"x46"	50	70
MSWB-HPL-1258-FX18	12"x58"	59	70
MSWB-HPL-2446-FX18	24"x46"	83	70
MSWB-HPL-2458-FX18	24"x58"	101	70



Makerspace Works Block Table

The Alumni Makerspace Works Block Table offers a variety of uses for both students and teachers. The multiple combinations that are offered have been created to meet the needs of a 21st Century classroom.

- 1 3/4" Butcher Block Top
- Fully welded mounting plate with cord trough attached to four 2"x2" steel legs, fixed height
- 100% Premium Powder Coat Finish
- Standard Casters: 4" Locking Caster
- Optional Glides: Fixed
- Options: Fixed Height (30", 36", or 42"), Shelf, Footrests

Model	Top Size	Wt. (lbs)	Freight Class
MSWT-BLK-3060	30"x60"	124	70
MSWT-BLK-3072	30"x72"	135	70
MSWT-BLK-3660	36"x60"	145	70
MSWT-BLK-3672	36"x72"	174	70
MSWT-BLK-4848	48"x48"	143	70



Makerspace Works Block Bench

The Alumni Makerspace Works Block Bench is complimentary to the Makerspace Works Table as it allows for both collaborative and individual learning opportunities that meet the needs of a 21st Century classroom.

- 1 3/4" Butcher Block Top
- Fully welded mounting plate attached to four 2"x2" steel legs, fixed height 18"
- 100% Premium Powder Coat Finish
- Standard Glides: Fixed

Model	Top Size	Wt. (lbs)	Freight Class
MSWB-BLK-1246-FX18	12"x46"	55	70
MSWB-BLK-1258-FX18	12"x58"	66	70
MSWB-BLK-2446-FX18	24"x46"	93	70
MSWB-BLK-2458-FX18	24"x58"	115	70



Front View



Makerspace Work Epoxy Table

The Alumni Makerspace Works Epoxy Table offers a variety of uses for both students and teachers. The multiple combinations that are offered have been created to meet the needs of a 21st Century classroom.

- Black Epoxy Resin Top
- Fully welded mounting plate with cord trough attached to four 2"x2" steel legs, fixed height
- 100% Premium Powder Coat Finish
- Standard Casters: 4" Locking Casters
- Optional Glides: Fixed
- Options: Fixed Height (30", 36", or 42"), Shelf, Footrests



Shown with optional Footrests



Shown with optional Shelf

Model	Top Size	Wt. (lbs)	Freight Class
MSWT-EPX-3660	36"x60"	227	70

Makerspace Works Material Selector

Laminate Top

- | | | | | | | |
|---------------|-----------------|------------------|-----------------|-------------------|------------------|---------------|
| ● Dark Walnut | ● Bannister Oak | ● Sugar Maple | ● High Rise | ● Agave Blue | ● Primary Yellow | ● Primary Red |
| ● Mahogany | ● Loft Oak | ● Cosmic Strandz | ● Vapor Strandz | ● Eggplant Purple | ● Primary Green | |
| ● Wild Cherry | ● New Age Oak | ● Gray Spectrum | ● Sprout Green | ● Pomegranate Red | ● Primary Blue | |

PVC Edge

- | | | | |
|-------------|------------------|-----------------|---------------|
| ● Black | ● Maple | ● Primary Green | ● Sky Blue |
| ● Charcoal | ● Beige | ● Apple Green | ● Plum |
| ● Warm Gray | ● Pumpkin | ● Navy Blue | ● Crimson |
| ● Gray | ● Primary Yellow | ● Primary Blue | ● Primary Red |

Frame

- | | | | |
|--------------------|----------------|-------------|---------------|
| ● Black | ● Gray | ● Navy Blue | ● Apple Green |
| ● Hammertone Black | ● Metallic | ● Burgundy | ● Ocean Blue |
| ● Hammertone Gray | ● Beige | ● Pumpkin | |
| ● Dark Gray | ● Hunter Green | ● Plum | |

- | | |
|---------------------|-----------------|
| ● Black Epoxy Resin | ● Butcher Block |
|---------------------|-----------------|





Convertible Bench

The Alumni Convertible Bench Table is a safe and flexible solution for cafeterias and auditoriums. They easily convert from a cafeteria table to an auditorium bench in one easy motion, and folds and nests for convenient storage. Includes High Pressure Laminate with Armor Edge that eliminates seams which can accumulate dirt, bacteria and moisture.

- 3/4" or 1 1/8" High Pressure Laminate (HPL) Top with Armor Edge
- Two 2"x1 1/4", Base Tube is 2"x1 1/4" Oval Tubes, Remaining Framing Components are Fully Welded 1 1/4" O.D.
- 100% Polyester Premium Hammertone Powder Coat Finish
- Standard Glides: 4" Heavy Duty Casters and Boot Glides

Tables Latch Together Securely for Picnic Table-Style Seating



Folds and Nests for Convenient Storage



Bench-Style Seating



Model	Top Size	Seat Size	Wt. (lbs)	Freight Class
CBT-96-29	15"x96"	12"x96"	131	125

Convertible Bench Material Selector

Laminate Top

- | | | | | | | |
|-------------|---------------|----------------|---------------|-----------------|----------------|-------------|
| Dark Walnut | Bannister Oak | Sugar Maple | High Rise | Agave Blue | Primary Yellow | Primary Red |
| Mahogany | Loft Oak | Cosmic Strandz | Vapor Strandz | Eggplant Purple | Primary Green | |
| Wild Cherry | New Age Oak | Gray Spectrum | Sprout Green | Pomegranate Red | Primary Blue | |

Armor Edge

- Black
- Gray
- Beige

Frame

- Hammertone Black
- Hammertone Gray



Pedestal

The Alumni Cafe Height Pedestal Table has a contemporary and versatile design, that is practical for the cafeteria or learning commons.

- 1 1/8" High Pressure Laminate (HPL) Top with round PVC Edge
- One 2 1/4" Tubular Column with Fabricated Steel Mounting Plate and Cast Aluminum Base, fixed height
- 100% Polyester Premium Silver Powder Coat Finish, Comparable to Alumni's Metallic
- Standard Glides: Adjustable
- Options: Fixed Height 30", 36" or 42"

Model	Top Size	Wt. (lbs)	Freight Class
T-36R-CAFE	36" DIA	55	250
T-42R-CAFE	42" DIA	60	250
T-3636SQ-CAFE	36"x36"	59	250
T-4242SQ-CAFE	42"x42"	65	250



Shown with Alumni Air Cafe 4-leg Chairs

Pedestal Material Selector

Laminate Top

- | | | | | | | |
|-------------|---------------|----------------|---------------|-----------------|----------------|-------------|
| Dark Walnut | Bannister Oak | Sugar Maple | High Rise | Agave Blue | Primary Yellow | Primary Red |
| Mahogany | Loft Oak | Cosmic Strandz | Vapor Strandz | Eggplant Purple | Primary Green | |
| Wild Cherry | New Age Oak | Gray Spectrum | Sprout Green | Pomegranate Red | Primary Blue | |

PVC Edge

- | | | | |
|-----------|----------------|---------------|-------------|
| Black | Maple | Primary Green | Sky Blue |
| Charcoal | Beige | Apple Green | Plum |
| Warm Gray | Pumpkin | Navy Blue | Crimson |
| Gray | Primary Yellow | Primary Blue | Primary Red |

Frame

- Silver





T-FLIP-CLOUD Flipped

Nesting Flip

The Alumni Nesting Flip Table is contemporary, versatile and practical for use in many learning environments and other applications. Cable pull flip-flop mechanism makes flip-up and flip-down a breeze. These tables are mobile with 2" Twin Wheel Locking Casters. Tables easily flip up and nest for convenient storage.

- 1 1/8" High Pressure Laminate (HPL) Top with Round Corner PVC Edge
- 2 1/4" Diameter Steel and Aluminum Tubing, 20" Wide Leg Base, fixed height 29"
- 100% Polyester Premium Metallic Powder Coat Finish
- Standard Casters: 2" Twin Wheel Locking Casters
- Optional Glides: Fixed



T-FLIP-CLOUD Upright

Nesting Flip Material Selector

Laminate Top

- Dark Walnut
- Bannister Oak
- Sugar Maple
- High Rise
- Agave Blue
- Primary Yellow
- Primary Red
- Mahogany
- Loft Oak
- Cosmic Strandz
- Vapor Strandz
- Eggplant Purple
- Primary Green
- Wild Cherry
- New Age Oak
- Gray Spectrum
- Sprout Green
- Pomegranate Red
- Primary Blue

PVC Edge

- Black
- Maple
- Primary Green
- Sky Blue
- Charcoal
- Beige
- Apple Green
- Plum
- Warm Gray
- Pumpkin
- Navy Blue
- Crimson
- Gray
- Primary Yellow
- Primary Blue
- Primary Red

Frame

- Metallic



T-FLIP-2460 Upright

T-FLIP-2460 Flipped

Model	Top Size	Wt. (lbs)	Freight Class
T-FLIP-2448	24"x48"	62	KD 70
T-FLIP-2460	24"x60"	70	KD 70
T-FLIP-2472	24"x72"	78	KD 70
T-FLIP-OGEEBR	30"x54"	65	KD 70
T-FLIP-CLOUD	39"x69"	64	KD 70
T-FLIP-PUZZLE	40"x56"	68	KD 70
T-FLIP-ZEPHYR	41"x72"	82	KD 70
T-FLIP-SIXSIGMA	48"x70"	82	KD 70

*See page 198 for Top Size Diagrams of the Ogee Breeze, Cloud, Puzzle, Zephyr, and Six-Sigma



Shown at 36" Height

Science Table Standard

The Alumni Science Table Standard features a full frame construction. The acid resistant laminate top is well suited to any science lab or art classroom.

- Acid Resistant Laminate Top with Round Corner PVC Edge
- 2" Channel Welded Apron, 1 1/8" Square Upper Tube with Chrome Insert, adjustable height 22"-30"
- 100% Premium Powder Coat Finish
- Standard Glides: Adjustable
- Optional Glides: Stainless Steel
- Options: Bag Hook(s), Epoxy Resin Top, 3" Casters, or 4" Casters, Fixed Height, ADA Height (26"-34"), Standing Height (34"-42")

Model	Top Size	Wt. (lbs)	Wt. (lbs)*	Freight Class
T-SCIE-2448	24"x48"	66	N/A	KD 70
T-SCIE-2454	24"x54"	70	174	KD 70
T-SCIE-2460	24"x60"	74	178	KD 70
T-SCIE-3048	30"x48"	59	163	KD 70
T-SCIE-3060	30"x60"	87	217	KD 70
T-SCIE-3072	30"x72"	92	248	KD 70

*Table Weight with Optional Epoxy Resin Top

Science Table Mobile

The Alumni Science Table Mobile offers the ability to reconfigure the classroom for different experiments and activities.

- Acid Resistant Laminate Top with Round Corner PVC Edge
- 3" Channel Welded Apron, 1 1/2" Square Upper Tube with Chrome Insert, Standard End Frame Brace, fixed height
- 100% Premium Powder Coat Finish
- Standard Glides: Adjustable Glide and Two Legs with 3" Locking Casters
- Optional Glides: Stainless Steel and Two Legs with 3" Locking Casters
- Options: Bag Hook, Epoxy Resin Top, 4" Casters, H-Frame Brace, Fixed Height (30", 36", or 42")

Model	Top Size	Wt. (lbs)	Wt. (lbs)*	Freight Class
T-SCIE-MOB-2448	24"x48"	93	N/A	250
T-SCIE-MOB-2460	24"x60"	107	211	250
T-SCIE-MOB-2472	24"x72"	132	288	250

*Table Weight with Optional Epoxy Resin Top

Science Table Material Selector

Top Option

- Black Acid Resistant (Standard)
- Black Epoxy Resin (Optional)

Frame

- Black



Folding Table



The Alumni Lite ABS Plastic Impact Resistant Folding Table is built to withstand up to 2,000 lbs. of equally distributed weight. Rigid core material with heavy gauge steel frame. Injection molded ABS corners are designed to absorb a 12-inch height drop without causing structural damage. Replaceable rubber stacking bumpers keep tables from sliding and protects the table surface when stacked.

- ABS Impact Resistant Plastic, Sonically Welded Top
- 100% Polyester Premium Black Powder Coat Finish
- 1" Round Tubing with Brackets Fastened Directly to the Top Providing Maximum Holding Power Allowing the Screws to Securely Stay in Place Without Stripping, fixed height 30"
- Skid Resistant Over Fitted Glide

Model	Top Size	Wt. (lbs)	Freight Class
AL-3060-ABS	30"x60"	41	100
AL-3072-ABS	30"x72"	48	100
AL-3096-ABS	30"x96"	53	100
AL-3672-ABS	36"x72"	58	100

Folding Table Material Selector

ABS Top

- Dark Gray

Frame

- Black



Folding Chair

The Alumni Folding Chair features a high strength polypropylene seat and back. Its contoured back and waterfall seat edge promote better posture and circulation. Stacks flat, making it great for storage.

- High Strength Polypropylene Seat and Back
- Standard Glides: Vinyl Insert
- 7/8" Round, 18-Gauge Steel Leg
- Option: Ganging
- 100% Polyester Premium Powder Coat Finish



Optional Fixed Ganging Feature

Model	Size	Wt. (lbs)	Freight Class
C-PF-18	Senior: 18"	7	KD 70

Folding Chair Material Selector

Frame, Seat & Back

- Black



Standard Dolly

The Alumni Standard Dolly is used to transport stacks of chairs by lifting underneath the glides of the chair. Best suited for Alumni 4-Leg and Cantilever chairs.

- Fully Welded Tubular Frame Made of Steel Welded to a Steel Plate Formed Platform
- 8" Heavy Duty Solid Wheels



Under Chair Scoop Dolly

The Alumni Under Chair Scoop Dolly is used to transport stacks of chairs by lifting underneath the seat of the chair. Recommended for use with Alumni 4-Leg and Cantilever chairs.

- Fully Welded Tubular Frame Made of Heavy Gauge Steel Welded to a U-Shaped Scoop Platform
- Standard Wheels: 8" Heavy Duty Solid Wheels



Square Platform Dolly

The Alumni Square Platform Dolly is used to transport stacks of chairs by placing them on top of the platform. This is to be utilized with the Alumni 4-Leg chairs.

- Fully Welded Tubular Frame Made of Heavy Gauge Steel
- Standard Wheels: 3" Heavy Duty Caster Wheels



CART-CHAIR-PF
Folding Chair Cart Holds Up to 50 Chairs

Folding Table and Chair Carts

The Alumni Folding Table and Chair Carts are fully-welded frame assembly made of angle steel and a wooden deck to allow tables to securely nest in a flat stacking position. Heavy duty push/pull handle.

- 4" Heavy Duty Swivel Casters

Dolly Material Selector

Frame

- Black



Accelerator Active Learning Centers

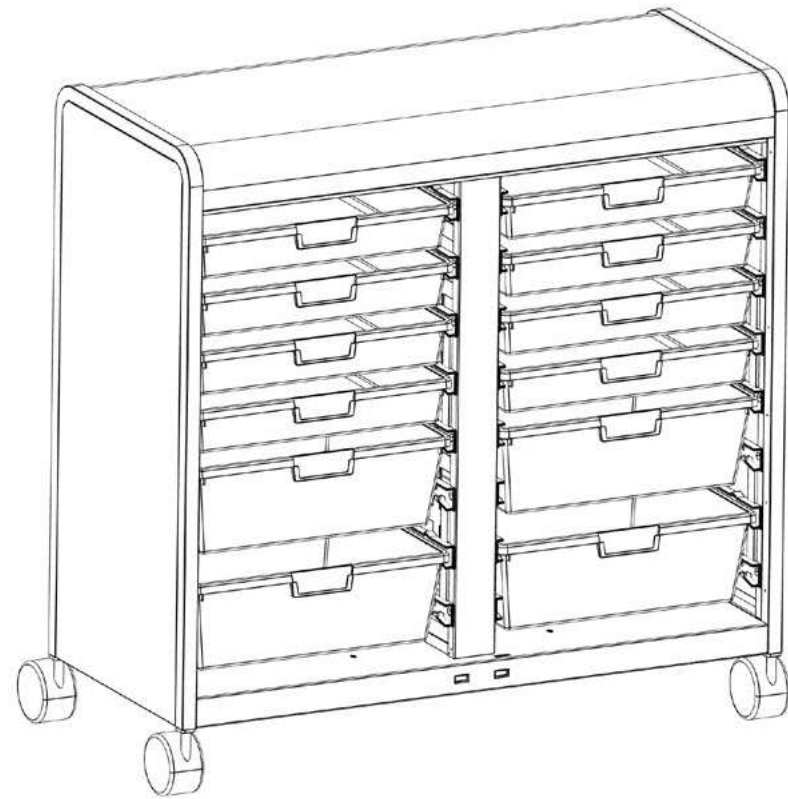

Our Accelerator line of products present teachers with the flexibility to utilize the whole classroom space without the restriction of built in storage.



Accelerator Active Learning Centers



Accelerator Storage with Shelves



Accelerator Storage with Totes



Accelerator Storage Jumbo-Width with Totes and Shelves



Accelerator Jumbo-Width Cubby



Accelerator Teacher Wardrobe



Accelerator AV Power Cart



Accelerator Sit Stand Teacher Desk Crescent



Accelerator Teacher Desk



Accelerator Storage with Shelves

The Alumni Accelerator Storage with Shelves provide an alternative storage solution to built-in units which enables teachers to configure their classrooms to meet the needs of their students. The shelves are adjustable allowing storage room for supplies and learning tools of varying sizes.

- Formed steel construction with the use of machine screw fasteners for the attachment of the panels
- Easy to Configure Adjustable Shelves
- 100% Polyester Premium Metallic Powder Coat Finish (For Shelves, Top, Back, and Base Panels)
- 100% Polyester Premium Powder Coat Finish (For Side Panels)
- Standard Casters: 4" Casters, 5" Casters (dependant on unit size)
- Optional Glides: Fixed
- Options: Doors with Secure Lock, Riser (Available for Specific Sizes and Heights), Lectern (Available for Specific Sizes and Heights), Laptop Tray (Only Available with Riser), Whiteboard Back Panel (Available on specific sizes and heights), Peg Board Sides
- Available Heights: Tall Height (61.4"), Medium Height (43.3"), and Lower Height (30.4")
- Available Widths: Jumbo-Width (43"), Intermediate-Width (29"), and Micro-Width (21")



Micro-Width / Lower Height Shown with optional Riser and Laptop Tray



Jumbo-Width / Height Shown with optional Riser



Jumbo-Width / Tall Height Shown with optional Doors



Micro-Width / Tall Height

Micro-Width / Medium Height



Jumbo-Width / Lower Height Shown with optional Doors

Model	Size	Wt. (lbs)	Freight Class
AALC-MW-LH-SH	19"x21"x30.4"	49	100
AALC-MW-MH-SH	19"x21"x43.3"	63	100
AALC-MW-TH-SH	19"x21"x61.4"	81	100
AALC-IW-LH-SH	19"x29"x30.4"	63	100
AALC-IW-MH-SH	19"x29"x43.3"	81	100
AALC-IW-TH-SH	19"x29"x61.4"	102	100
AALC-JW-LH-SH	19"x43"x30.4"	82	100
AALC-JW-MH-SH	19"x43"x43.3"	105	100
AALC-JW-TH-SH	19"x43"x61.4"	134	100



Jumbo-Width / Tall Height

Intermediate-Width / Medium Height

Micro-Width / Lower Height

Accelerator Storage with Totes

The Alumni Accelerator Storage with Totes provide an alternative solution to traditional student desk storage, which enables teachers to utilize their space more efficiently for incorporation of 21st Century teaching techniques. Totes are available in two widths: 18 1/2" (EW) and 12 1/4" (SW).

- Formed steel construction with the use of machine screw fasteners for the attachment of the panels
- Tote Sizes: 3", 6", and/or 12" Standard Width (SW) Totes, 3" and 6" Extra Width (EW) Totes (Size and Quantity Dependent on Height and Width Chosen)
- 100% Polyester Premium Metallic Powder Coat Finish (For Top, Back, and Base Panels)
- 100% Polyester Premium Powder Coat Finish (For Side Panels)
- Standard Casters: 4" Casters, 5" Casters (dependant on unit size)
- Optional Glides: Fixed
- Options: Doors with Secure Lock, Riser (Available for specific sizes and heights), Lectern (Available for specific sizes and heights), Laptop Tray (Only Available with Riser), Whiteboard Back Panel (Available on specific sizes and heights), Peg Board Sides
- Available Heights: Tall Height (61.4"), Medium Height (43.3"), and Lower Height (30.4")
- Available Widths: Jumbo-Width (43"), Intermediate-Width (29"), and Micro-Width (21")



Micro-Width / Lower Height Shown with optional Riser



Micro-Width / Tall Height Shown with optional Door



Micro-Width / Tall Height



Intermediate-Width / Lower Height



Intermediate-Width / Lower Height Shown with optional Riser



Intermediate-Width / Tall Height Shown



Jumbo-Width / Medium Tall Height Shown with optional Peg Board Sides



Jumbo-Width / Tall Height Shown with optional Peg Board Sides



Jumbo-Width / Medium Height Shown with optional Doors



Jumbo-Width / Lower Height Shown with optional Peg Board Sides

Model	Size	Wt. (lbs)	Freight Class
AALC-MW-LH-EW	19"x21"x30.4"	49	100
AALC-MW-MH-EW	19"x21"x43.3"	63	100
AALC-MW-TH-EW	19"x21"x61.4"	81	100
AALC-IW-LH-SW	19"x29"x30.4"	63	100
AALC-IW-MH-SW	19"x29"x43.3"	81	100
AALC-IW-TH-SW	19"x29"x61.4"	102	100
AALC-JW-LH-EW	19"x43"x30.4"	82	100
AALC-JW-LH-SW	19"x43"x30.4"	82	100
AALC-JW-MH-EW	19"x43"x43.3"	105	100
AALC-JW-MH-SW	19"x43"x43.3"	105	100
AALC-JW-TH-EW	19"x43"x61.4"	134	100
AALC-JW-TH-SW	19"x43"x61.4"	134	100



Jumbo-Width / Tall Height



Jumbo-Width / Medium Height

Accelerator Storage Jumbo-Width with Totes & Shelves

The Alumni Accelerator Storage Jumbo-Width with Totes and Shelves are equipped with a combination of storage options to meet the needs of the students and teachers. By combining shelves and totes this becomes a space saving solution for modern classroom setting.

Model	Size	Wt. (lbs)	Freight Class
AALC-JW-TH-SH-12SW3	19"x43"x43.3"	134	100
AALC-JW-MH-SH-8SW3	19"x43"x61.4"	105	100

- Formed steel construction with the use of machine screw fasteners for the attachment of the panels, Jumbo-Width (43")
- Easy to Configure Adjustable Shelves
- 3" Standard Width (SW) Totes
- 100% Polyester Premium Metallic Powder Coat Finish (For Shelves, Top, Back, and Base Panels)
- 100% Polyester Premium Powder Coat Finish (For Side Panels)
- Standard Casters: 4" Casters, 5" Casters (dependant on unit size)
- Optional Glides: Fixed
- Options: Doors with Secure Lock, Whiteboard Back Panel, and Peg Board Sides
- Available Heights: Tall Height (61.4"), and Medium Height (43.3")



Jumbo-Width / Medium Height Shown with optional Doors



Jumbo-Width / Medium Height Shown with optional Doors



Jumbo-Width / Lower Height



Jumbo-Width / Medium Height



Jumbo-Width / Tall Height

Accelerator Jumbo-Width Cubby

The Alumni Accelerator Jumbo-Width Cubby provides an alternative storage solution to built-in units which enables teachers to configure their classrooms to meet the needs of their students. These mobile cubbies offer a convenient and space-saving option to be a great utility for all types of classroom settings.

Model	Size	Wt. (lbs)	Freight Class
AALC-JW-LH-6CUB	19"x43"x30.4"	97	100
AALC-JW-MH-9CUB	19"x43"x43.4"	128	100
AALC-JW-TH-12CUB	19"x43"x61.4"	135	100

- Formed steel construction with the use of machine screw fasteners for the attachment of the panels, Jumbo-Width (43")
- 100% Polyester Premium Metallic Powder Coat Finish (For Shelves, Top, Back, and Base Panels)
- 100% Polyester Premium Powder Coat Finish (For Side Panels)
- Standard Casters: 4" Casters, 5" Casters (dependant on unit size)
- Optional Glides: Fixed
- Options: Doors with Secure Lock, Whiteboard Back Panel (Available for specific sizes and heights)
- Available Heights: Tall Height (61.4"), Medium Height (43.3"), and Lower Height (30.4")





Accelerator Teacher Wardrobe

The Alumni Accelerator Teacher Wardrobe gives teachers a place to hang their belongings in a convenient location, while offering them the ability to store classroom supplies. The wardrobe is accessible to students and teachers, allowing a clear identification of everything being housed inside.

Model	Size	Wt. (lbs)	Freight Class
AALC-JW-TH-WD-24SW3	19"x43"x61.4"	147	100
AALC-JW-TH-WD-12SW6	19"x43"x61.4"	147	100
AALC-JW-TH-WD-6SW3-6SW6-2SW12	19"x43"x61.4"	147	100

- Formed steel construction with the use of machine screw fasteners for the attachment of the panels, Jumbo-Width (43") and Tall Height (61.4")
- Right or Left Wardrobe equipped with Shelf and Hook
- 3" Standard Width (SW) Totes
- 100% Polyester Premium Metallic Powder Coat Finish (For Shelves, Top, Back, and Base Panels)
- 100% Polyester Premium Powder Coat Finish (For Side Panels)
- Standard Casters: 4" Casters, 5" Casters (dependant on unit size)
- Optional Glides: Fixed
- Options: Doors with Secure Lock



Accelerator Active Learning Centers Material Selector

- | | | |
|--|---|--|
| Side Panels | | Top, Back and Base Panels |
| <ul style="list-style-type: none"> • Dark Gray • Pumpkin • Plum | <ul style="list-style-type: none"> • Apple Green • Ocean Blue | <ul style="list-style-type: none"> • Metallic |



Front View with Doors Open

Accelerator AV Power Cart

The Alumni Accelerator AV Power Cart has a variety of uses and multitude of functions. By providing a raised laminate top this allows for a second surface to meet the needs of the 21st Century Classrooms. This unit incorporates ventilation to help prevent overheating of technical equipment.

Model	Size	Wt. (lbs)	Freight Class
AALC-IW-LH-AVP-R	19"x29"x37"	98	100
AALC-JW-LH-AVP-R	19"x43"x37"	125	100

- 1 1/8" High Pressure Laminate (HPL) Top with Round Corner PVC Edge
- Formed steel construction with the use of machine screw fasteners for the attachment of the panels, Low Height (37"), with secured lockable doors
- Easy to Configure Adjustable Shelf
- 100% Polyester Premium Metallic Powder Coat Finish (For Shelf, Doors, Top, Back, and Base Panels)
- 100% Polyester Premium Powder Coat Finish (For Side Panels)
- Standard Casters: 4" Casters
- Optional Glides: Fixed
- Available Widths: Jumbo Width (43"), and Intermediate Width (29")



Front View

Back View

Accelerator Media Center Material Selector

- Laminate Top**
- | | | | | |
|-----------------|------------------|------------------|-------------------|-----------------|
| • Dark Walnut | • Loft Oak | • Gray Spectrum | • Agave Blue | • Primary Green |
| • Mahogany | • New Age Oak | • High Rise | • Eggplant Purple | • Primary Blue |
| • Wild Cherry | • Sugar Maple | • Vapour Strandz | • Pomegranate Red | • Primary Red |
| • Bannister Oak | • Cosmic Strandz | • Sprout Green | • Primary Yellow | |
- PVC Edge**
- | | | | |
|-------------|------------------|-----------------|---------------|
| • Black | • Maple | • Primary Green | • Sky Blue |
| • Charcoal | • Beige | • Apple Green | • Plum |
| • Warm Gray | • Pumpkin | • Navy Blue | • Crimson |
| • Gray | • Primary Yellow | • Primary Blue | • Primary Red |





Accelerator Sit Stand Teacher Desk Crescent

The Alumni Accelerator Sit-Stand Teacher Desk Crescent gives teachers versatility within the classroom. They can either extend their desk surface to create a temporary workspace for students or use it on its own as a mobile teaching station throughout the classroom.

- 1 1/8" High Pressure Laminate (HPL) Top with Round Corner PVC Edge
- Steel H-Style base with a steel pneumatic tube, adjustable height 29"-42"
- Available in 30" Crescent and 36" Crescent to pair with the Single Pedestal Teacher Desks
- 100% Polyester Premium Powder Coat Finish
- 2" Black Dual Wheel Locking Casters

Model	Size	Wt. (lbs)	Freight Class
ATD-SSR-30CRES	30" DIA	43	100
ATD-SSR-36CRES	36" DIA	49	100



Right Hand Pedestal Teacher Desk with Teacher Crescent



Shown with Alumni Air Lab Height Gas Lift Chair



Left Hand Pedestal with Bullet End



Double Pedestal

Accelerator Teacher Desk

The Alumni Accelerator Teacher Desk is designed to be a mobile and multipurpose work station. The desks are equipped with lockable single or double pedestals to meet individual teacher's needs. The standalone pedestal is space-conscious and adaptable to any environment.

- 1 1/8" High Pressure Laminate (HPL) Top with Round Corner PVC Edge
- 100% Polyester Premium Powder Coat Finish
- Fully welded steel pedestal with three locking drawers
- T-Leg support with steel modesty panel connected to single pedestal
- Double pedestals are connected by steel modesty panel
- 3" Dual Wheel Locking Casters
- Grommet for Wire Management
- Options: Single Pedestal Right Hand, Single Pedestal Left Hand, or Double Pedestal

Model	Size	Wt. (lbs)	Freight Class
ATD-2460-PD	24"x60"	146	100
ATD-2472-2PD	24"x72"	190	100
ATD-3060-PD	30"x60"	156	100
ATD-3072-2PD	30"x72"	200	100
ATD-PD-1924	19"x24"	44	100



Right Hand Pedestal with Bullet End



Pedestal

Accelerator Teacher Desk Material Selector

Laminate Top

- | | | | | |
|-----------------|------------------|------------------|-------------------|-----------------|
| • Dark Walnut | • Loft Oak | • Gray Spectrum | • Agave Blue | • Primary Green |
| • Mahogany | • New Age Oak | • High Rise | • Eggplant Purple | • Primary Blue |
| • Wild Cherry | • Sugar Maple | • Vapour Strandz | • Pomegranate Red | • Primary Red |
| • Bannister Oak | • Cosmic Strandz | • Sprout Green | • Primary Yellow | |

PVC Edge

- | | | | |
|-------------|------------------|-----------------|---------------|
| • Black | • Maple | • Primary Green | • Sky Blue |
| • Charcoal | • Beige | • Apple Green | • Plum |
| • Warm Gray | • Pumpkin | • Navy Blue | • Crimson |
| • Gray | • Primary Yellow | • Primary Blue | • Primary Red |

Frame

- | | |
|--------------------|----------------|
| • Black | • Gray |
| • Hammertone Black | • Metallic |
| • Hammertone Gray | • Beige |
| • Dark Gray | • Hunter Green |
| • Navy Blue | • Apple Green |
| • Burgundy | • Ocean Blue |
| • Pumpkin | |
| • Plum | |



Accelerator Active Learning Centers Chart

Micro-Width

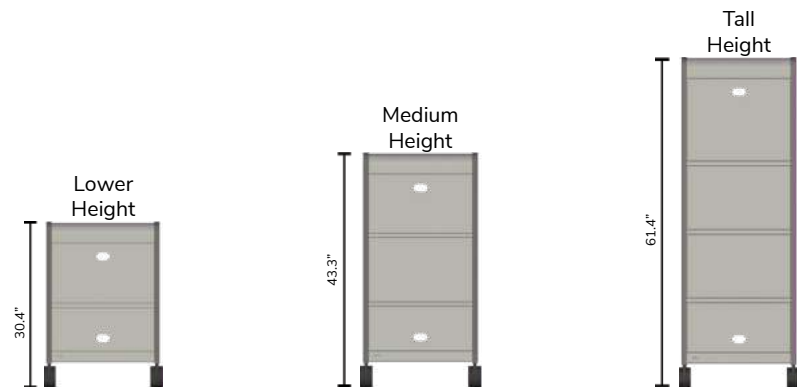

Intermediate-Width

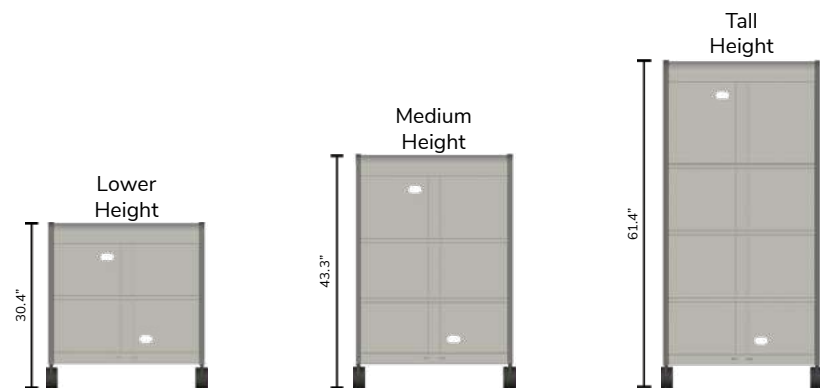

Jumbo-Width

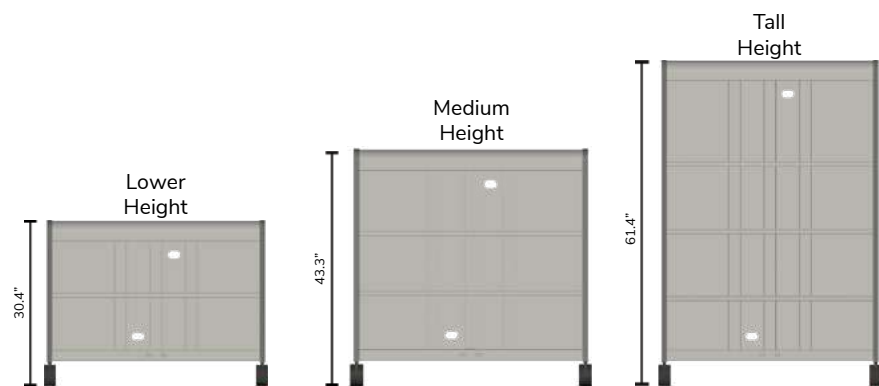

Cubby

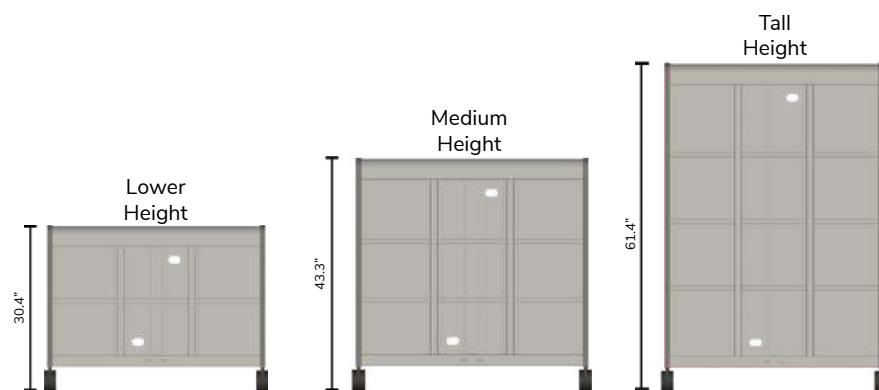

Teacher Wardrobe

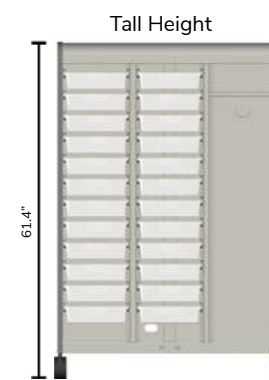

Media Center

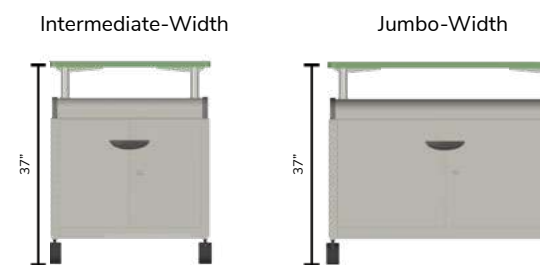

Sizing- Top Views

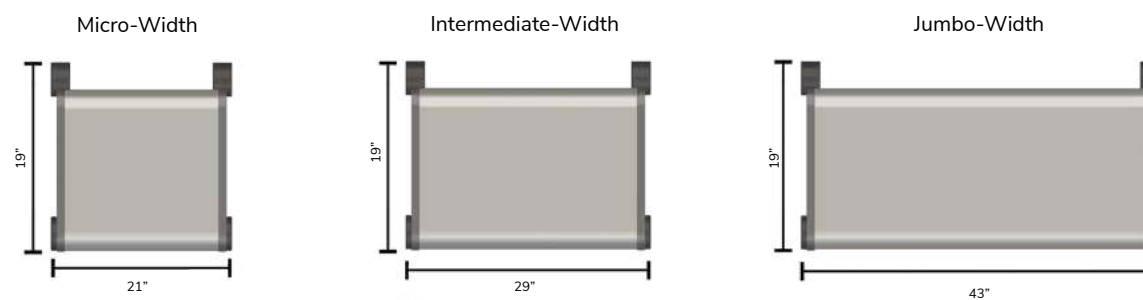
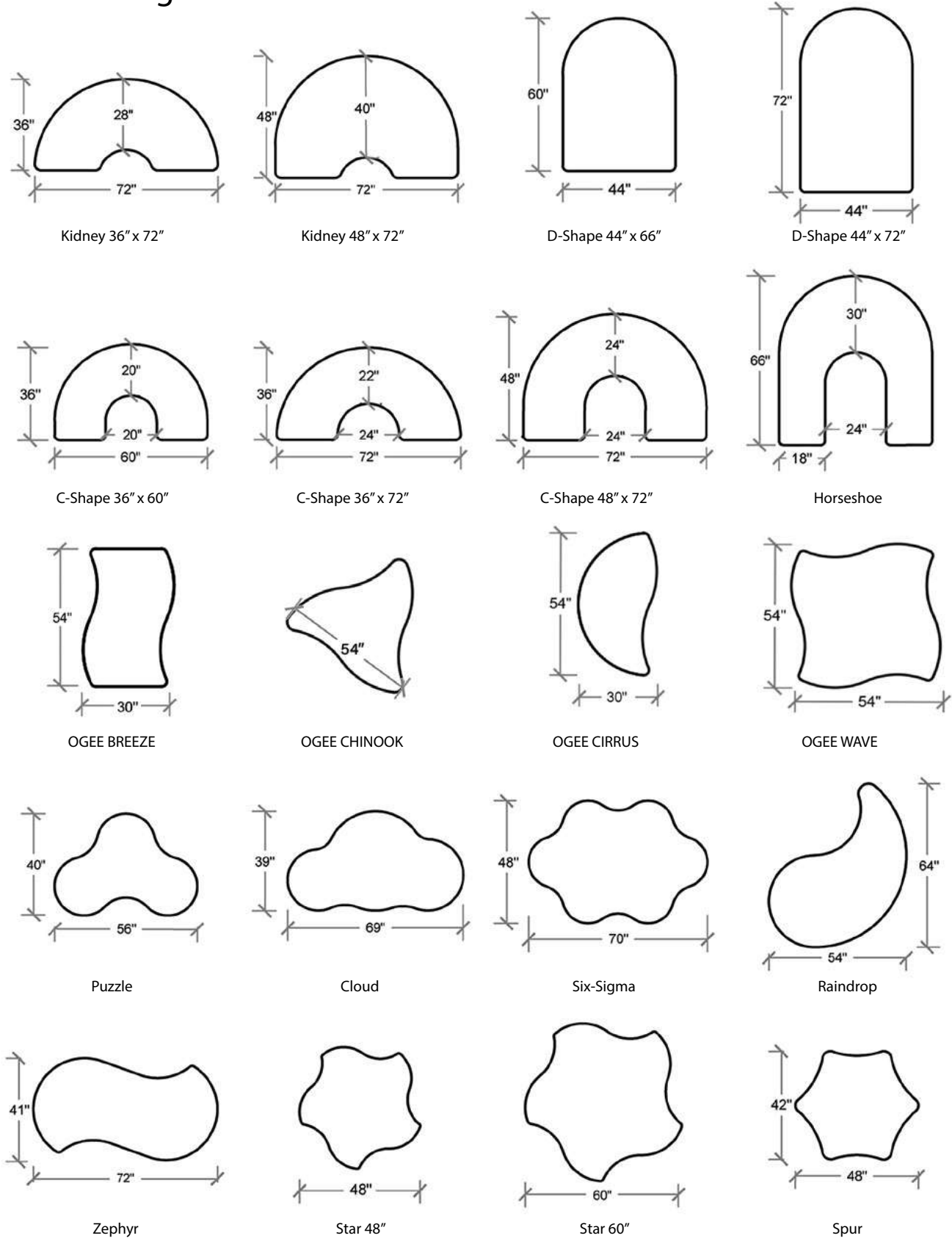
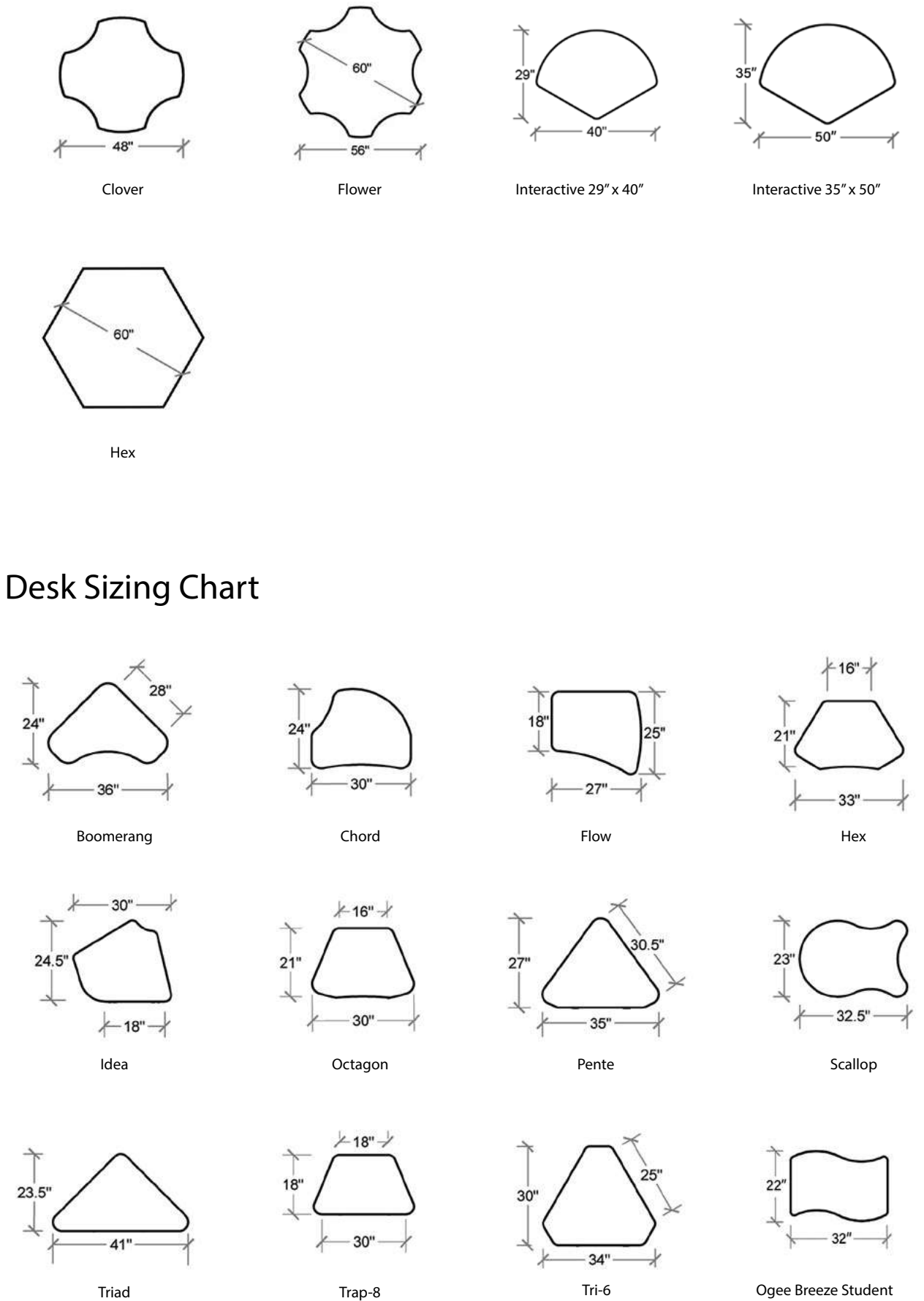

Table Sizing Chart



Desk Sizing Chart



Frame

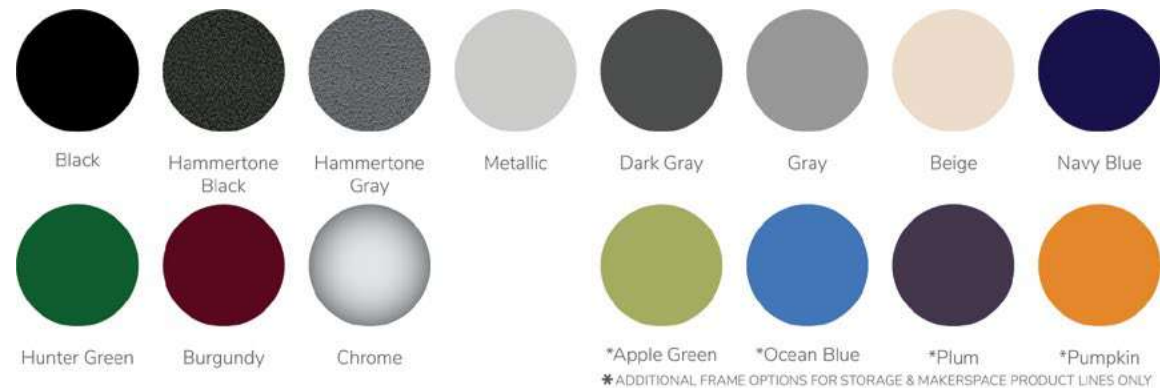

PVC Edge



Laminate Tops



Hard Plastic Tops



Polypropylene Chair Shells & Book Box



Hard Plastic Seats/Backs/Stools

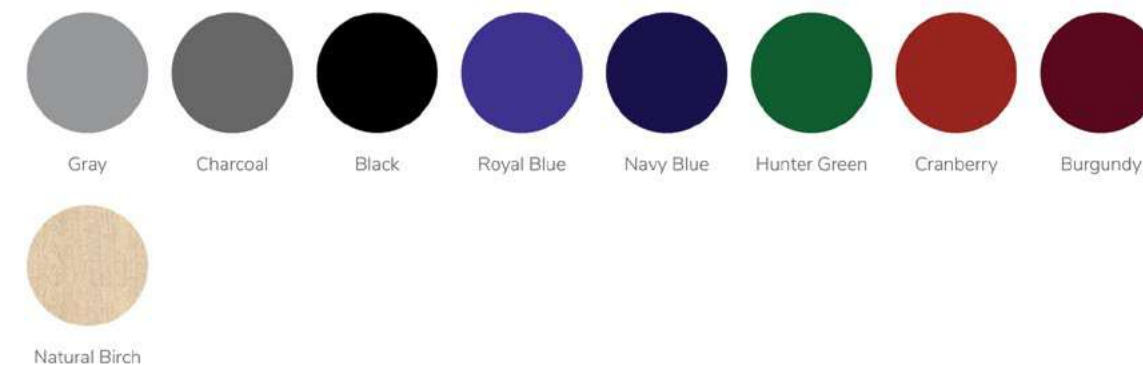

Balance Stool Seats

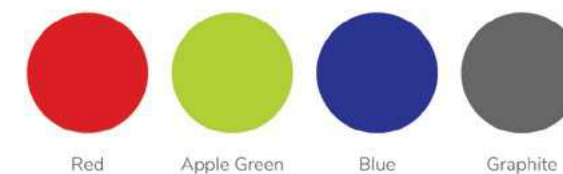

4-Leg Chair Glides



Marquis Swivel Nylon Glide



Marquis Swivel Neoprene Glide



Marquis Swivel Steel Glide



Felt Snap-On Glide



Vinyl Insert Glide



Q-Ball Glide



Quiet Glide



Dual Wheel Urethane Caster

Cantilever and Rocker Chair Glides



Floor Friendly Rear Glide



Floor Friendly Front Glide



Stainless Steel Rear Glide



Stainless Steel Front Glide



Cafe Height Cantilever Rear Glide



Cafe Height Cantilever Front Glide



Rocker Floor Friendly Rear Glide



Rocker Floor Friendly Front Glide

Gas Lift Chair Casters & Glides



Caster



Fixed Glide

Round Leg Desk Glides and Casters



Marquis Swivel Nylon Glide



Marquis Swivel Neoprene Glide



Marquis Swivel Steel Glide



Felt Snap-On Glide



Vinyl Insert Glide



Q-Ball Glide



Quiet Glide



Dual Wheel Urethane Caster

Cantilever Glides



Floor Friendly Rear Glide



Floor Friendly Front Glide



Stainless Steel Rear Glide



Stainless Steel Front Glide

Oval, Inspire, Square, and T Leg Glides



Adjustable Floor Friendly Glide



Adjustable Stainless Steel Glide



Vinyl Insert Glide
*Square Leg Only

Table Casters



4" Caster



3" Convertible Bench Table Caster



3" Locking Caster

Additional Chair Options

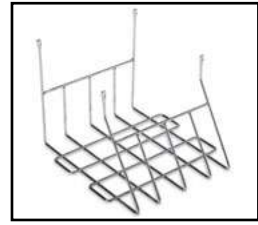

Book Rack



Ganging

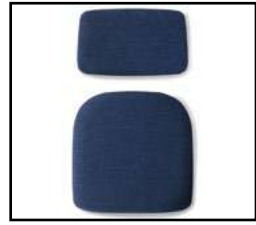

Padded Seat and/or Back

Additional Desk and Table Options



Steel Perforated Book Box



Pass-Through Book Box



Wire Shelf



Plastic Book Box



Plastic Totes



Bag Hook



Grommet

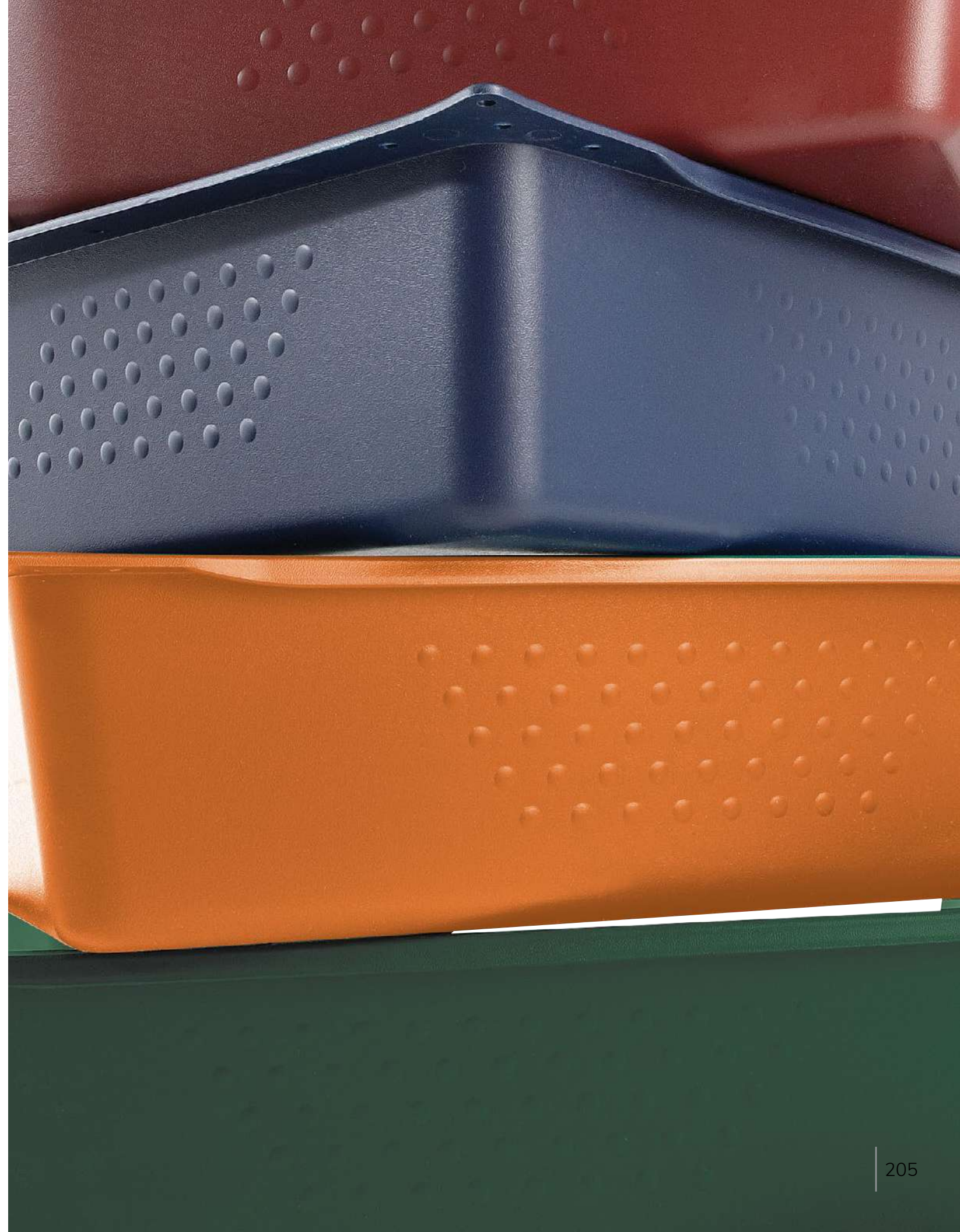

Customer Support

Purchase Orders

Be sure to include:

- Quantity
- Model Number
- Description
- Color Choice (top, edge, frame color, shell for chairs)
- Price for each item including quote number is required as well

Alumni accepts orders via:

- Email: orders@alumnif.com
- Fax: 519.888.9395

Terms

Invoice terms for credit accounts are NET 30 days. Orders are invoiced on day of shipment. New customers are subject to credit application approval process.

Delivery

Product shipping weights are for product only. LTL shipments are sent on pallets. Pallet weights will be added to total weight for LTL shipments. Standard LTL shipments do not include additional accessorials.

Alumni will determine the mode and method which meet the best delivery criteria.

Freight

Do not refuse freight because of damage or shortage. All merchandise is packed to comply with carrier requirements. For your protection all shipments should be carefully inspected by the consignee before acceptance. The delivering carrier should be requested to record on the delivery receipt any damage to goods or cartons at time of delivery. Also, any shortages should be noted on the delivery receipt. If further damage is found after delivery, immediate notification of Alumni must occur and all cartons and merchandise must be held for inspection. Alumni will notify you if the inspection will take place or if the product is to be disposed. Please contact Alumni at customerexperience@alumnif.com to initiate the process.

Warranty

Alumni Educational Solutions has a Limited 15 Year Warranty. For complete details and a copy please contact Customer Experience at customerexperience@alumnif.com or call 1.833.939.9300.

CONTRIBUTING TO A GREEN PLANET



As a responsible member of the business community, it is our ambition to work towards easing the impact that manufacturing has on our environment. Our ongoing efforts are driving us towards sustainability as we are committed to leaving the environment better than we found it.

REDUCE. REUSE. RECYCLE.

Alumni applies a concentrated effort to the three R's within our production, packaging and shipment process. The result of our motivation is having a cleaner environment that produces less waste and uses as many recyclable materials as possible. The policy of Reduce, Reuse, Recycle is so important to us that even this catalog is printed on recycled paper.

Alumni has implemented a Safe Materials Testing Program (SMTP) to ensure that all materials that are used meet or exceed Federal Regulation. Our products are tested to meet ASTM, NEMA and Fed Spec Standards as well. Alumni uses Internationally Renowned Testing Labs to ensure product safety and quality.

We want our children to grow up in a healthy environment so that their children can do the same.



Alumni Classroom Furniture is compliant with the testing requirements in the Consumer Product Safety Improvement Act 2008.



CONTACT ALUMNI EDUCATIONAL SOLUTIONS

Locations in:

Toronto (Area), Ontario, Canada
Temple, Texas, USA

International Head Office

210 Regina St. N, P.O. Box 549
Waterloo, Ontario, Canada N2J 3B6
Toll Free: 1-833-939-9300
Fax: 519-888-9395
www.alumnicf.com
info@alumnicf.com

AE S

ALUMNI EDUCATIONAL SOLUTIONS