

motionoffice®



product selector

Delivery Times

Stock Items: Finishes/combinations shown in this pricelist - 10 days

Standard Projects: Standard components, alternate mix of 'Motion Felt' / Eurotex PU upholstery - 70 days

Custom Projects: Non-standard components or non-standard upholstery - 100 days

Warranty

Frame: 10 years

Fabric: Motion Felt 5 years

Eurotex PU: 2 years

Freight

Please check with your Distributor for Freight Policy.

Assembly

Assembly is required for the majority of MotionOffice products and is not included in the product price.

Custom Items

30% deposit is required on custom orders. All custom orders must go through the MotionOffice Configurator at motionoffice.com or any custom items not shown in this document or on the configurator must go through a sign off process. The above delivery times maybe subject to change based on fabric & order information and international holidays. Some custom fabrics according to manufacturers specifications may be unsuitable. Please check with your MotionOffice sales representative when placing your order.

Acoustics Certification.....	4
Wave Individual.....	7
Zip Individual.....	8
Shell Individual.....	10
Link Individual.....	11
Team Collaborative.....	12
Meeting Collaborative.....	13
Grandstand Collaborative.....	14
Ring Collaborative.....	16
Expo Collaborative.....	17
Arc Collaborative.....	18
Disc Collaborative.....	22
Otto Flexible.....	23
Wing Flexible.....	24
Fin Flexible.....	24
Cape Flexible.....	25
Canopy Flexible.....	25
Loop Flexible.....	28
Tables Flexible.....	30
Luna Seating.....	32
Motion Sync Seating.....	34
Free Chair Seating.....	34
Accessories Custom.....	35
Power & Data Custom.....	36
Fabric & Finishes Custom.....	38
Dimensions	42

Standard wall materials absorb 3%, MotionOffice has been tested and absorbs 76% of sound waves!

Imagine standing in the middle of a room with all concrete surfaces and one open window, and you blow a loud whistle. The sound that hits the open window passes right through. The sound that hits the concrete surfaces in the room begin to reflect back. The NRC (Noise Reduction Coefficient) of the open window would be 1.00 which is the absence of sound reflection. The NRC of concrete is .03, indicating that 97% of the noise that hits the concrete surfaces will reflect back off the surface. The NRC value of a surface simply denotes its ability to absorb vs reflect sound. The higher the NRC value, the stronger the sound absorption and the lower the sound reflection in the room.

MotionOffice panels have an NRC rating of 0.76 which means that 76% of the sound wave entering into the material will be captured and converted. MotionOffice dramatically contributes to reduction of noise bleed in open plan environments!

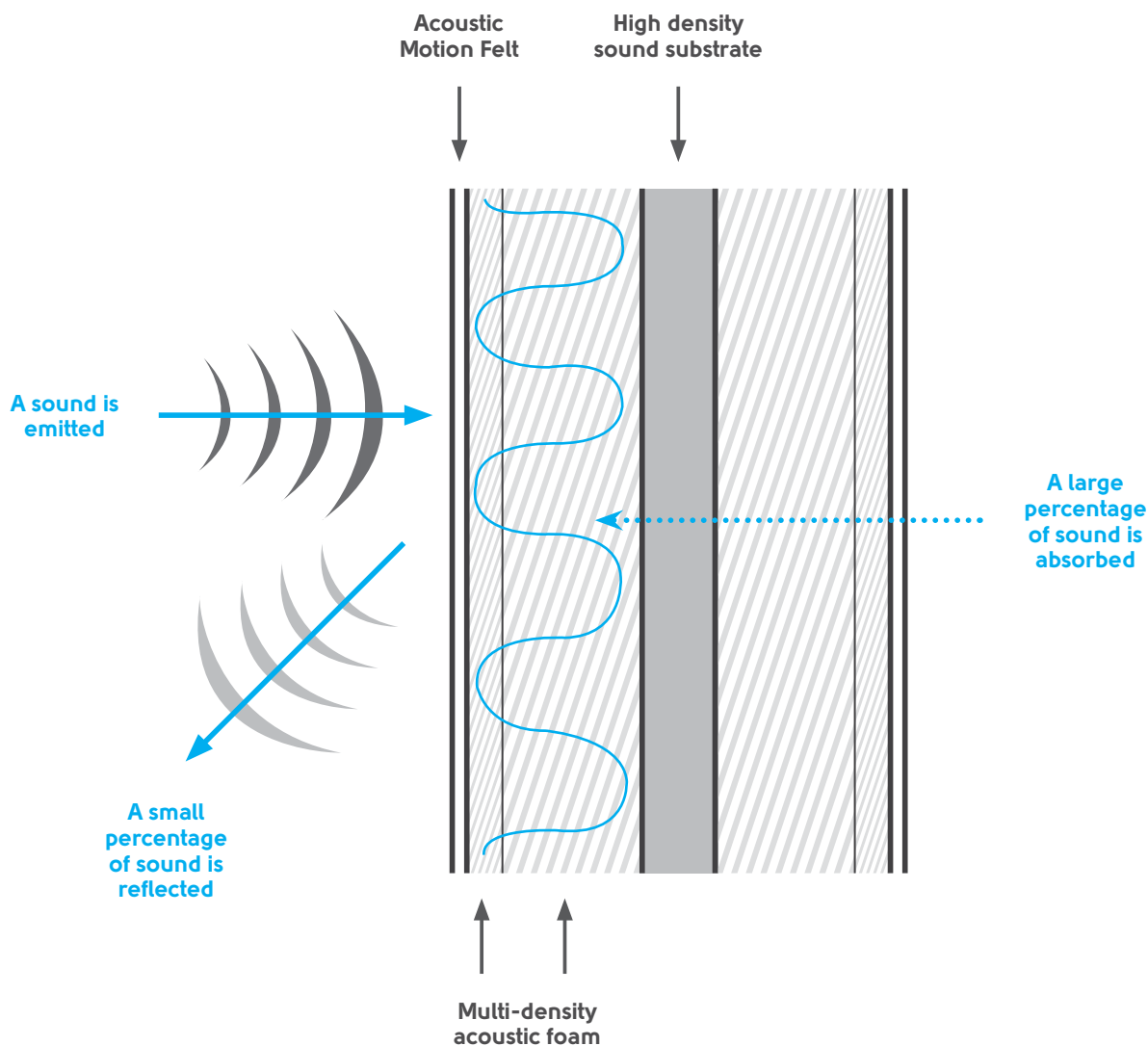

MotionOffice Acoustics - absorbs 76% of sound waves!

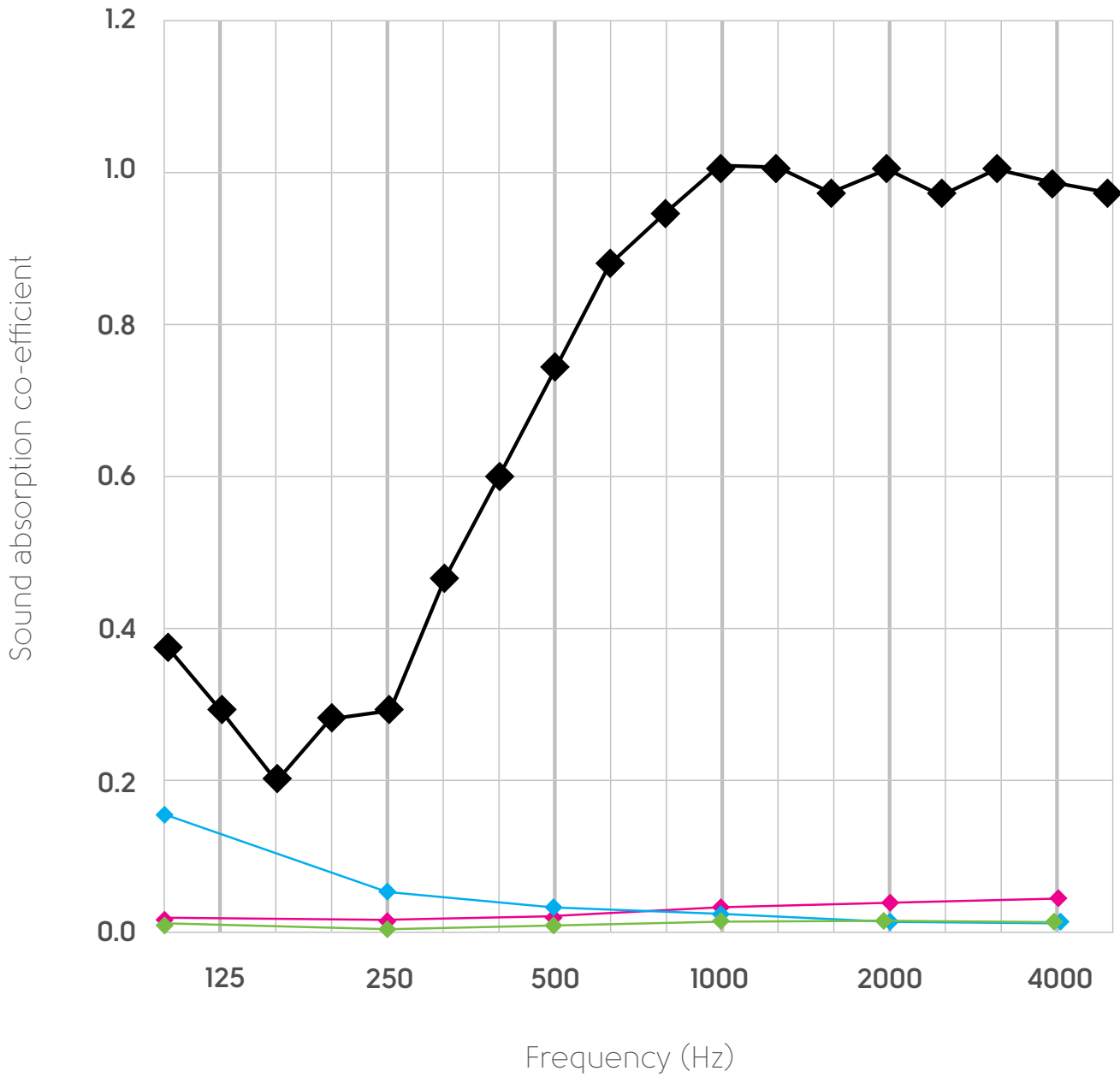





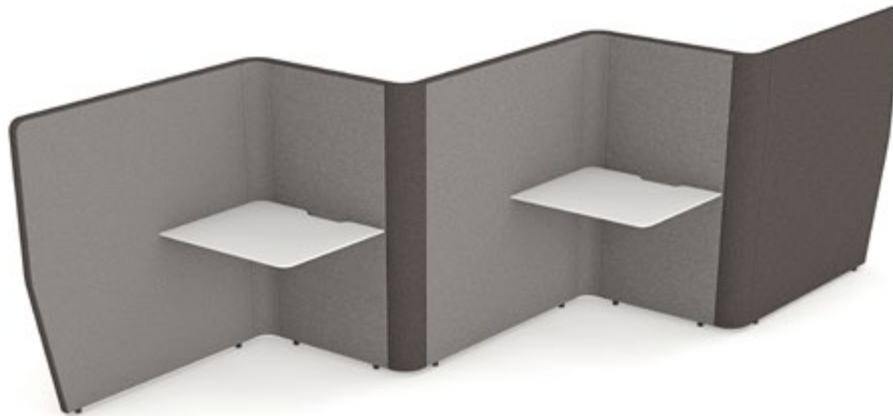

KEY:

- MotionOffice Materials
- Glass
- Concrete
- Gypsum Board (Gib Board)

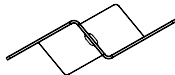

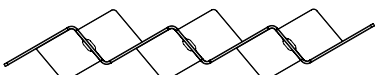

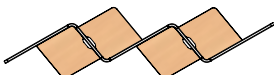
For product dimensions please refer to back of product selector



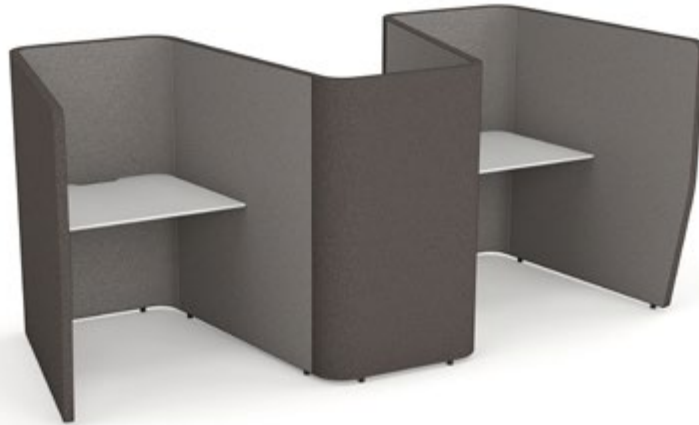

	STOCK CODE	DESCRIPTION	WORKTOP
Complete with Lacquered White Worktops			
	MWAV2CLST_BE	Motion Wave 2 Includes 2x Motion Wave Worktops	Lacquered White
	MWAV4CLST_BE	Motion Wave 4 Includes 4x Motion Wave Worktops	Lacquered White
	MWAV6CLST_LW	Motion Wave 6 Includes 6x Motion Wave Worktops	Lacquered White
Complete with Solid Beech Worktops			
	MWAV2CLST_BE	Motion Wave 2 Includes 2x Motion Wave Worktops	Solid Beech
	MWAV4CLST_BE	Motion Wave 4 Includes 4x Motion Wave Worktops	Solid Beech
	MWAV6CLST_BE	Motion Wave 6 Includes 6x Motion Wave Worktops	Solid Beech

*For information on power options please contact your MotionOffice supplier.

*MotionOffice is a modular system. If your floor plan requires alternate layouts to these shown here, please contact your MotionOffice supplier.

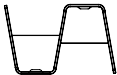
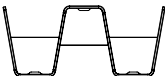

For product dimensions please refer to back of product selector

	STOCK CODE	DESCRIPTION	WORKTOP
Complete with Lacquered White Worktops			
	MZIP1CLST_LW	Motion Zip 1 Includes 1x Motion Zip Worktop	Lacquered White
	MZIP2CLST_LW	Motion Zip 2 Includes 2x Motion Zip Worktops	Lacquered White
	MZIP3CLST_LW	Motion Zip 3 Includes 3x Motion Zip Worktops	Lacquered White
	MZIP4CLST_LW	Motion Zip 4 Includes 4x Motion Zip Worktops	Lacquered White
	MZIP5CLST_LW	Motion Zip 5 Includes 5x Motion Zip Worktops	Lacquered White
	MZIP6CLST_LW	Motion Zip 6 Includes 6x Motion Zip Worktops	Lacquered White

Upgrade

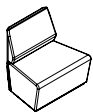

MLPW7_CLST **Motion Wedge**
Use with Zip and Shell

**For information on power options please contact your MotionOffice supplier.*

**MotionOffice is a modular system. If your floor plan requires alternate layouts to these shown here, please contact your MotionOffice supplier.*



Shown with optional Motion Wedge upgrade

For product dimensions please refer to back of product selector

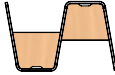
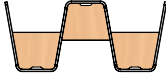
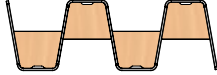
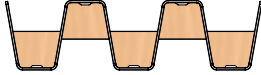
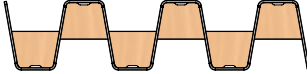
	STOCK CODE	DESCRIPTION	WORKTOP
Complete with Solid Beech Worktops			
	MZIP1CLST_BE	Motion Zip 1 Includes 1x Motion Zip Worktop	Solid Beech
	MZIP2CLST_BE	Motion Zip 2 Includes 2x Motion Zip Worktops	Solid Beech
	MZIP3CLST_BE	Motion Zip 3 Includes 3x Motion Zip Worktops	Solid Beech
	MZIP4CLST_BE	Motion Zip 4 Includes 4x Motion Zip Worktops	Solid Beech
	MZIP5CLST_BE	Motion Zip 5 Includes 5x Motion Zip Worktops	Solid Beech
	MZIP6CLST_BE	Motion Zip 6 Includes 6x Motion Zip Worktops	Solid Beech

Upgrade

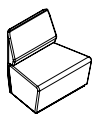

MLPW7_CLST **Motion Wedge**
Use with Zip and Shell

*For information on power options please contact your MotionOffice supplier.
*MotionOffice is a modular system. If your floor plan requires alternate layouts to these shown here, please contact your MotionOffice supplier.

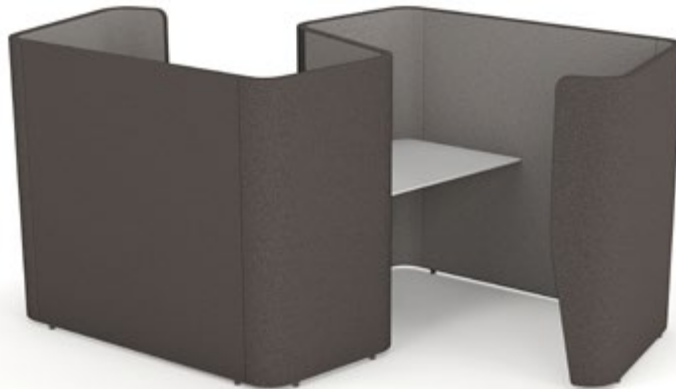



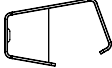
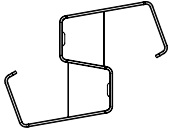
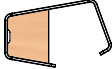
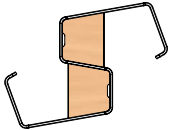
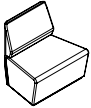

For product dimensions please refer to back of product selector

STOCK CODE	DESCRIPTION	WORKTOP
Complete with Lacquered White Worktops		
	MSHEL1CLST_LW Motion Shell 1 Includes Motion Shell Worktop	Lacquered White
	MSHEL2CLST_LW Motion Shell 2 Includes 2x Motion Shell Worktops	Lacquered White
Complete with Solid Beech Worktops		
	MSHEL1CLST_BE Motion Shell 1 Includes Motion Shell Worktop	Solid Beech
	MSHEL2CLST_BE Motion Shell 2 Includes 2x Motion Shell Worktops	Solid Beech
Upgrade		
	MLPW7_CLST Motion Wedge Use with Zip and Shell	

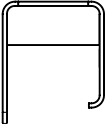

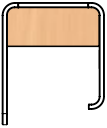
For product dimensions please refer to back of product selector

STOCK CODE	DESCRIPTION	WORKTOP
Complete with Lacquered White Worktops		
	MLKFSCCLST_LW Motion Link - Freestanding Phone Booth Includes Motion Link Worktop	Lacquered White
	MLKWMCLST_LW Motion Link - Wall Mounted Phone Booth Includes Motion Link Worktop	Lacquered White
Complete with Solid Beech Worktops		
	MLKFSCCLST_BE Motion Link - Freestanding Phone Booth Includes Motion Link Worktop	Solid Beech
	MLKWMCLST_BE Motion Link - Wall Mounted Phone Booth Includes Motion Link Worktop	Solid Beech

*For more information on alternate fabric and power/data options please contact your MotionOffice supplier.



For product dimensions please refer to back of product selector

STOCK CODE	DESCRIPTION	WORKTOP
Complete with Lacquered White Worktops		

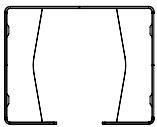

MTM4CLST_LW
Motion Team
 Includes 2x Motion Team Worktops

Lacquered White

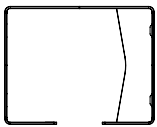

MTM2CLST_LW
Motion Team
 Includes 1x Motion Team Worktops

Lacquered White

Complete with Solid Beech Worktops		
---	--	--

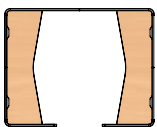

MTM4CLST_BE
Motion Team
 Includes 2x Motion Team Worktops

Solid Beech

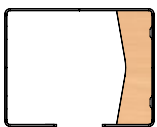

MTM2CLST_LW
Motion Team
 Includes 1x Motion Team Worktops

Solid Beech

**For information on power options please contact your MotionOffice supplier.*

**MotionOffice is a modular system. If your floor plan requires alternate layouts to these shown here, please contact your MotionOffice supplier.*



Backrest Covers

Please specify your chosen colour at time of original order. Additional charges will apply for fabric covers ordered after original supply. For code and colour options see page 26 & 27.

For product dimensions please refer to back of product selector

STOCK CODE	DESCRIPTION	TABLE
Complete with Lacquered White Table		

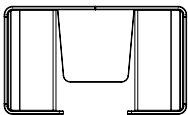

MCPMT4CLST_LW

Motion Meeting
Includes Motion Meeting Table

Lacquered White

Complete with Solid Beech Table		
--	--	--

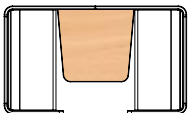

MCPMT4CLST_BE

Motion Meeting
Includes Motion Meeting Table

Solid Beech

**For information on power options please contact your MotionOffice supplier.*

**MotionOffice is a modular system. If your floor plan requires alternate layouts to these shown here, please contact your MotionOffice supplier.*

Grandstand > Collaborative





Motion Grandstand 3 Tier
Stone/Charcoal



Motion Grandstand 2 Tier
Charcoal/Stone

For product dimensions please refer to back of product selector

STOCK CODE	DESCRIPTION
	MGRAND2T_CLST Motion Grandstand 2 Tier - Charcoal/Stone
	MGRAND2T_STCL Motion Grandstand 2 Tier - Stone/Charcoal
	MGRAND3T_CLST Motion Grandstand 3 Tier - Charcoal/Stone
	MGRAND3T_STCL Motion Grandstand 3 Tier - Stone/Charcoal

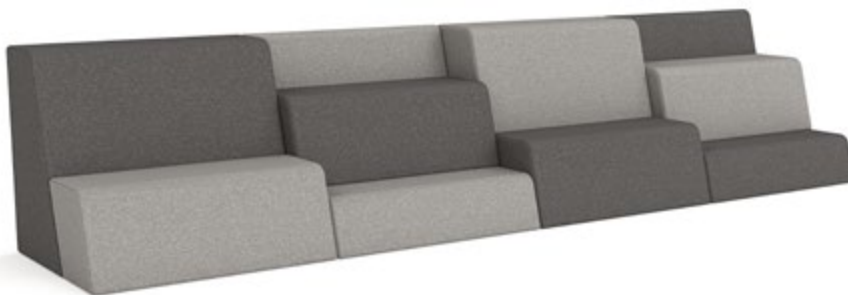

**Motion Grandstand
Example 1**

2 x Motion Grandstand 2 Tier
2 x Motion Grandstand 3 Tier

CODE: MGRAND4EX1_CLST

**For information on power options please contact your MotionOffice supplier.*

**MotionOffice is a modular system. If your floor plan requires alternate layouts to these shown here, please contact your MotionOffice supplier.*

Grandstand > Collaborative

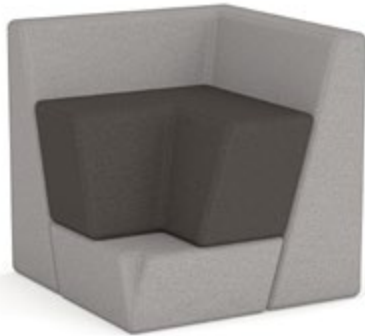

Motion Grandstand 90° 3 Tier
Stone/Charcoal

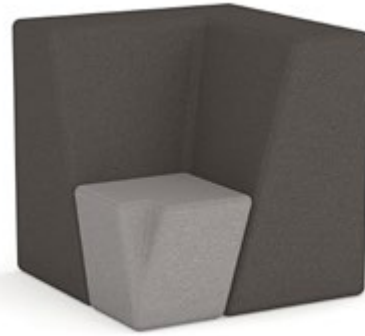

Motion Grandstand 90° 2 Tier
Charcoal/Stone

For product dimensions please refer to back of product selector

STOCK CODE	DESCRIPTION
MGRAND902T_CLST	Motion Grandstand 90° 2 Tier - Charcoal/Stone
MGRAND902T_STCL	Motion Grandstand 90° 2 Tier - Stone/Charcoal
MGRAND903T_CLST	Motion Grandstand 90° 3 Tier - Charcoal/ Stone
MGRAND903T_STCL	Motion Grandstand 90° 3 Tier - Stone/Charcoal



**Motion Grandstand
Example 2**

2 x Motion Grandstand 2 Tier
1 x Motion Grandstand 3 Tier
1 x Motion Grandstand 90° 2 Tier

CODE: MGRAND4EX2_CLST

*For information on power options please contact your MotionOffice supplier.

*MotionOffice is a modular system. If your floor plan requires alternate layouts to these shown here, please contact your MotionOffice supplier.

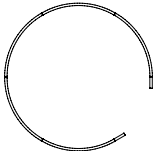
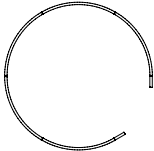
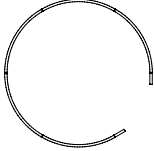

For product dimensions please refer to back of product selector

STOCK CODE	DESCRIPTION
 MRING20_CLST	Motion Ring Includes 2000mm walls Excludes Motion Round Table
 MRING14_CLST	Motion Ring Includes 1400mm walls Excludes Free Chair and Motion Coffee Table
 MRING11_CLST	Motion Ring Includes 1100mm walls Excludes Motion Otto's and Motion Coffee Table

**For information on power options please contact your MotionOffice supplier.*

**MotionOffice is a modular system. If your floor plan requires alternate layouts to these shown here, please contact your MotionOffice supplier.*



For product dimensions please refer to back of product selector

STOCK CODE	DESCRIPTION	WORKTOP
Complete with Lacquered White Worktop		

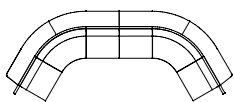

MEXPO6CLST_LW

Motion Expo

Lacquered White

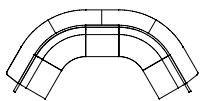

MEXPO5CLST_LW

Motion Expo - Medium

Lacquered White

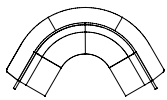

MEXPO4CLST_LW

Motion Expo - Small

Lacquered White

Complete with Solid Beech Worktop		
--	--	--

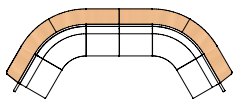

MEXPO6CLST_BE

Motion Expo - Large

Solid Beech

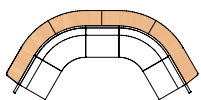

MEXPO5CLST_BE

Motion Expo - Medium

Solid Beech

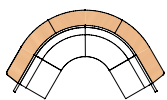

MEXPO4CLST_BE

Motion Expo - Small

Solid Beech



Shown with optional Motion Round Table, see page 30 & 31.

For product dimensions please refer to back of product selector

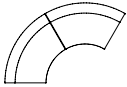
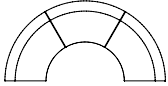
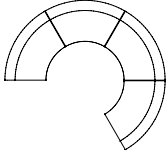
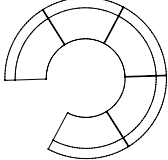
STOCK CODE	DESCRIPTION
 MARC2_CLST	<p>Motion Arc 2 2 x Motion Loop - Curved 60° Outer Back Excludes Motion Round Table</p>
 MARC3_CLST	<p>Motion Arc 3 3 x Motion Loop - Curved 60° Outer Back Excludes Motion Round Table</p>
 MARC4_CLST	<p>Motion Arc 4 4 x Motion Loop - Curved 60° Outer Back Excludes Motion Round Table</p>
 MARC5_CLST	<p>Motion Arc 5 5 x Motion Loop - Curved 60° Outer Back Excludes Motion Round Table</p>

**For information on power options please contact your MotionOffice supplier.*

**MotionOffice is a modular system. If your floor plan requires alternate layouts to these shown here, please contact your MotionOffice supplier.*

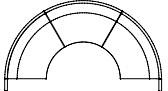
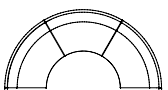
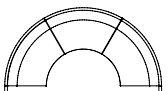

For product dimensions please refer to back of product selector

STOCK CODE	DESCRIPTION
	<p>Motion Arc 3 - Low 3 x Motion Loop - Curved 60° Outer Back 1100mm walls</p>
	<p>Motion Arc 3 - Mid 3 x Motion Loop - Curved 60° Outer Back 1400mm walls</p>
	<p>Motion Arc 3 - High 3 x Motion Loop - Curved 60° Outer Back 2000mm walls</p>

*For information on power options please contact your MotionOffice supplier.

*MotionOffice is a modular system. If your floor plan requires alternate layouts to these shown here, please contact your MotionOffice supplier.



For product dimensions please refer to back of product selector

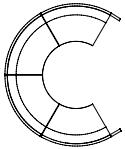
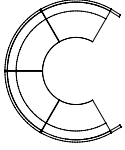
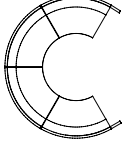
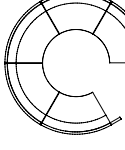
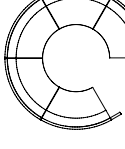
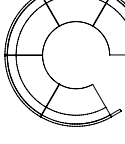



STOCK CODE	DESCRIPTION
	<p>Motion Arc 4 - Low 4 x Motion Loop - Curved 60° Outer Back 1100mm walls</p>
	<p>Motion Arc 4 - Mid 4 x Motion Loop - Curved 60° Outer Back 1400mm walls</p>
	<p>Motion Arc 4 - High 4 x Motion Loop - Curved 60° Outer Back 2000mm walls</p>
	<p>Motion Arc 5 - Low 5 x Motion Loop - Curved 60° Outer Back 1100mm walls</p>
	<p>Motion Arc 5 - Mid 5 x Motion Loop - Curved 60° Outer Back 1400mm walls</p>
	<p>Motion Arc 5 - High 5 x Motion Loop - Curved 60° Outer Back 2000mm walls</p>

**For information on power options please contact your MotionOffice supplier.*

**MotionOffice is a modular system. If your floor plan requires alternate layouts to these shown here, please contact your MotionOffice supplier.*

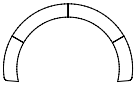
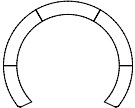

For product dimensions please refer to back of product selector

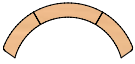
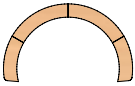
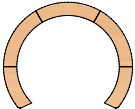
	STOCK CODE	DESCRIPTION	WORKTOP
Lacquered White Worktop			
	MARC2STOP_LW	Motion Arc 2 Segment Worktop Suits 1100mm walls only	Lacquered White
	MARC3STOP_LW	Motion Arc 3 Segment Worktop Suits 1100mm walls only	Lacquered White
	MARC4STOP_LW	Motion Arc 4 Segment Worktop Suits 1100mm walls only	Lacquered White
	MARC5STOP_LW	Motion Arc 5 Segment Worktop Suits 1100mm walls only	Lacquered White
Solid Beech Worktop			
	MARC2STOP_BE	Motion Arc 2 Segment Worktop Suits 1100mm walls only	Solid Beech
	MARC3STOP_BE	Motion Arc 3 Segment Worktop Suits 1100mm walls only	Solid Beech
	MARC4STOP_BE	Motion Arc 4 Segment Worktop Suits 1100mm walls only	Solid Beech
	MARC5STOP_BE	Motion Arc 5 Segment Worktop Suits 1100mm walls only	Solid Beech



Shown with optional Motion Disc Centre Infill

For product dimensions please refer to back of product selector

STOCK CODE	DESCRIPTION
------------	-------------

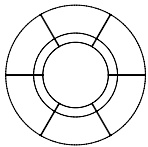

MDISC6_CLST

Motion Disc 6
6 x Motion Loop Curved 60° Inner Back

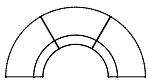

MDISC3_CLST

Motion Disc 3
3 x Motion Loop Curved 60° Inner Back

Lacquered White Infill



MDISCTOP_LW

Motion Disc Centre Infill
Includes top and legs

Lacquered White

Solid Beech Worktop Infill



MDISCTOP_BE

Motion Disc Centre Infill
Includes top and legs

Solid Beech

**For information on power options please contact your MotionOffice supplier.*

**MotionOffice is a modular system. If your floor plan requires alternate layouts to these shown here, please contact your MotionOffice supplier.*



Otto Covers

Please specify your chosen colour at time of original order, any colour change or additional covers required there after will be priced as below.

For product dimensions please refer to back of product selector

STOCK CODE	DESCRIPTION
MOSTOOL_ST	Motion Otto Includes Castors / Stone Grey Cover
MOTTOCOV_#	Motion Otto Cover Motion Felt

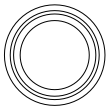

= Please specify the code of your chosen colour when ordering.

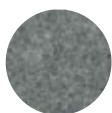

Ash Grey
#= AS

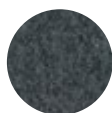

Stone Grey
#= ST



Charcoal Grey
#= CL



Deep Blue
#= DB

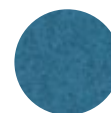

Ice Blue
#= IC



Emerald Green
#= EM

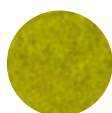

Bumblebee Yellow
#= BB



Avocado Green
#= AV



Sunset Orange
#= SO



Chilli Red
#= CR



Backrest Covers

Please specify your chosen colour at time of original order. Additional charges will apply for fabric covers ordered after original supply. For code and colour options see page 26 & 27.

For product dimensions please refer to back of product selector

STOCK CODE	DESCRIPTION
------------	-------------

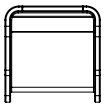

MWNG1_CLST **Motion Wing 1**

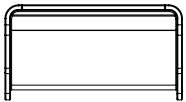

MWNG2_CLST **Motion Wing 2**



Backrest Covers

Please specify your chosen colour at time of original order. Additional charges will apply for fabric covers ordered after original supply. For code and colour options see page 26 & 27.

For product dimensions please refer to back of pricelist

STOCK CODE	DESCRIPTION
------------	-------------

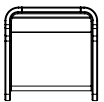

MFIN1_CLST **Motion Fin 1**

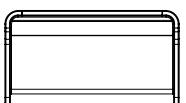

MFIN2_CLST **Motion Fin 2**



Backrest Covers

Please specify your chosen colour at time of original order. Additional charges will apply for fabric covers ordered after original supply. For code and colour options see page 26 & 27.

For product dimensions please refer to back of product selector

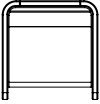
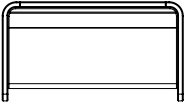
STOCK CODE	DESCRIPTION
 MCAP1_CLST	Motion Cape 1
 MCAP2_CLST	Motion Cape 2



Backrest Covers

Please specify your chosen colour at time of original order. Additional charges will apply for fabric covers ordered after original supply. For code and colour options see page 26 & 27.

For product dimensions please refer to back of pricelist





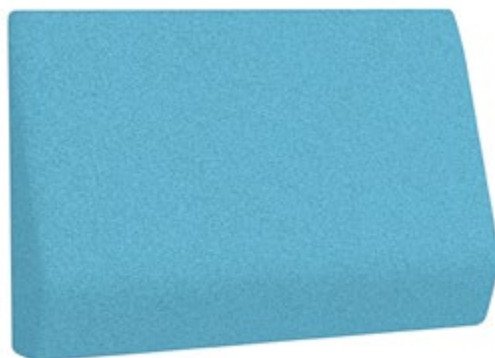





STOCK CODE	DESCRIPTION
 MCANOPY2_CLST	Motion Canopy 2

**For information on power options please contact your MotionOffice supplier.*



Backrest Covers





Please specify your chosen colour at time of original order. Additional charges will apply for fabric covers ordered after original supply. For code and colour options see below.

STOCK CODE	DESCRIPTION
 MBKCOV06_AS	Motion Backrest Cover 650mm - Ash Grey Suitable for Wing 1, Fin 1 and Cape 1
 MBKCOV06_ST	Motion Backrest Cover 650mm - Stone Grey Suitable for Wing 1, Fin 1 and Cape 1
 MBKCOV06_CL	Motion Backrest Cover 650mm - Charcoal Grey Suitable for Wing 1, Fin 1 and Cape 1
 MBKCOV06_DB	Motion Backrest Cover 650mm - Deep Blue Suitable for Wing 1, Fin 1 and Cape 1
 MBKCOV06_IC	Motion Backrest Cover 650mm - Ice Blue Suitable for Wing 1, Fin 1 and Cape 1
 MBKCOV06_EM	Motion Backrest Cover 650mm - Emerald Green Suitable for Wing 1, Fin 1 and Cape 1
 MBKCOV06_BB	Motion Backrest Cover 650mm - Bumblebee Yellow Suitable for Wing 1, Fin 1 and Cape 1
 MBKCOV06_AV	Motion Backrest Cover 650mm - Avocado Green Suitable for Wing 1, Fin 1 and Cape 1
 MBKCOV06_SO	Motion Backrest Cover 650mm - Sunset Orange Suitable for Wing 1, Fin 1 and Cape 1
 MBKCOV06_CR	Motion Backrest Cover 650mm - Chilli Red Suitable for Wing 1, Fin 1 and Cape 1



Backrest Covers

Please specify your chosen colour at time of original order. Additional charges will apply for fabric covers ordered after original supply. For code and colour options see below.

STOCK CODE	DESCRIPTION
 MBKCOV14_AS	Motion Backrest Cover 1400mm - Ash Grey Suitable for Meeting, Wing 2, Fin 2, Cape 2 and Canopy
 MBKCOV14_ST	Motion Backrest Cover 1400mm - Stone Grey Suitable for Meeting, Wing 2, Fin 2, Cape 2 and Canopy
 MBKCOV14_CL	Motion Backrest Cover 1400mm - Charcoal Grey Suitable for Meeting, Wing 2, Fin 2, Cape 2 and Canopy
 MBKCOV14_DB	Motion Backrest Cover 1400mm - Deep Blue Suitable for Meeting, Wing 2, Fin 2, Cape 2 and Canopy
 MBKCOV14_IC	Motion Backrest Cover 1400mm - Ice Blue Suitable for Meeting, Wing 2, Fin 2, Cape 2 and Canopy
 MBKCOV14_EM	Motion Backrest Cover 1400mm - Emerald Green Suitable for Meeting, Wing 2, Fin 2, Cape 2 and Canopy
 MBKCOV14_BB	Motion Backrest Cover 1400mm - Bumblebee Yellow Suitable for Meeting, Wing 2, Fin 2, Cape 2 and Canopy
 MBKCOV14_AV	Motion Backrest Cover 1400mm - Avocado Green Suitable for Meeting, Wing 2, Fin 2, Cape 2 and Canopy
 MBKCOV14_SO	Motion Backrest Cover 1400mm - Sunset Orange Suitable for Meeting, Wing 2, Fin 2, Cape 2 and Canopy
 MBKCOV14_CR	Motion Backrest Cover 1400mm - Chilli Red Suitable for Meeting, Wing 2, Fin 2, Cape 2 and Canopy

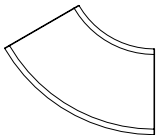

For product dimensions please refer to back of product selector

	STOCK CODE	DESCRIPTION
	MLPS7_ST	Motion Loop - Straight
	MLPC60_ST	Motion Loop - Curved 60°



**Motion Loop
Example 1**

- 1 x Motion Loop Straight
- 1 x Motion Loop Straight Back
- 2 x Motion Loop Curved 60° Outer Back
- 1 x Motion Loop Curved 60° Inner Back

CODE: MLOOPEX1_CLST

**For information on power options please contact your MotionOffice supplier.*

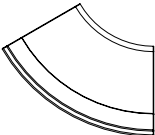
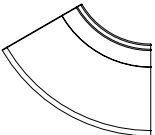
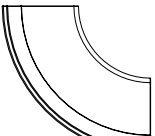

For product dimensions please refer to back of product selector

STOCK CODE	DESCRIPTION
	<p>MLPS7B_CLST Motion Loop - Straight with backrest</p>
	<p>MLPC60BO_CLST Motion Loop - Curved 60° Backrest Outside</p>
	<p>MLPC60BI_CLST Motion Loop - Curved 60° Backrest Inside</p>
	<p>MLPC90BO_CLST Motion Loop - Curved 90° Backrest Outside</p>

*For information on power options please contact your MotionOffice supplier.



For product dimensions please refer to back of product selector

	STOCK CODE	DESCRIPTION	TOPS
	MST75B_LW	Motion Coffee Table - Straight Black Frame	Lacquered White
	M60TB_LW	Motion Coffee Table - Curved Black Frame	Lacquered White
	MTABB_LW	Motion Tablet Table Black Frame	Lacquered White
	MRT73B_LW	Motion Round Table - Sit Height Black Frame - 730mm high / 1050mm diameter	Lacquered White
	MRT105B_LW	Motion Round Table - Stand Height Black Frame - 1050mm high / 1050mm diameter	Lacquered White



For product dimensions please refer to back of product selector

	STOCK CODE	DESCRIPTION	TOPS
	MST75B_BE	Motion Coffee Table - Straight Black Frame	Solid Beech
	M60TB_BE	Motion Coffee Table - Curved Black Frame	Solid Beech
	MTABB_BE	Motion Tablet Table Black Frame	Solid Beech
	MRT73B_BE	Motion Round Table - Sit Height Black Frame - 730mm high / 1050mm diameter	Solid Beech
	MRT105B_BE	Motion Round Table - Stand Height Black Frame - 1050mm high / 1050mm diameter	Solid Beech

Luna Chair > Seating



Luna Chair Castor Base



Luna Chair Oak Base



STOCK CODE	DESCRIPTION	TYPE
LUNAB_CAS_#	Luna Black Chair with Castor Base Upholstered cushion	Seating
LUNAW_CAS_#	Luna White Chair with Castor Base Upholstered cushion	Seating
LUNAB_OAK_#	Luna Black Chair with Oak Base Upholstered cushion	Seating
LUNAW_OAK_#	Luna White Chair with Oak Base Upholstered cushion	Seating

= Please specify the code of your chosen cushion colour when ordering.

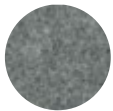

Ash Grey
#= AS



Stone Grey
#= ST



Charcoal Grey
#= CL

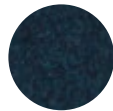

Deep Blue
#= DB

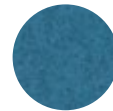

Ice Blue
#= IC



Black PU
#= BPU



Emerald Green
#= EM



Bumblebee Yellow
#= BB



Avocado Green
#= AV



Sunset Orange
#= SO



Chilli Red
#= CR



White PU
#= WPU

Luna Barstool > Seating



Luna Barstool Oak Base

STOCK CODE	DESCRIPTION	TYPE
LUNAB_BAR_#	Luna Black Barstool with Oak Base Upholstered cushion	Seating
LUNAW_BAR_#	Luna White Barstool with Oak Base Upholstered cushion	Seating

= Please specify the code of your chosen cushion colour when ordering.



Ash Grey
#= AS



Stone Grey
#= ST



Charcoal Grey
#= CL



Deep Blue
#= DB



Ice Blue
#= IC



Black PU
#= BPU



Emerald Green
#= EM

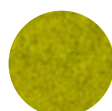

Bumblebee Yellow
#= BB



Avocado Green
#= AV



Sunset Orange
#= SO



Chilli Red
#= CR



White PU
#= WPU

Motion Sync & Free > Seating



Motion Sync Nylon Base with Seat Cover



Motion Sync Nylon Base with Arms



Free Chair Polished Alloy Base

STOCK CODE	DESCRIPTION	TYPE
MSYNCN_B_#	Motion Sync - Nylon Base Includes Motion Felt Seat Cover	Seating
MSYNC_ARM	Motion Sync Adjustable Arm (pair)	Seating
MSYNCOV_#	Motion Sync Seat Cover Motion Felt	Seating
FREE_#	Free Chair - Alloy Base Upholstered in Motion Felt	Seating

= Please specify the code of your chosen seat cover colour when ordering.



Ash Grey
#= AS



Stone Grey
#= ST



Charcoal Grey
#= CL



Deep Blue
#= DB



Ice Blue
#= IC



Emerald Green
#= EM

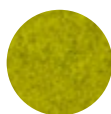

Bumblebee Yellow
#= BB



Avocado Green
#= AV



Sunset Orange
#= SO



Chilli Red
#= CR



Plant Holder

Magazine Holder

Monitor Bracket

Bag/Coat Hook

Name Plate

STOCK CODE	DESCRIPTION	TYPE
MPLANT_B	Plant Holder Black Powdercoat	Accessories
MMAG_B	Magazine Holder Black Powdercoat	Accessories
MMBRAC_B	Monitor Bracket Black Powdercoat	Accessories
MHOOK_B	Bag/Coat Hook - Pack of 3 Black Powdercoat	Accessories
MNAME_B	Name Plate Black Powdercoat	Accessories
MF##	Motion Felt Per metre	Fabric
MFROLL_##	Motion Felt Per metre/roll (50m)	Fabric



Pixel

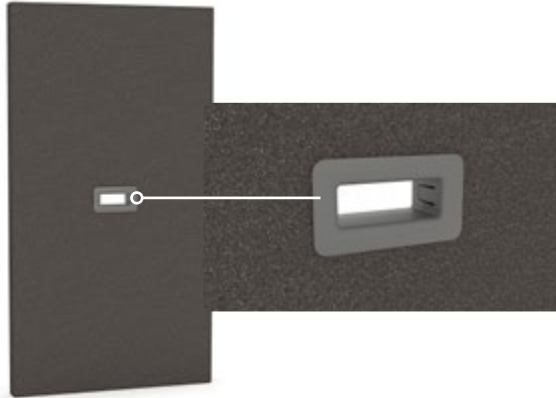

Cable Port

STOCK CODE	DESCRIPTION	TYPE
PIXEL	Pixel - Black see page 37 for pixel locations	Power & Data
MOCPORT	Motion Panel Cable Port 30 x 88mm Charcoal - Suitable for Wave, Zip and Shell	Power & Data

Base 650mm

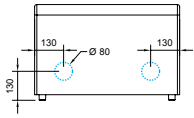

Wing 1 Fin 1 Cape 1

Base 1400mm

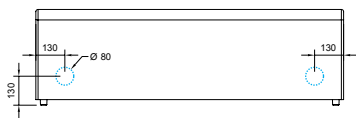

Wing 2 Fin 2 Cape 2 Canopy Meeting

Grandstand

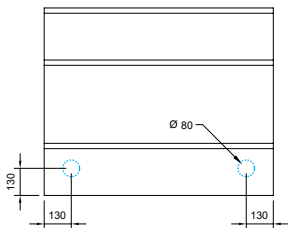

Grandstand 2 Tier Grandstand 3 Tier

Loop

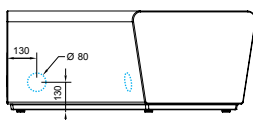

Straight 60° Straight 60° Outer



60° Inner 90° Outer

Wedge

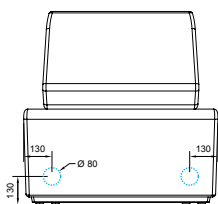

Wedge

Motion Felt > Custom

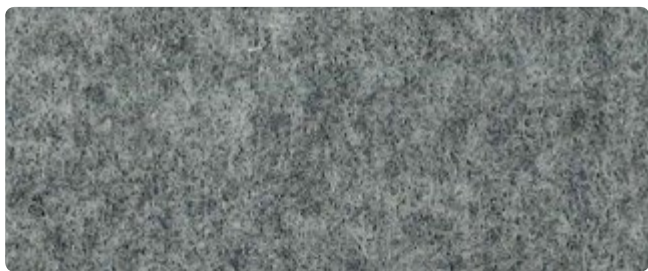

Ash Grey (MFAS)

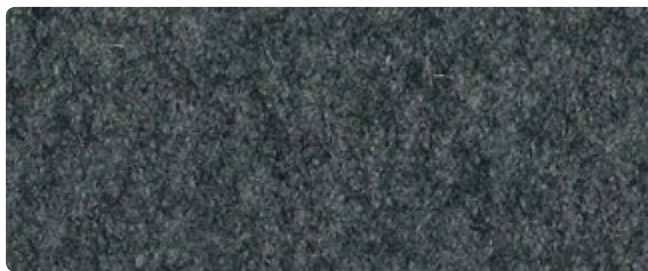

Stone Grey (MFST)

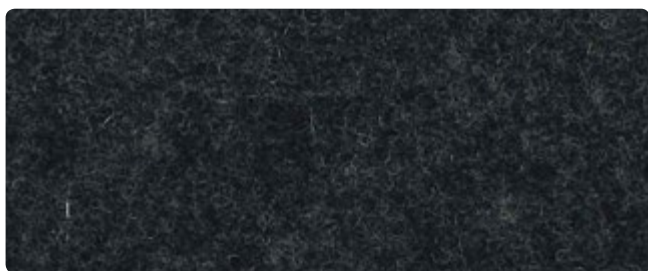

Charcoal Grey (MFCL)



Deep Blue (MFDB)

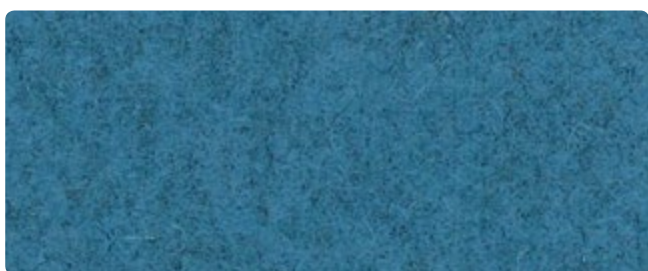

Ice Blue (MFIC)

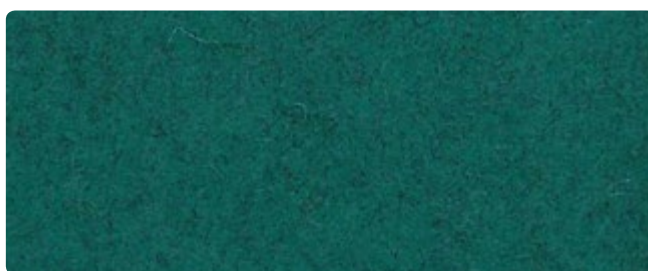

Emerald Green (MFEM)



Bumblebee Yellow (MFBB)



Avocado Green (MFAV)



Sunset Orange (MFSD)



Chilli Red (MFCD)

Motion Felt

Motion Felt can be used to upholster all MotionOffice products.

Motion Felt is a wool blend textile with a soft hand and contemporary colour-ways that will add a subtle, elegant distinction to larger, upholstered furniture items.

Motion Felt is yarn dyed and has been milled to give it a direction-less felted appearance. The milling process also increases the inherent durability and water repellent properties, which along with the natural flame resistant properties of wool, makes this fabric very suitable for heavy commercial use.

Technical Specifications

Type:	Upholstery
Composition:	50% Wool 50% Polyester
Weight:	750g/lin.m
Roll Width:	150cm
Repeat:	None
Abrasion:	100,000 rubs (Martindale)
Pilling:	4-5, BS EN ISO 12945-2:2000
Light Fastness:	4-5, BS EN ISO 105-B02
Flammability:	BS EN 1021.1 (cigarette) BS EN 1021.2 (match) CAL TB 117-2013
Colour Matching:	Batch to batch variations in colour may occur within commercial tolerances

Maintenance & Cleaning

Wool is naturally anti-static and water repellent making it less likely to attract dirt and absorb spillages. It is important to keep the fabric clean as this will extend the life of the fabric and preserve its fire retardant properties. Frequent (weekly) vacuuming on low suction is advised to remove dust and loose soiling. Under normal commercial use we recommend cleaning 1-3 times yearly by a professional dry cleaning service. It is important to protect the fabric from direct and refracted sunlight as this will ensure that the fabric retains its original colour.

Spot Cleaning

Soiling should be acted on immediately to prevent lasting damage to the fabric. We always recommend testing stain removal detergents and solvents on an inconspicuous area first.

- Immediately absorb any liquids with an absorbent cloth.
- Scrape off any solidified material with a spoon.
- Remove loose material with a vacuum cleaner on low power.
- Wipe clean with a damp cloth using pH-neutral upholstery shampoo (follow directions on packaging). Do not scrub or use a stiff brush.

- Use clean water without any cleaning product for the final clean.
- Do not use dish washing or laundry detergents. Do not use detergents, bleach, ammonia or soap intended for hard surfaces.
- Dry with a clean white cloth using a circular dabbing motion to avoid edge marks. Use of hair dryer may also help avoid edge marks.
- Allow to dry thoroughly before reusing.

This is intended as a guide only. We recommend consultation with a fabric care professional.

Environmental

As a caring, corporate citizen, we support the responsible stewardship of the earth, its inhabitants and its resources.

Our fabrics are designed and made to last, and in their manufacture, use and disposal, embody the environmental principles of Reduce, Reuse & Recycle.

Fire retardants are bromide free.

Dyes are free from heavy metals.



MO5-631



MO5-629



MO5-613

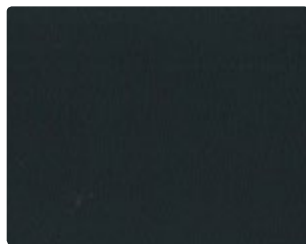

MO5-601



MO5-602

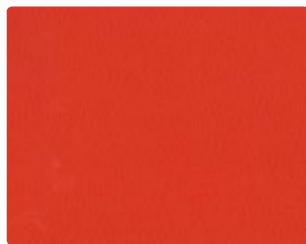

MO5-604



MO5-614

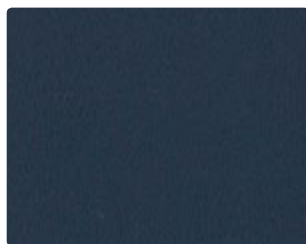

MO5-616



MO5-612



MO5-620

Eurotex PU

Eurotex PU can be used to upholster MotionOffice seat and seat backs on custom orders only.

Technical Specifications

Non-Phthalate

(PHTHALATE FREE) CPSIA 2008 Section 108, HR4040

General Requirements

- Abrasion Resistance 100,000+ Double Rubs ASTM D 4157-07 Wyzenbeek / CFFA-1A
- Mildew Resistance ASTM G21-96 / CFFA-120
- Anti-Bacterial AATCC 147 / CFFA-300
- Anti-Microbial ASTM G21-96 / CFFA-120
- Ultra Violet Resistance 500 Hours ASTM G26-96 Method C I CFFA-2
- Weathering Resistance ASTM G153-00S Cycle, 1500 hrs (Formerly G23-99)
- Chlorine Resistance mi - TLWI-317: no significant color change or stiffening
- Cold Crack - 30°C Federal Standard No.191 A-Method 5874 / CFFA-6
- Stain Resistance with Resilience Protection

Flammability Requirements

California Fire Code Technical Bulletin No. 117, Section E
 MVSS 302
 NFPA 260
 BS5852.1
 IMO A.652 (16) 8.2
 UFACCLASS 1
 ASINZS 1530.3
 CPAI-84 A

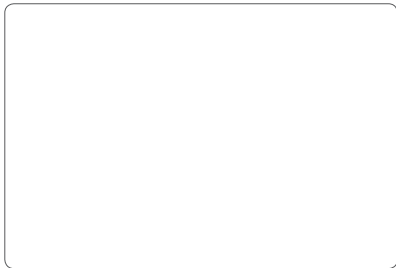

White Lacquer



Solid Beech

Features:

- Solid, commercial-grade 25mm worksurfaces
- T-nuts to fix worksurfaces and table tops
- Standard shark-nose edge finish
- Scalloped worksurfaces for cable management

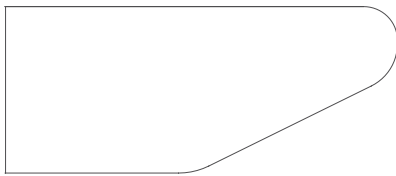

Shark-nose Edge



Shark-nose Edge

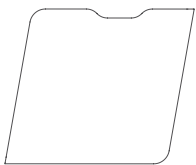

Cable Scallop - Wave

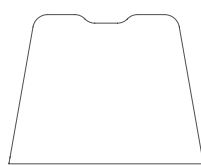

Cable Scallop - Zip

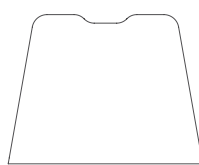

Cable Scallop - Shell

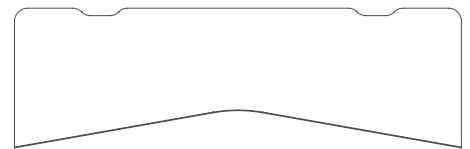

Cable Scallop - Team

Table Frames



Black Powdercoat

Features:

- Durable powdercoated steel frames

Dimensions

Motion Wave

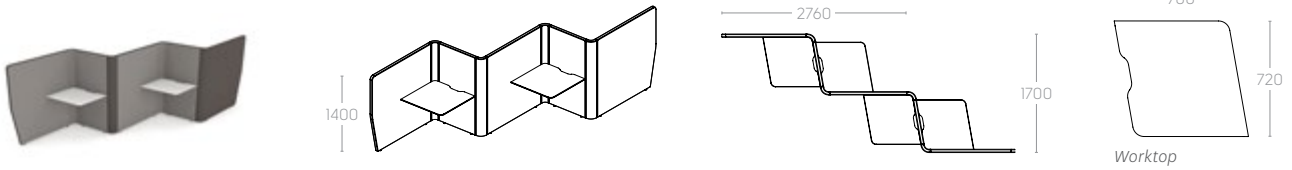

Motion Zip

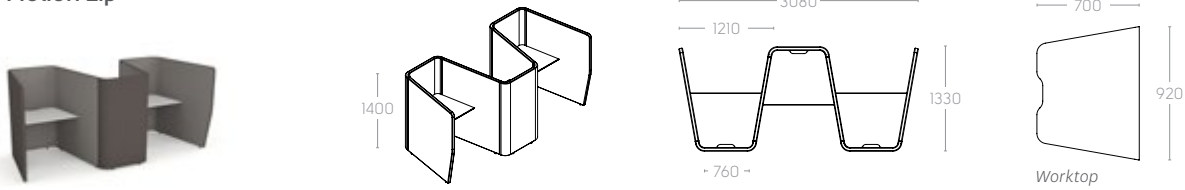

Motion Shell

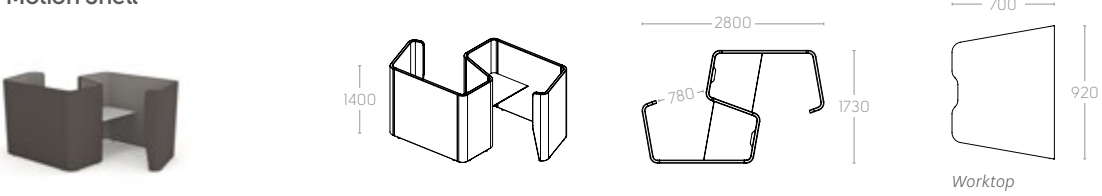

Motion Wedge

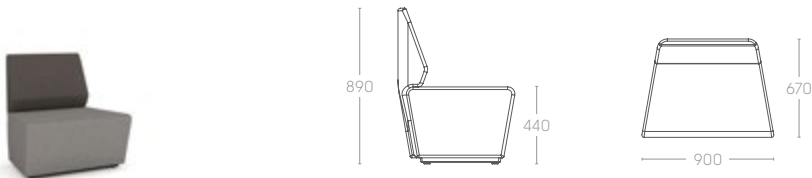

Motion Team

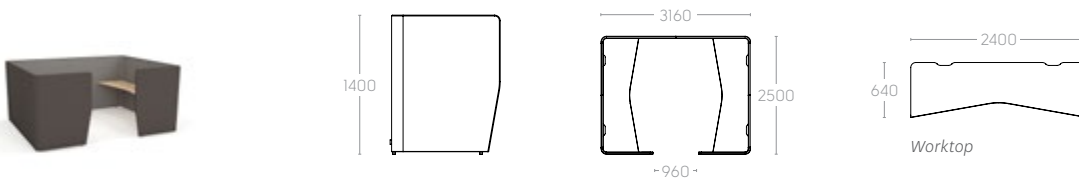

Motion Meeting

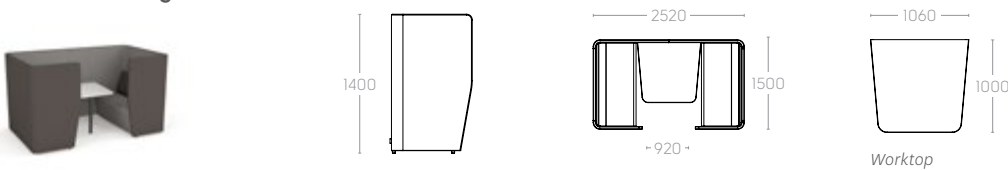

Motion Link Freestanding

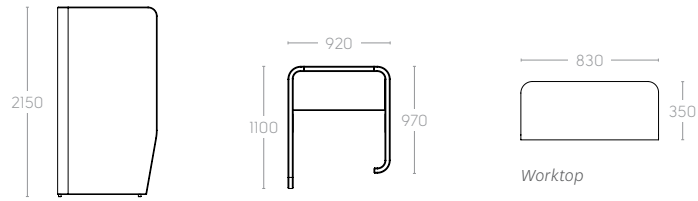

Motion Link Wall Mounted

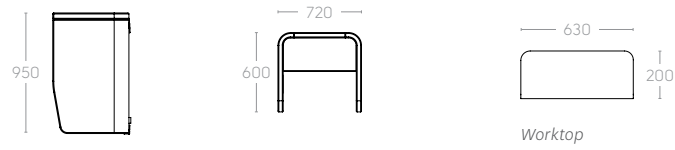

Motion Wing

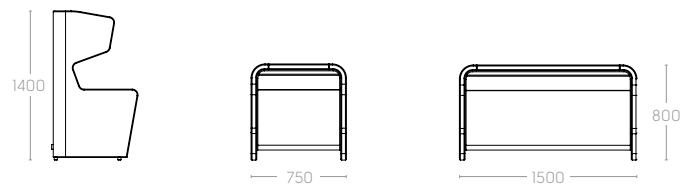

Motion Fin

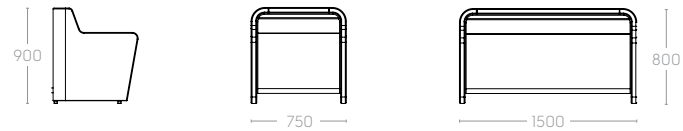

Motion Cape

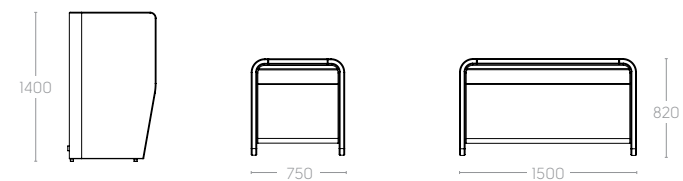

Motion Canopy

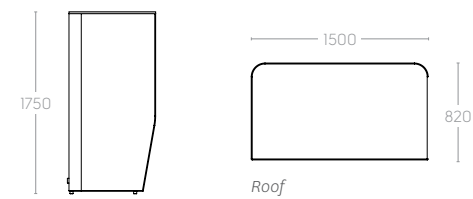

Dimensions

Motion Grandstand

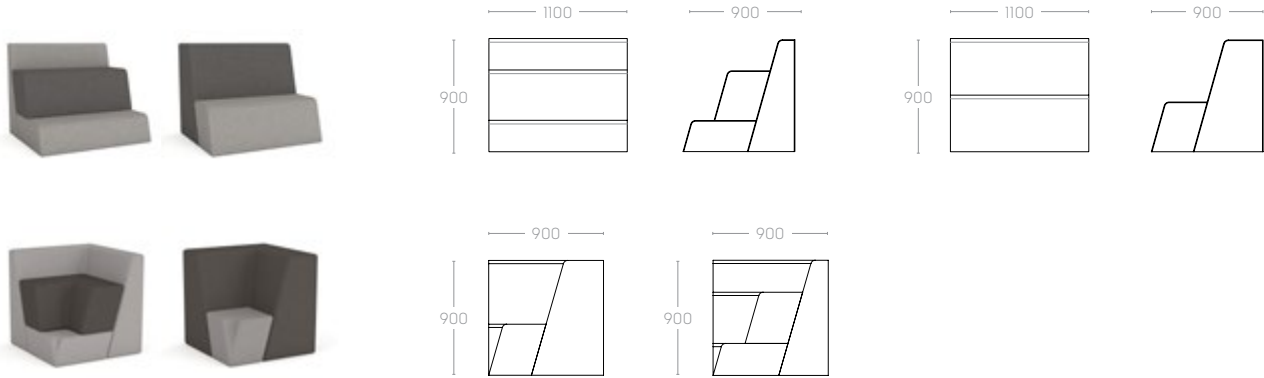

Motion Grandstand Example 1

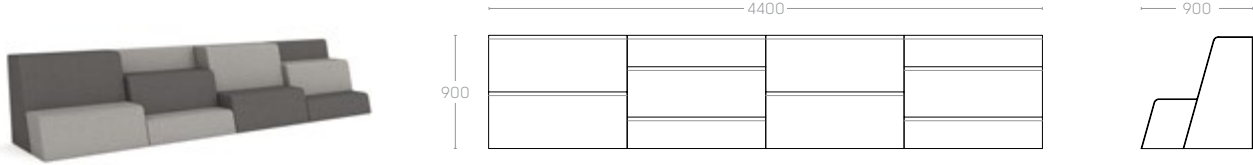

Motion Arc



Motion Arc Worksurface



Worktop Depth: 350mm Available for 1100mm high walls only.

Motion Expo

Worktop Depth: 350mm

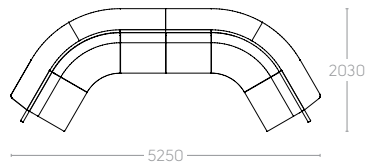

Motion Ring

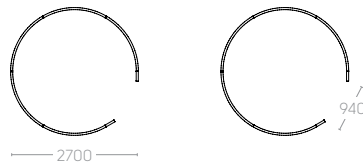

Motion Loop



Straight

60°

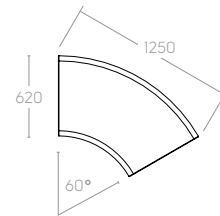
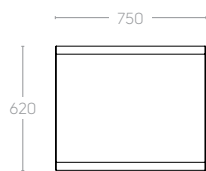

Motion Loop with Backrest



Straight

60° Outer

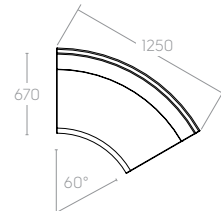
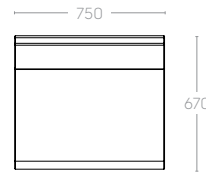
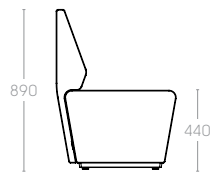

60° Inner

90° Outer

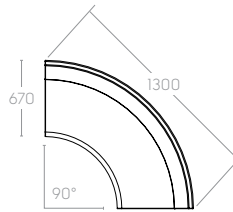
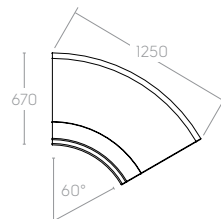

Motion Loop Example 1

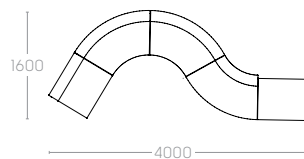

Dimensions

Motion Disc

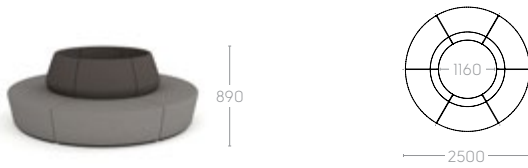

Motion Otto

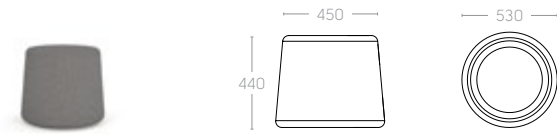

Motion Coffee Table Straight

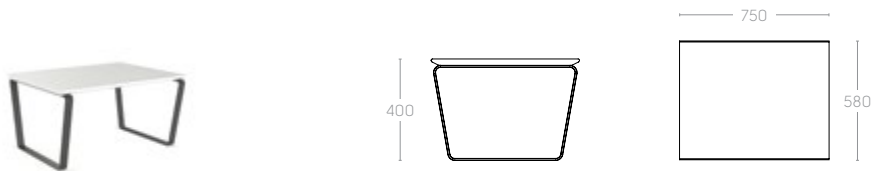

Motion Coffee Table Curved

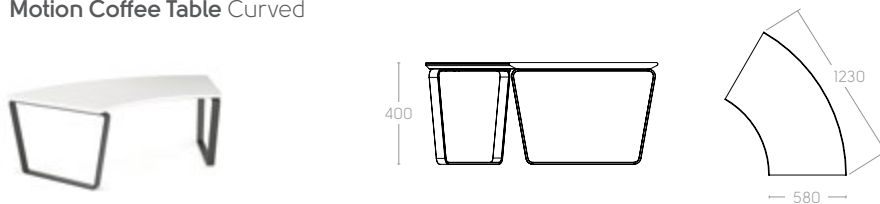

Motion Tablet Tablet

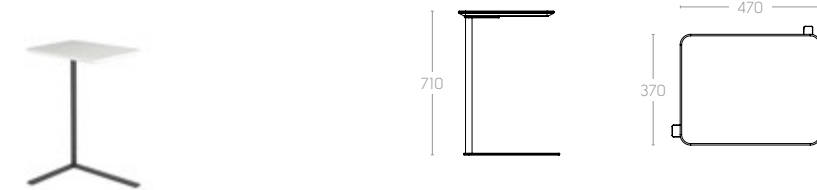

Motion Round Table

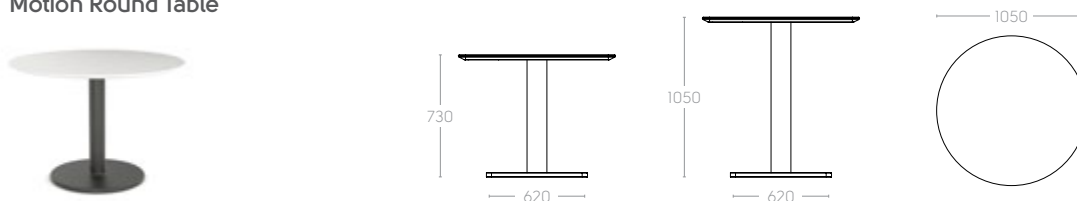

motionoffice®

PRODUCT CONFIGURATOR

Visit us online at motionoffice.com to see all your custom colour and finish options.

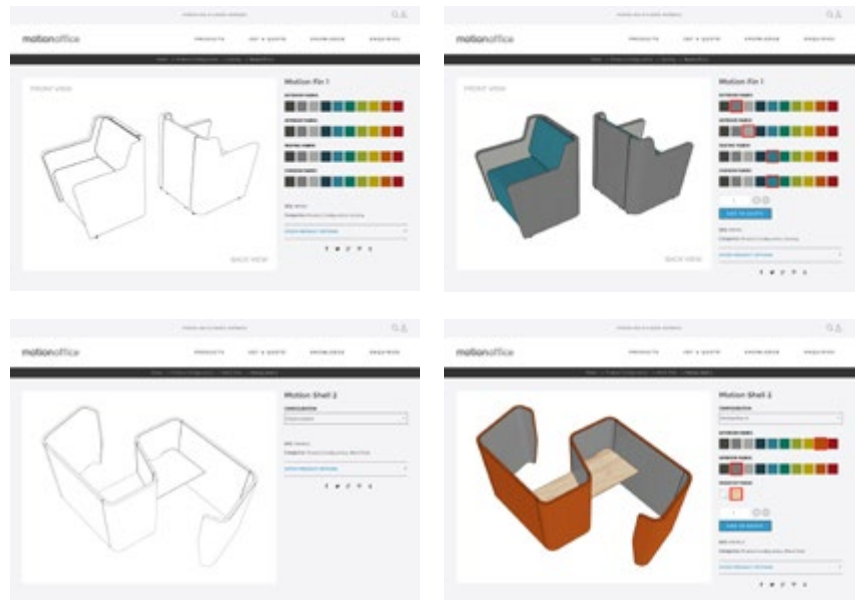

motionoffice®

VISUALISE YOUR SPACE

MotionOffice® offers fitout and 3D render services or request our latest SketchUp / dwg files to create your own fitouts, for more info email info@motionoffice.com



motionoffice®

Supplier Specialist:

OLG

info@olgoffice.com

olgoffice.com

a better way to a better workplace

motionoffice.com