













Assembly Instructions
MODEL NO. : OMJ-FC
 STATIONERY CABINET (FULL DOORS)

A  Cam Lock 29Pcs+1Pc (spare)	B  Klix Cam 29Pcs+1Pc (spare)	C  Cam Cover 29Pcs+1Pc (spare)	D  Bowel 14Pcs+1Pc (spare)	E  Center door Hinge 8Set	F  Shelf Bowel 12Pcs+1Pc (spare)	G  90mm Metal scallop shape 25Set	H  Lock 1Set	I  screw#3.5x12 9Pcs+1Pc (spare)		
J  Adjustable Glide 4 Pcs	K  Pin 1Pcs	L  screw#4x19 4Pcs+1Pc (spare)								

STEP1

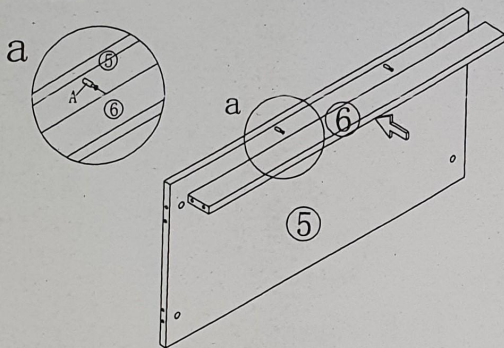

STEP2

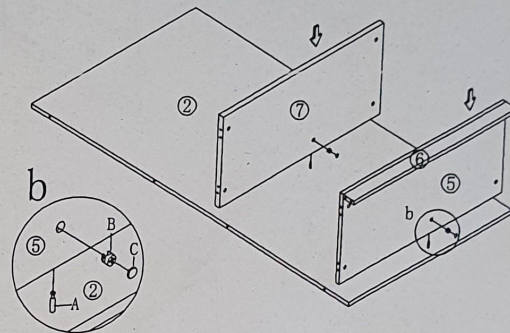

STEP3

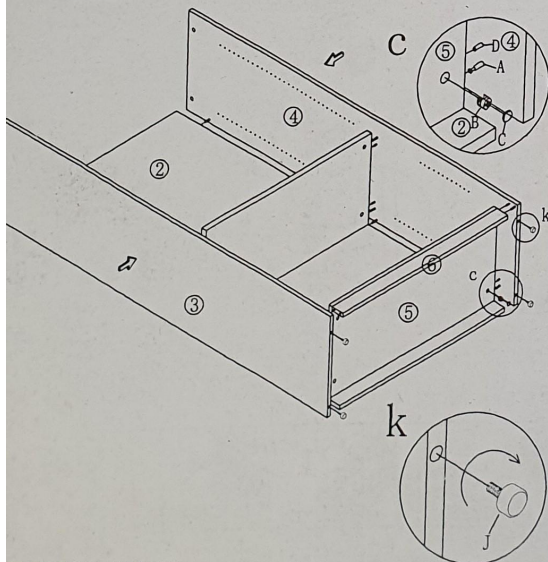

IMPORTANT:
FUNCTION OF KLIX CAM

 1/4 RIGHT
 TURN FOR
 LOCKING
 MAKE SURE THE ARROW IS
 POINTING UPWARDS BEFORE
 INSERTING INTO THE
 PANELS HOLE

IMPORTANT NOTE:

Place all laminated parts on a clean and smooth surface such as a rug or carpet to avoid the parts from being scratched.

Check to be sure that you have all parts and hardware.

Remove all wrapping materials, including staples & packing straps before you start to assemble.

Don't tighten all screws/bolts until all completely assembled.

Keep all hardware parts out of reach of children

Assembly Instructions
MODEL NO. : OMJ-FC
 STATIONERY CABINET (FULL DOORS)

STEP4

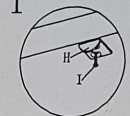
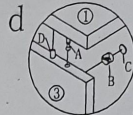
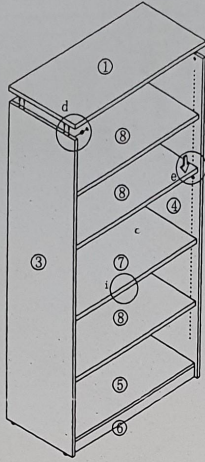

STEP5

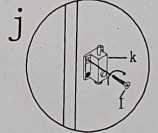
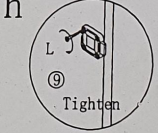
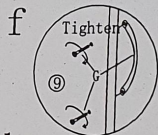
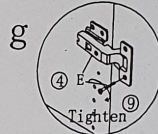
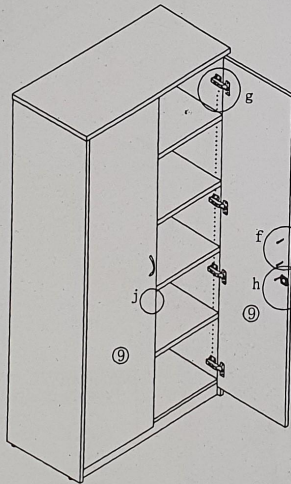

COMPLETED ASSEMBLY

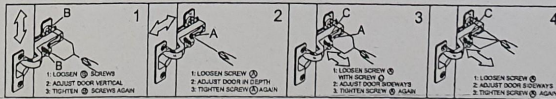

IMPORTANT NOTE:

- Place all laminated parts on a clean and smooth surface such as a rug or carpet to avoid the parts from being scratched.
- Check to be sure that you have all parts and hardware.
- Remove all wrapping materials, including staples & packing straps before you start to assemble.
- Don't tighten all screws/bolts until all completely assembled.