

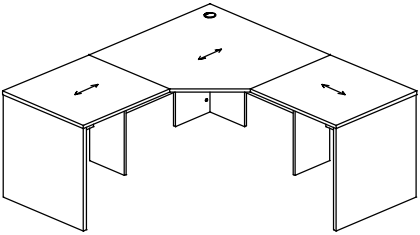

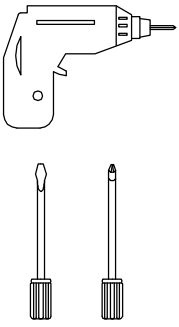





TOOLS	Connecting Parts				
	 X35	 X40	 X3		
	 X35	 X6			
	 X6	 X5			
	 X2	 X3			

OM-W315 Assembly Drawing

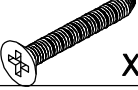

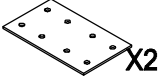
Series No.	Specification (W*D*H)	qty	Series No.	Specification (W*D*H)	qty	Series No.	Specification (W*D*H)	qty
1	900*900*25	1	6	695*300*18	1	11		
2	695*300*18	1	7	695*300*18	1	12		
3	695*320*18	1	8	600*600*25	2	13		
4	600*450*18	1	9	575*450*18	2	15		
5	600*450*18	1	10	695*594*25	2	14		

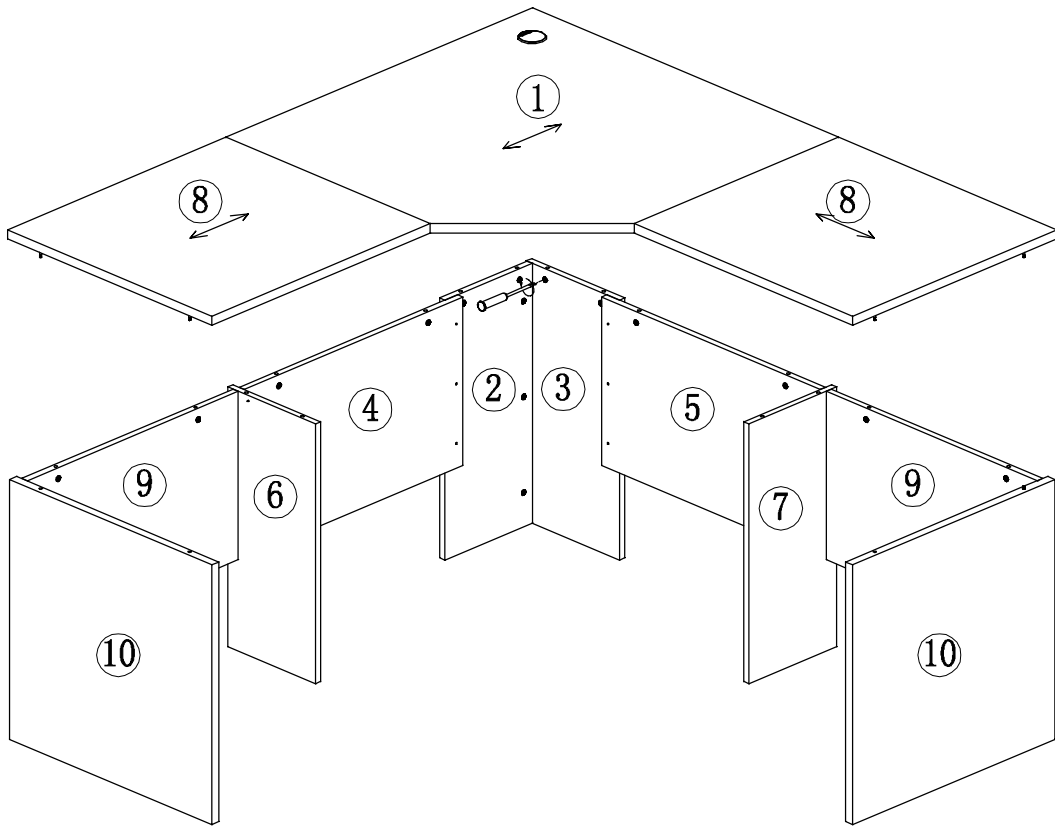
OM-W315-1
Assembly Drawing

1

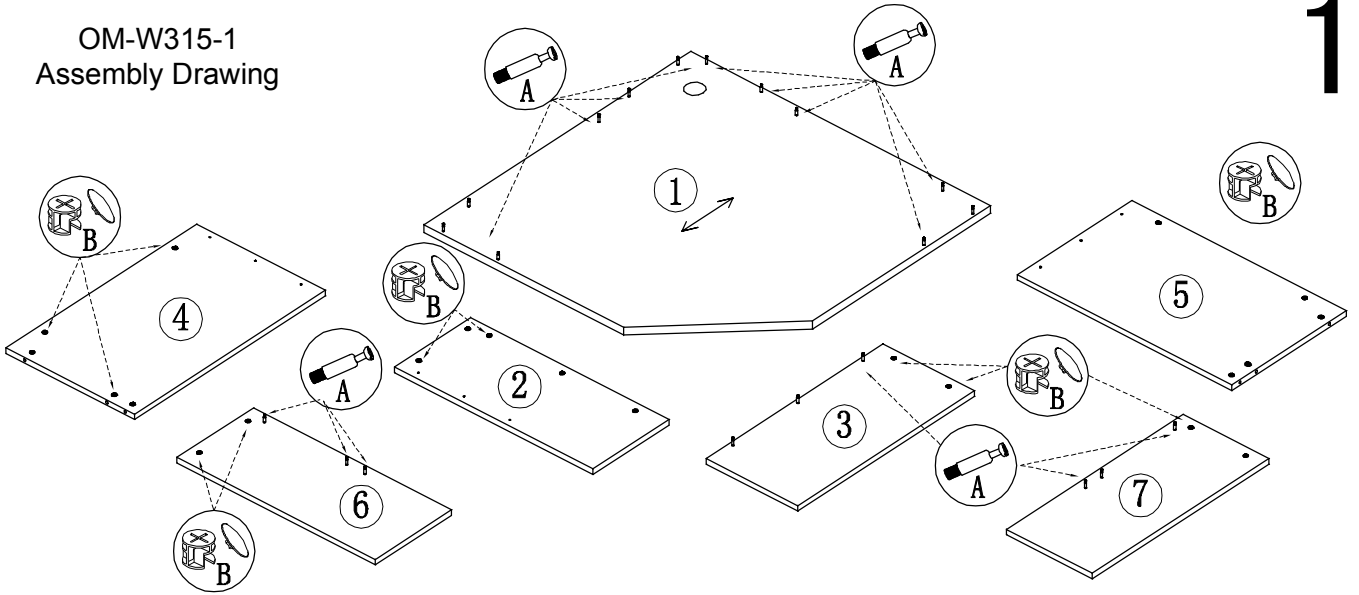

Connecting Parts

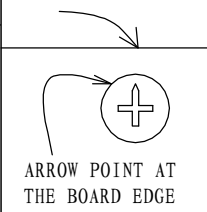
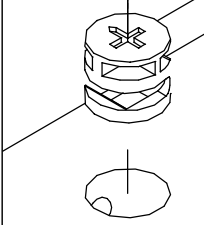
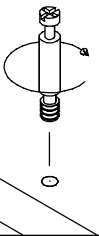
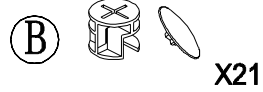

2

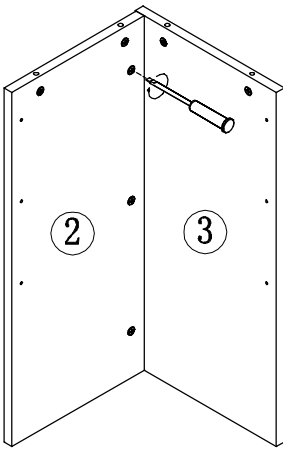

4

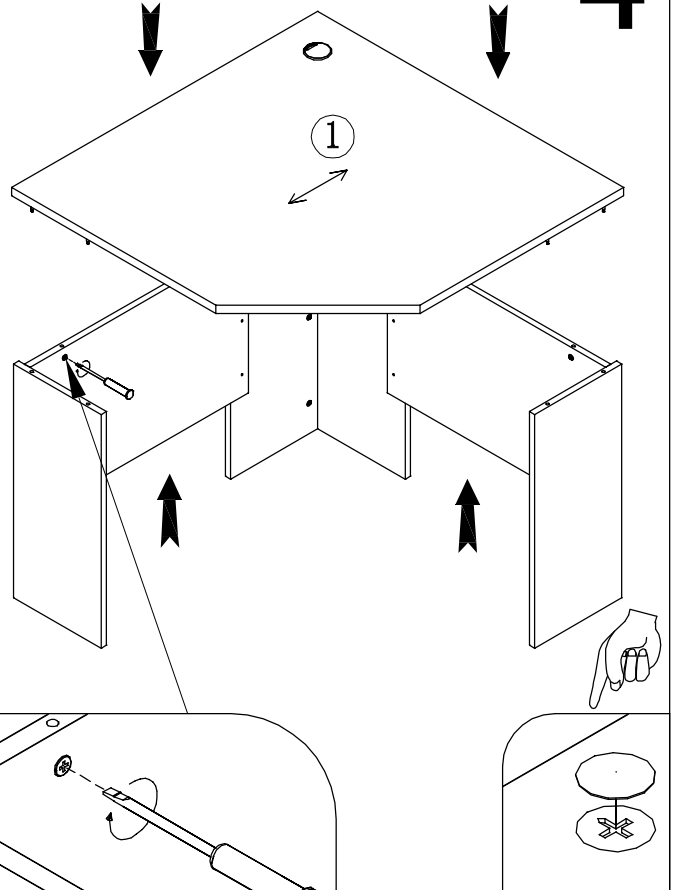

3

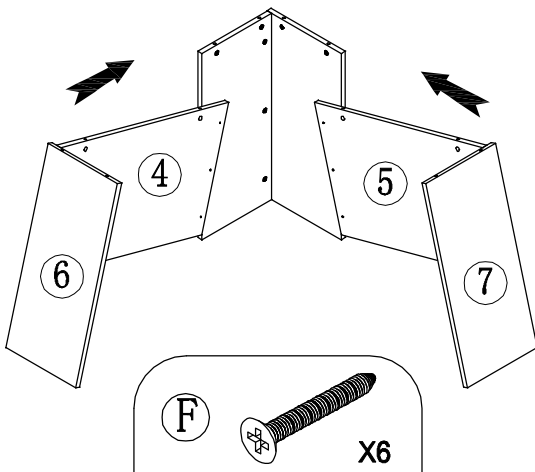

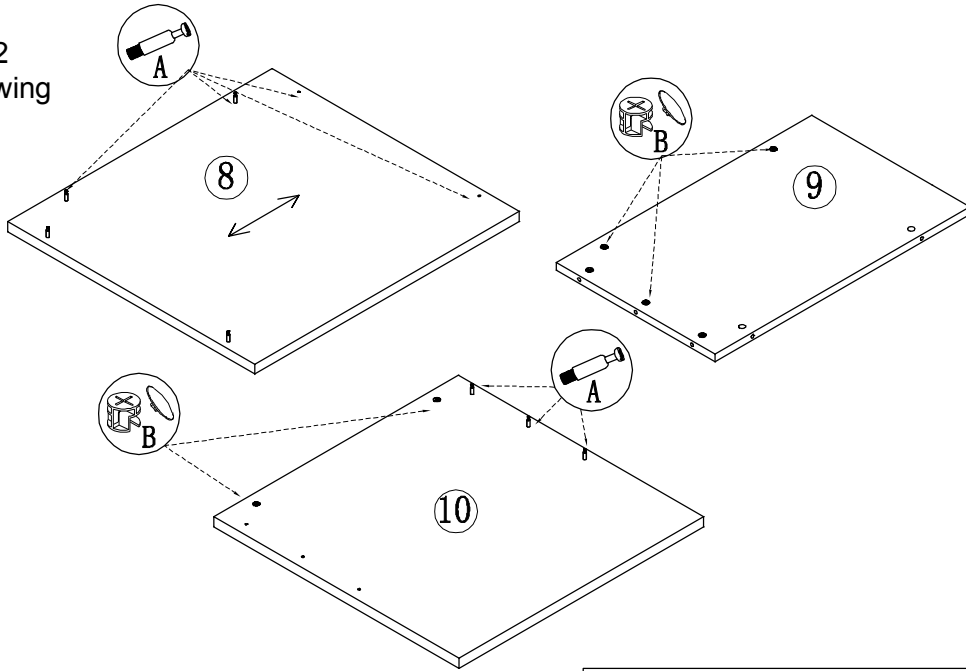

OM-W315-2
Assembly Drawing

5



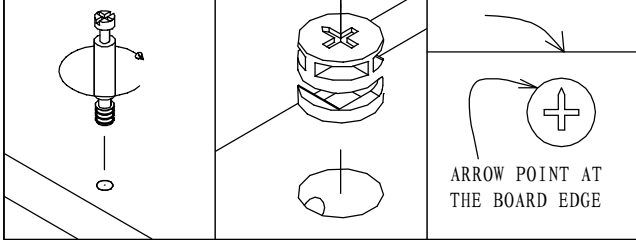



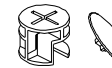

Connecting Parts

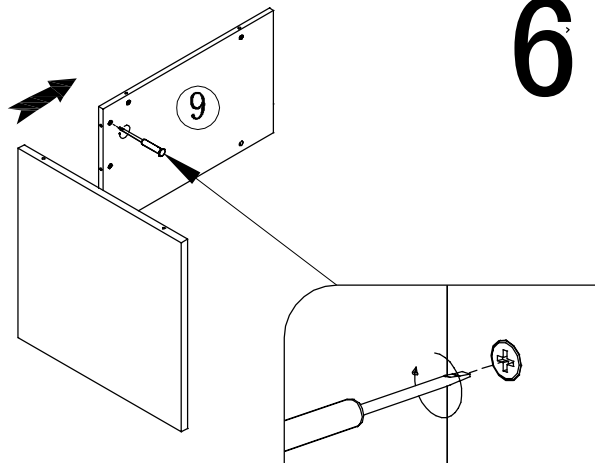

<p>(A)  X14</p>	
<p>(B)  X14</p>	

6



(C)  X6	(G)  X5
(D)  X2	(H)  X3
(E)  X40	(I)  X3

8

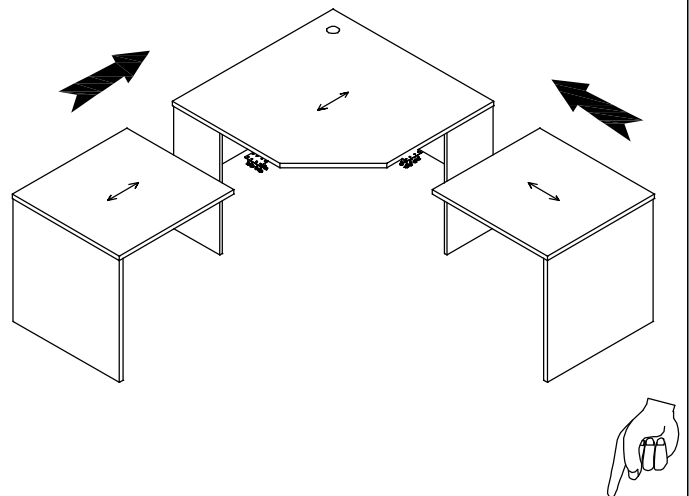

7

