

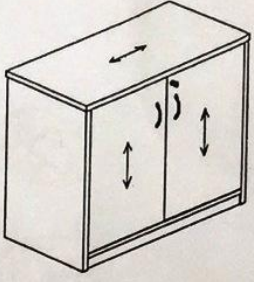

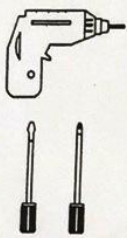



TOOLS	Connecting Parts			
	 X20	 X1	 X30	
	 X20	 X4	 X4	
	 X2	 X1		
	 X4	 X4		

OM-BH9  
Assembly Drawing



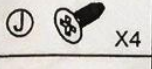
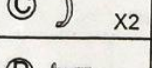
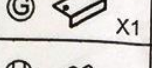
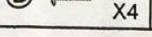
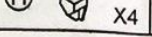
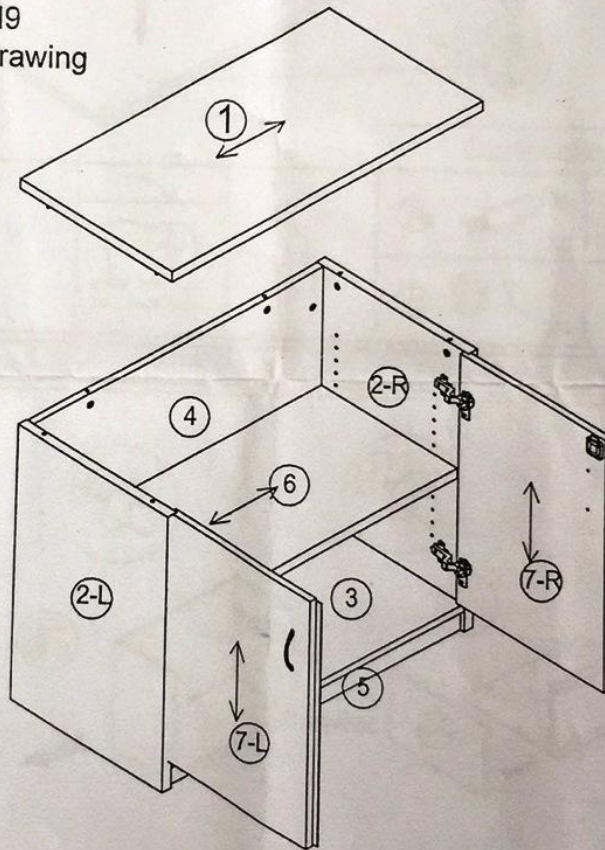
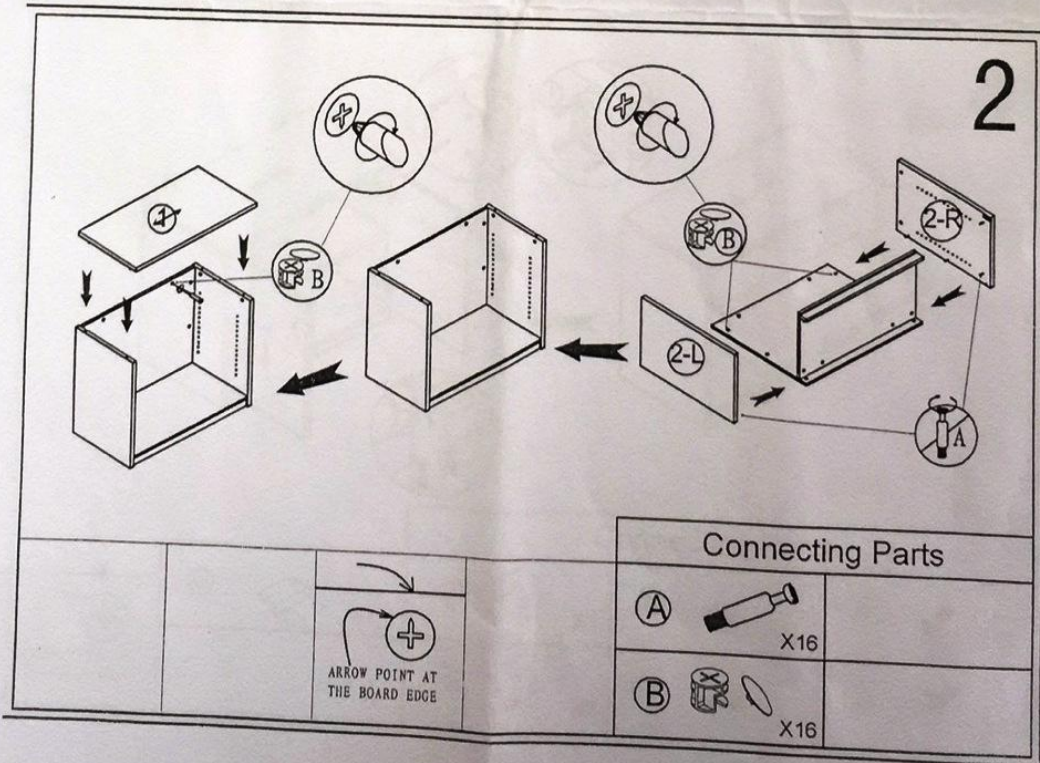
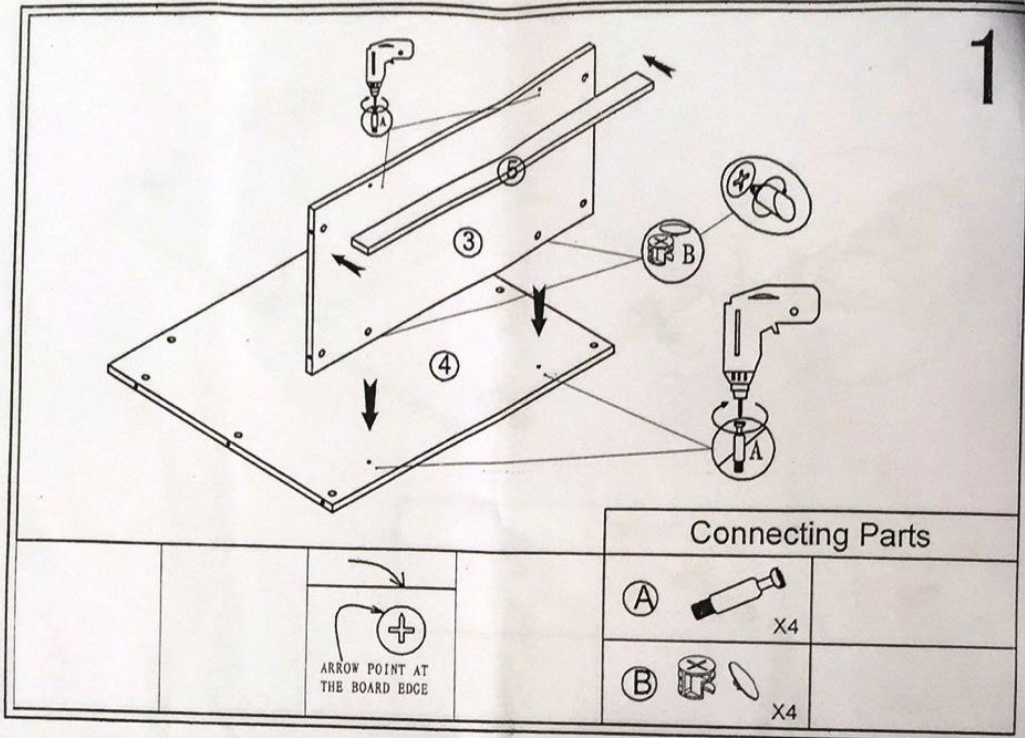

Series No.	Specification (W*D*H)	qty	Series No.	Specification (W*D*H)	qty	Series No.	Specification (W*D*H)	qty
1	900*450*25	1	5	854*50*18	1			
2-L	695*444*25	1	6	843*399*25	1			
2-R	695*444*25	1	7-L	622*420*18	1			
3	844*422*18	1	7-R	622*420*18	1			
4	695*844*18	1	8					

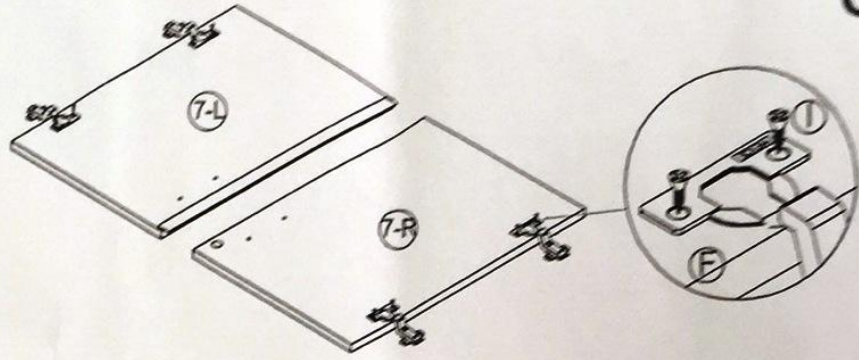

3









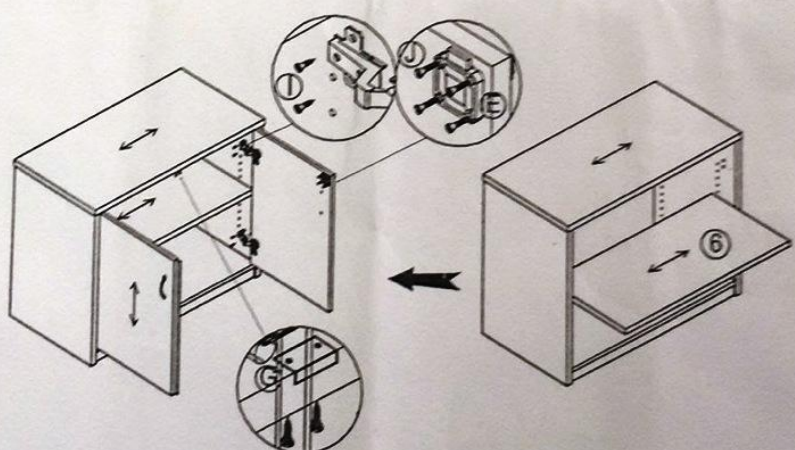

Connecting Parts

	(F)  X4	(I)  X8

4



Connecting Parts

 ARROW POINT AT THE BOARD EDGE	(G)  X1	(E)  X1	(H)  X4	(I)  X18
		(C)  X2	(D)  X4	(J)  X4