

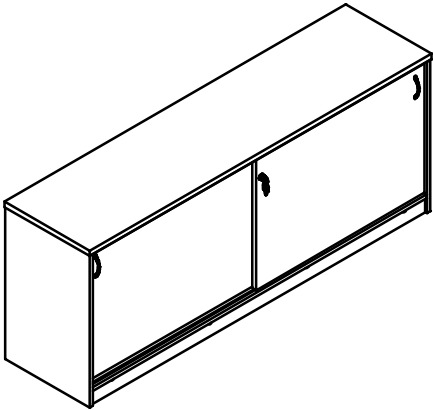

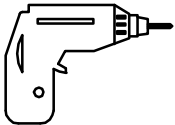



TOOLS	Connecting Parts			
	 X30	 X1		
	 X30			
	 X2	 X2		
	 X4	 X8		



OM-B15
Assembly Drawing

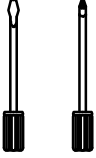

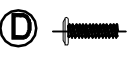
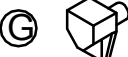
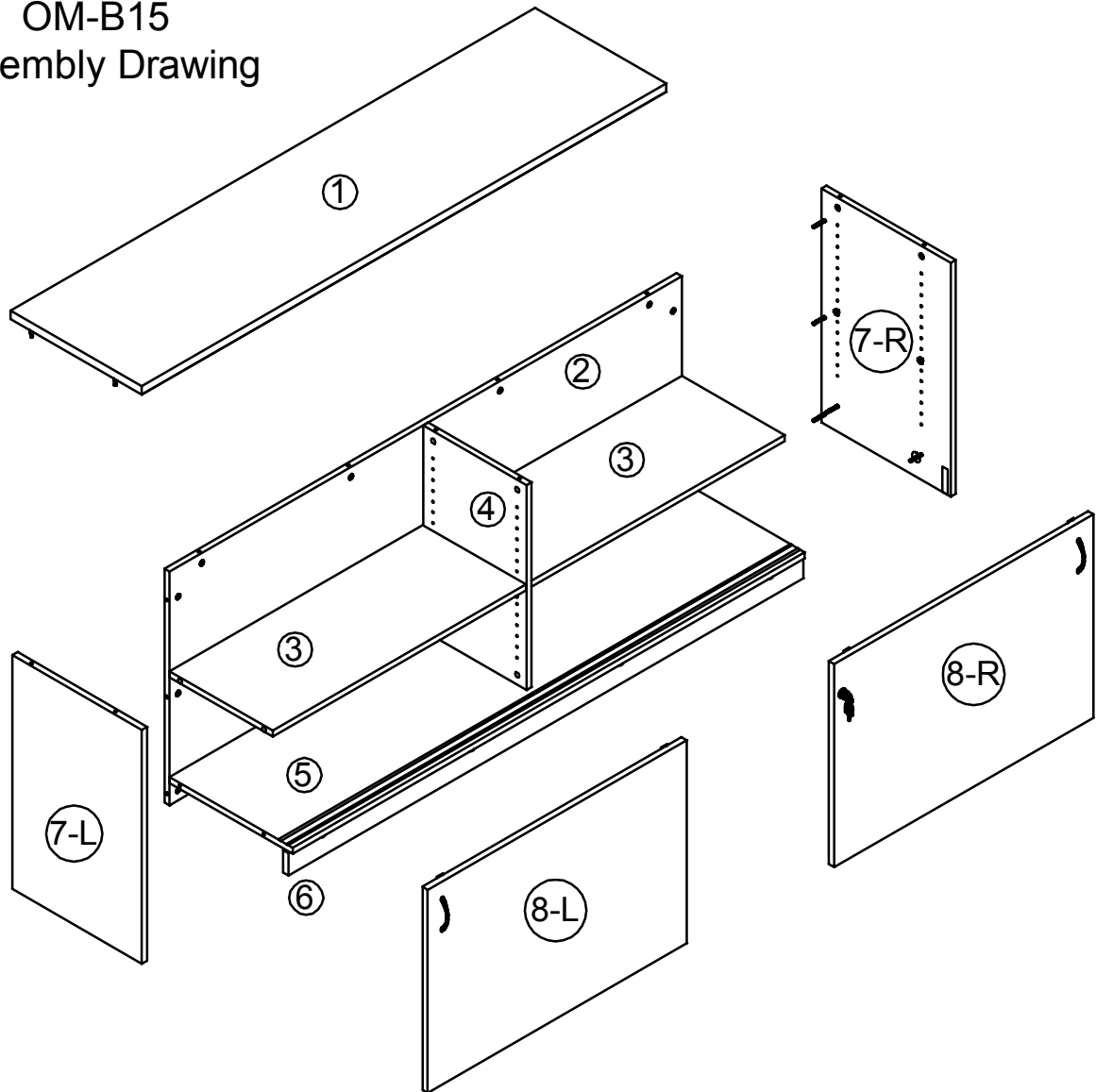
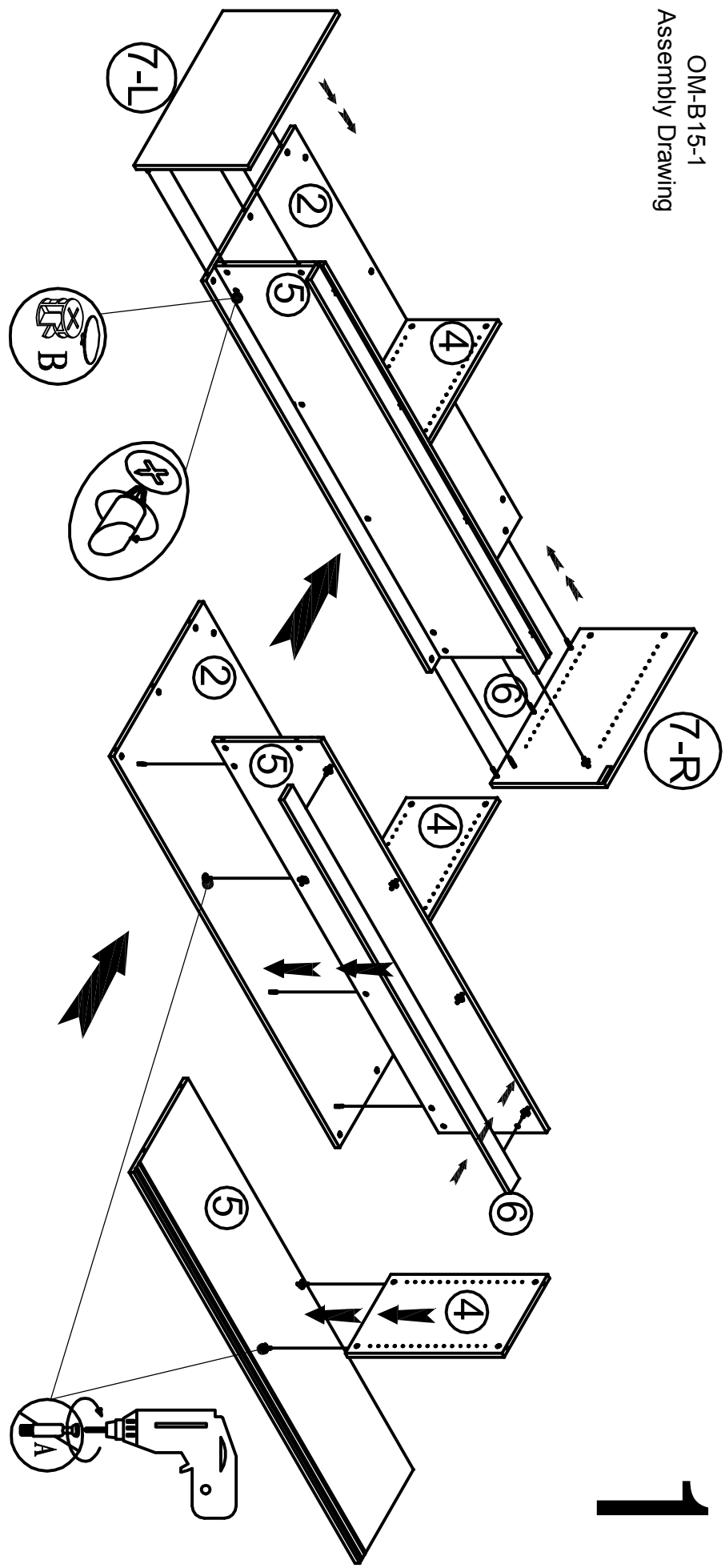
Series No.	Specification (W*D*H)	qty	Series No.	Specification (W*D*H)	qty	Series No.	Specification (W*D*H)	qty
1	1500*450*25	1	6	1454*67*18	1			
2	1444*695*18	1	7-L	695*444*25	1			
3	712*353*18	2	7-R	695*444*25	1			
4	610*355*18	1	8-L	604*732*18	1			
5	1444*422*18	1	8-R	604*732*18	1			

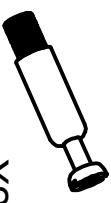

Connecting Parts



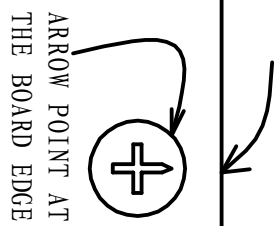

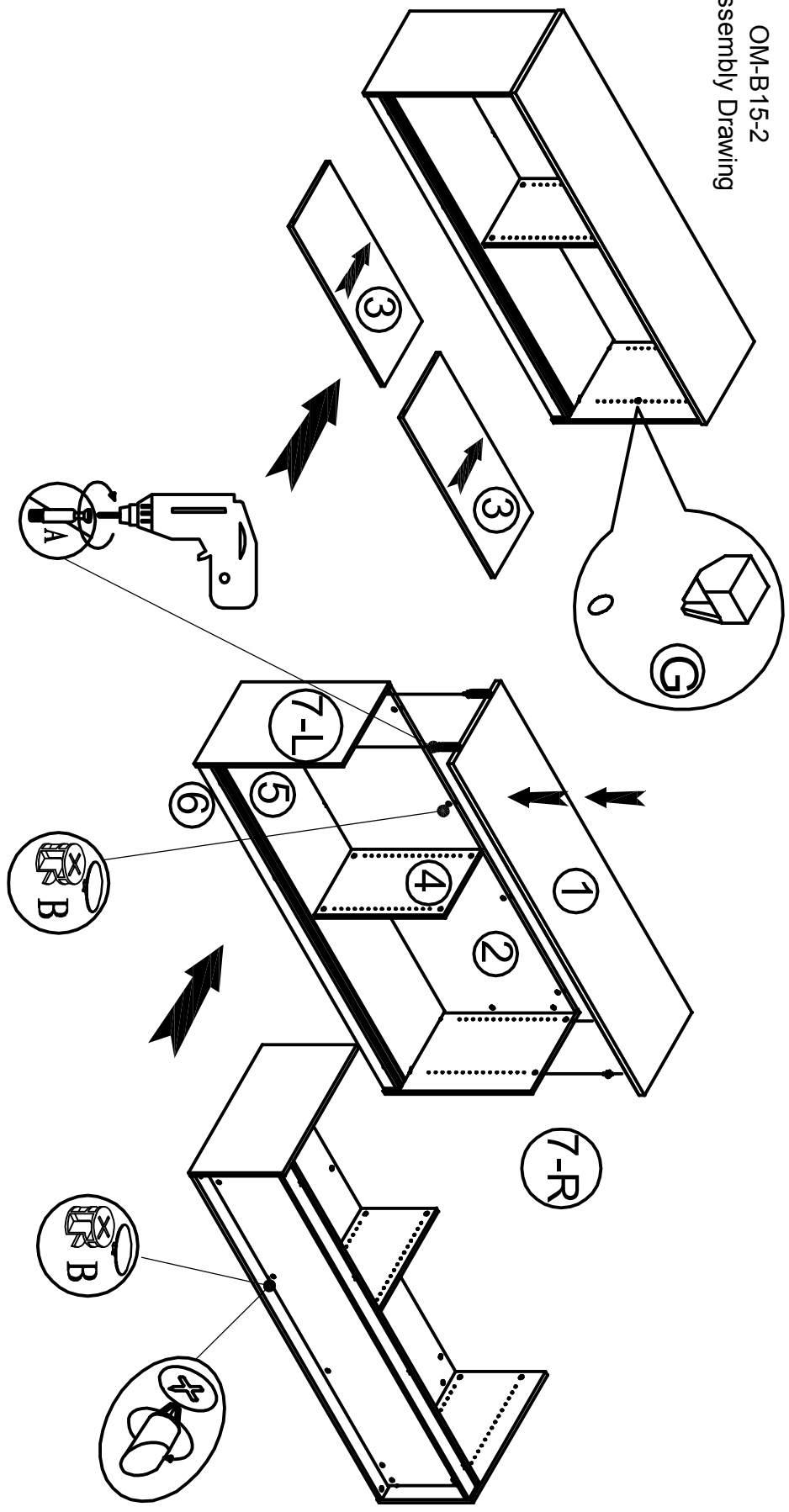
<p>(A)</p>  <p>X20</p>	
<p>(B)</p>  <p>X20</p>	





2

Connecting Parts

<p>A</p>  <p>X10</p>	<p>G</p>  <p>X8</p>
<p>B</p>   <p>X10</p>	

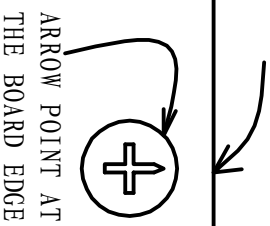

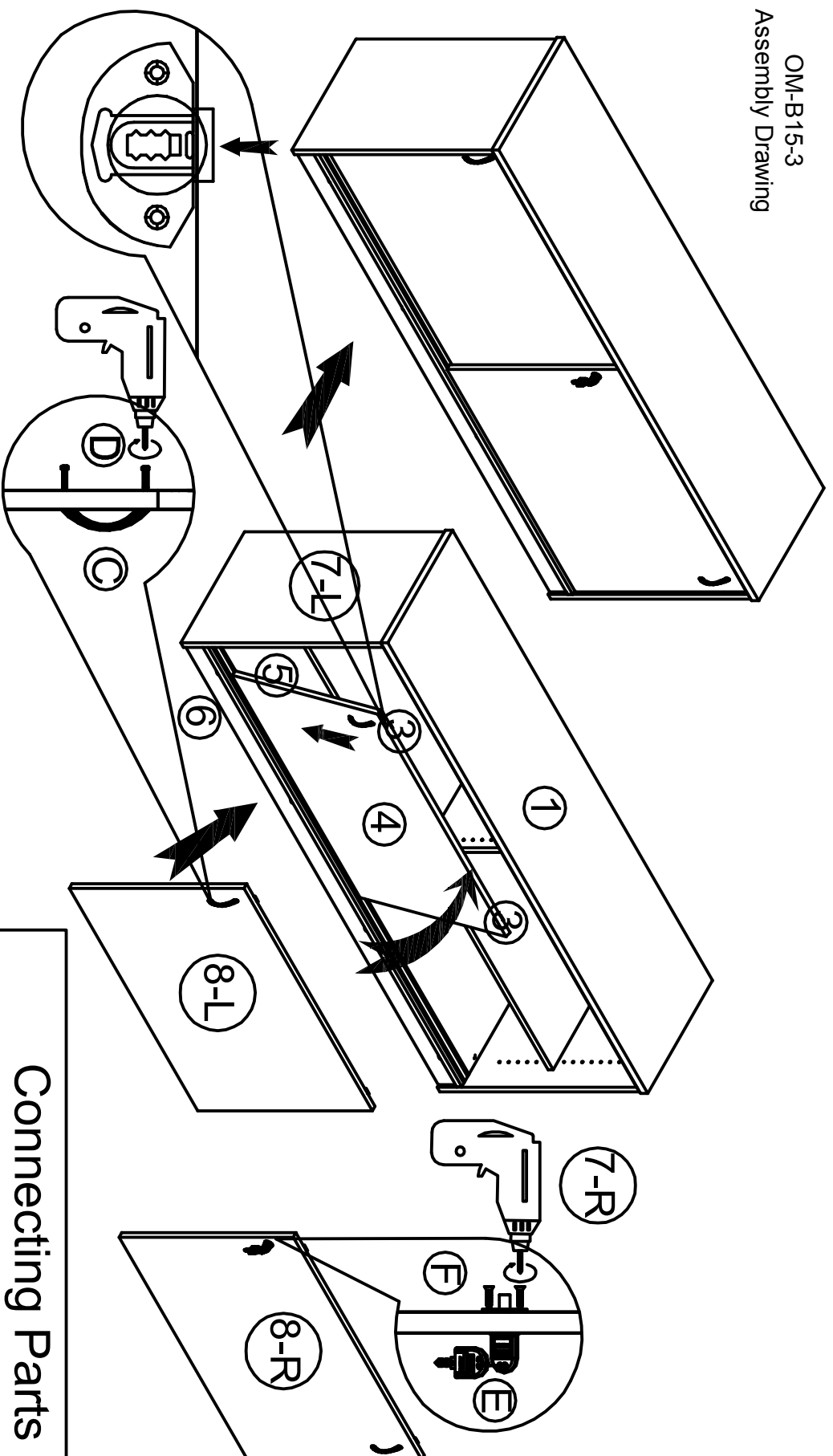

Connecting Parts

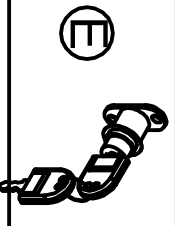
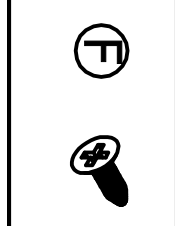
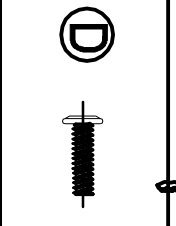
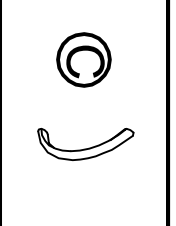
	
X1	X2
	
X4	X2

