

R4 HOSPITALITY SEATING

FOCUS



FEATURES

- » Optional arms
- » Optional left / right hand tablet arm
- » Optional black metal trolley, easy to move when stacked
- » Available in beam seating
- » Multi purpose stackable client chair
 - » Maximum 10 chairs on trolley
 - » Maximum 5 chairs on floor
 - » Maximum 3 chairs with arms
 - » Not stackable with tablet arms
- » Linkable except with tablet arms or arms
- » Fully strengthened plastic back shell
- » Fully welded frame
- » Sled chrome base
- » Available in all local fabrics
- » Optional frame or base colour (please allow 5 more days)
- » BIFMA drop tested
- » Suitable for indoor use only
- » 4 year warranty
- » Weight limit is 120kg

INDOOR USE ONLY

✗ Do not use as a step ladder



WELDED FRAME

STACKABLE

SLED BASE FRAME

Keep a permanent contact between base of chair and floor

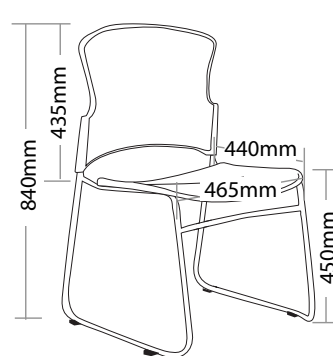

FOC-1U

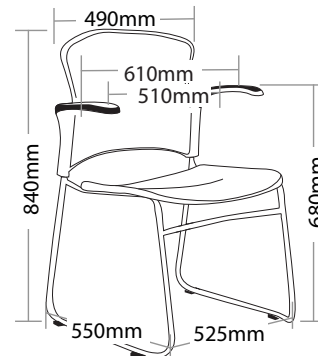

FOC-1UA

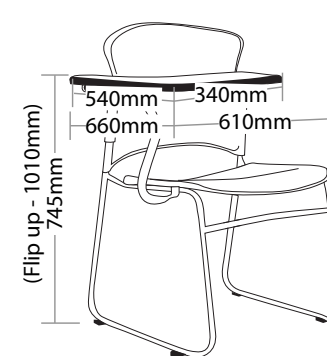

FOC-1UTR

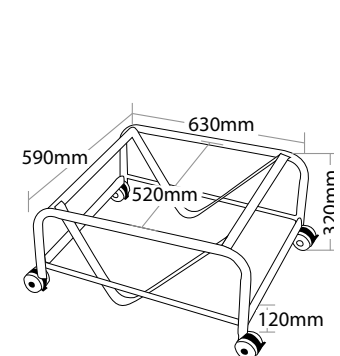

FOC-TRL

FOCUS HOSPITALITY SEATING



FOC-1U



FOC-1UA



FOC-1UTR



FOC-1UTL



FOC-TRL

