



Door Sealing Systems

Product Catalogue



Fire



Smoke



Sound



Bushfire



Energy

We are  ***Kilargo***
dormakaba Group

Table of Contents

General Information	2	Smoke Door Sealing Solutions	127
About us	2	Building Regulations & Referenced Standards	128
Kilargo Door Seals Overview	5	BCA Deemed-to-Satisfy Smoke Door Systems	132
Building Regulations & Associated Standards	6	Tested Medium Temperature Proprietary Smoke Door Systems	135
Easy Reference Icons	9	Solid Core Doors	135
Dimensioned Product Guide - Architectural Seals	10	Proprietary Fire-Rated Doors	140
Dimensioned Product Guide - Fire & Smoke Seals	12	Specialty Doors	143
Dimensioned Product Guide - Antimicrobial Seals	13		
Product Information - Architectural Door Seals	15	Fire & Smoke Door Sealing Solutions	145
1000 Series - Perimeter Seals	15	Building Regulations & Referenced Standards	146
3000 Series - Threshold (Door Bottom) Seals	23	Intumescent Fire Seals for Proprietary Fire Doors	148
4000 Series - Threshold Plates & Ramps	29	Intumescent Fire & Smoke Seals for Proprietary Fire Doors	150
5000 Series - Sweep Action Seals	39	Smoke & Acoustic Sealing Systems for Proprietary Fire Doors	152
6000 Series - Magnetic Seals	45	Solutions for Upgrading Non-compliant Proprietary Fire Doors	154
7000 Series - Perimeter Seals	49	Air Transfer / Pressure Relief Grilles for Proprietary Fire Doors	156
8000 Series - Automatic Door Bottom Seals	67		
9000 Series - Specialty Seals	81	Bushfire Sealing Solutions for Bushfire Prone Areas	157
Product Information - Fire & Smoke Seals	87	Bushfire Protection Levels & Minimum Sealing Requirements	159
Intumescent Fire & Smoke Seals	88	Bushfire Attack Level (BAL) 12.5-29	160
Flexible, Graphite Based Intumescent Fire Seals	93	Bushfire Attack Level (BAL) 40	161
T-Bar Meeting Stile Seal	97	Bushfire Attack Level (BAL) FZ	162
Bullnose Meeting Stile Seal	98		
Retrofit Intumescent Fire Door Bottom Upgrade Seals	99	Weather & Energy Door Sealing Solutions	163
Retrofit Intumescent Fire Door Perimeter Upgrade Seal	101	Building Regulations & Referenced Standards	164
Fire Door Ventilation Grilles	103	Timber & Aluminium Hinged Doors	166
		Timber, Aluminium & Glass Pivot Doors	168
Healthcare & Hygienic Environments	105	Timber, Aluminium & Glass Sliding Doors	170
Antimicrobial Door Sealing Solutions	106	Timber Bi-Fold Doors	172
		Garage Doors	173
Sound (Acoustics) Door Sealing Solutions	109	Replacement Gaskets & Seal Components	175
Building Regulations & Referenced Standards	110	Seal Gaskets	176
Solid Core Doors	112	Cover Plates & Strips	177
Proprietary Fire-Rated Doors	119	End Plates	178
Proprietary Acoustic Doors	123		

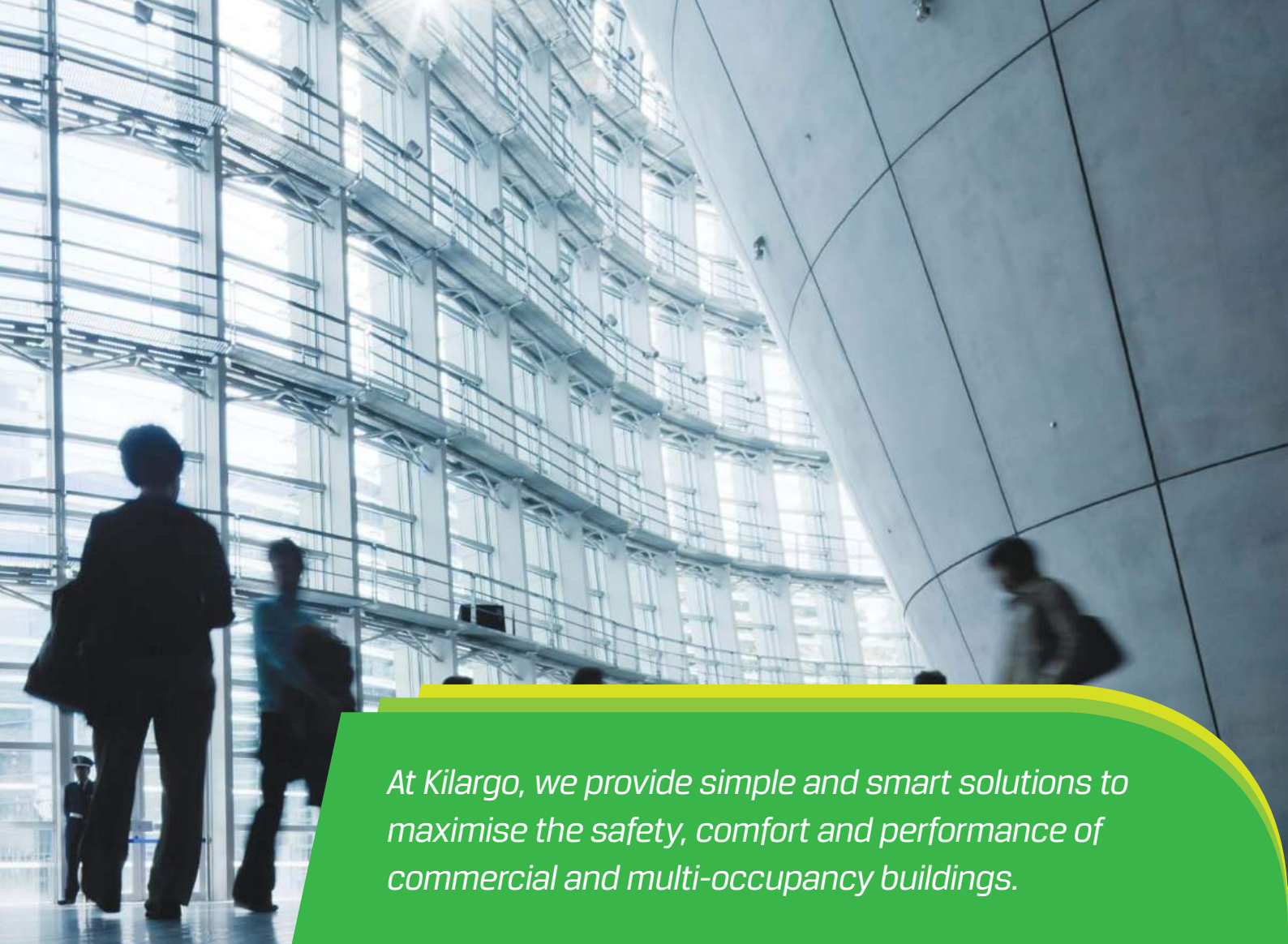

At Kilargo, we provide simple and smart solutions to maximise the safety, comfort and performance of commercial and multi-occupancy buildings.

Our innovative products are designed to contain the spread of fire, smoke and sound with many also providing weather protection and energy savings.

We deliver integrated and cost-effective systems that are ideal for any commercial building, high-rise complex, health or education facility.

Kilargo is built on a 30-year commitment to be the best. We stand proudly at the forefront of the industry, driving standards and delivering products that lead the way in design, manufacturing and quality.

We're respected experts in the principles of fire, smoke and sound. Our straight-talking approach makes it easy for clients to meet and exceed building regulations, knowing they've chosen the right system to ensure building integrity.

We know that our work can protect lives and influence reputations, so we don't just sell products. We build solid

partnerships through understanding, flexibility, seamless service and genuine enthusiasm.

Kilargo is a proud Australian manufacturer with a global presence. The vast majority of our products are manufactured and sourced in Australia, meaning fast turnaround and short lead times. We also enjoy direct links to suppliers, partners and customers throughout Europe, Asia and the Middle East.

Our products are rigorously, independently and regularly tested and all come with the Kilargo guarantee that they're backed by our passion for excellence, innovation, service, partnership, expertise and sustainability.

For us, it's about providing exceptional products for great buildings: helping you to meet regulations, protect people and property, and enhance well-being. Choosing Kilargo simply means choosing the best solution for your project, every time.

Every day, we strive to meet six key commitments – to bring you real confidence.

Excellence, Every Time

Our products perform and last. We subject every Kilargo product to tough, independent and regular testing. We have earned a reputation for exceptional quality and reliability in commercial and multi-occupancy buildings across Australia and around the world.

The Latest and Best

With Kilargo, you know you're getting the latest thinking in building safety, comfort and energy efficiency. We create, innovate and update. We are industry leaders in research and product development – and we're constantly involved in new developments internationally.

Superb Service, No Fuss

We keep our promises, tackle challenges with gusto, and deliver on time and on budget. Most of our products are manufactured and sourced domestically, meaning fast turnaround and short lead times. We pride ourselves on being technical specialists with a straight-talking approach. We make it quick and easy for you: from selection to installation.

Real Partnership

We know that our work can influence reputations and protect lives. That's why we don't sell products and walk away. We strive to truly understand our clients' needs and build enduring partnerships. That way, we see things through your eyes – so we're proactive, resourceful and always ready when you need us.

Great Team, Unbeatable Experience

With Kilargo, you get a great team that knows its stuff. We employ the best people and we're respected experts in the principles of fire, smoke and sound. We've been an internationally respected leader in the building hardware industry for more than 30 years – and we're proud to drive standards and quality further every day.

Bigger Commitment

We see the bigger picture... and our passion for the built environment extends to the natural environment. We continue to meet and exceed all relevant environmental legal requirements, reduce and manage our waste and emissions, and use resources as efficiently as possible.

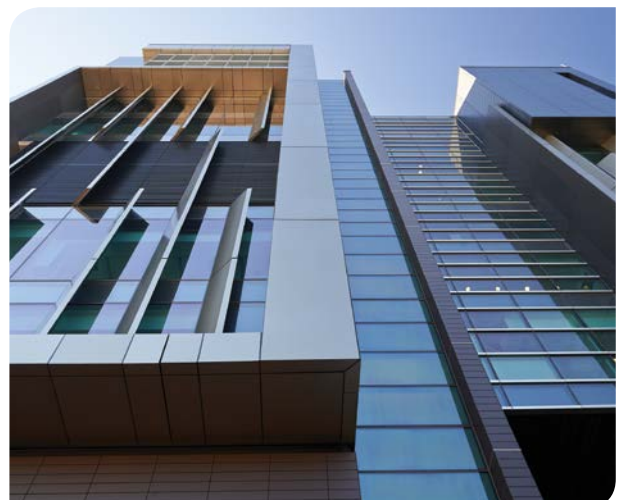



Let Us Help You Make the Right Choice

At Kilargo, we strive to truly understand our clients' needs and build enduring partnerships.

As leaders in the design and manufacture of a wide range of sealing systems, our experts are on hand to listen, help and advise. We can provide clear facts, evidence and data – as well as recommendations on how to best meet building regulations.

We also have specialised products for unusual challenges and often work with clients to develop unique solutions.

Kilargo is proud to manufacture our products locally – so we can provide quality, speed, unwavering service and real support.

Web Support

Our comprehensive website features Kilargo's extensive range of products. Our product data sheets, door sealing systems and fitting instructions can all be downloaded from the site.

Kilargo does its utmost to ensure that all technical information and recommendations given in this publication are based on factual research, backed up by a wealth of practical experience. Published data is given in good faith but we urge users to determine for themselves the suitability of the products offered, for their own particular application.

Images are not necessarily to scale, please use measurements given as a guide only. Kilargo reserves the right to alter specifications, or make obsolete any of its products, without prior notice. ©Kilargo 2018.

SteriTouch and the SteriTouch logo are registered trademarks of SteriTouch Ltd.

Kilargo Door Seals Overview

Architectural Door Seals

Professionally manufactured to exacting standards, Kilargo Architectural Seals have been developed for use in modern healthcare, commercial, industrial and public buildings.

The seals provide an exceptional, cost-effective solution for:

- **containing sound**
- **limiting the spread of fire and smoke**
- **improving energy efficiency**
- **preventing weather infiltration.**

Australian Made

Our Architectural Seals are proudly manufactured entirely in Australia.

This allows us to offer our customers:

- **outstanding quality**
- **dedicated customer support**
- **short lead times and fast turnaround**
- **customised product manufacture.**



New and Custom-Made Products

If you have a special need and can't find the right product, please call us. We pride ourselves on leading the industry in product development and innovation, and we often work with industry partners to develop customised solutions.

Trade Associations

Kilargo is a member of the Fire Protection Association Australia (FPA) and the Architectural Door Hardware Association (ADHA).



Product Warranty

Kilargo does its utmost to ensure that all technical information and recommendations are based on factual research and a wealth of practical experience. Published data is given in good faith but we urge users to decide the suitability of the products for their own particular application.

All standard products are guaranteed for two years from the date of sale, against any defects in materials or workmanship. They will be replaced without charge in any such case, provided our recommendations have been followed and the seals have been fitted according to the relevant published instructions.

Kilargo door seals are supplied as per our standard product range in "completed goods form". This is to ensure your product warranty against defects in materials or workmanship is maintained.

The Kilargo product warranty is negated when any of our products are disassembled, painted, powder coated, or changed from the original condition of supply. Since the actual fitting of the seals and the conditions of service are beyond our control, no liability can be accepted beyond the above commitment to replace defective goods.

Kilargo reserves the right to alter the specification, published data, or make obsolete any of its products, without prior notice.

Prices and Conditions of Sale

A price list for all Kilargo's products is available on request. Kilargo's commitment to innovation means that the products supplied may differ slightly from those described in this brochure.

All products are sold subject to Kilargo's terms and conditions of sale which are available upon request.



Building Regulations and Associated Standards

Outline

Building Regulations exist to ensure the safety and comfort of building users. In Australia's States and Territories this is regulated through the provisions outlined in the National Construction Code (the NCC).

The National Construction Code Series (NCC) is an initiative of the Council of Australian Governments developed to incorporate all on-site construction requirements into a single code. The Building Code of Australia (BCA) pertains to Volumes 1 & 2 of the NCC suite.

The BCA covers various areas across both commercial and residential Classes of buildings that directly relate to the Kilargo range of door seals, including:

- acoustic insulation and the containment of sound
- fire resistance
- smoke control
- bushfire risk
- weather exclusion
- conservation of energy
- accessibility and mobility.

Acoustics

The BCA regulates minimum acceptable acoustic requirements for buildings in Section F. Part F5.5.b requires a door assembly in a Class 2, Class 3 building, which separates a sole occupancy unit from a stairway, public corridor, public lobby or the like, to have a minimum sound insulation rating of R_w30 .

The following published test standards detail test methods and guidance on the measurement and application of results to determine single figure sound insulation ratings.

AS1191: 2002/ISO140.3: 1995/ISO10140.2: 2010 – Acoustics - Method for laboratory measurement of airborne sound insulation of building elements.

These standards specify the laboratory method for measuring the airborne sound reduction index for building elements such as walls, doors, windows and other space dividing elements. The values of sound reduction index measured in accordance with these standards may be applied to AS/NZS ISO717.1: 2004 to calculate a single number that characterises an acoustical performance. This is the weighted sound reduction index R_w .

AS/NZS ISO 717-1: 2004 – Rating of airborne sound insulation in buildings & building elements.

As mentioned above, this standard provides a set of rules for determining single figure R_w results from the results of tests conducted in accordance with AS1191/ISO140.3. The standard defines single number values for airborne sound insulation in building elements and takes into consideration the different sound level spectra of various noise sources within the building and its environment.

Fire Resistance/Fire Door Assemblies

The Building Code of Australia (BCA) regulates the fire resistance of building elements in Part C and stipulates where fire doors are required in a building's design and what level of fire-resistance is required. Specification C3.4 details the requirements for fire door assemblies and mandates they comply with the requirements of AS1905.1: 2005.

AS1905.1: 2005 – Components for the fire protection of openings in fire resistant walls Part 1: Fire doors.

This standard specifies requirements for the construction and installation of fire-resistant door sets used to protect openings in walls and partitions that are required to resist the passage of fire. The fire resistance level of a fire door assembly is determined by testing in accordance with AS1530.4.

AS1530.4 – Fire resistance tests of elements of building construction.

This standard provides building designers, manufacturers, test laboratories and regulatory authorities with a set of uniform requirements and criteria for the determination of a building elements fire resistance level by subjecting it to standardised fire exposure conditions.

It is important to note that Australian fire door designs are proprietary by nature. It is therefore a requirement that door seals and other items of essential hardware are tested in accordance with AS1530.4 with each fire door manufacturer's door type, ensuring they do not compromise the assembly's established fire resistance level.

Smoke Control

Smoke door assemblies are designed to improve life safety in buildings by limiting the spread of smoke through door openings and ensuring exit paths remain un-obscured and functional. Typical applications include lift lobbies, hospital corridors, hotels and unit entry doors in multi-residential apartments.

Currently a smoke door assembly must meet the 'deemed to satisfy' provisions of Specification C3.4 Part 3 of the Building Code of Australia (BCA), unless otherwise specified.

With the introduction of a performance based BCA, the use of smoke doors has increased, leading to a need to adequately specify and install doors having a quantifiable level of smoke leakage performance. Two Australian Standards have been developed to help improve life safety in buildings by limiting the spread of smoke through door openings, and providing parameters for door assembly performance based on allowable leakage rates at given temperatures and pressures.

AS6905: 2007 – Smoke Doors.

This standard sets out the requirements for the specification, construction and installation of smoke door assemblies and provides important guidance on maximum allowable smoke leakage rates for single and double door configurations

AS1530.7: 2007 – Methods for fire tests on building materials, components and structures. Part 7 – Smoke control assemblies – Ambient and medium temperature leakage test procedure.

This standard sets out a method to measure the leakage of ambient and medium temperature smoke from one side of a door assembly to the other under specified test conditions.

Building Regulations and Associated Standards *cont'd*

Bushfire Risk

The Building Code of Australia (BCA) regulates construction in bushfire prone areas for Class 2 to 9 buildings in section G, Part G5 and for Class 1 and 10 buildings Part 3.7.4 and requires construction in accordance with AS3959: 2009.

(It should be noted that States' and Territories' requirements vary so please check with your local regulatory authority as to what regulations may exist for your region.)

AS3959: 2009 – Construction of buildings in bushfire prone areas.

This standard specifies requirements for the construction of buildings in bushfire-prone areas in order to improve their resistance to bushfire attack from burning embers, radiant heat, flame contact and combinations of the three attack forms. The standard is limited to those buildings where the Bushfire Attack Level (BAL) has been determined as BAL- LOW, BAL-12.5, BAL-19, BAL-29, BAL-40 or BAL-FZ (Flame Zone) and provides detailed guidance on construction requirements for each attack level.

Door perimeter and door bottom seals from the Kilargo range incorporating brush filaments and silicone rubber gaskets provide door sealing solutions as required by this standard.

The Standards utilised to measure and evaluate material performance for each attack level include:

AS1530.8.1:2007 – Tests on elements of construction for buildings exposed to simulated bushfire attack – Radiant heat and small flaming sources.

This Standard specifies methods for determining the performance of external construction elements when exposed to radiant heat, burning embers and burning debris.

AS1530.8.2:2007 – Tests on elements of construction for buildings exposed to simulated bushfire attack – Large flaming sources.

This Standard specifies methods for determining the performance of external construction elements when exposed to direct flame impingement from the fire front.

Conservation of Energy & Weather Exclusion

Door seals greatly assist in increasing the energy efficiency of air conditioned environments by providing a barrier to

unwanted hot or cool air movement. They can immediately increase comfort levels and assist with the control of cold drafts or rain infiltration.

The BCA recognises the need to reduce greenhouse gases and use energy in a more sustainable manner. Section J Part J3.4. C provides guidance on energy efficiency measures and specifically the draft proofing treatment of doors that form part of an envelope of a conditioned space, the external fabric of a habitable room or public area in climate zones 4, 5, 6, 7 and 8 (note: fire and smoke doors are excluded).

Although the BCA sets out specific guidelines for energy efficiency in buildings, large climatic variances mean that States and Territories of Australia apply their own Building Control Acts, which specify their own energy efficiency schemes and requirements. Please check with your local regulatory authority about regulations for your region.

Accessibility & Mobility

The BCA recognises the need to provide people (as far as is reasonable) with safe, equitable and dignified access to a building, the services and facilities within a building; and safeguard occupants from illness or injury while evacuating in an emergency. Section D, Part D.3 provides guidance on access for people with disability and makes reference to AS1428.1

AS1428.1 2009 Design for Access and Mobility: Part 1: General requirements for access—New building work.

This standard specifies the design requirements for new building work to provide access for people with disabilities. Particular attention is given to continuous accessible paths of travel and circulation spaces for people who use wheelchairs; access and facilities for people with ambulatory disabilities; and access for people with sensory disabilities.

The standard includes maximum door opening and closing forces for ease of door operation, threshold heights and door width requirements. Appropriate combinations of Kilargo seals offer very low frictional forces in operation, thereby eliminating any increase to the opening and closing forces of the door.

Easy Selection

To help you choose the right door seal for your project or specification, the following symbols are used throughout this brochure.

Use the key below to identify, at a glance, what each product is designed to do.



Ambient (cold) temperature smoke:

Seals for this designation are designed to control smoke at ambient temperature conditions.



Medium temperature smoke:

Seals for this designation are designed to contain smoke at 200° C for 30 minutes exposure, as per the 'deemed-to-satisfy' requirements of Specification C3.4 of the Building Code of Australia.



Medium Temperature Smoke (200°C):

Designed to contain smoke at 200° C for 30 minutes.



Hot smoke:

Hot smoke seals incorporate an intumescent material that rapidly expands in volume upon heating. These types of seals limit the spread of hot smoke and gases produced by fully developed fires.



Approved for use on proprietary smoke doors:

Seals for this designation have been tested in accordance with AS1530/7 for smoke leakage, providing ambient or medium temperature leakage rates across various pressures.



Approved for use on proprietary fire doors:

Fire tests to AS1530/4 have been conducted on one or more proprietary fire door constructions to show that the addition of these seals will not affect the already established fire resistance levels of the fire doors. Strict compliance with AS1905/1 requires each door type to be tested with each item of hardware. For each project, please check with the respective fire door manufacturer to verify that their door construction has the relevant listing for Kilargo Seals.



Antimicrobial version available

SteriTouch® range of antimicrobial seals are designed to reduce the growth of harmful organisms such as bacteria, mould and fungi, while remaining safe for even the most sensitive applications. Based on established silver technology SteriTouch® is particularly effective against illness causing bacteria such as MRSA, E. Coli and Salmonella.



Sound containment (acoustics):

Testing for door assemblies incorporating these seals has been conducted to AS1191 and/or ISO140 Part 3/ISO10140.2 both Rw and STC single value ratings are available as calculated using the principles of AS/NZS ISO717.1.



Design for access & mobility:

When installed as per our instructions, these seals offer very low frictional forces, thereby eliminating any increase to the opening and closing forces of the door—an important consideration when meeting the requirements of AS1428/1.



Energy efficient:

Door assemblies fitted with appropriate seals can greatly assist in reducing air movement within buildings. Whether controlling warm or cool air, seals play a vital role in maintaining the equilibrium of air conditioned spaces. Reducing leakage paths greatly assists in improving the overall energy efficiency of the building.



Bushfire Attack Level 12.5-29 in accordance with AS3959



Bushfire Attack Level 40 in accordance with AS3959



Bushfire Attack Level Flame Zone in accordance with AS3959

NOTE: Use of the icons does not necessarily indicate that test evidence exists. Please check with our technical team.

Purchase Kilargo products through Access Hardware to earn 1 Qantas Point per \$1 spent for your business*

Perimeter Seals 1000 Series

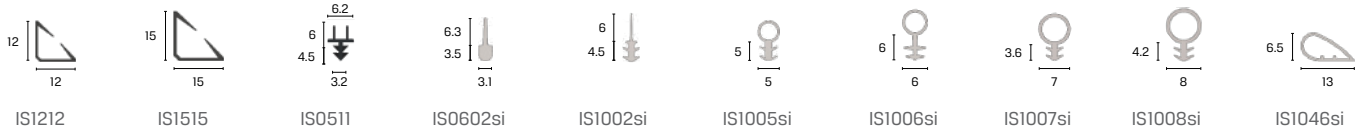

Door Bottom Seals 3000 Series

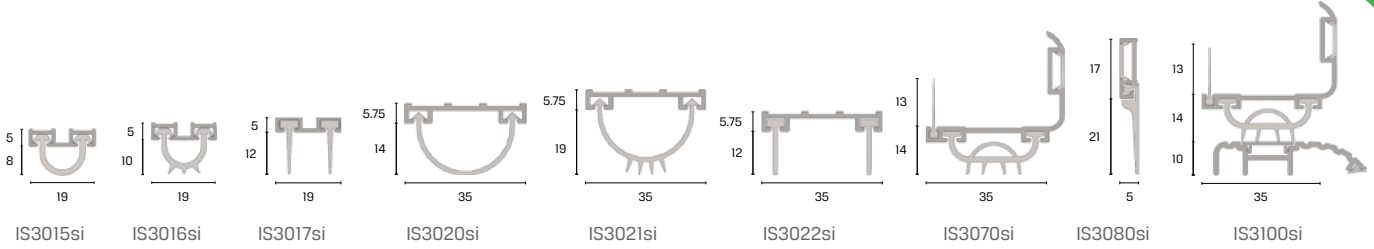

Threshold Plates and Ramps 4000 Series

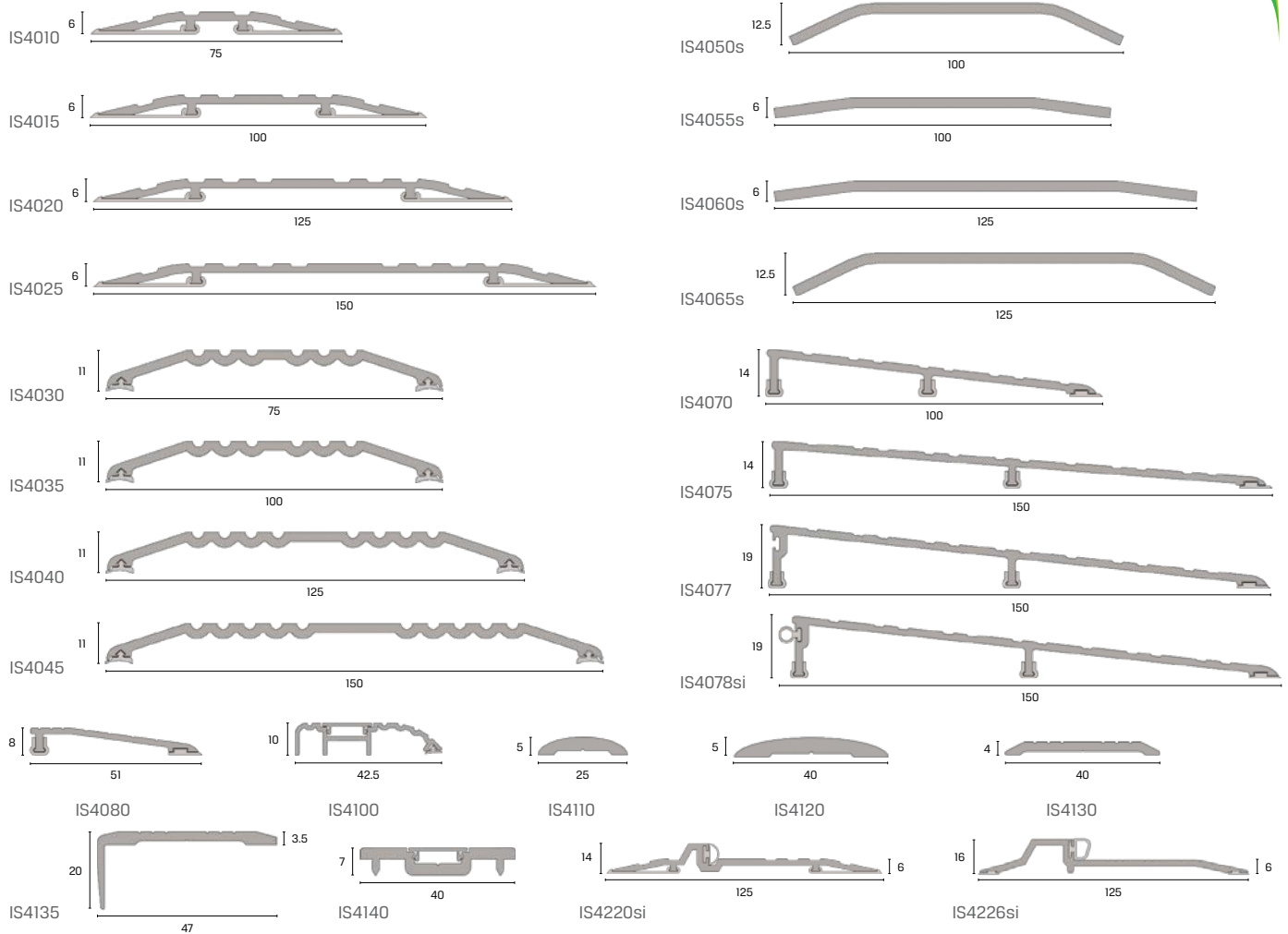

Sweep Action Seals 5000 Series

*Additional product lengths available on certain profiles, please refer product page for more information.

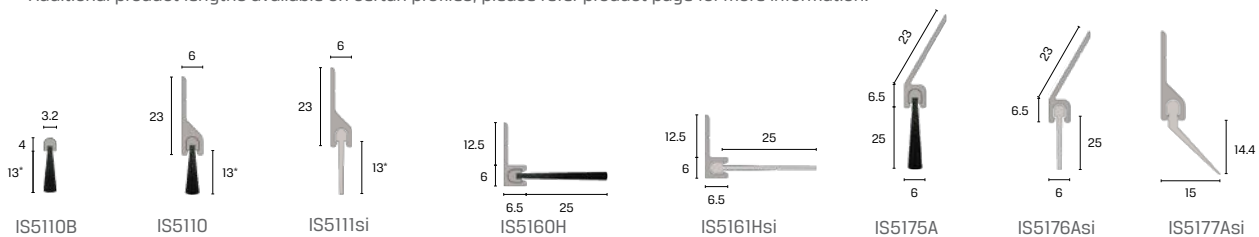

Magnetic Seals 6000 Series

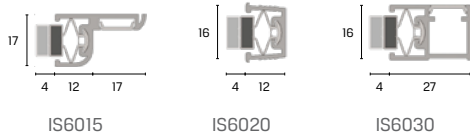

IS6015

IS6020

IS6030



All dimensions are given in mm and illustrations are not to scale.

Perimeter Seals 7000 Series

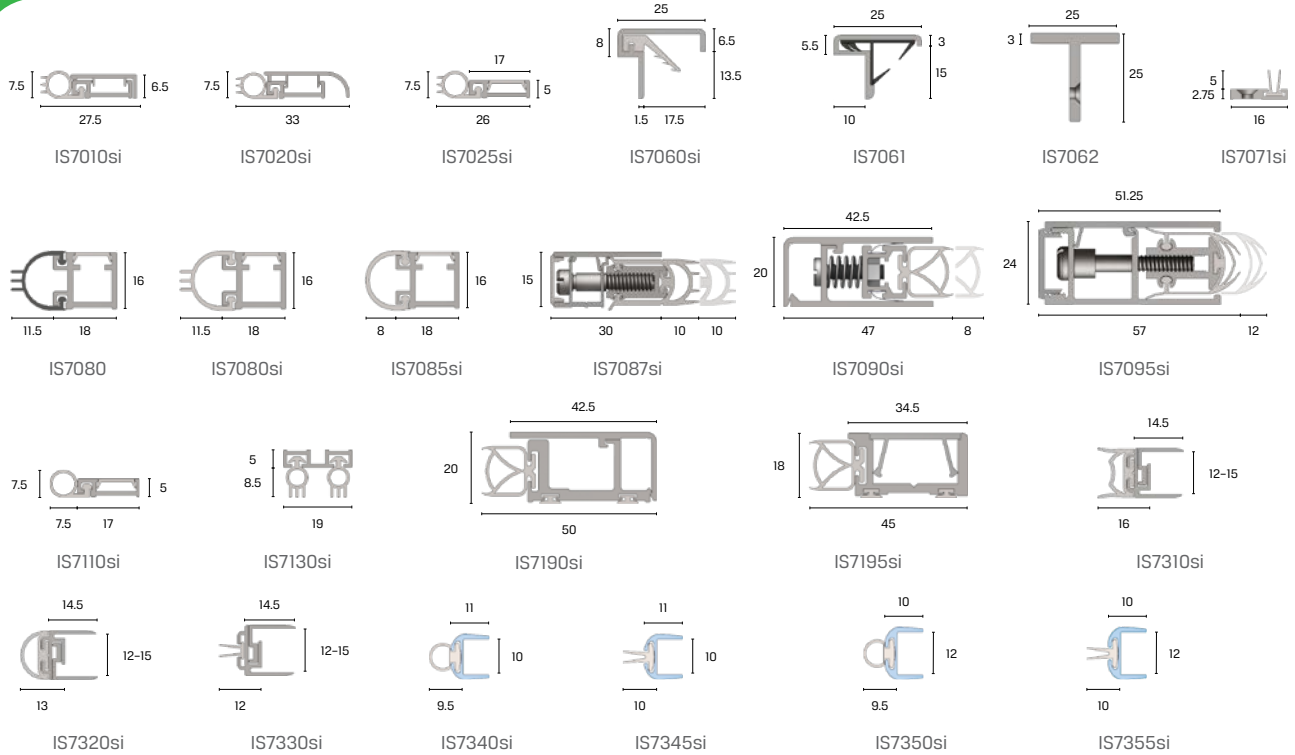

Automatic Door Bottom Seals 8000 Series

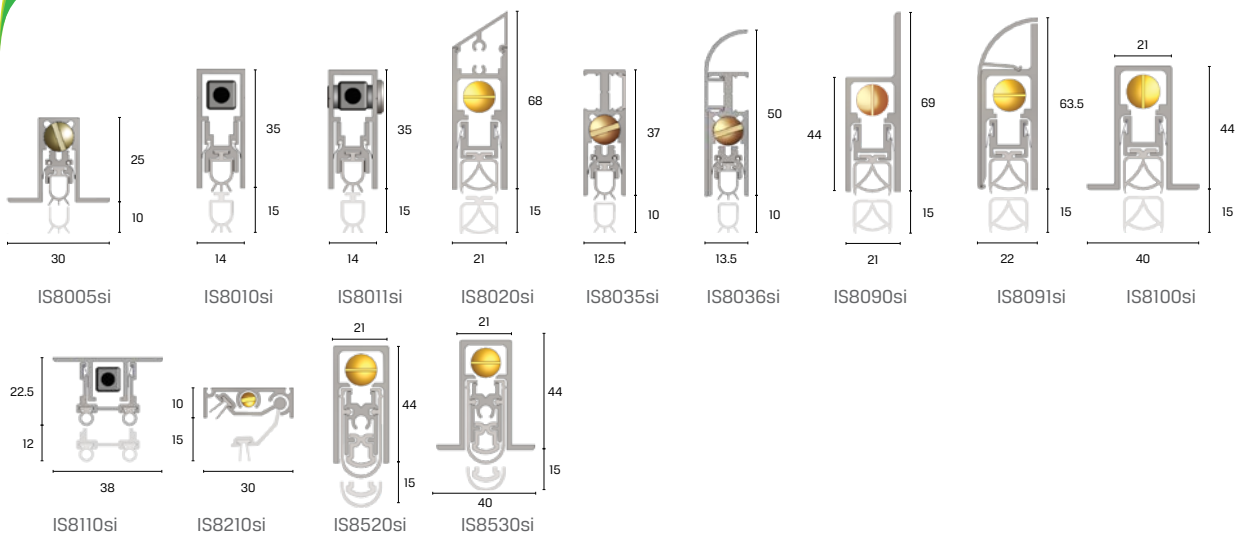

Specialty Seals 9000 Series

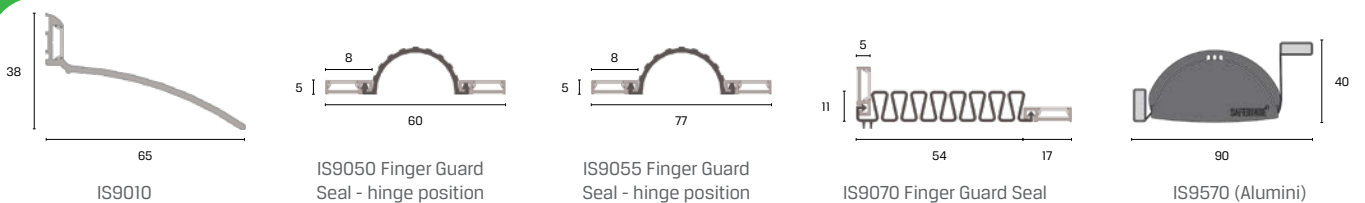

Intumescent Fire and Smoke Seals

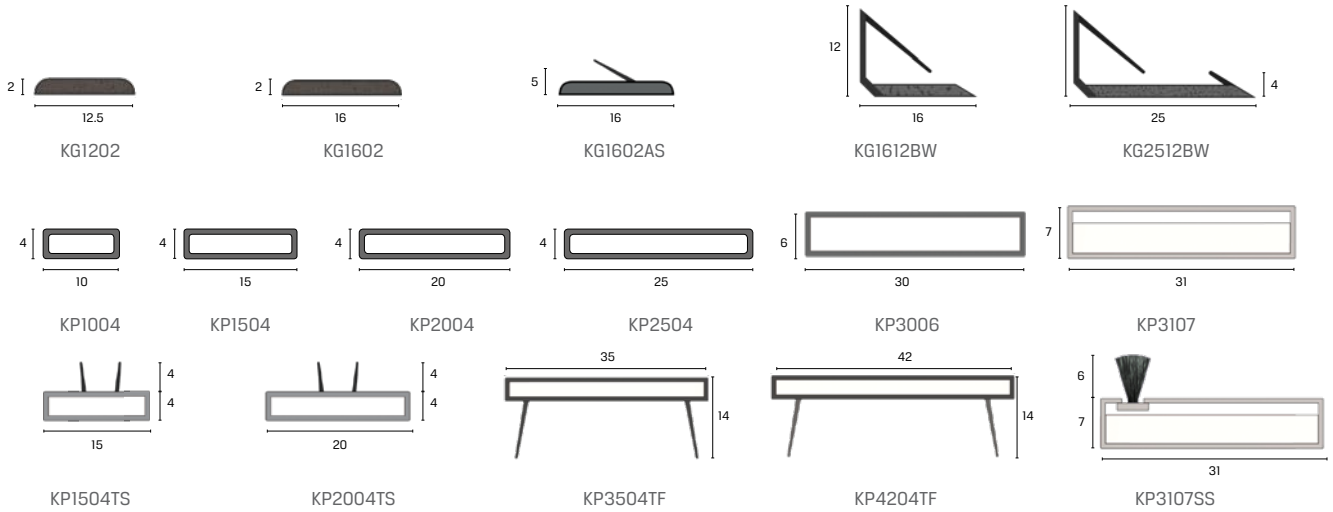

Fire Door Meeting Stile Seals

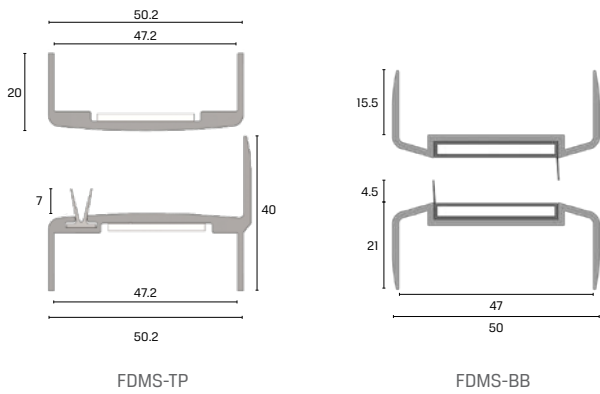

Fire Door Upgrade Seals

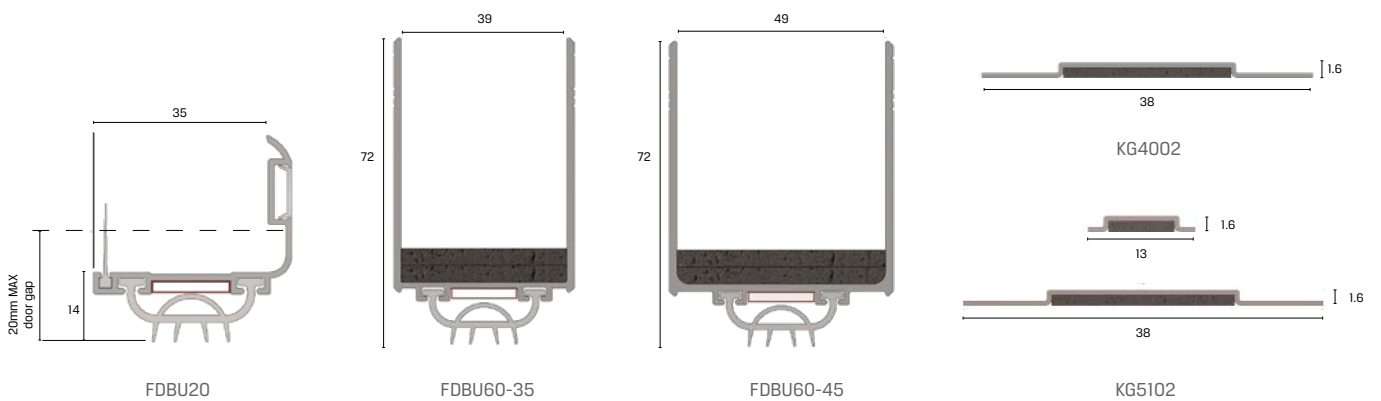

Fire Door Ventilation Grilles



IFD-D

Antimicrobial Seals 1000 Series

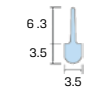

IS0602AMsi



IS1002AMsi



IS1005AMsi



IS1006AMsi



IS1007AMsi



IS1008AMsi

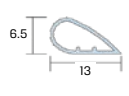

IS1046AMsi

Antimicrobial Seals 3000 Series

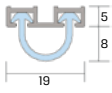

IS3015AMsi

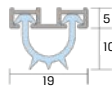

IS3016AMsi

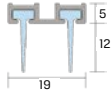

IS3017AMsi

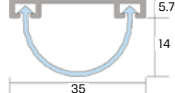

IS3020AMsi



IS3021AMsi

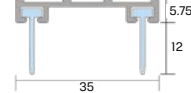

IS3022AMsi

Antimicrobial Seals 5000 Series

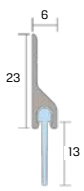

IS5111AMsi

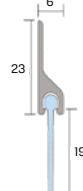

IS5116AMsi

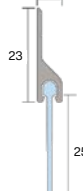

IS5121AMsi

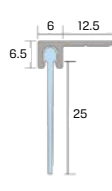

IS5161HAMsi

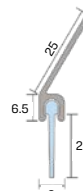

IS5176AAMsi

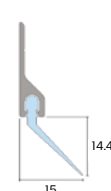

IS5177AAMsi

Antimicrobial Seals 7000 Series



IS7010AMsi



IS7020AMsi



IS7025AMsi

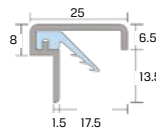

IS7060AMsi

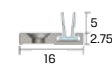

IS7071AMsi

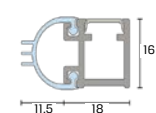

IS7080AMsi

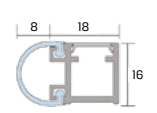

IS7085AMsi

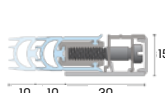

IS7087AMsi

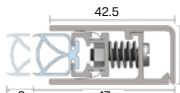

IS7090AMsi

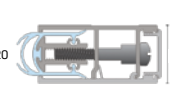

IS7095AMsi

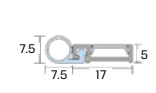

IS7110AMsi

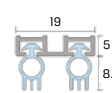

IS7130AMsi

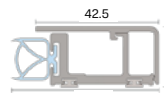

IS7190AMsi

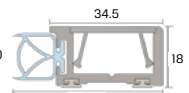

IS7195AMsi

Antimicrobial Seals 8000 Series

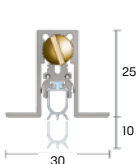

IS8005AMsi

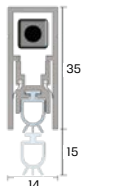

IS8010AMsi

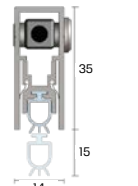

IS8011AMsi

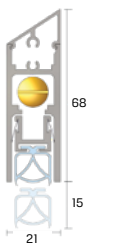

IS8020AMsi

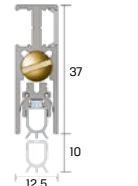

IS8035AMsi

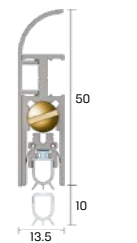

IS8036AMsi

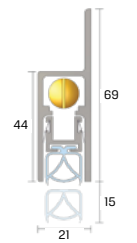

IS8090AMsi

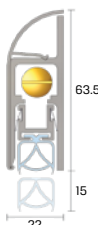

IS8091AMsi

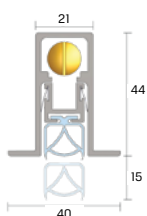

IS8100AMsi

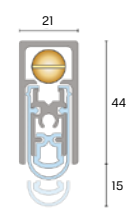

IS8520Asi

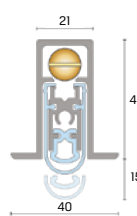

IS8530Asi



All dimensions are given in mm and illustrations are not to scale.



Black Anodising Back to Black

Never go out of style with our classic matt black anodised finish. Sleek, smooth, always stylish.

So you can get that classic look, Kilargo has been providing powder-coated black coloured architectural door seals for years. Now, we're offering your favourite Kilargo products in a smooth black anodised finish.

- Anodised at 20 microns for superior durability
- Fast lead times
- Same Australian made, Kilargo quality



Start specifying black anodised seals today! www.kilargo.com.au

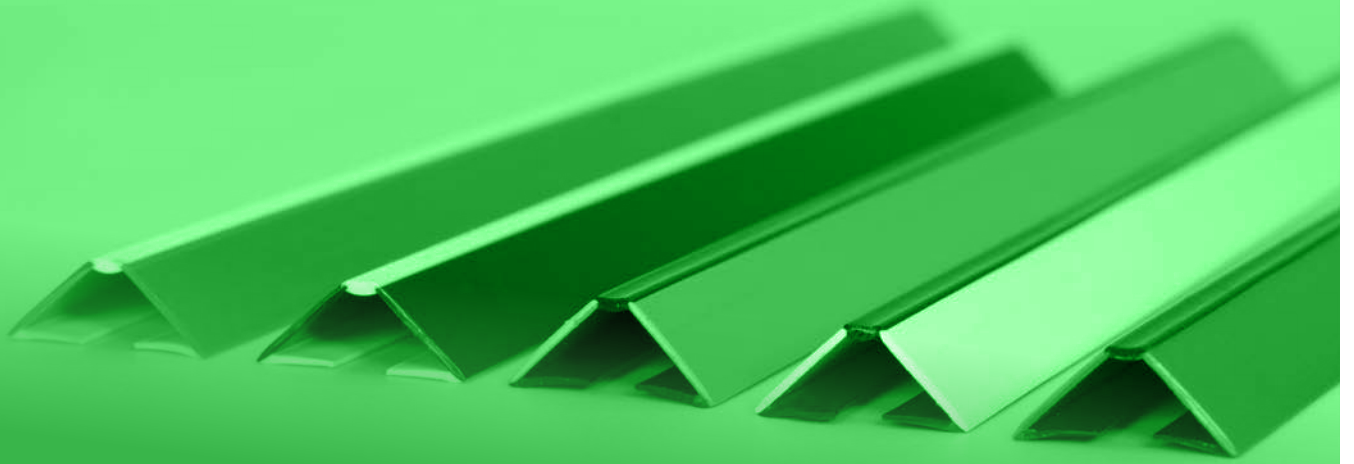

1000 SERIES

Perimeter Seals

-  A comprehensive range of self-adhesive and kerf-fitting seals, helping to provide a barrier to smoke, sound and weather.

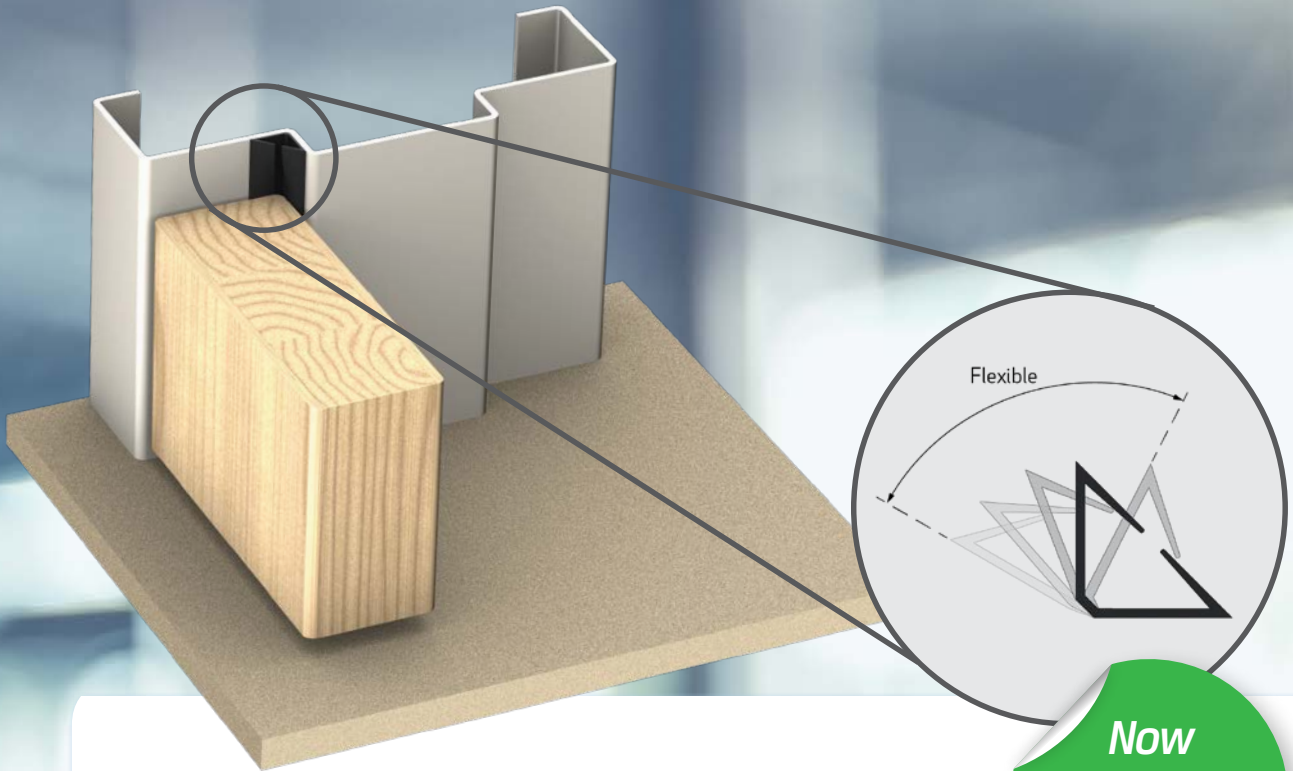



Now
available
in Clear

Flexi-Wing[®] Seals

Functional, flexible performance!

From constant Kilargo innovation comes even better performance. Introducing the Flexi-Wing[®] hinge, created to improve the functionality of the IS1212/IS1515 perimeter seals.

Strategically located in the impact free zone, the new Flexi-Wing™ offers:

-  Superior fire, smoke and acoustic performance
-  Reduced friction and resistance in door opening and closing
-  Easier installation - resolving any potential issues such as door frames being out of square, whether acute or obtuse.

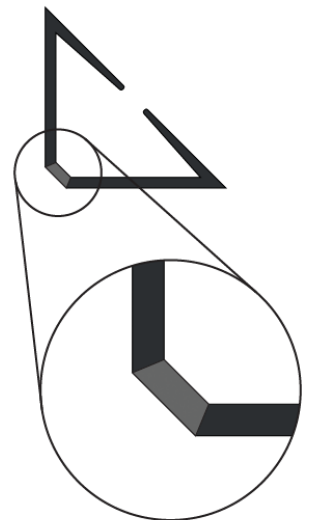

Talk to us today!

www.kilargo.com.au

IS1212, IS1515 Flexi-Wing®



These self-adhesive perimeter seals are fitted in the rebate of a door frame to contain smoke, sound, draughts, dust and light. Strategically located in the impact free zone, the seal adheres to the frame quickly and easily without having to remove the door.

The seal consists of a semi-rigid flame retardant PVC carrier combined with twin elastomeric sealing blades. An aggressive self-adhesive backing tape is situated on both sides of the carrier. NB. To ensure proper adhesion, contact surfaces must be clean & any paint well-cured.

Gap size

- IS1212: Required door clearance 2-3mm
- IS1515: Required door clearance 4-5mm

Door set standard lengths

- Single: 1 x 1000mm, 2 x 2100mm
- Long Single: 1 x 1000mm, 2 x 2750mm
- Double: 3 x 2100mm
- Long Double: 1 x 2100mm, 2 x 2750mm

Standard lengths

- 1000mm
- 2100mm
- 2400mm
- 2700mm
- 3000mm

Standard colours

- Black
- White
- Clear
- (Dark brown and grey available to special order)

Approval/s

- Fire tested to AS1530 Part 4 in accordance with AS1905 Part 1
- UL Certifications GYI.R26629, GVWZ.R26629, GVWZ7.R26629
- Medium temperature smoke leakage approvals to AS1530 Part 7 available on proprietary door assemblies
- Acoustically tested in accordance with AS1191, IS0140.3 and IS010140-2
- Durability tests demonstrating over 100,000 open & close cycles

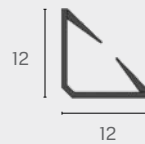

IS1212

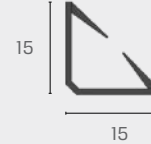

IS1515

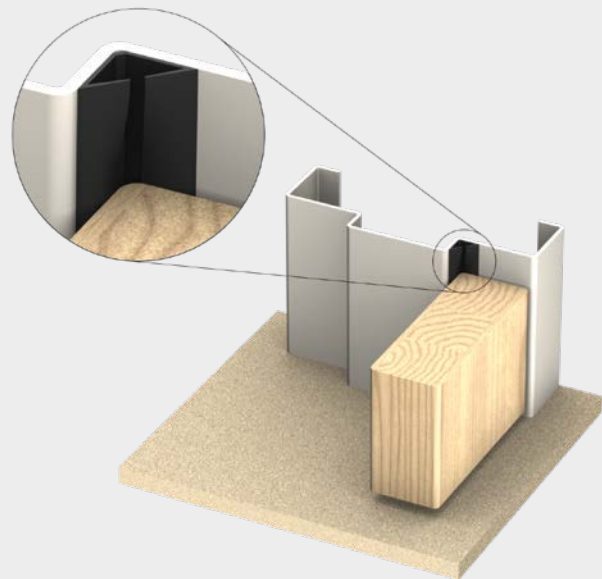

For more product information please scan QR code or visit www.kilargo.com.au/ourproducts/is1212/



All seals proudly manufactured in Australia

ISO511-T4, ISO511-T6



Incorporated into door assemblies for its medium temperature smoke and acoustic properties. Also used as a privacy seal on toilet cubicle doors.

This rigid PVC base seal has co-extruded flame retardant, twin flexible smoke and acoustic fins. It fits quickly and easily into a nominal 3mm (wide) by 5mm (deep) interference fit groove.

* This seal is available with either a 4mm or 6mm fin height.

Product & Gap Sizing

- 4mm Fin Height > min. 2mm / max. 3mm
- 6mm Fin Height > min. 3mm / max. 5mm

Standard lengths

- 1000mm
- 2100mm
- 2400mm
- 2700mm
- 3000mm

Standard colours

- Black (white, grey & dark brown colours available to special order)

Approval/s

- Fire tested to AS1530 Part 4 in accordance with AS1905 Part 1
- Medium temperature smoke leakage approvals to AS1530 Part 7, compliant with AS6905 on proprietary door assemblies
- Conforms with BCA Specification C3.4 smoke sealing requirements
- Acoustically tested in accordance with AS1191, ISO140.3 and ISO10140-2
- Durability tests demonstrating over 100,000 open and close cycles

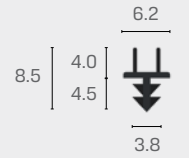
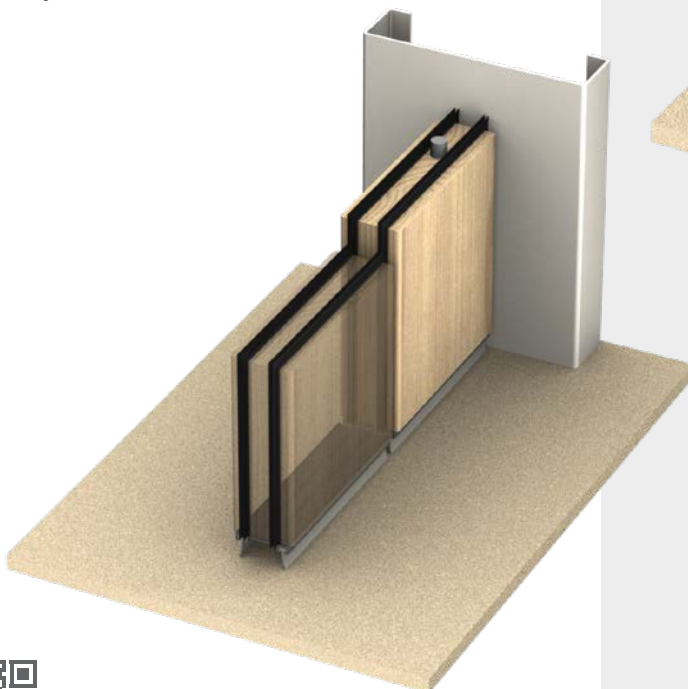

ISO511-T4

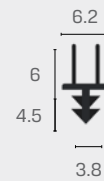

ISO511-T6

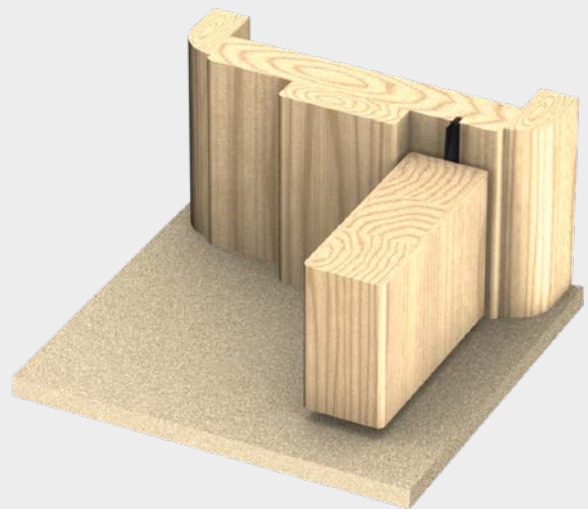

For more product information please scan QR code or visit www.kilargo.com.au/ourproducts/is0511/



All seals proudly manufactured in Australia

ISO602si



A flexible silicone wipe seal that is kerf mounted into pre-fabricated aluminium doors and window perimeter sections. The high performance silicone rubber seal is simply pressed into a pre-fabricated groove in the frame rebate or door edge. (Please check with the aluminium door fabricator for compatibility of this seal section).

Gap size

- Min. 3mm / max. 5mm

Standard lengths

- 50 metre coils

Standard colours

- Grey

Approval/s

- Conforms with BCA Specification C3.4 smoke sealing requirements
- Acoustically tested in accordance with AS1191, ISO140.3 and ISO10140-2



For more product information please scan QR code or visit www.kilargo.com.au/ourproducts/is0602si/

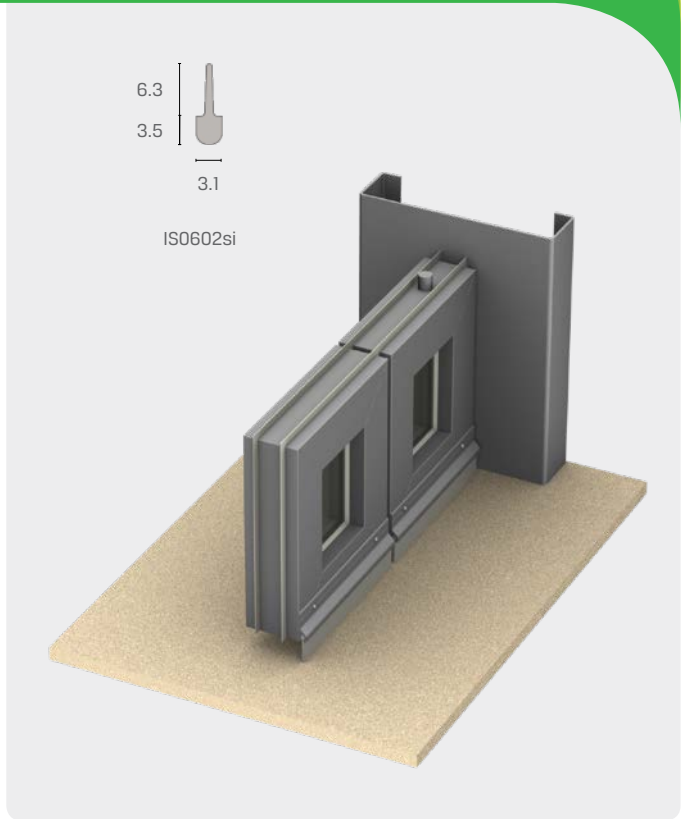

1000 Series

IS1002si



A durable silicone wipe seal, that is kerf mounted into door rebates or aluminium door stiles. The high performance silicone rubber seal is simply pressed into a nom. 3mm (wide) x 5mm (deep) groove (or saw cut) in the frame rebate or door edge.

Gap size

- Min. 3mm / max. 5mm

Standard lengths

- 50 metre coils

Standard colours

- Grey

Approval/s

- Fire tested to AS1530 Part 4 in accordance with AS1905 Part 1
- Conforms with BCA Specification C3.4 smoke sealing requirements
- Acoustically tested in accordance with AS1191, ISO140.3 and ISO10140-2



For more product information please scan QR code or visit www.kilargo.com.au/ourproducts/is1002si/



IS1005si, IS1006si, IS1007si, IS1008si



Durable, bulb-type silicone compression seals, which can be easily kerf mounted into the rebates of timber door and window frames. These provide ideal smoke and acoustic seals for single action doors. These silicone compression seals can be fitted into a nominal 3mm wide kerf of sufficient depth.

Gap size

- IS1005si: Required Door Clearance 3-5mm
- IS1006si: Required Door Clearance 3-6mm
- IS1007si: Required Door Clearance 4-7mm
- IS1008si: Required Door Clearance 5-8mm

Standard lengths

- 50 metre coils

Standard colours

- Black
- Grey
- (Dark brown available to special order)

Approval/s

- Conforms with BCA Specification C3.4 smoke sealing requirements
- Acoustically tested in accordance with AS1191, IS0140.3 and IS010140-2

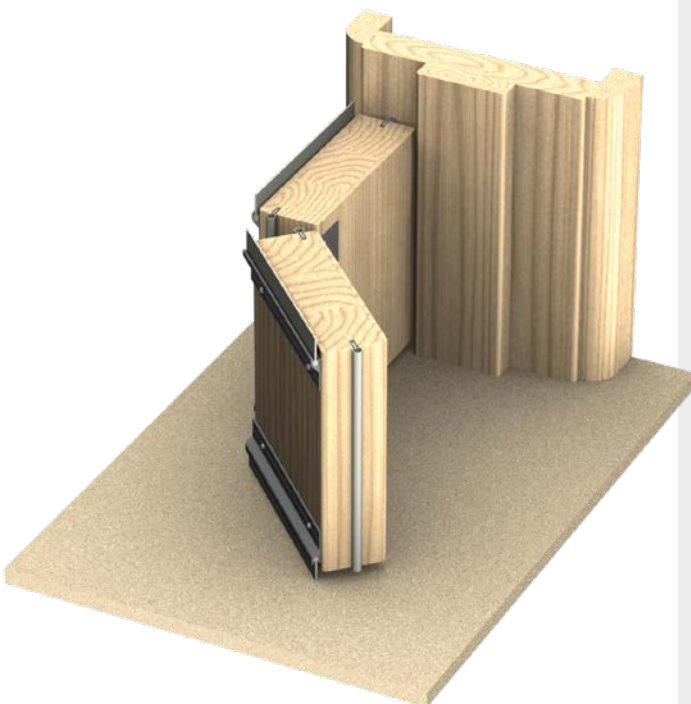
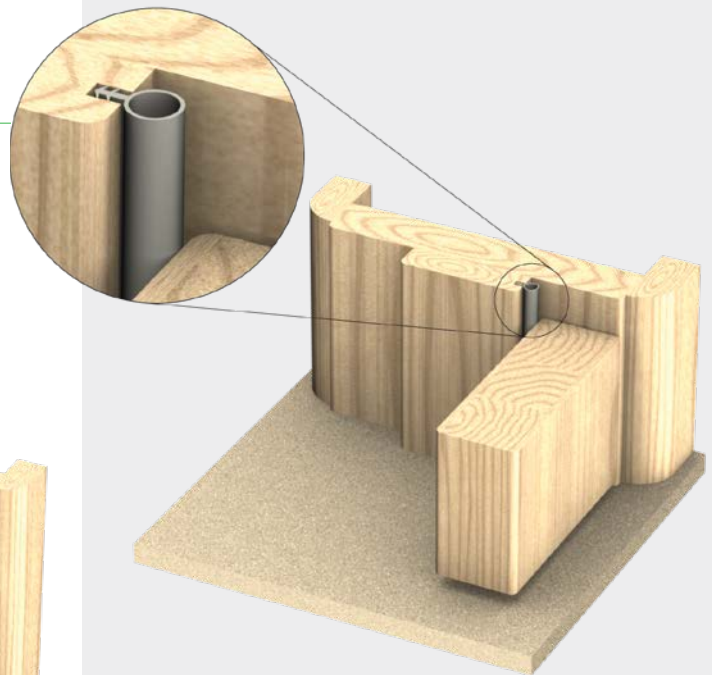
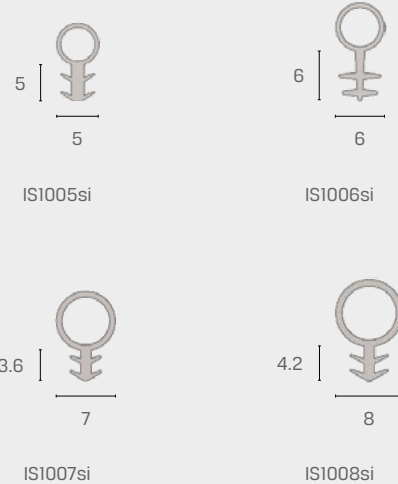

For more product information please scan QR code or visit www.kilargo.com.au/ourproducts/is1005si/



All seals proudly manufactured in Australia

IS1046si



A durable silicone compression seal with self-adhesive backing, mounted against door stops around perimeters of single swing doors. This bulb version has reinforced ribs to provide extra strength in service.

NB. When adhering to frames, contact surfaces must be clean.

Gap size

- Min. 3mm / max. 5mm

Standard lengths

- 50 metre coils

Standard colours

- Black
- Grey
- (Dark brown available to special order)

Approval/s

- Fire tested to AS1530 Part 4 in accordance with AS1905 Part 1
- Certifications GVI.R26629, GVWZ.R26629, GVWZ7.R26629
- Medium temperature smoke leakage approvals to AS1530 Part 7, compliant with AS6905 on proprietary door assemblies
- Acoustically tested in accordance with AS1191, IS0140.3 and IS010140-2

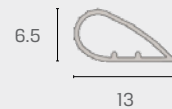
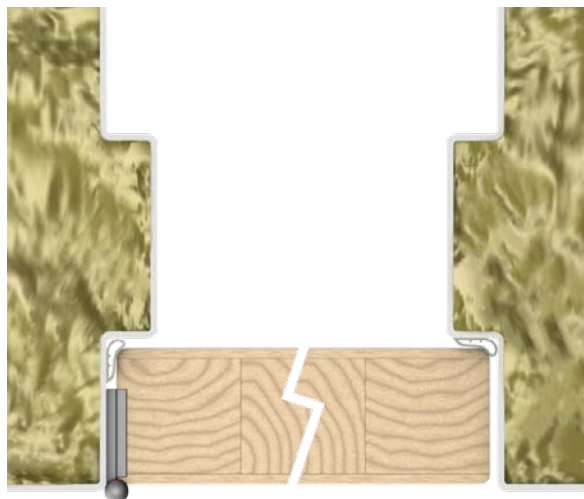

IS1046si

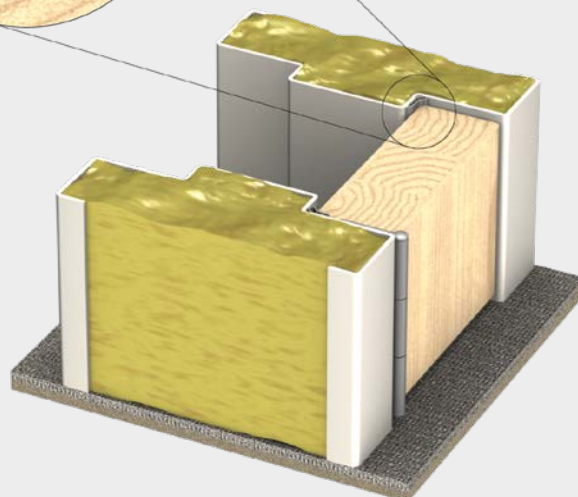
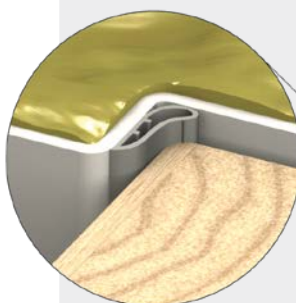
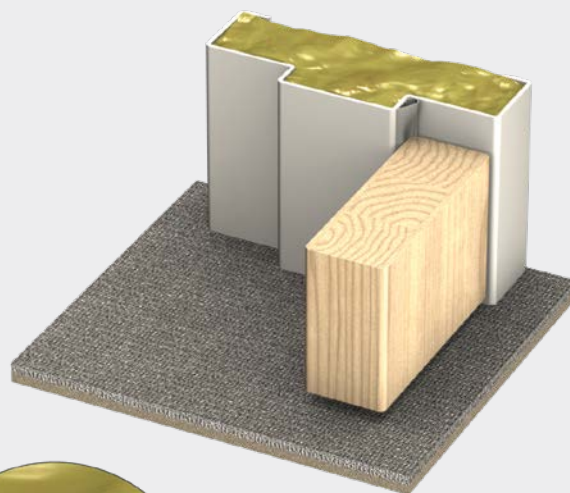

1000 Series



For more product information please scan QR code or visit www.kilargo.com.au/ourproducts/is1046si/



All seals proudly manufactured in Australia

Location: Missenden Road, NSW

Client: Chris O'Brien Lifehouse

Architect: Rice Daubney

Builder: Brookfield Multiplex

Completion: 2013-2014

One of the health sector's newest specialist medical facilities, the Master Builder award-winning Chris O'Brien Lifehouse is a world-class comprehensive cancer centre.

This state of the art facility offers a unique model of care for patients, with integrated care, complementary therapies, research and education all taking place under the one roof. Opened to patients in 2013, it became fully operational in early 2015 with the opening of inpatient services, including 125 overnight beds, eight operating theatres and an intensive care unit.

Drawing on our extensive health sector experience, Kilargo proudly provided premium architectural sealing solutions for this project.

The simple and smart solution

This multi-purpose facility required a variety of Kilargo sealing solutions for fire, smoke, acoustics and antimicrobial containment. We worked collaboratively with the nominated specifiers to ensure each area of Chris O'Brien Lifehouse was equipped with the seals required – from food service areas, operating theatres to research labs.

Antimicrobial seals were used on the bottom of pivot doors in the medical imaging rooms to reduce the risk of harmful bacteria such as MRSA, E. Coli and salmonella breeding. As one of the only Australian architectural seal companies with our own on-site research facility, our antimicrobial door sealing solutions are tried and tested, which is essential in this sensitive environment.

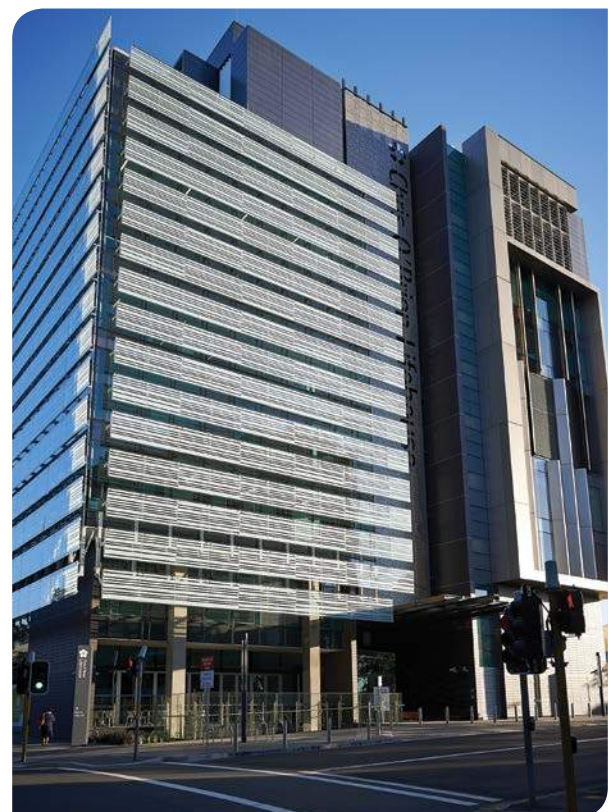

Images courtesy of Chris O'Brien Lifehouse

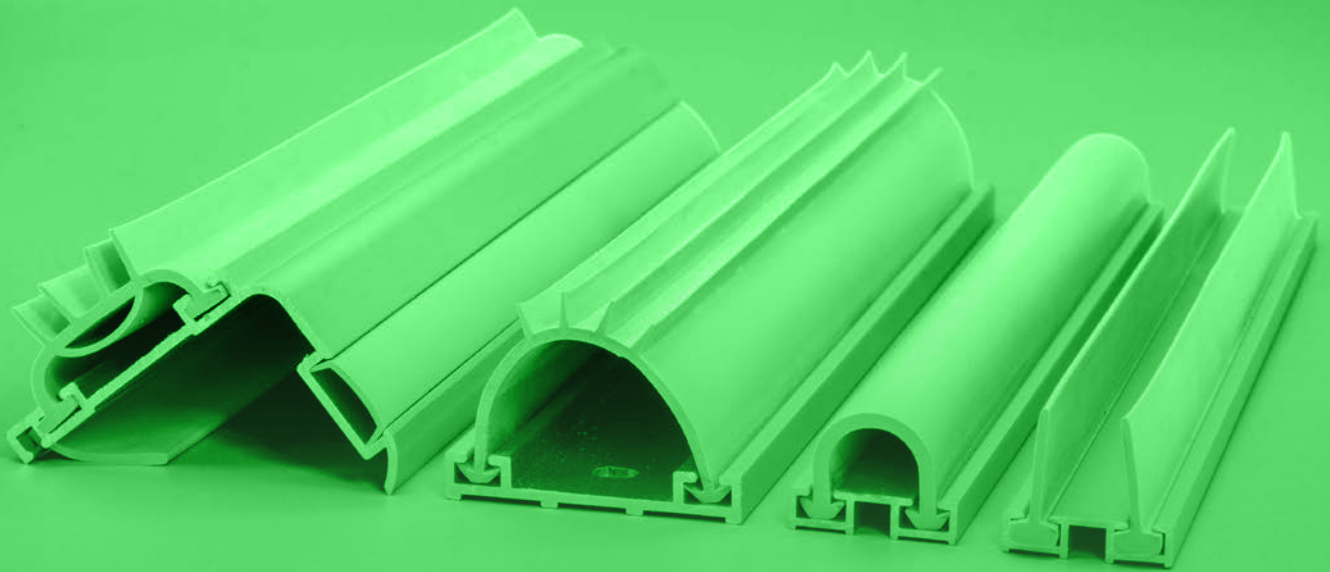

3000 SERIES

Threshold (Door Bottom) Seals



Ideal for sealing the gap between the door bottom and the floor - a commonly overlooked area that is essential to achieve containment.

IS3015si, IS3016si, IS3017si



The IS3015si and IS3016si seals are cleverly concealed in a rebated groove in the meeting stile or bottom of the door leaf (respectively) for single and double swing timber doors. These seals may be surface mounted or rebated into doors to allow for depth adjustment as required. Both seals can provide effective containment against medium and ambient temperature smoke, sound, dust, light, weather and vermin.

The IS3017si is a sweep action blade seal with high performance silicone rubber fins, which can be fitted to door bottoms or perimeters of single and double action doors. This seal may be surface mounted or rebated into doors to allow for depth adjustment as required. This seal provides effective containment against dust, light, weather and vermin, and is an ideal smoke seal for pivot door assemblies.

Gap size

- IS3015si: Min. 3mm / max. 8mm
- IS3016si: Min. 5mm / max. 9mm (allowing for the aluminium carrier to be recessed).
- IS3017si: Min. 8mm / max. 12mm

Standard lengths

- 1000mm
- 2250mm
- Also available in: 250mm increments from 1000mm to 5000mm

Standard colours

- IS3015si and IS3016si: Silver anodised aluminium with grey silicone gasket (Black silicone gaskets also available upon request)
- IS3017si: Silver anodised aluminium section with grey silicone fins (Black silicone fins also available upon request)

Fixing

- Timber fixing screws are supplied with detailed fitting instructions
- Fixing holes are pre-drilled and slotted to allow the seals to be positioned accurately

Approval/s

- Conforms with BCA Specification C3.4 smoke sealing requirements
- Acoustically tested in accordance with AS1191, IS0140.3 and IS010140-2

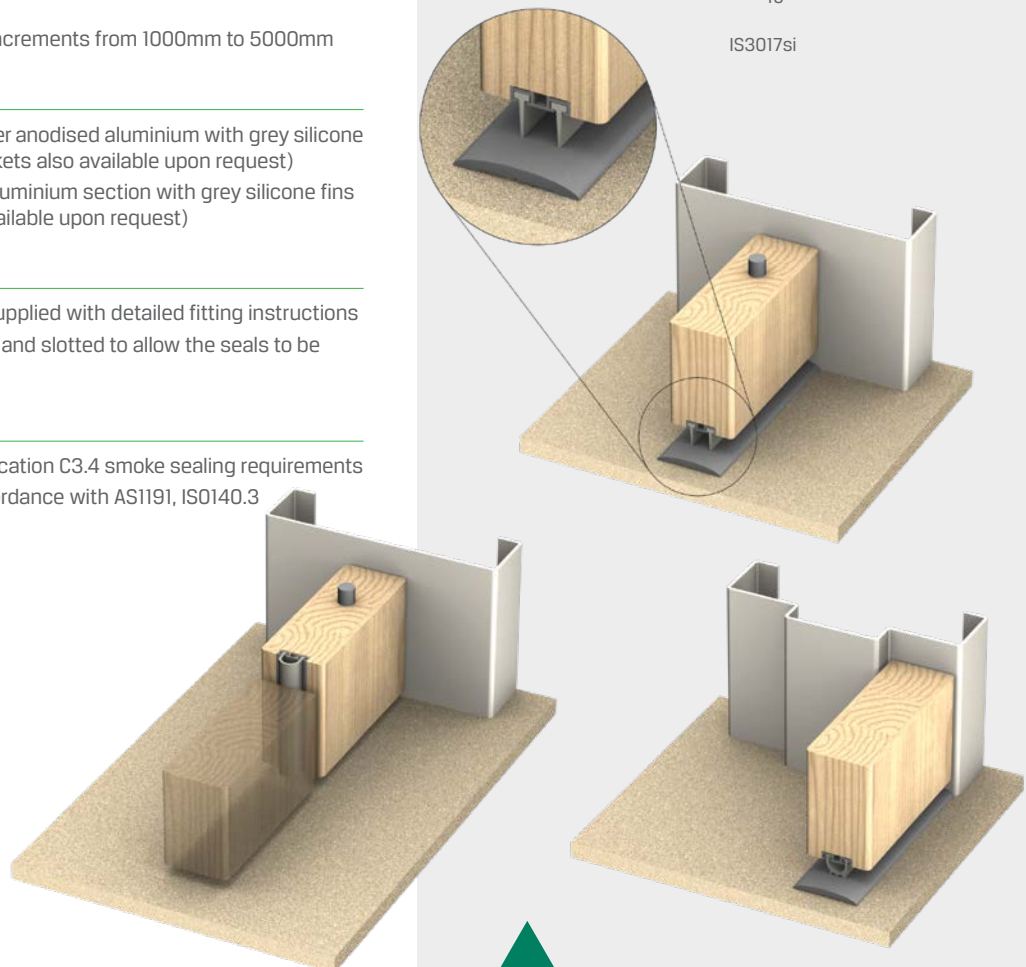
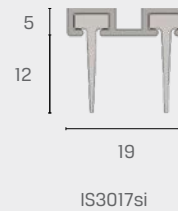
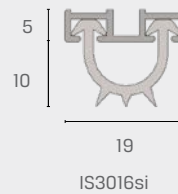
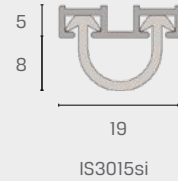

For more product information please scan QR code or visit www.kilargo.com.au/ourproducts/is3015si/



All seals proudly manufactured in Australia

IS3020si, IS3021si, IS3022si



The IS3020si and IS3021si (finned) seals can be fitted to door bottoms or meeting stiles of single and double action doors. They can also be utilised for door bottoms on roller type doors.

Both seals can provide effective containment against medium and ambient temperature smoke, sound, dust, light, weather and vermin.

The IS3022si is a sweep action blade seal with high performance silicone rubber fins, which can be fitted to door bottoms or perimeters of single and double action doors. This seal can provide effective containment against dust, light, weather and vermin, and is an ideal smoke seal for pivot door assemblies.

Gap size

- IS3020si: Min. 15mm / max. 19mm
- IS3021si: Min. 20mm / max. 24mm
- IS3022si: Min. 13mm / max. 17mm (allowing to be surface-mounted onto the door).

Standard lengths

- 1000mm
- 2250mm
- Also available in: 250mm increments from 1000mm to 5000mm

Standard colours

- Silver anodised aluminium with grey silicone gasket/s (Black silicone gaskets also available upon request)

Fixing

- Fixing screws are supplied with detailed fitting instructions
- Fixing holes are pre-drilled to allow the seals to be positioned accurately.

Approval/s

- Conforms with BCA Specification C3.4 smoke sealing requirements
- Acoustically tested in accordance with AS1191, ISO140.3 and ISO10140-2

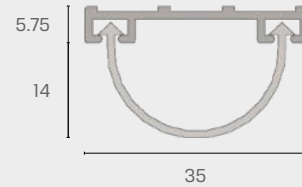

IS3020si

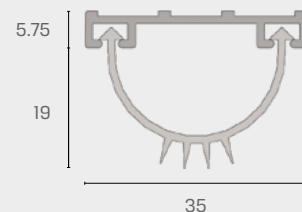

IS3021si

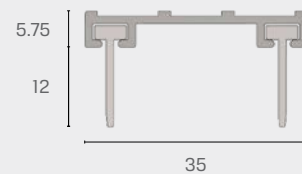

IS3022si

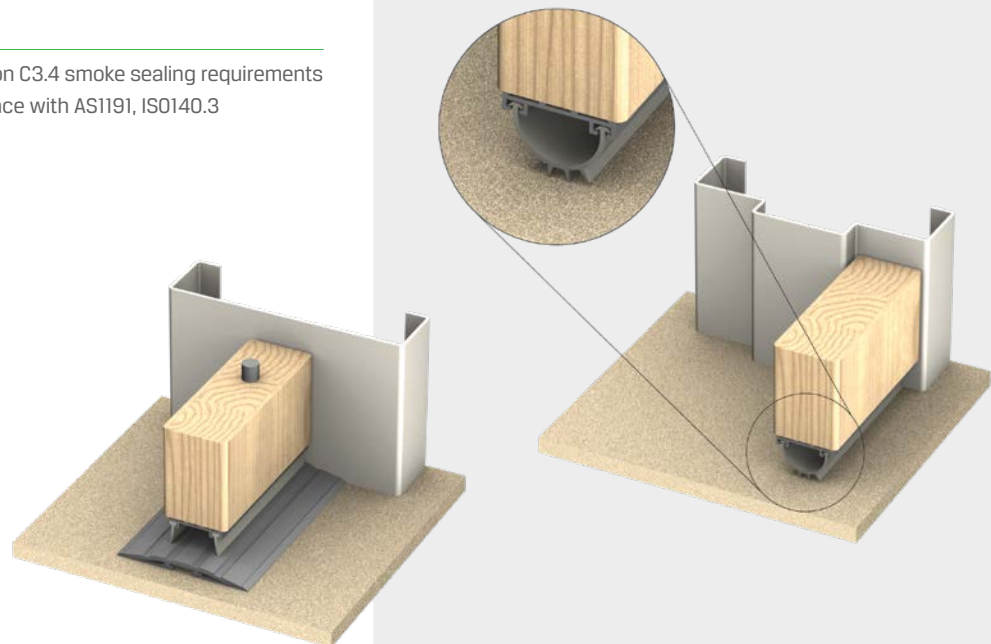

For more product information please scan QR code or visit www.kilargo.com.au/ourproducts/is3020si/



All seals proudly manufactured in Australia

IS3070si (IS3100si)



The IS3070si weather resistant door bottom seal can be fitted without removing the door, and can be used with alternative threshold plates. This seal provides effective containment against cold smoke, sound, dust, light, insects and weather. The aesthetic cover strip ensures there is no visible screw line.

The IS3100si set incorporates an IS3070si door bottom seal plus an IS4100 threshold plate.

Gap size

- Min. 12mm / max. 20mm

Standard lengths

- 1000mm
- 2250mm
- Also available in: 250mm increments from 1000mm to 5000mm

Standard colours

- Silver anodised aluminium carrier with grey silicone gasket and cover strip. (Black silicone gasket and cover strip also available upon request)

Fixing

- Fixing screws are supplied with detailed fitting instructions
- Fixing holes are pre-drilled and slotted to allow the seals to be adjusted and positioned accurately

Approval/s

- Conforms with BCA Specification C3.4 smoke sealing requirements
- Acoustically tested in accordance with AS1191, ISO140.3 and ISO10140-2

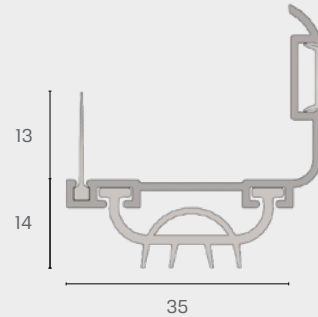
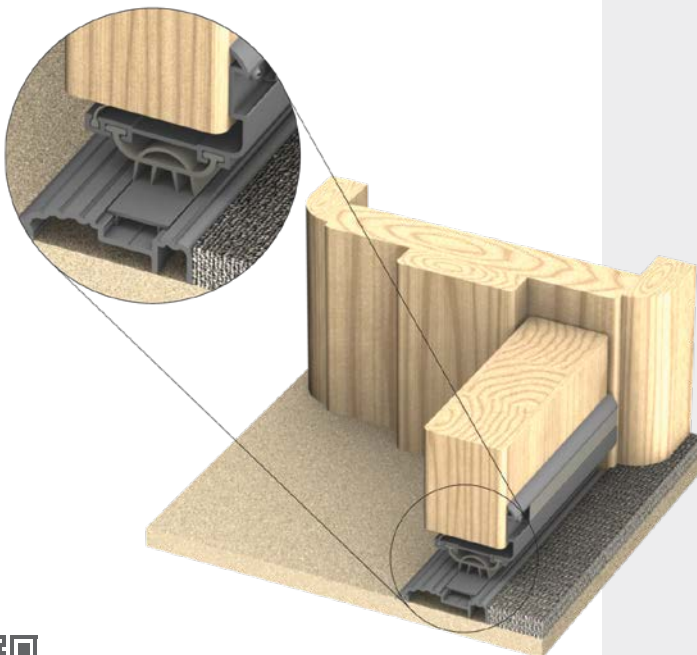

IS3070si

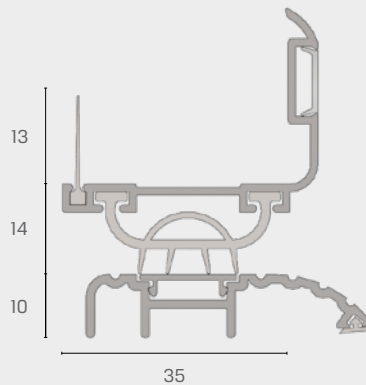
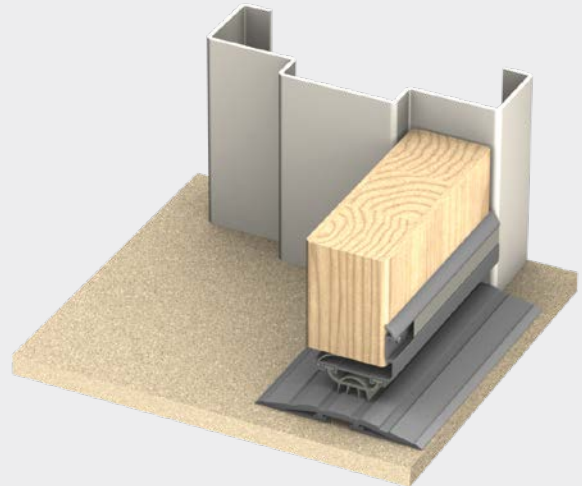

IS3100si



For more product information please scan QR code or visit www.kilargo.com.au/ourproducts/is3070si/



All seals proudly manufactured in Australia

IS3080si



The IS3080si is a sweep action blade seal with a high performance silicone rubber fin, which can be fitted to door bottoms of outward opening doors. This seal can also be utilised as a meeting stile seal for pairs of doors. This seal can provide effective containment against ambient and medium temperature smoke, sound, dust, light, insects and weather.

Standard lengths

- 1000mm
- 2250mm
- Also available in: 250mm increments from 1000mm to 5000mm

Standard colours

- Silver anodised aluminium section with grey silicone gasket and grey cover strip
- Black anodised aluminium section with black silicone gasket and black cover strip

Fixing

- Fixing screws are supplied with detailed fitting instructions
- Fixing holes are pre-drilled and slotted to allow the seals to be easily adjusted and positioned accurately on the door to suit the appropriate gap size

Approval/s

- Fire tested to AS1530 Part 4 in accordance with AS1905 Part 1
- Certifications GVY1.R26629, GVWZ.R26629, GVWZ7.R26629
- Conforms with BCA Specification C3.4 smoke sealing requirements
- Acoustically tested in accordance with AS1191, ISO140.3 and ISO10140-2



IS3080si

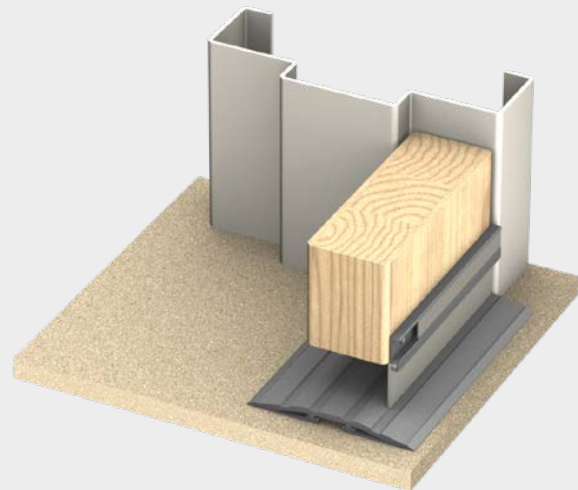

3000 Series



For more product information please scan QR code or visit www.kilargo.com.au/ourproducts/is3080si/



All seals proudly manufactured in Australia

Location: Adelaide, South Australia

Client: Government of South Australia

Architect: Silver Thomas Hanley & DesignInc

Builder: Hansen Yuncken & Leighton Contractors (HYLC Joint Venture)

Completion: 2017



The new Royal Adelaide Hospital (new RAH) will be one of Australia's most advanced hospitals and will provide all South Australians with world class healthcare.

The new RAH is larger than the existing hospital in both size and capacity with 700 overnight beds, 100 day beds, 40 specialised technical suites, multiple entry points, single rooms with ensuite bathrooms, a retail precinct, green spaces and state-of-the-art technology.

Such an advanced facility required only the very best in architectural and fire seals, with an emphasis on excellent acoustic dampening. As an experienced healthcare provider, recently working on major hospital projects in Melbourne, Perth, Sydney, Brisbane, and on the Gold Coast, Kilargo was selected to provide our rigorously tested seals for the new RAH.

The simple and smart solution

Being a state-of-the-art medical facility, the key consideration for the new RAH was infection and bacteria control plus high-end acoustics for privacy and comfort of patients and staff.

As one of the only Australian architectural seal companies with local production, Kilargo successfully designed seals for the new RAH's needs, some of which included smooth gaskets to ensure there were no areas where bacteria could hide.

Our local representative worked closely with HYLC Joint Venture and design team to ensure the high acoustic, smoke, fire & fit for purpose criteria's were achieved.

Inherent in the project brief was a specified percentage of Australian made products. As a proud local manufacturer, we were able to meet this criteria. And, with an offsite storage facility located in Adelaide, we were able to cut delivery times, helping our client meet tight project timeframes.



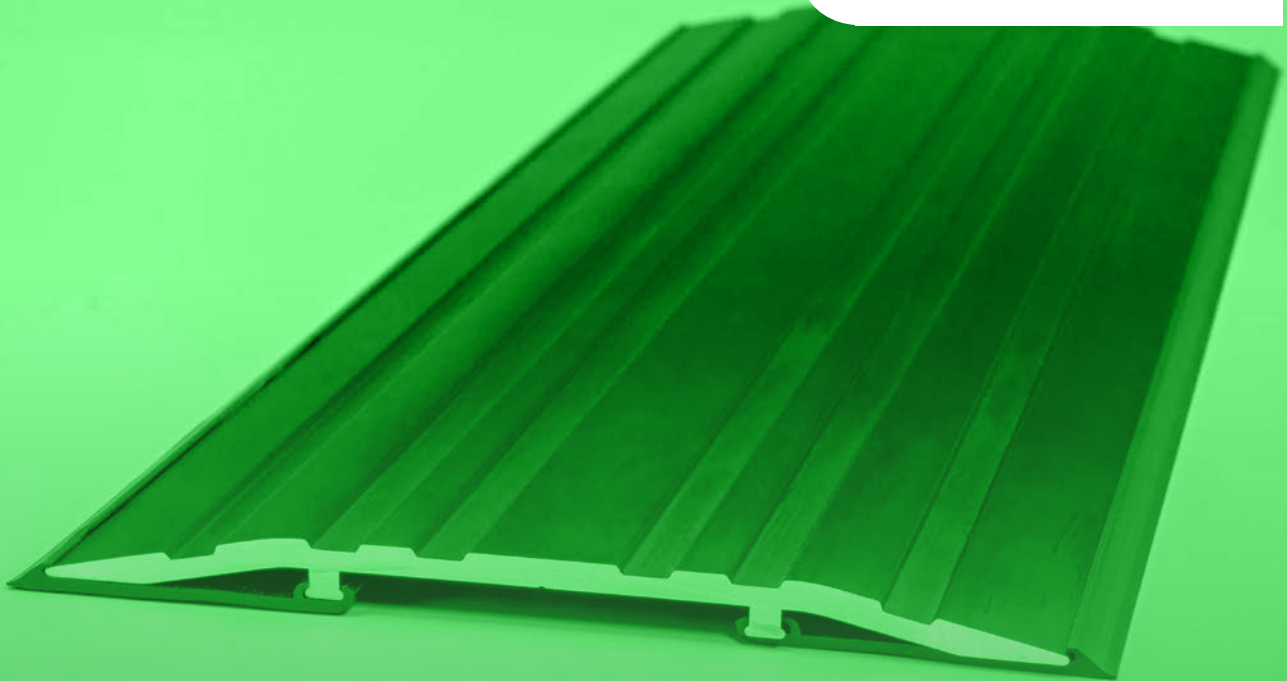

4000 SERIES

Threshold Plates & Ramps

i Threshold plates are fitted to the sill under doors providing an optimum sealing surface for door bottom seals.

Available in aluminium (and stainless steel options), threshold plates offer an elevated sealing plane, providing solutions to excessive resistance often encountered with carpeted, uneven or sloping floors. Widths from 25mm to 150mm.

IS4010, IS4015, IS4020, IS4025



These heavy duty, low profile threshold plates are used in conjunction with other Kilargo door bottom seals to help prevent rain infiltration, draught and smoke penetration. Their 6mm low profile design ensures compliance with the 'access for people with disability' requirements, AS1428/1 and NCC D2.15 & D3.3, particularly for wheelchair traffic.

These threshold plates have a durable, anodised finish and are supplied with PVC bedding pads to help eliminate vibration, noise and moisture ingress.

Standard lengths

- 1000mm
- 2250mm
- Also available in: 250mm increments from 1000mm to 5000mm

Standard colours

- Silver anodised aluminium
- Bronze anodised aluminium
- Black anodised aluminium also available for IS4015

Fixing

- Stainless Steel fixing screws and plugs are supplied
- Alternatively, fasten with builder's adhesive for concealed fixing

Approval/s

- Fire tested to AS1530 Part 4 in accordance with AS1905 Part 1
- Certifications GVI.R26629, GVWZ.R26629, GVWZ7.R26629
- Complies with AS1428 Part 1 (Design for access and mobility)
- Conforms to BCA D2.15 & D3.3 (Access for people with disabilities)

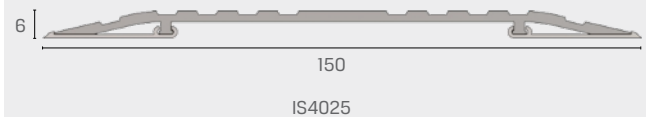
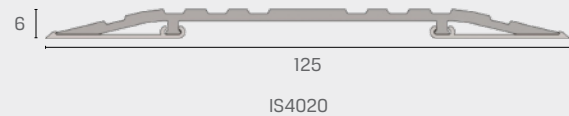
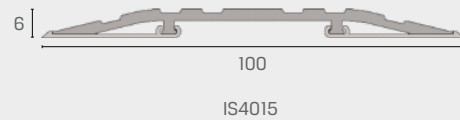

For more product information please scan QR code or visit www.kilargo.com.au/ourproducts/is4010/



All seals proudly manufactured in Australia

IS4030, IS4035, IS4040, IS4045



These heavy duty, threshold plates are used in conjunction with other Kilargo door bottom seals to help prevent rain infiltration, draught and smoke penetration.

These threshold plates have a durable, anodised finish and are supplied with PVC bedding feet to help eliminate vibration, noise and moisture ingress.

Standard lengths

- 1000mm
- 2250mm
- Also available in: 250mm increments from 1000mm to 3250mm

Standard colours

- Silver anodised aluminium

Fixing

- Stainless Steel fixing screws and plugs are supplied
- Alternatively, fasten with builder's adhesive for concealed fixing

Approval/s

- Fire tested to AS1530 Part 4 in accordance with AS1905 Part 1
- Certifications GVYL.R26629, GVWZ.R26629, GVWZ7.R26629

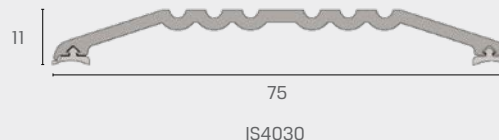

IS4030

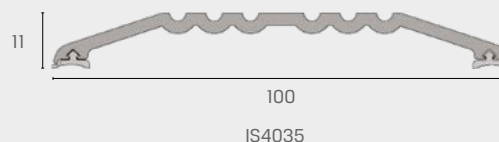

IS4035

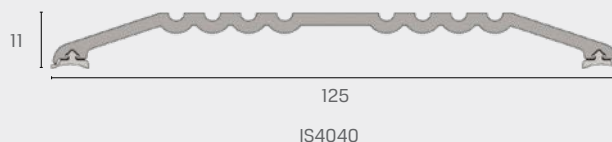

IS4040

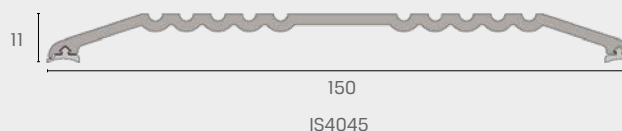

IS4045

4000 Series



For more product information please scan QR code or visit www.kilargo.com.au/ourproducts/is4030/



All seals proudly manufactured in Australia

IS4050s, IS4055s, IS4060s, IS4065s



These stainless steel threshold plates are used in conjunction with other Kilargo door bottom seals to help prevent rain infiltration, draught and smoke penetration.

These durable Grade 304 stainless steel threshold plates have a No. 4 brush finish and are impervious to most chemicals, solvents, cleaning fluids and disinfectants. They are suitable for external environments.

The IS4055S and IS4060S have a low profile design (6mm height), complying with the 'access for people with disability' requirements of AS1428/1 and NCC D2.15 & D3.3.

Standard lengths

- 1000mm
- 2250mm
- Also available in: 250mm increments from 1000mm to 3250mm

Standard colours

- Grade 304 stainless steel with No.4 brush finish

Fixing

- Appropriate stainless steel fixing screws and plugs supplied

Approval/s

- Fire tested to AS1530 Part 4 in accordance with AS1905 Part 1

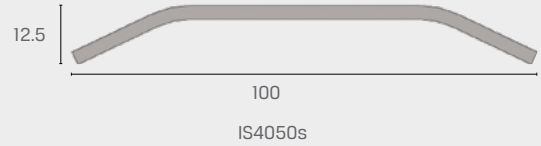

IS4050s



100



IS4055s

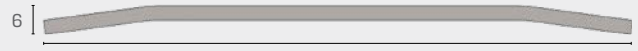

125



IS4060s

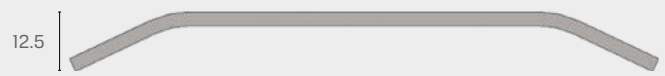

125

IS4065s

4000 Series



For more product information please scan QR code or visit www.kilargo.com.au/ourproducts/is4050s/



All seals proudly manufactured in Australia

IS4070, IS4075, IS4077, IS4078si



These threshold ramps are utilised in buildings where wheelchairs and trolleys are used or to compensate for uneven floors. Their rate of incline ensures compliance with the 'access for people with disability' requirement, particularly for wheelchair traffic.

These threshold ramps have a durable, anodised finish and are supplied with PVC bedding pads to help eliminate vibration, noise and moisture ingress.

Gradients

- IS4070 1:8
- IS4075 1:12
- IS4077 1:8
- IS4078si 1:8

Standard lengths

- 1000mm
- 2250mm
- Also available in: 250mm increments from 1000mm to 5000mm

Standard colours

- Silver anodised aluminium

Fixing

- Stainless steel fixing screws and plugs supplied
- These extrusions can be positioned back-to-back to provide a two-way threshold ramp

Approval/s

- Fire tested to AS1530 Part 4 in accordance with AS1905 Part 1
- Certifications GVI.R26629, GVWZ.R26629, GVWZ7.R26629
- Complies with AS1428 Part 1 (Design for access and mobility)
- Conforms to BCA D2.15 & D3.3 (Access for people with disabilities)

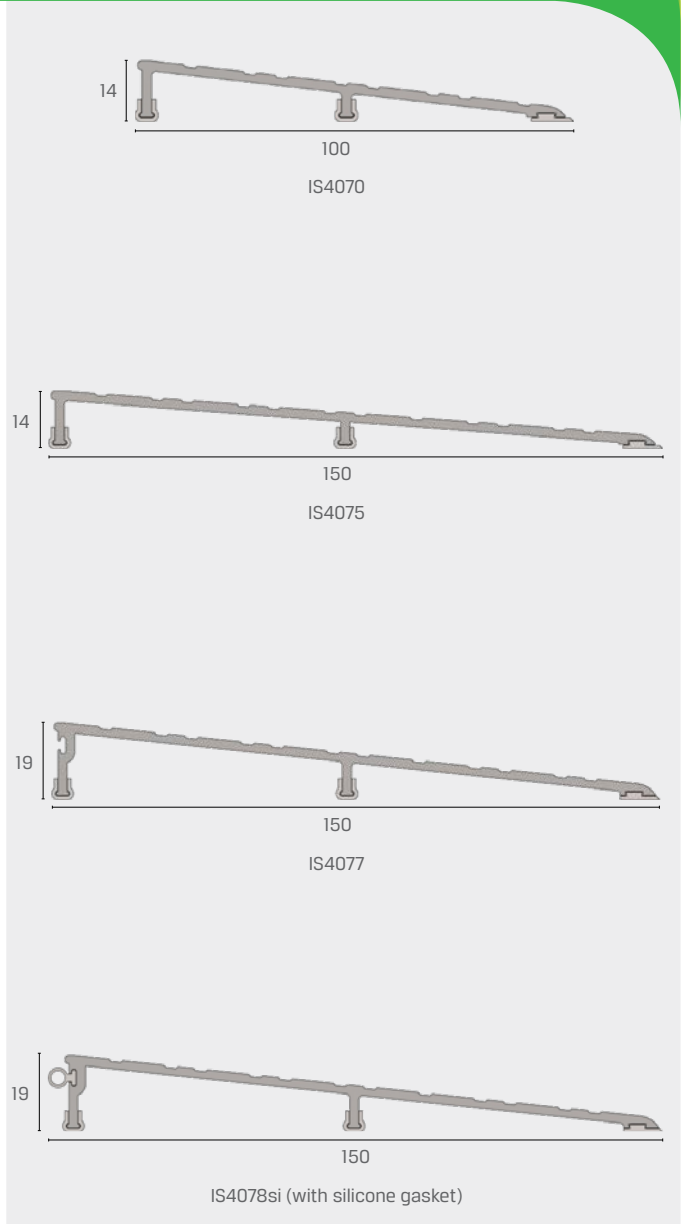

4000 Series



For more product information please scan QR code or visit www.kilargo.com.au/ourproducts/is4070/



All seals proudly manufactured in Australia

IS4080, IS4100



The IS4080 threshold ramp is designed for use in buildings as a door sill, providing a neat detail between internal carpet or tiles at doorways. This seal is supplied with PVC bedding pads to assist in eliminating vibration and noise.

The IS4100 threshold plate is used to prevent rain, draughts, light and vermin penetration. It is used in conjunction with the IS3070si door bottom seal. This threshold plate has a durable, anodised finish with a snap-fit cover strip for concealed fixings. It is supplied with a vinyl insert to help prevent moisture ingress under the threshold.

Standard lengths

- 1000mm
- 2250mm
- Also available in: 250mm increments from 1000mm to 5000mm

Standard colours

- Silver anodised aluminium

Fixing

- Stainless steel fixing screws and plugs supplied

Approval/s

- Fire tested to AS1530 Part 4 in accordance with AS1905 Part 1
- Certifications GVI1.R26629, GVWZ.R26629, GVWZ7.R26629

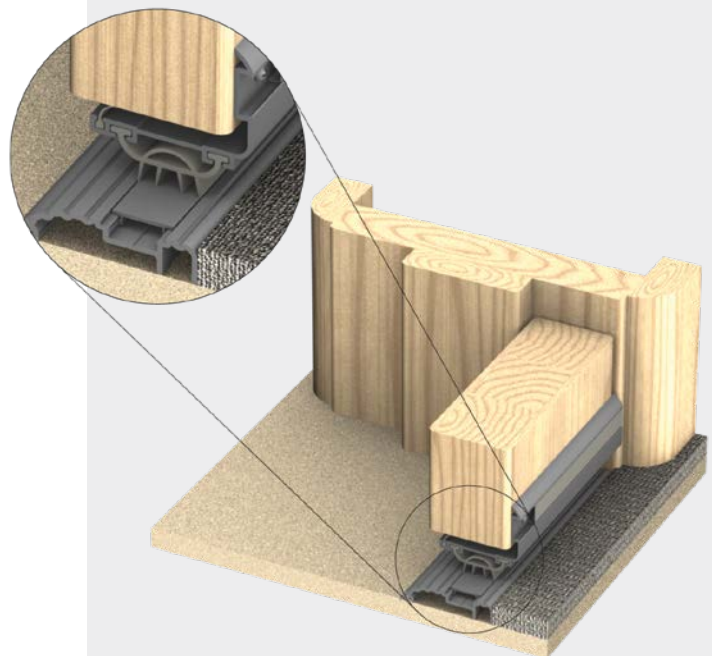
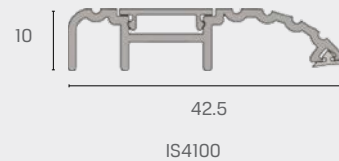
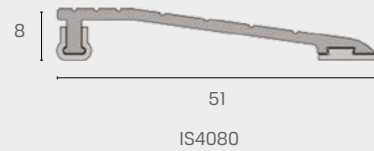

For more product information please scan QR code or visit www.kilargo.com.au/ourproducts/is4080/



All seals proudly manufactured in Australia

IS4110, IS4120, IS4130



The IS4110, IS4120 and IS4130 threshold plates are used in conjunction with other Kilargo door bottom seals to help prevent rain, draughts, and smoke penetration. Their low profile ensures compliance with the 'access for people with disability' requirements, particularly for wheelchair traffic.

Standard lengths

- 1000mm
- 2250mm
- Also available in: 250mm increments from 1000mm to 5000mm

Standard colours

- Silver anodised aluminium

Fixing

- Stainless steel fixing screws and plugs supplied
- Alternatively, fasten with builder's adhesive for concealed fixing

Approval/s

- Fire tested to AS1530 Part 4 in accordance with AS1905 Part 1
- Certifications GVI.R26629, GVWZ.R26629, GVWZ7.R26629
- Complies with AS1428 Part 1 (Design for access and mobility)
- Conforms to BCA D2.15 & D3.3 (Access for people with disabilities)

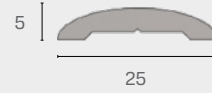

IS4110



IS4120

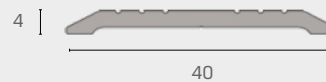

IS4130

4000 Series



For more product information please scan QR code or visit www.kilargo.com.au/ourproducts/is4110/



All seals proudly manufactured in Australia

IS4135

The IS4135 threshold plate/stair nosing is suitable for uneven or raised door sills to help prevent rain, draughts, and light penetration, when used in conjunction with a Kilargo door bottom seal.

Standard lengths

- 1000mm
- 2250mm
- Also available in: 250mm increments from 1000mm to 5000mm

Standard colours

- Silver anodised aluminium

Fixing

- Stainless steel fixing screws and plugs supplied
- Alternatively, fasten with builder's adhesive for concealed fixing



For more product information please scan QR code or visit www.kilargo.com.au/ourproducts/is4135/

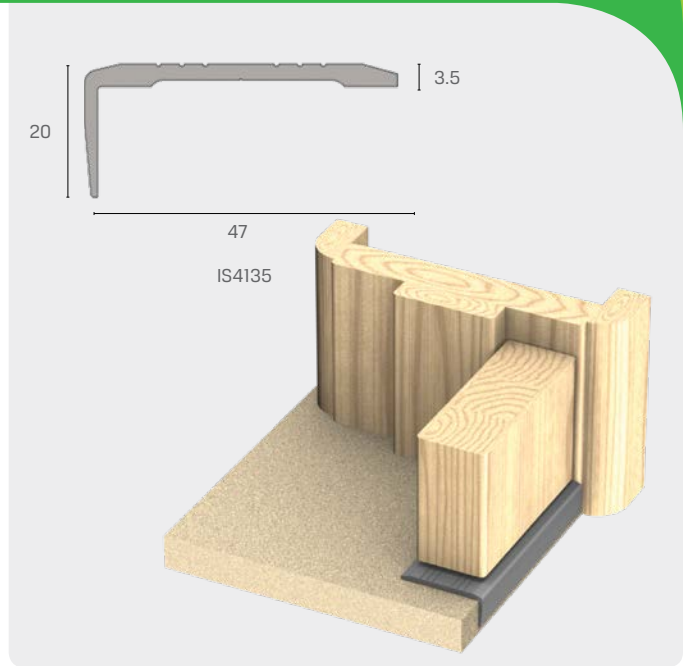

IS4140



The IS4140 threshold plate is used when a flat sealing surface is required where carpet runs under the door. It is used in conjunction with other Kilargo door bottom seals to help prevent draught, insect and smoke penetration.

Their low profile ensures compliance with the 'access for people with disability' requirements, particularly for wheelchair traffic. The durable, anodised profile has a snap-fit cover strip for concealed fixings.

Standard lengths

- 1000mm
- 2250mm
- Also available in: 250mm increments from 1000mm to 5000mm

Standard colours

- Silver anodised aluminium

Fixing

- Stainless steel fixing screws and plugs supplied

Approval/s

- Fire tested to AS1530 Part 4 in accordance with AS1905 Part 1
- Certifications GVI1.R26629, GVWZ.R26629, GVWZ7.R26629
- Complies with AS1428/1 (Design for access and mobility)
- Conforms to BCA D2.15 & D3.3 (Access for people with disabilities)



For more product information please scan QR code or visit www.kilargo.com.au/ourproducts/is4140/

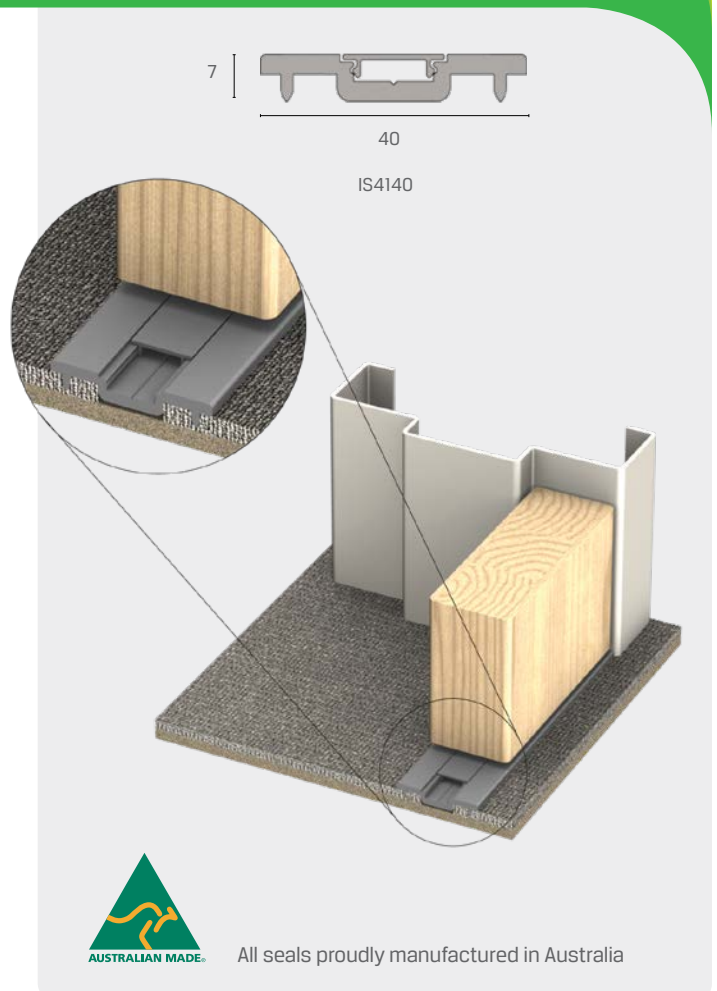

All seals proudly manufactured in Australia

IS4220si



The IS4220si threshold plate is suitable for outward opening doors to prevent rain, draughts, light and noise penetration. The high performance silicone rubber compression seal, combined with the vinyl bedding pads, help provide an effective acoustic barrier.

May be used with a panic type exit device (supplied to suit by others).

Standard lengths

- 1000mm
- 2250mm
- Also available in: 250mm increments from 1000mm to 5000mm

Standard colours

- Silver anodised aluminium with grey silicone rubber gasket (Black silicone gaskets also available upon request)

Fixing

- Stainless Steel fixing screws and plugs are supplied

Approval/s

- Fire tested to AS1530 Part 4 in accordance with AS1905 Part 1
- Certifications GVI.R26629, GVWZ.R26629, GVWZ7.R26629
- Acoustically tested in accordance with AS1191, ISO140.3 and ISO10140-2

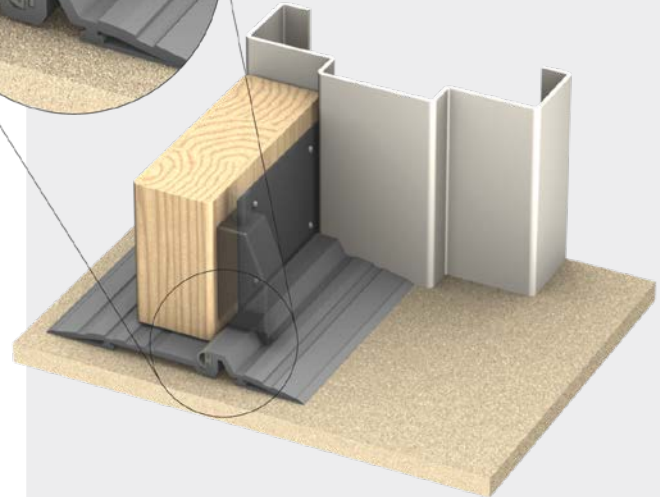
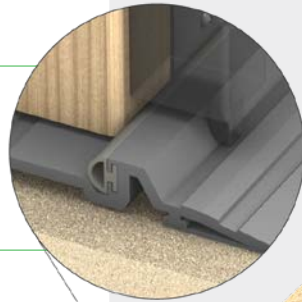

4000 Series



For more product information please scan QR code or visit www.kilargo.com.au/ourproducts/is4220si/



All seals proudly manufactured in Australia

IS4226si



The IS4226si threshold plate and seal is suitable for outward opening doors to help prevent weather, smoke, light and noise penetration. The plate has an extended landing area, ideal for high-end acoustic applications (when used with other sealing combinations).

It may be used with panic type exit devices (supplied by others).

Standard lengths

- 1000mm
- 2250mm
- Also available in: 250mm increments from 1000mm to 5000mm

Standard colours

- Silver anodised aluminium with grey silicone rubber gasket (Black silicone gaskets also available upon request)

Fixing

- Stainless Steel fixing screws and plugs are supplied

Approval/s

- Acoustically tested in accordance with AS1191, ISO140.3 and ISO10140-2

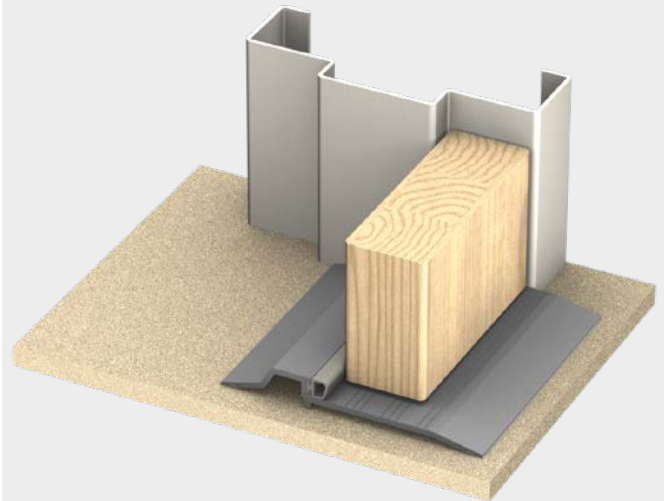
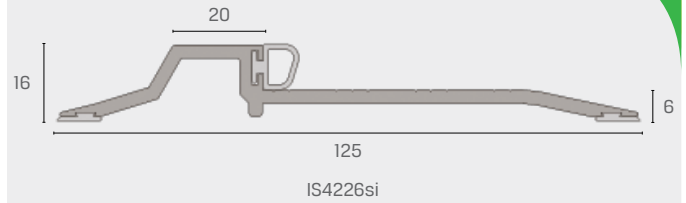

For more product information please scan QR code or visit www.kilargo.com.au/ourproducts/is4226si/



All seals proudly manufactured in Australia



5000 SERIES

Sweep Action Seals

-  These nylon brush filament and silicone blade type seals provide alternative sealing solutions to many difficult-to-seal door configurations, such as double swing leaves, sliding, revolving and roller shutter doors.

IS5110, IS5115, IS5120, IS5130



These brush seals are designed to be used around the head & jambs, door bottom and meeting stiles of single or double swing doors, revolving, tilt-up and roller doors. These seals help protect against draught and dust, insects and weather penetration.

The slim-line carriers are aesthetically angled to avoid dust build-up.

The black nylon brush filaments, which are locked into a galvanized steel strip, are available fitted to an aluminium carrier, or as brush only.

Standard lengths

- 1000mm
- 2250mm
- Also available in: 250mm increments from 1000mm to 3000mm

Standard colours

- Silver anodised aluminium carrier with black nylon brush
- Black anodised aluminium carrier with black nylon brush

Fixing

- Brush seals (within carriers) can be screw-fixed or self-adhered to the desired surface
- Fixing screws and aggressive backing tape are supplied
- Brush only seals can be mortised into a nominal 3mm (w) x 4mm (d) groove (with the length slightly kinked for an interference fit)

Approval/s

- Durability tests demonstrating over 100,000 open & close cycles

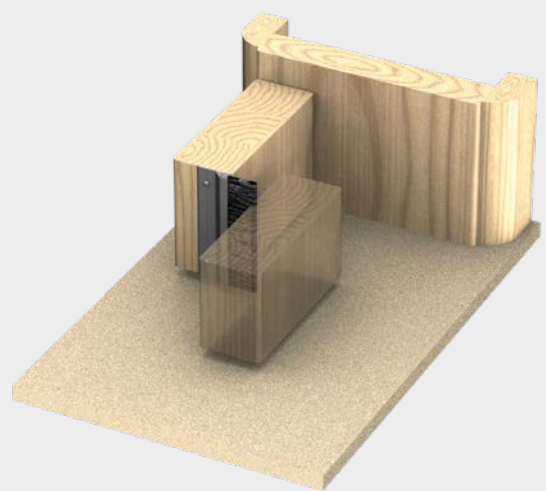
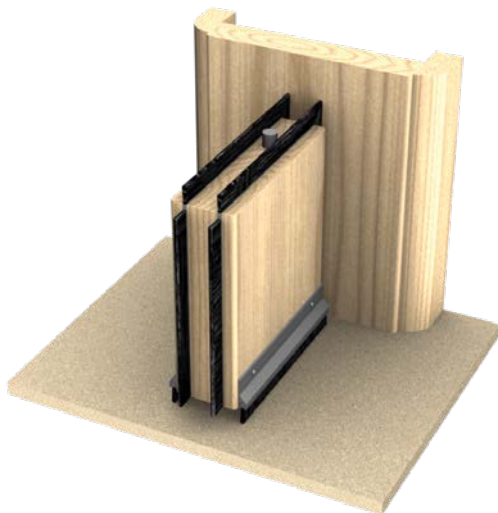

For more product information please scan QR code or visit www.kilargo.com.au/ourproducts/is5110/



All seals proudly manufactured in Australia

IS5111si, IS5116si, IS5121si



These silicone sweep seals are designed to be used around the head and jambs, door bottom and meeting stiles of single or double swing doors, revolving, tilt-up and roller doors. These seals help protect against ambient and medium temperature smoke, draught and dust, and weather penetration. The slim line carriers are aesthetically angled to avoid dust build-up. These seals provide excellent sealing solutions for pivot action smoke doors and clean room applications.

Gap size

- IS5111si: Min. 9mm / max. 12mm
- IS5116si: Min. 12mm / max. 19mm
- IS5121si: Min. 19mm / max. 24mm

Standard lengths

- 1000mm
- 2250mm
- Also available in: 250mm increments from 1000mm to 5000mm

Standard colours

- Silver anodised aluminium carrier with grey silicone fin
- Black anodised aluminium carrier with black silicone fin

Fixing

- Silicone sweep seals (within carriers) can be screw-fixed or self-adhered to the desired surface
- Fixing screws and aggressive backing tape are supplied

Approval/s

- Fire tested to AS1530 Part 4 in accordance with AS1905 Part 1
- Medium temperature smoke leakage approvals to AS1530 Part 7, compliant with AS6905 on proprietary door assemblies for IS5111si
- Conforms with BCA Specification C3.4 smoke sealing requirements
- Acoustically tested in accordance with AS1191, ISO140.3 & ISO10140-2

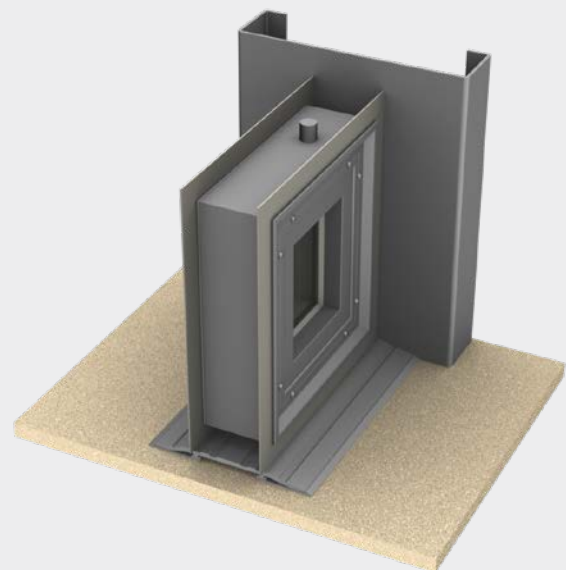
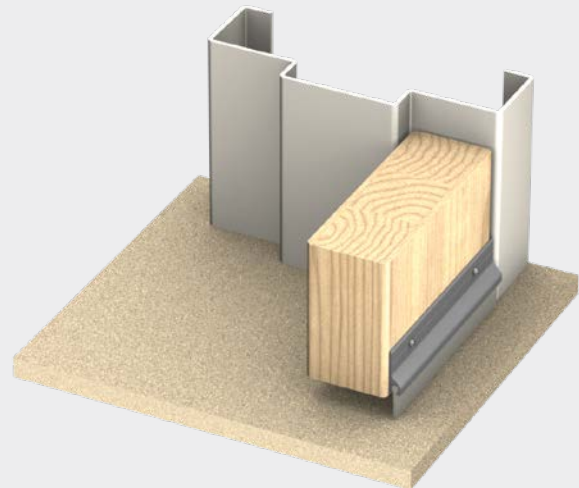
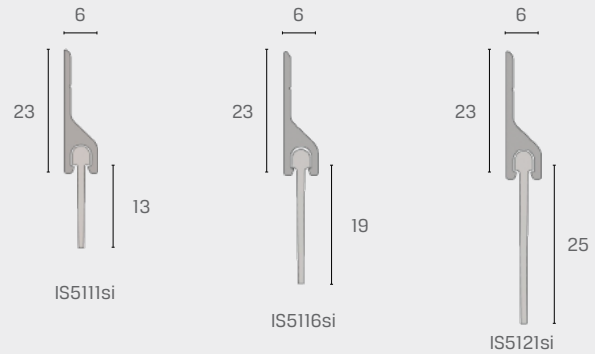

5000 Series



For more product information please scan QR code or visit www.kilargo.com.au/ourproducts/is5111si/



All seals proudly manufactured in Australia

IS5160H, IS5175A



The IS5160H seal is designed with a 90° angle aluminium carrier and is used to prevent draught and dust penetration on sliding doors.

The IS5175A seal is designed with a 45° angle aluminium carrier and is used to prevent draught and dust penetration around the perimeter of roller and tilt-up doors.

The angled aluminium carriers can be fitted with either 13mm, 19mm or 25mm black nylon brush. (50mm brush is also available upon request).

Gap size

- IS5160H: Min. 23mm / max. 29mm (with 25mm brush insert)
- IS5175A: Min. 15mm / max. 21mm (with 19mm brush insert)
(Gap size dependent upon brush size utilised.)

Standard lengths

- 1000mm
- 2250mm
- Also available in: 250mm increments from 1000mm to 3000mm
(Brush lengths to be confirmed upon placement of order.)

Standard colours

- Silver anodised aluminium carrier with black nylon brush

Fixing

- Brush seals (within carriers) can be screw fixed or self-adhered to the desired surface
- Fixing screws and aggressive backing tape are supplied

Approval/s

- Durability tests demonstrating over 100,000 open and close cycles

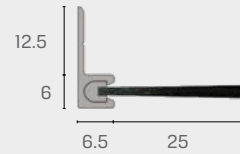

IS5160H

(Shown with 25mm brush insert)

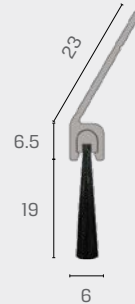

IS5175A

(Shown with 19mm brush insert)

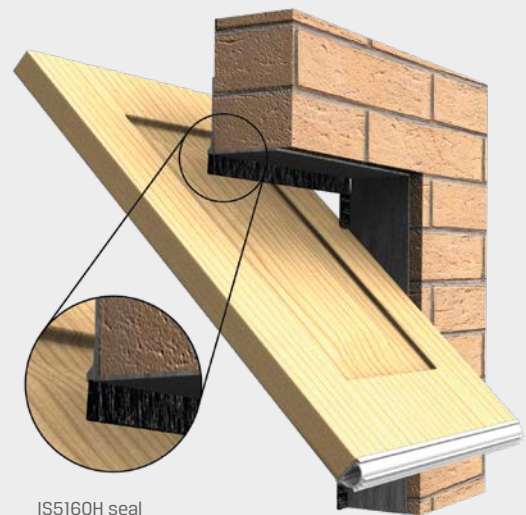

IS5160H seal

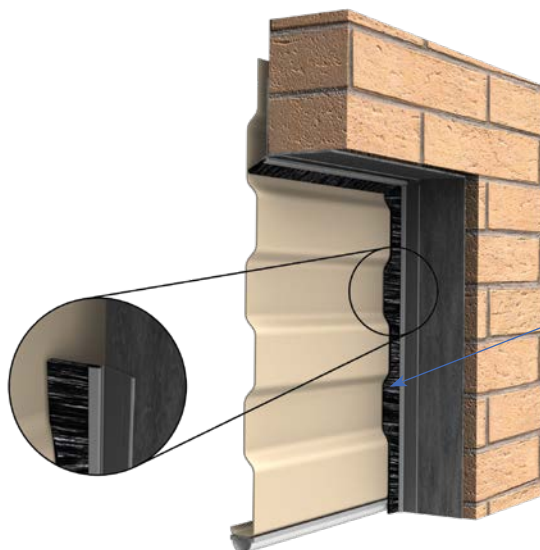

IS5175A seal



For more product information please scan QR code or visit www.kilargo.com.au/ourproducts/is5160h/



All seals proudly manufactured in Australia

IS5161Hsi, IS5176Asi, IS5177Asi



These silicone sweep seals are all utilised to prevent ambient/ medium temperature smoke, draught and dust penetration. The IS5161Hsi is designed with a 90° angle aluminium carrier for use on sliding doors. The IS5176Asi seal is designed with a 45° angle aluminium carrier and is used around the perimeter of roller and tilt-up doors. The IS5177Asi seal has an angled silicone gasket and can be utilised around perimeters of automatic pivot and sliding doors to good effect. The IS5161Hsi and IS5176Asi aluminium carriers can both be fitted with either a 13mm, 19mm or 25mm silicone fin.

Standard lengths

- 1000mm
- 2250mm
- Also available in: 250mm increments from 1000mm to 5000mm (Fin lengths to be confirmed upon placement of order.)

Standard colours

- Silver anodised aluminium carrier with grey silicone fin (Black silicone fins are also available upon request)

Fixing

- Silicone sweep seals (within carriers) can be screw-fixed or self-adhered to the desired surface
- Fixing screws and aggressive backing tape are supplied

Approvals

- Medium temperature smoke leakage approvals to AS1530 Part 7, compliant with AS6905 on proprietary door assemblies
- Conforms with BCA Specification C3.4 smoke sealing requirements
- Acoustically tested in accordance with AS1191, IS0140.3 and IS010140-2

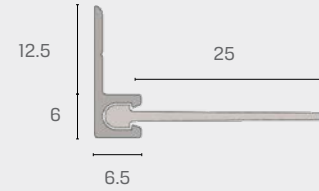
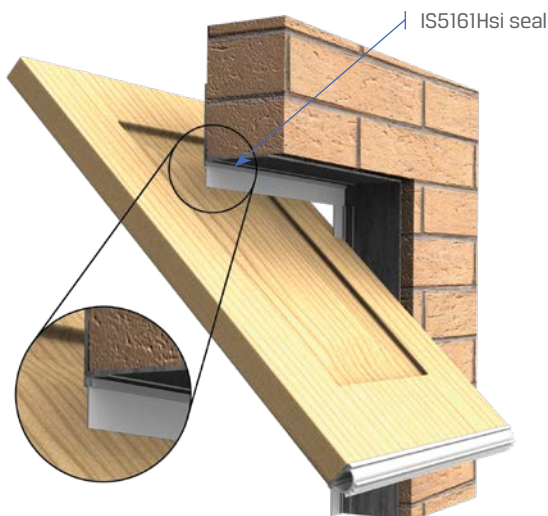

IS5161Hsi
(Shown with 25mm silicone fin insert)

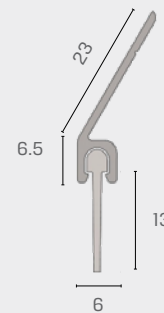

IS5176Asi
(Shown with 13mm silicone fin insert)

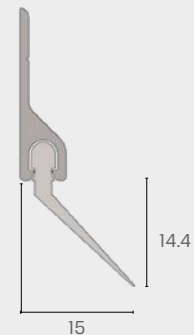

IS5177Asi

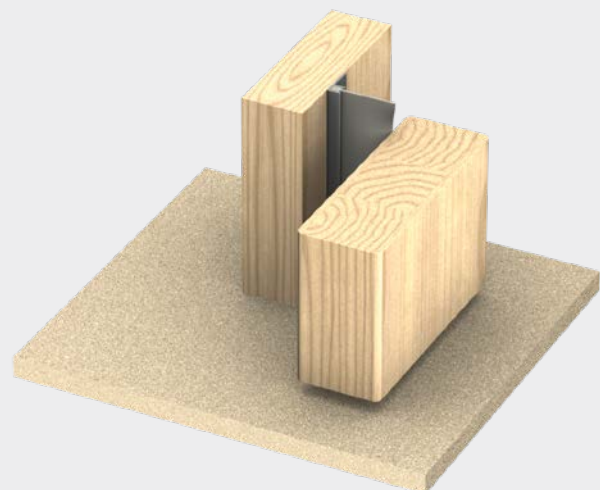

For more product information please scan QR code or visit www.kilargo.com.au/ourproducts/is5161hsi/



All seals proudly manufactured in Australia

Location:	Adelaide, South Australia
Client:	Government of South Australia
Architect:	Cox Architecture, Hames Sharley & Walter Brooke
Builder:	Lend Lease
Completion:	2014



This \$560 million redevelopment of an internationally renowned, inner-city stadium combined contemporary design with its famous heritage – including retaining the original scoreboard and many established Moreton Bay figs as features.

With seating capacity of 50,000, the new development includes dining spaces to cater for 2,000 and a new footbridge across the River Torrens. The project commenced in early 2012 and was completed in March 2014.

This world-class stadium was delivered in just 100 weeks, a delivery program that's unprecedented anywhere in the southern hemisphere.

The simple and smart solution

This iconic Australian landmark called for Australian made products. Kilargo was thrilled to work with our project partners to deliver locally manufactured fire, smoke and acoustic seals to the Adelaide Oval.

With over 600 proprietary fire doors incorporating smoke and acoustics properties, public safety and comfort was imperative. In consultation with the project partners, Kilargo intumescent seals were specified in combination with perimeter seals to achieve the highest possible fire protection. Manufactured uniquely by Kilargo, these seals meet mandatory building regulations throughout Australia.

The seals used also had the added advantage of providing superior acoustic protection throughout the many meeting, function and club dressing rooms.



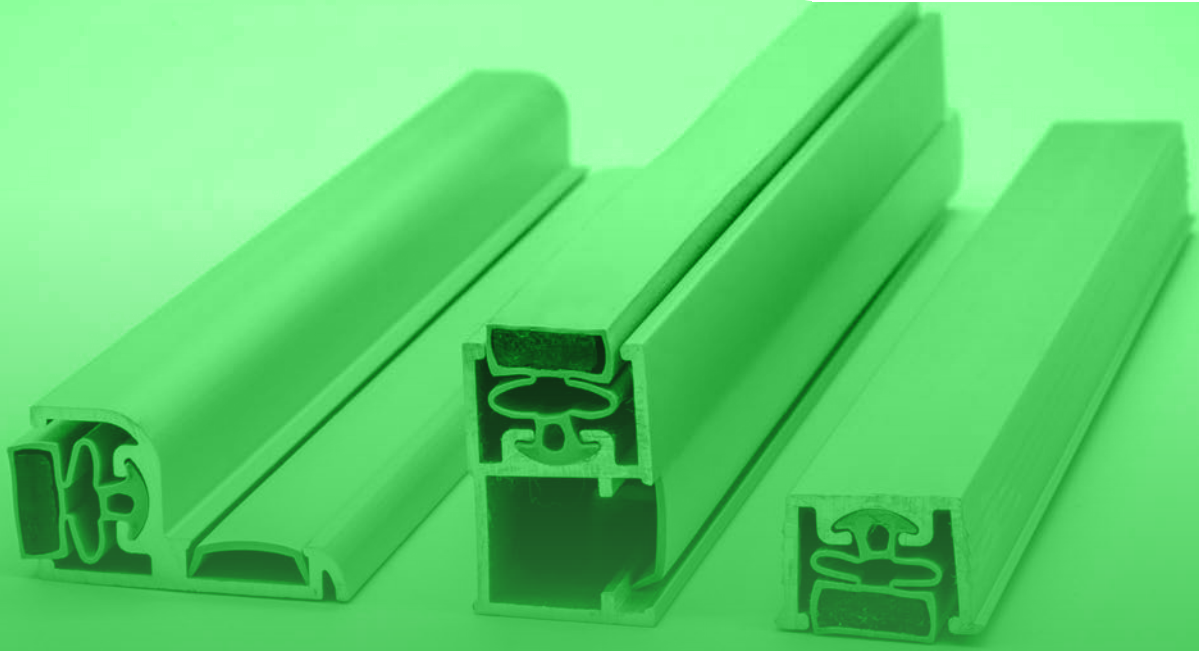

6000 SERIES

Magnetic Seals



A range of perimeter seals fitted with gaskets incorporating a strip magnet that, when attracted to opposing magnetic surfaces, extends to form a positive seal.

IS6015



The IS6015 magnetic seal is designed to be fitted to the head and jamps of metal clad door perimeters. Can be used in lieu of door stops.

This seal has sufficient magnetic strength so that latches may not be required.

Note: When ordering this seal for meeting stile applications, please specify the seals as PAIRS. This will ensure the correct orientation of the magnets, as correct polarity alignment is critical to this function.

Standard lengths

- 1000mm
- 2250mm
- Also available in: 250mm increments from 1000mm to 3000mm

Standard colours

- Silver anodised aluminium with grey gasket and cover strip (Black gasket and cover strip also available upon request)

Approval/s

- Acoustically tested in accordance with AS1191, ISO140.3 and ISO10140-2

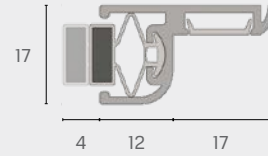

IS6015

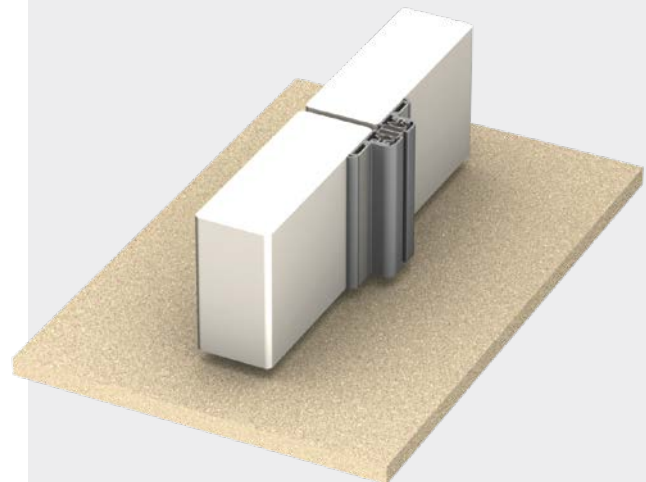
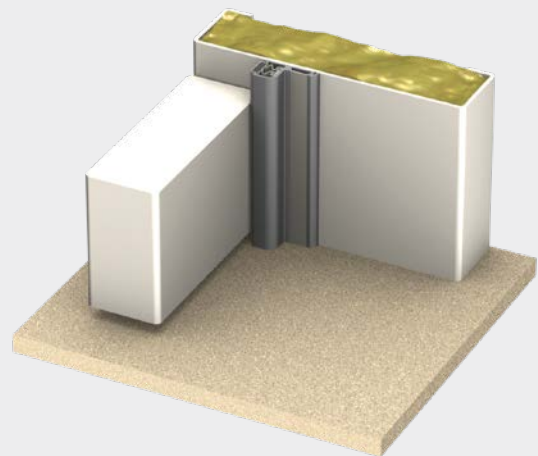

For more product information please scan QR code or visit www.kilargo.com.au/ourproducts/is6015/



All seals proudly manufactured in Australia

IS6020



The IS6020 magnetic seal is designed to be fitted to existing timber door leaves on double swing doors and sliding door meeting stiles.

This seal has sufficient magnetic strength that latches may not be required. The aluminium carrier is toothed and splayed to lock into a 16.5mm x 12mm groove to prevent any 'creeping'.

Standard lengths

- 1000mm
- 2250mm
- Also available in: 250mm increments from 1000mm to 3000mm

Standard colours

- Silver anodised aluminium with grey magnetic gasket (Black gaskets also available upon request)

Approval/s

- Acoustically tested in accordance with AS1191, ISO140.3 and ISO10140-2

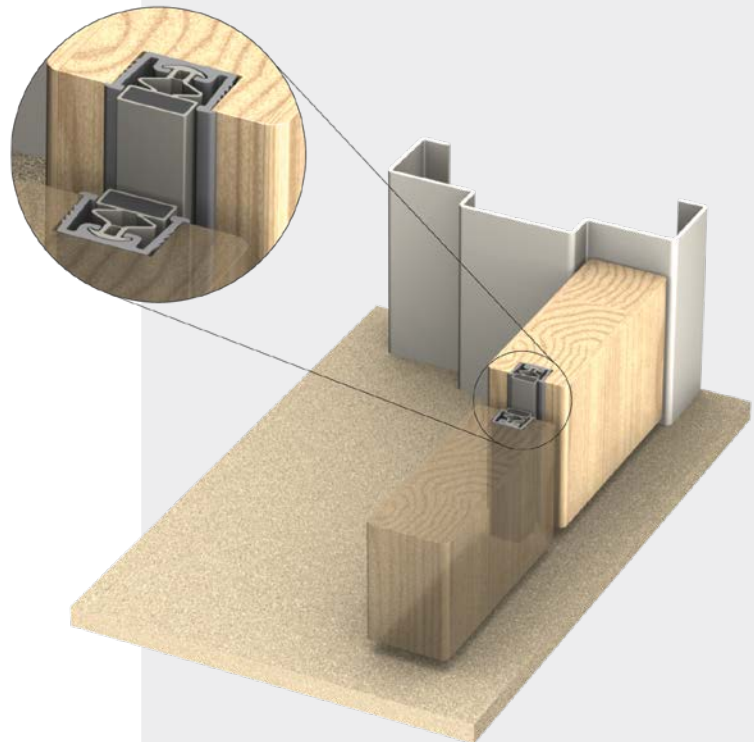
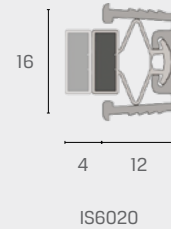

6000 Series



For more product information please scan QR code or visit www.kilargo.com.au/ourproducts/is6020/



All seals proudly manufactured in Australia

IS6030



The IS6030 compact magnetic seal is designed to be fitted to the head and jambs of metal clad door perimeters in lieu of door stops. This refrigeration-type magnetic seal has sufficient magnetic strength that latches may not be required.

Standard lengths

- 1000mm
- 2250mm
- Also available in: 250mm increments from 1000mm to 3000mm

Standard colours

- Silver anodised aluminium with grey gasket and cover strip (Black gasket and cover strip also available upon request)

Approval/s

- Acoustically tested in accordance with AS1191, ISO140.3 and ISO10140-2

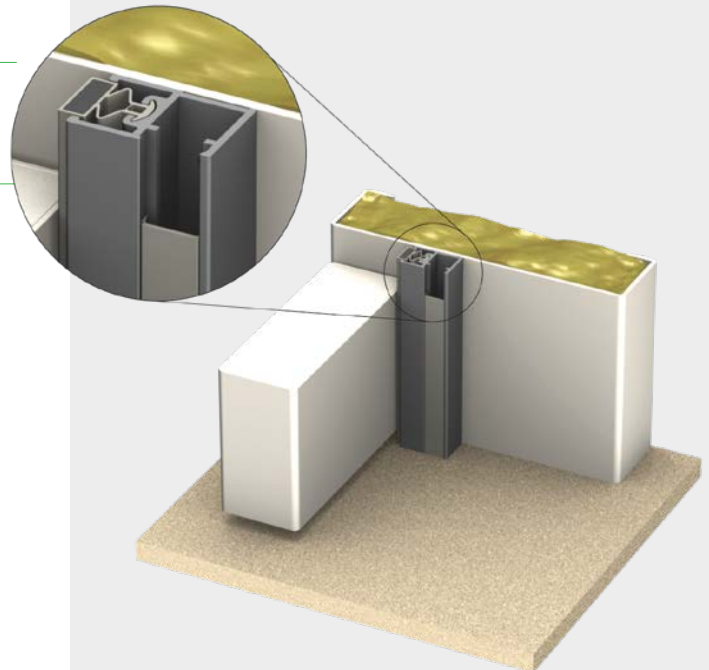
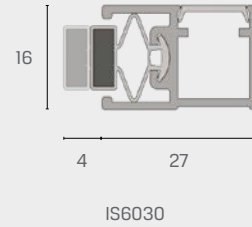

For more product information please scan QR code or visit www.kilargo.com.au/ourproducts/is6030/



All seals proudly manufactured in Australia



7000 SERIES

Perimeter Seals

-  A comprehensive range of perimeter seals designed to fit around the head, jambs and meeting stiles of doors, providing an effective barrier to noise, smoke, weather and draughts.

IS7010si, IS7020si



The IS7010si and IS7020si are aesthetically designed, slim-line compression type perimeter seals for installation around the head and jambs of single swing doors. They are proven to be effective acoustic, smoke, light, dust and weather seals.

The aluminium carrier is pre-drilled and slotted for adjustable retrofit installation. The easy to install, "snap-on", anodised aluminium cover plates provide concealed fixings.

Gap size

- Min. 0mm / max. 6mm

Door set standard lengths

- Single: 1 x 1000mm, 2 x 2100mm
- Long Single: 1 x 1000mm, 2 x 2750mm
- Double: 3 x 2100mm
- Long Double: 1 x 2100mm, 2 x 2750mm

Standard lengths

- 1000mm
- 2250mm

Also available in individual lengths:

- 250mm increments from 1000mm to 5000mm

Standard colours

- Silver anodised aluminium with grey silicone gasket (Black silicone gaskets also available upon request)

Fixing

- When fixing IS7020si to rebated frames of single doors, specify a long back set door latch

* Kilargo does not recommend the installation of profiles with 'snap-on' aluminium cover plates for aluminium door / frame systems.

Approval/s

- Fire tested to AS1530 Part 4 in accordance with AS1905 Part 1
- Certifications GYI.R26629, GVWZ.R26629, GVWZ7.R26629
- Medium temperature smoke leakage approvals to AS1530 Part 7, compliant with AS6905 on proprietary door assemblies
- Acoustically tested in accordance with AS1191, IS0140.3 and IS010140-2

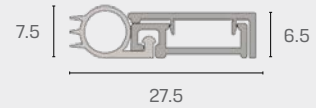

IS7010si



IS7020si

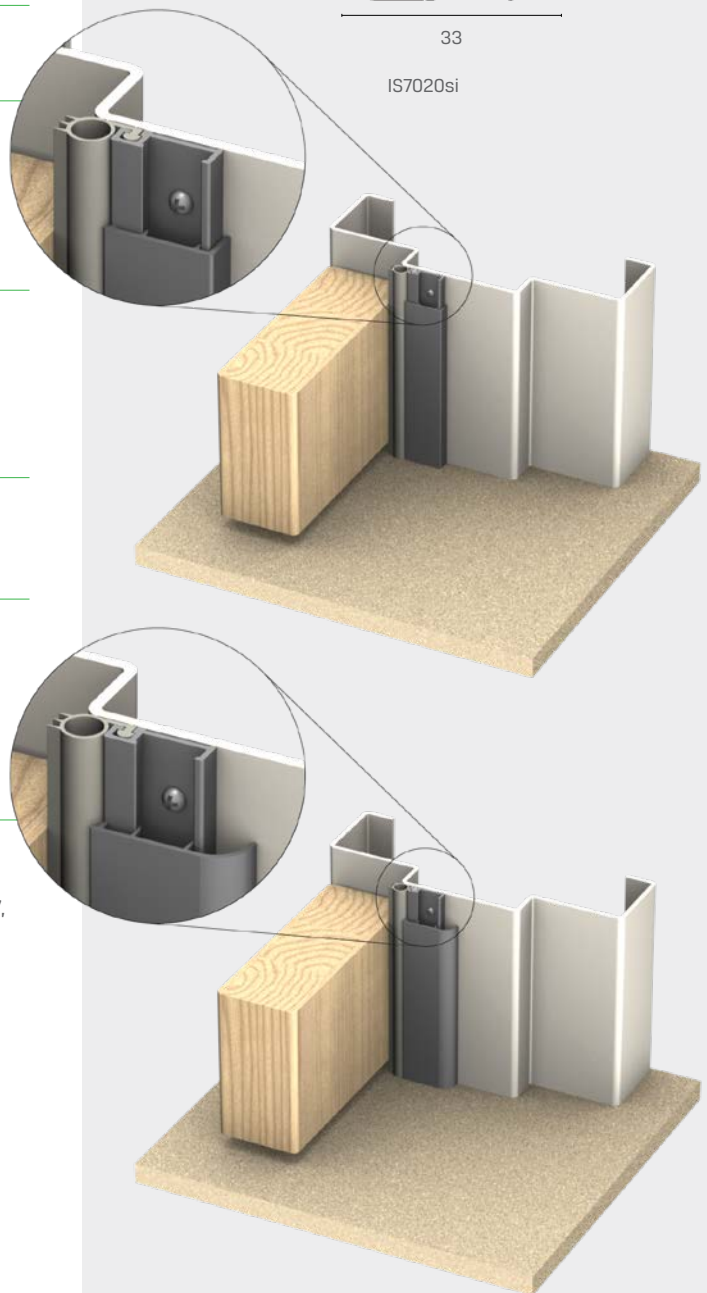

7000 Series



For more product information please scan QR code or visit www.kilargo.com.au/ourproducts/is7010si/



All seals proudly manufactured in Australia

IS7025si



The IS7025si is a popular slim-line, door frame perimeter seal, designed to be fitted to an existing door stop, around the head and jambs of single swing doors.

The aluminium carrier has fixing holes pre-drilled and slotted to allow the seals to be adjusted and positioned accurately. A decorative cover strip is supplied to conceal these fixings.

Gap size

- Min. 0mm / max. 6mm

Door set standard lengths

- Single: 1 x 1000mm, 2 x 2100mm
- Long Single: 1 x 1000mm, 2 x 2750mm
- Double: 3 x 2100mm
- Long Double: 1 x 2100mm, 2 x 2750mm

Standard lengths

- 1000mm
- 2250mm
- Also available in: 250mm increments from 1000mm to 5000mm

Standard colours

- Silver anodised aluminium with grey silicone gasket and grey cover strip
- Black anodised aluminium with black silicone gasket and black cover strip

Approval/s

- Fire tested to AS1530 Part 4 in accordance with AS1905 Part 1
- Certifications GVV1.R26629, GVWZ.R26629, GVWZ7.R26629
- Acoustically tested in accordance with AS1191, ISO140.3 & ISO10140-2

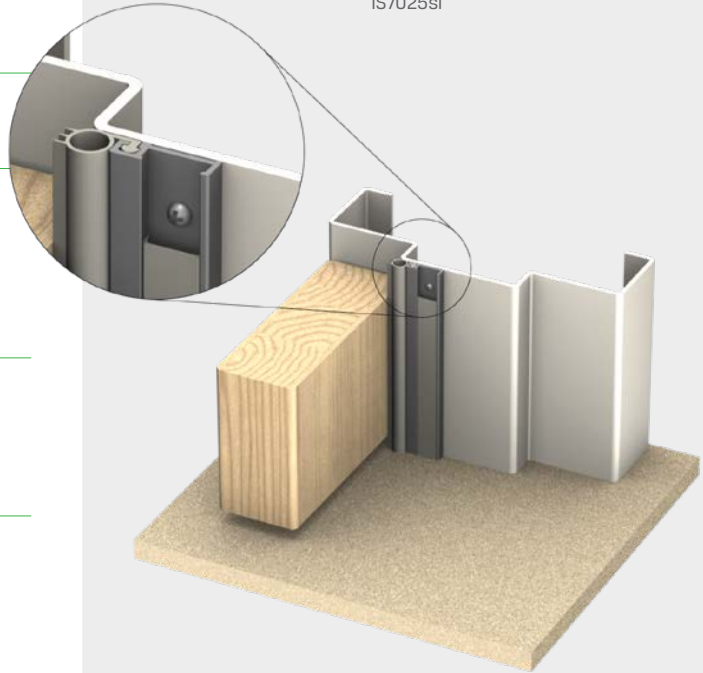
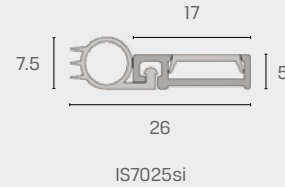

For more product information please scan QR code or visit www.kilargo.com.au/ourproducts/is7025si/



All seals proudly manufactured in Australia

IS7060si



An astragal seal used with either plain or rebated meeting stiles on single swing, double doors (where only one door leaf is active). It provides an excellent acoustic, smoke, light, dust and weather seal.

The thin fixing leg allows this seal to be face fixed to the door (no rebating required). This leg can also be checked to make way for locks and latches.

Gap size

- Min. 2.5mm / max. 10mm

Standard lengths

- 2250mm
- 3000mm
- Also available in: 250mm increments from 2000mm to 3500mm

Standard colours

- Silver anodised aluminium with grey silicone gasket
- Black anodised aluminium with black silicone gasket

Fixing

- A door sequence selector should be considered unless one leaf is intended to be fixed

Approval/s

- Medium temperature smoke leakage approvals to AS1530 Part 7, compliant with AS6905 on proprietary door assemblies.
- Conforms with BCA Specification C3.4 smoke sealing requirements.
- Acoustically tested in accordance with AS1191, ISO140.3 and ISO10140-2.

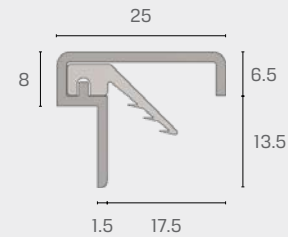

IS7060si

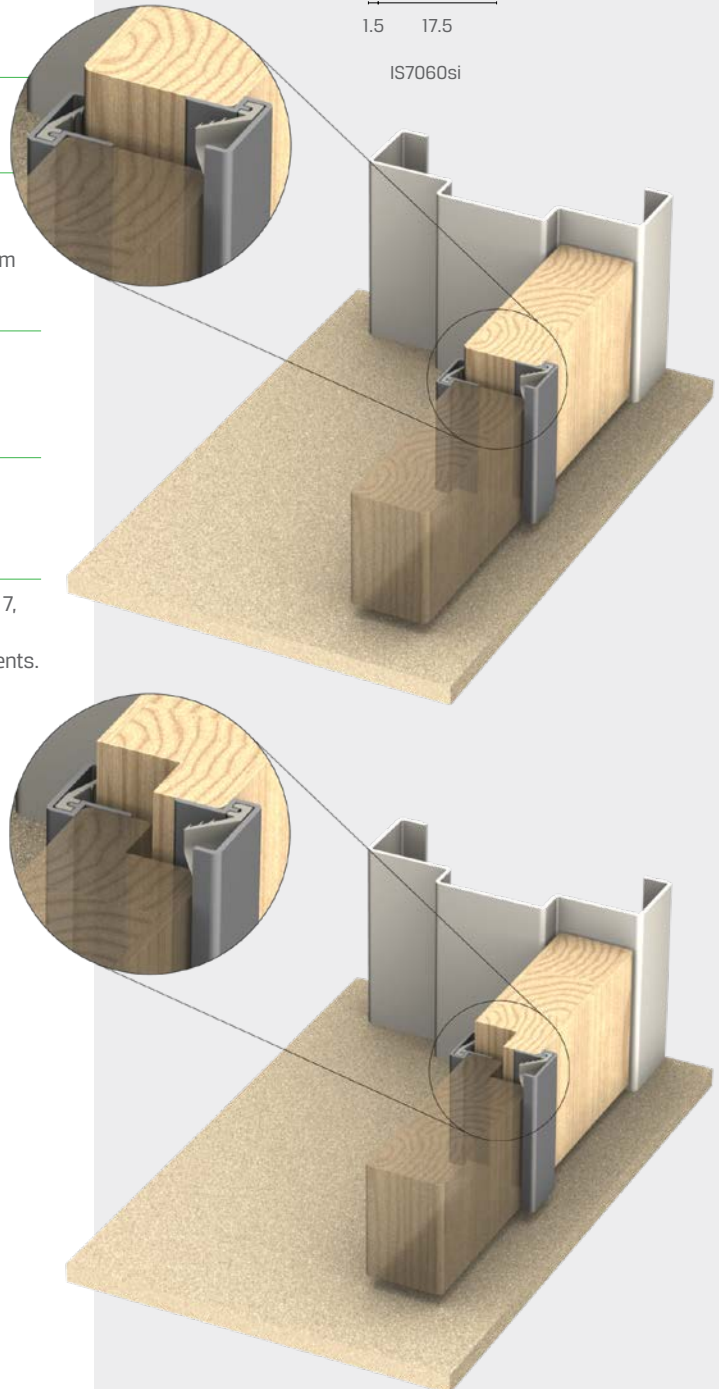

For more product information please scan QR code or visit www.kilargo.com.au/ourproducts/is7060si/



All seals proudly manufactured in Australia

IS7061



An astragal seal used with either plain or rebated meeting stiles on single swing, double doors (where only one door leaf is active). It provides an excellent acoustic, smoke, light, dust and weather seal.

This seal has proven smoke and acoustic performance, sealing on two faces of the door surface. The thin fixing leg allows this seal to be face fixed to the door (no rebating required where sufficient gap allows). This leg can also be checked to make way for locks and latches.

Gap size

- Min. 2.5mm / max. 6mm

Standard lengths

- 2250mm
- 3000mm
- Also available in: 250mm increments from 2000mm to 3500mm

Standard colours

- Silver anodised aluminium with black sealing blades

Fixing

- A door sequence selector should be considered unless one leaf is intended to be fixed

Approval/s

- Medium temperature smoke leakage approvals to AS1530 Part 7, compliant with AS6905 on proprietary door assemblies
- Conforms with BCA Specification C3.4 smoke sealing requirements
- Acoustically tested in accordance with AS1191, ISO140.3 and ISO10140-2
- Durability tests demonstrating over 100,000 open & close cycles

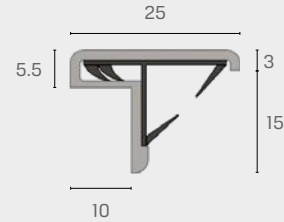

IS7061

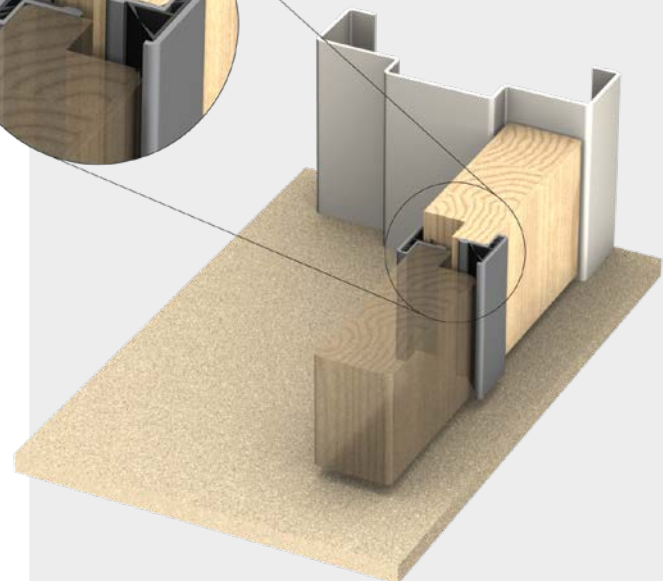
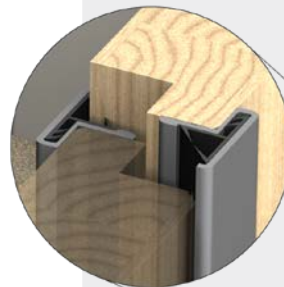
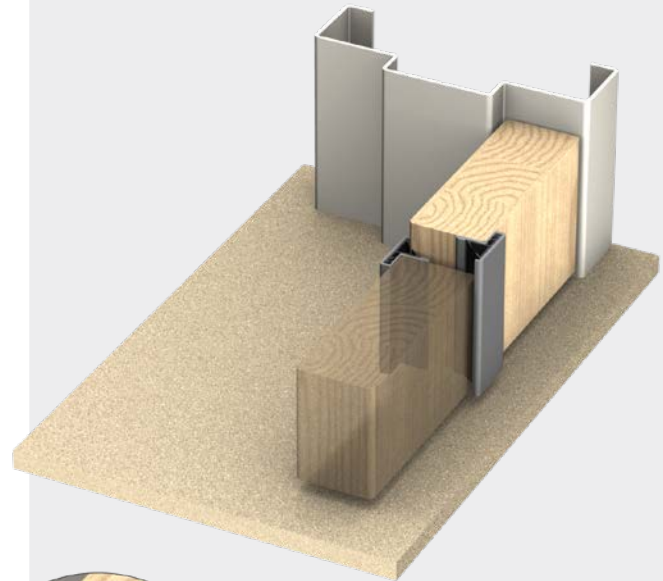

For more product information please scan QR code or visit www.kilargo.com.au/ourproducts/is7061/



All seals proudly manufactured in Australia

IS7062

A heavy duty astragal seal used with either plain or rebated meeting stiles on single swing, double doors (where only one door leaf is active). It provides privacy and security along the length of the meeting stile.

The mounting leg is drilled and countersunk to allow for left and right handed installation.

Standard lengths

- 2250mm
- 2500mm
- 3000mm

Standard colours

- Silver anodised aluminium finish

Fixing

- A door sequence selector should be considered unless one leaf is intended to be fixed

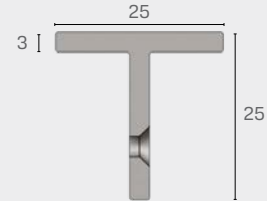

IS7062

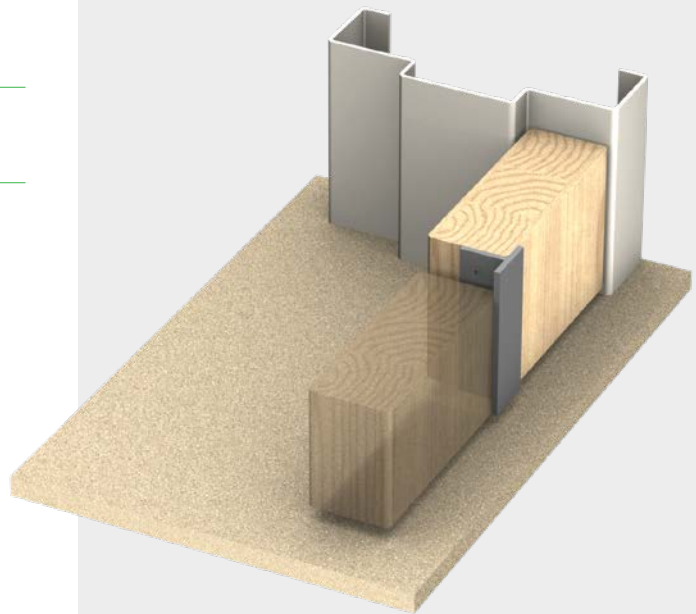

Meeting Stile/Perimeter Seals

IS7071si



A perimeter and meeting stile seal designed to be fitted to door perimeters and to plain or rebated meeting stiles of single swing and double swing, double doors. Two IS7071si seals can be installed onto one stile, allowing a space for a latch between the seals if required. These seals can be surface mounted or rebated.

It provides an excellent acoustic, smoke, light, dust and weather seal. IS7071si can be utilised as a perimeter seal around the head and jambs of single and double doors.

Gap size

- Surface-mounted: min. 5mm / max. 7mm
- Rebated application: min. 2mm / max. 4mm

Standard lengths

- 2250mm
- 3000mm
- Also available in: 250mm increments from 1000mm to 5000mm

Standard colours

- Silver anodised aluminium with grey silicone twin-fin gasket
- Black anodised aluminium with black silicone twin-fin gasket

Fixing

- Fixing screws are supplied
- Fixing holes are pre-drilled and countersunk
- A door sequence selector should be considered unless one leaf is intended to be fixed

Approval/s

- Fire tested to AS1530 Part 4 in accordance with AS1905 Part 1 (Perimeter Seal)
- Medium temperature smoke leakage approvals to AS1530 Part 7, compliant with AS6905 on proprietary door assemblies
- Conforms with BCA Specification C3.4 smoke sealing requirements
- Acoustically tested in accordance with AS1191, ISO140.3 and ISO10140-2
- Durability tests demonstrating over 1,000,000 open & close cycles

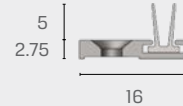

IS7071si

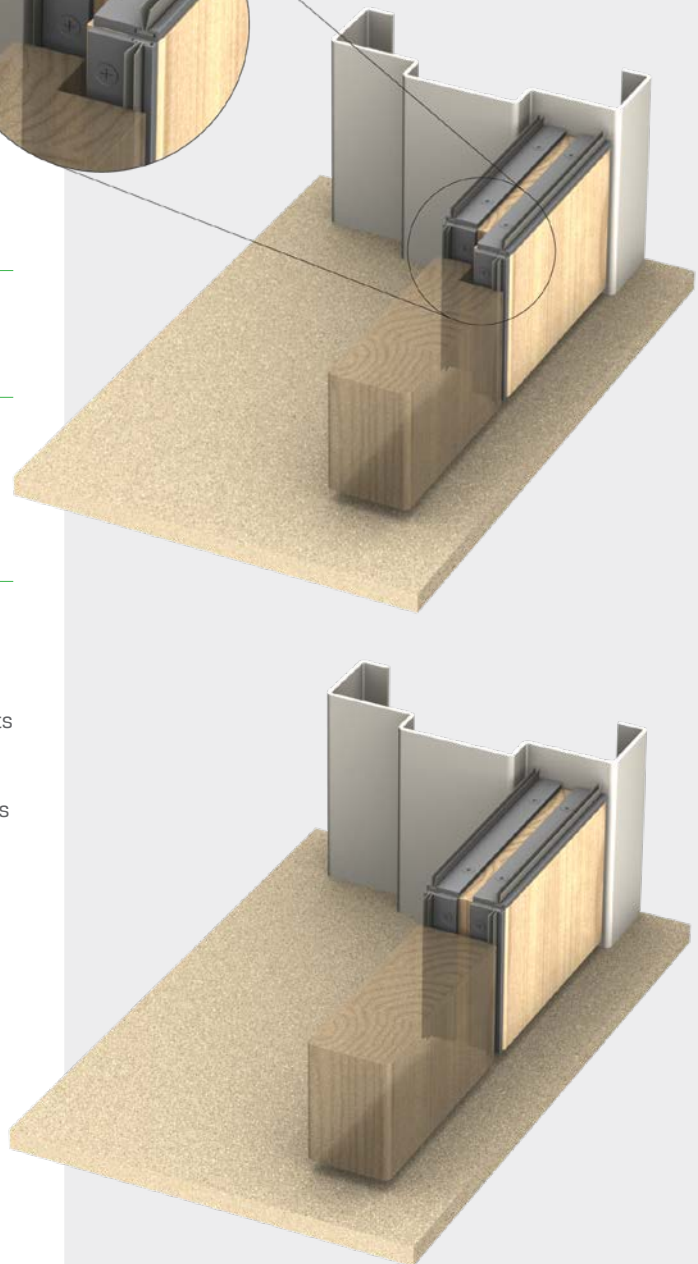
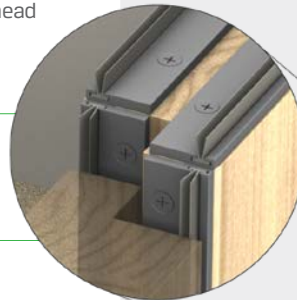

For more product information please scan QR code or visit www.kilargo.com.au/ourproducts/is7071si/



All seals proudly manufactured in Australia

IS7080, IS7080si



The IS7080 and IS7080si are aesthetically designed, compact perimeter seals, proven to be effective acoustic, cold smoke, light and weather seals. Both can be installed in lieu of a door stop on both steel and timber door frames (where frames are non fire-rated). The fixing holes are pre-drilled and slotted to allow the seal to be adjusted and positioned accurately. A decorative cover strip is supplied to conceal fixings.

The IS7080si version (silicone gasket) has been successfully tested on proprietary fire door assemblies (mounted on a 25mm frame stop). Also available in antimicrobial.

Gap size

- Min. 0mm / max. 10mm

Door set standard lengths

- Single: 1 x 1000mm, 2 x 2100mm
- Long Single: 1 x 1000mm, 2 x 2750mm
- Double: 3 x 2100mm
- Long Double: 1 x 2100mm, 2 x 2750mm

Standard lengths

- 1000mm
- 2250mm
- Also available in: 250mm increments from 1000mm to 5000mm

IS7080 standard colour

- Silver anodised aluminium with black gasket and grey cover strip

IS7080si standard colours

- Silver anodised aluminium with grey silicone gasket and grey cover strip
- Black anodised aluminium with black silicone gasket and black cover strip

Fixing

- When fixing IS7080 and IS7080si to rebated frames of single doors, specify a long back set door latch

Approval/s

- IS7080si fire tested to AS1530 Part 4 in accordance with AS1905 Part 1
- Certifications GVI.R26629, GVWZ.R26629, GVWZ7.R26629
- Medium temperature smoke leakage approvals to AS1530 Part 7, compliant with AS6905 on proprietary door assemblies (silicone version)
- Acoustically tested in accordance with AS1191, IS0140.3 and IS010140-2

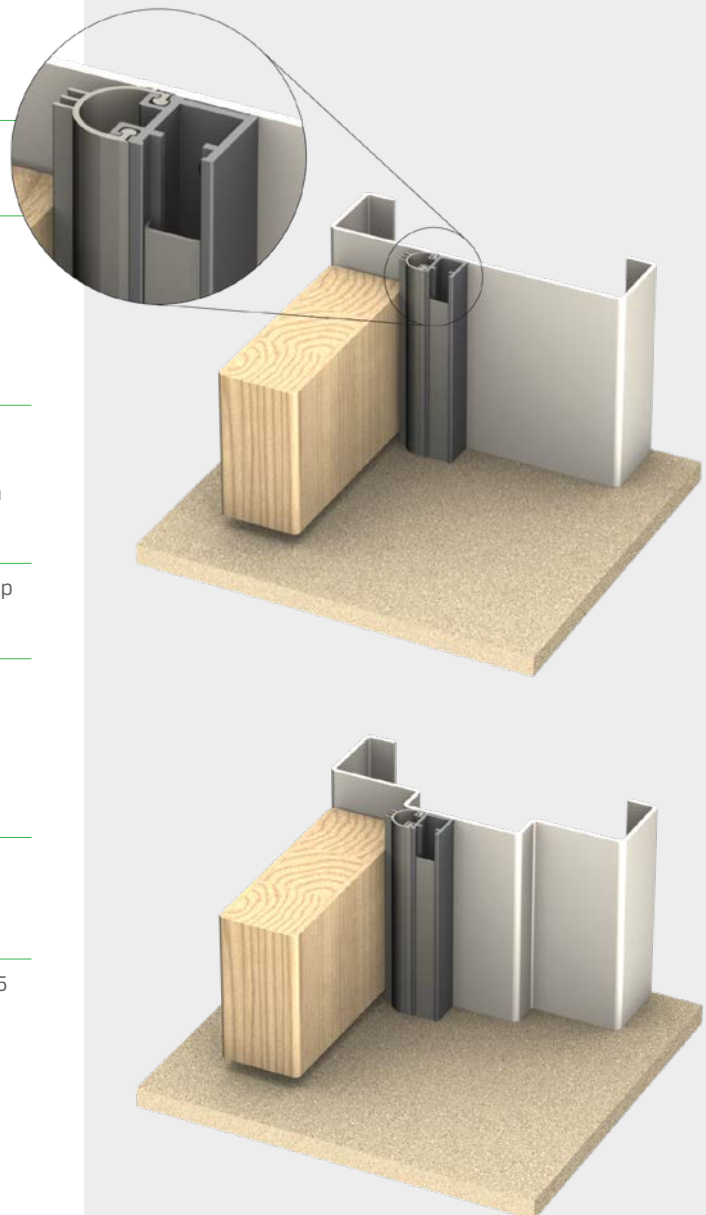
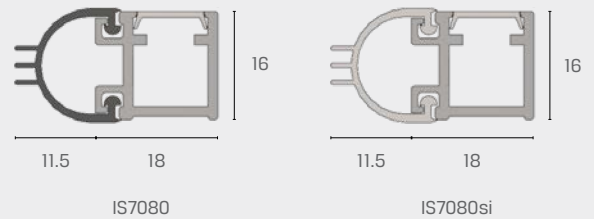

For more product information please scan QR code or visit www.kilargo.com.au/ourproducts/is7080/



All seals proudly manufactured in Australia

IS7085si



The IS7085si is an aesthetic compact perimeter seal, specifically designed for 'clean room' applications. The highly resilient, smooth silicone rubber gasket allows for easy cleaning and assists in preventing the movement of air borne contaminants, whilst also contributing to reduced sound transmission.

This seal can be used to replace the door stop on both steel and timber door frames, where frames are non fire-rated.

Gap size

- Min. 0mm / max. 7mm

Door set standard lengths

- Single: 1 x 1000mm, 2 x 2100mm
- Long Single: 1 x 1000mm, 2 x 2750mm
- Double: 3 x 2100mm
- Long Double: 1 x 2100mm, 2 x 2750mm

Standard lengths

- 1000mm
- 2250mm
- Also available in: 250mm increments from 1000mm to 5000mm

Standard colours

- Silver anodised aluminium with grey silicone gasket and grey cover strip
- Black anodised aluminium with black silicone gasket and black cover strip

Fixing

- When fixing the IS7085si seal to rebated frames of single doors, specify a long back set door latch

Approval/s

- Fire tested to AS1530 Part 4 in accordance with AS1905 Part 1
- Certifications GVV1.R26629, GVWZ.R26629, GVWZ7.R26629
- Acoustically tested in accordance with AS1191, ISO140.3 and ISO10140-2

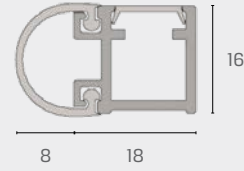

IS7085si

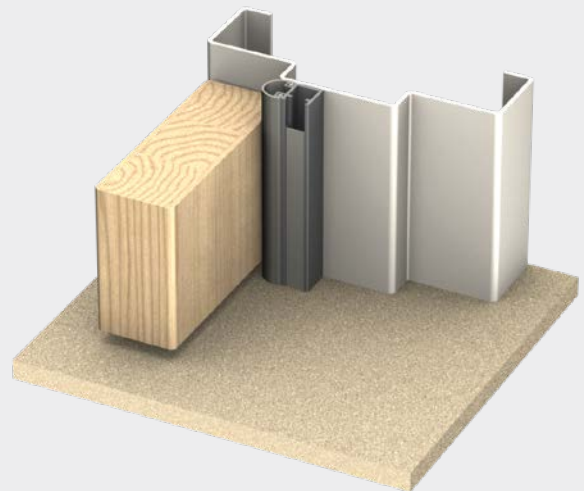
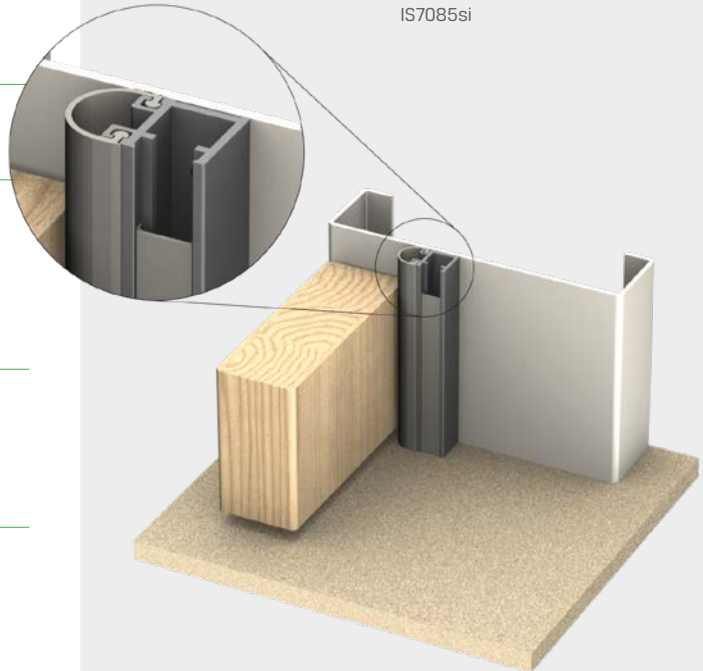

For more product information please scan QR code or visit www.kilargo.com.au/ourproducts/is7085si/



All seals proudly manufactured in Australia

IS7087si



The IS7087si adjustable perimeter seal is designed for high performance acoustic applications and is fitted to the head and jambs of door frame perimeters, with or without door stops. This seal can achieve up to 10mm sealing adjustment once the seal has been fitted for maximum sound control.

Fixing screws are concealed behind an aesthetic, tamper-proof aluminium cover plate.

The IS7087si has been successfully tested on proprietary fire door assemblies (mounted on a 25mm frame stop).

Gap size

- Min. 0mm / max. 10mm

Door set standard lengths

- Single: 1 x 1000mm, 2 x 2100mm
- Long Single: 1 x 1000mm, 2 x 2750mm
- Double: 3 x 2100mm
- Long Double: 1 x 2100mm, 2 x 2750mm

Standard lengths

- 1000mm
- 2250mm
- Also available in: 250mm increments from 1000mm to 5000mm

Standard colours

- Silver anodised aluminium with grey silicone gasket and grey PVC rigid cover strip (Black silicone gasket and cover strip also available upon request)

Fixing

- When fixing the IS7087si seal to rebated frames of single doors, specify a long back set door latch

Approval/s

- Fire tested to AS1530 Part 4 in accordance with AS1905 Part 1
- Certifications GVI.R26629, GVWZ.R26629, GVWZ7.R26629
- Acoustically tested in accordance with AS1191, ISO140.3 & ISO10140-2
- Durability tests demonstrating over 100,000 open and close cycles

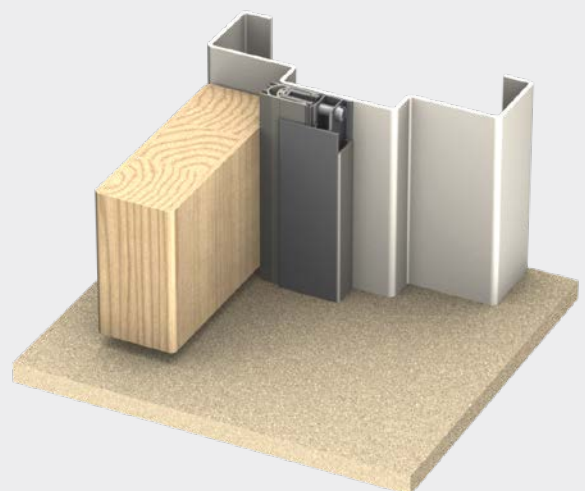
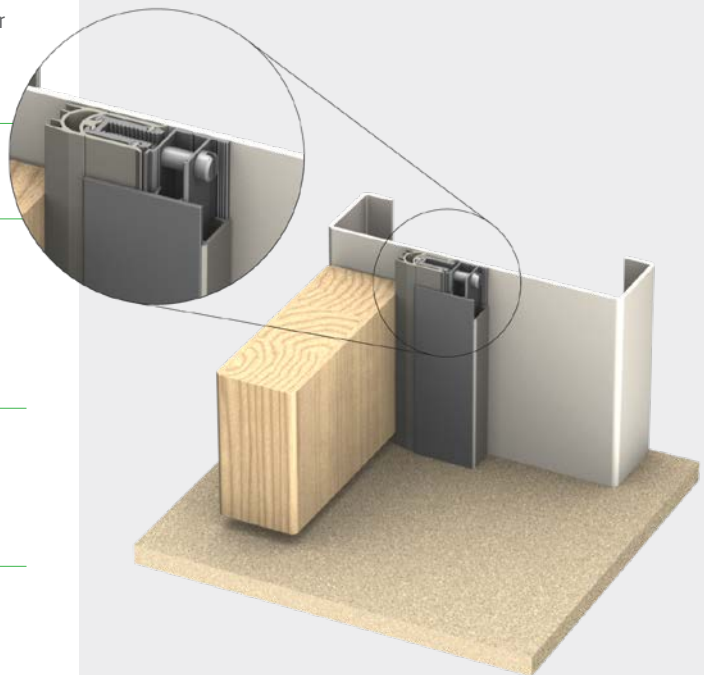
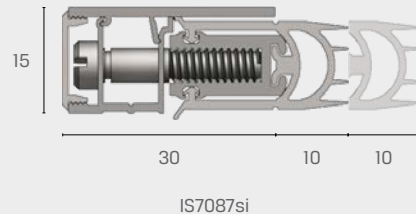

For more product information please scan QR code or visit www.kilargo.com.au/ourproducts/is7087si/



All seals proudly manufactured in Australia

IS7090si



IS7090si self-adjusting and adjustable (spring-loaded) perimeter seal is designed for high performance acoustic applications. This seal can be fitted to the head and jambs of door frame perimeters in lieu of door stops, where frames are non fire-rated.

It's unique spring loaded mechanism, automatically self-adjusts to cater for movement or uneven doors. It is also mechanically adjustable to ensure the desired seal is maintained.

Durable polypropylene fins are incorporated within the gasket housing to provide additional smoke and acoustic sealing properties. An aesthetic, anodised aluminium tamper-proof cover plate simply clips onto the main carrier to conceal fixings.

The IS7090si has been successfully tested on proprietary fire door assemblies (mounted on a 25mm frame stop).

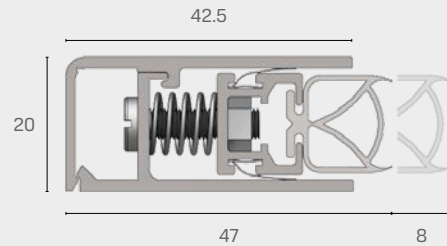

IS7090si

Gap size

- Min. 0mm / max. 8mm

Door set standard lengths

- Single: 1 x 1000mm, 2 x 2100mm
- Long Single: 1 x 1000mm, 2 x 2750mm
- Double: 3 x 2100mm
- Long Double: 1 x 2100mm, 2 x 2750mm

Standard lengths

- 1000mm
- 2250mm
- Also available in: 250mm increments from 1000mm to 5000mm

Standard colours

- Silver anodised aluminium with grey silicone gasket (Black silicone gasket also available upon request)

Fixing

- When fixing the IS7090si seal to rebated frames of single doors, specify a long back set door latch

* Kilargo does not recommend the installation of profiles with 'snap-on' aluminium cover plates for aluminium door frame systems.

Approval/s

- Fire tested to AS1530 Part 4 in accordance with AS1905 Part 1
- Certifications GVIY.R26629, GVWZ.R26629, GVWZ7.R26629
- Acoustically tested in accordance with AS1191, ISO140.3 and ISO10140-2
- Durability tests demonstrating over 100,000 open and close cycles

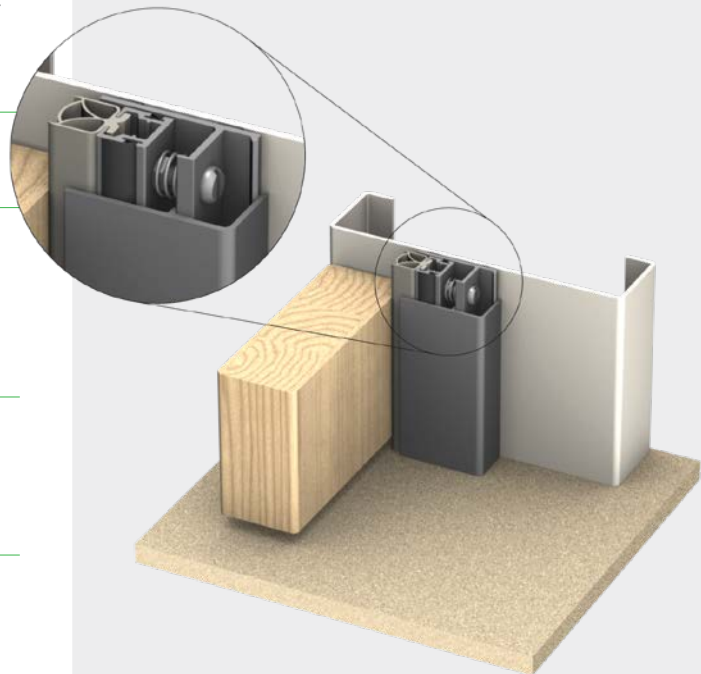

For more product information please scan QR code or visit www.kilargo.com.au/ourproducts/is7090si/



All seals proudly manufactured in Australia

IS7095si



The IS7095si heavy duty, adjustable perimeter seal is designed for high performance acoustic applications. This seal can be fitted to the head and jambs of door frame perimeters in lieu of door stops, where frames are non fire-rated.

This seal can achieve up to 12mm sealing adjustment once the seal has been fitted, for maximum sound control. Fixing screws are concealed behind the aesthetic tamper-proof aluminium cover plate.

The IS7095si has been successfully tested on proprietary fire door assemblies (mounted on a 25mm frame stop).

Gap size

- Min. 0mm / max. 12mm

Door set standard lengths

- Single: 1 x 1000mm, 2 x 2100mm
- Long Single: 1 x 1000mm, 2 x 2750mm
- Double: 3 x 2100mm
- Long Double: 1 x 2100mm, 2 x 2750mm

Standard lengths

- 1000mm
- 2250mm
- Also available in: 250mm increments from 1000mm to 5000mm

Standard colours

- Silver anodised aluminium with grey silicone gasket and grey PVC rigid cover strip (Black silicone gasket and cover strip also available upon request)

Fixing

- When fixing the IS7095si seal to rebated frames of single doors, specify a long back set door latch

Approval/s

- Fire tested to AS1530 Part 4 in accordance with AS1905 Part 1
- Certifications GVI1.R26629, GVWZ.R26629, GVWZ7.R26629
- Acoustically tested in accordance with AS1191, ISO140.3 & ISO10140-2
- Durability tests demonstrating over 100,000 open & close cycles

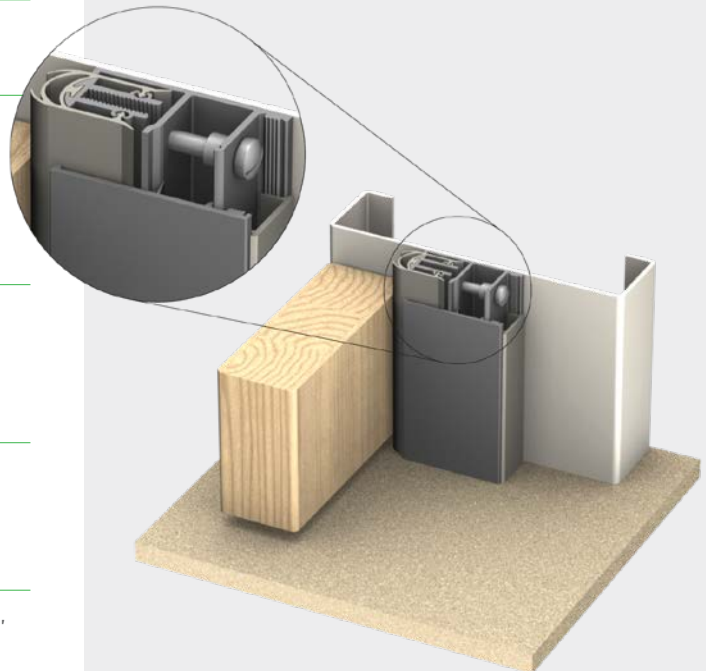
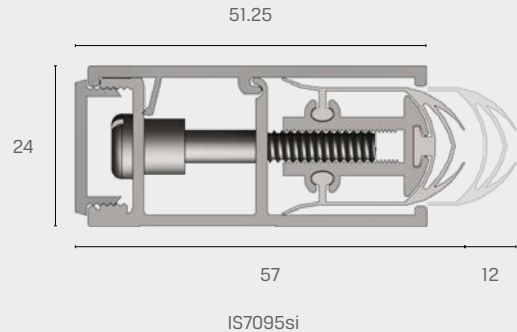

7000 Series



For more product information please scan QR code or visit www.kilargo.com.au/ourproducts/is7095si/



All seals proudly manufactured in Australia

IS7110si



The IS7110si is a compression type perimeter seal, designed to be fitted to an existing door stop, around the head and jambs of single swing doors.

Gap size

- Min. 0mm / max. 7mm

Door set standard lengths

- Single: 1 x 1000mm, 2 x 2100mm
- Long Single: 1 x 1000mm, 2 x 2750mm
- Double: 3 x 2100mm
- Long Double: 1 x 2100mm, 2 x 2750mm

Standard lengths

- 1000mm
- 2250mm
- Also available in: 250mm increments from 1000mm to 5000mm

Standard colours

- Silver anodised aluminium with grey silicone gasket and grey cover strip
- Black anodised aluminium with black silicone gasket and black cover strip

Approval/s

- Fire tested to AS1530 Part 4 in accordance with AS1905 Part 1
- Certifications GVI1.R26629, GVWZ.R26629, GVWZ7.R26629
- Acoustically tested in accordance with AS1191, ISO140.3 and ISO10140-2

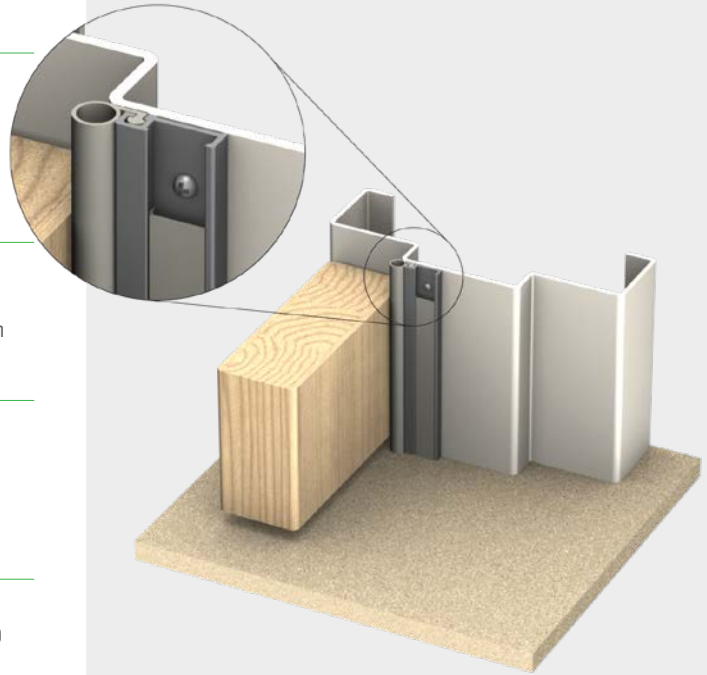

For more product information please scan QR code or visit www.kilargo.com.au/ourproducts/is7110si/



All seals proudly manufactured in Australia

IS7130si



The IS7130si is an effective acoustic seal suitable for fitting to door stops of sufficient depth, around the head and jambs of single swing doors. It has two silicone compression gaskets providing excellent acoustic and air leakage containment. It can also be rebated into meeting stiles and door bottoms as a sweep-action type seal.

Gap size

- Min. 6mm / max. 8mm (when recessed)
- Allow 12mm to 13mm when surface-mounted

Standard lengths

- 1000mm
- 2250mm
- Also available in: 250mm increments from 1000mm to 5000mm

Standard colours

- Silver anodised aluminium with grey silicone gaskets (Black silicone gaskets also available upon request)

Approval/s

- Acoustically tested in accordance with AS1191, ISO140.3 and ISO10140-2

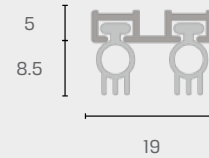

IS7130si

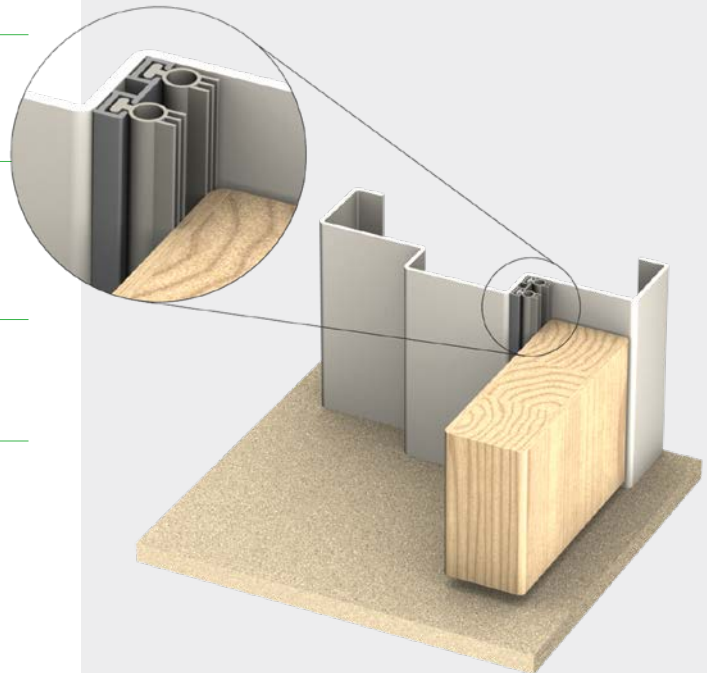

For more product information please scan QR code or visit www.kilargo.com.au/ourproducts/is7130si/



All seals proudly manufactured in Australia

IS7190si



The IS7190si perimeter seal is designed for high performance acoustic applications. This seal can be fitted to the head and jambs of door frame perimeters in lieu of door stops, where frames are non fire-rated. An anodised aluminium tamper-proof cover 'plate' simply clips and locks onto the main carrier to conceal fixings.

The IS7190si has been successfully tested on proprietary fire door assemblies (mounted on a 25mm frame stop).

Gap size

- Min. 0mm / max. 12mm

Door set standard lengths

- Single: 1 x 1000mm, 2 x 2100mm
- Long Single: 1 x 1000mm, 2 x 2750mm
- Double: 3 x 2100mm
- Long Double: 1 x 2100mm, 2 x 2750mm

Standard lengths

- 1000mm
- 2250mm
- Also available in: 250mm increments from 1000mm to 5000mm

Standard colours

- Silver anodised aluminium with grey silicone gasket (Black silicone gasket also available upon request)

Fixing

- When fixing the IS7190si seal to rebated frames of single doors, specify a long back set door latch

* Kilargo does not recommend the installation of profiles with 'snap-on' aluminium cover plates for aluminium door frame systems.

Approval/s

- Fire tested to AS1530 Part 4 in accordance with AS1905 Part 1
- Certifications GYI.R26629, GVWZ.R26629, GVWZ7.R26629
- Acoustically tested in accordance with AS1191, ISO140.3 and ISO10140-2
- Durability tests demonstrating over 100,000 open & close cycles

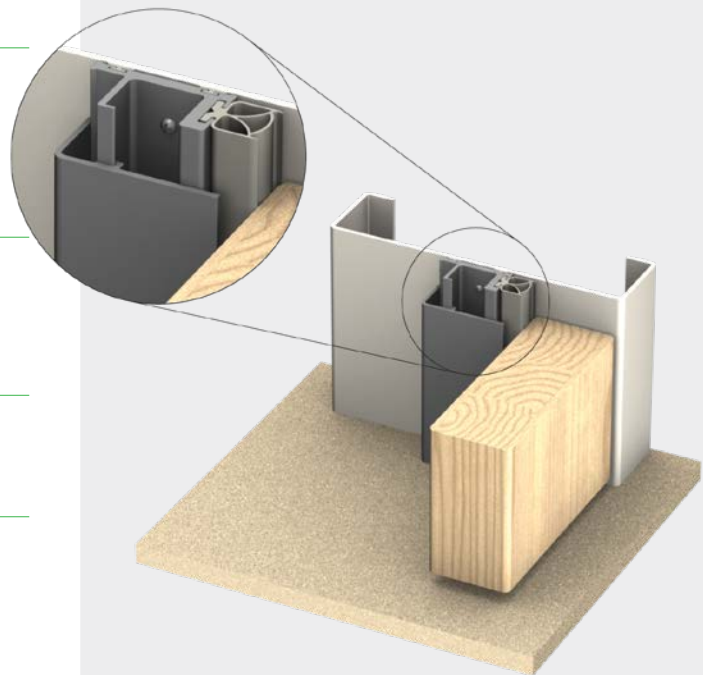
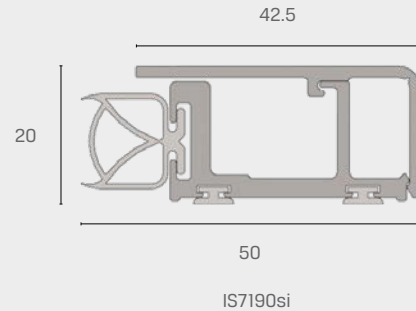

For more product information please scan QR code or visit www.kilargo.com.au/ourproducts/is7190si/



All seals proudly manufactured in Australia

IS7195si



The IS7195si perimeter seal is also designed for high performance acoustic applications and is fitted to the head and jambs of door perimeters (with or without door stops) on steel or timber frames. It's an ideal seal for heavy traffic areas such as hospitals, schools, prisons and TAFES, etc.

An anodised aluminium cover 'strip' simply 'presses' onto the main carrier to conceal fixings. Once fitted, the space behind this cover plate can be utilised for low voltage cable management.

The IS7195si has been successfully tested on proprietary fire door assemblies (mounted on a 25mm frame stop).

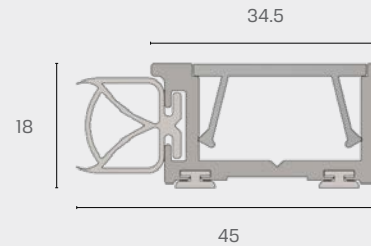

IS7195si

Gap size

- Min. 0mm / max. 15mm

Door set standard lengths

- Single: 1 x 1000mm, 2 x 2100mm
- Long Single: 1 x 1000mm, 2 x 2750mm
- Double: 3 x 2100mm
- Long Double: 1 x 2100mm, 2 x 2750mm

Standard lengths

- 1000mm
- 2250mm
- Also available in: 250mm increments from 1000mm to 5000mm

Standard colours

- Silver anodised aluminium with grey silicone gasket (Black silicone gasket also available upon request)

Fixing

- When fixing the IS7195si seal to rebated frames of single doors, specify a long back set door latch

Approval/s

- Fire tested to AS1530 Part 4 in accordance with AS1905 Part 1
- Certifications GVI1.R26629, GVWZ.R26629, GVWZ7.R26629
- Medium temperature smoke leakage approvals to AS1530 Part 7, compliant with AS6905 on proprietary door assemblies
- Acoustically tested in accordance with AS1191, ISO140.3 and ISO10140-2
- Durability tests demonstrating over 100,000 open & close cycles

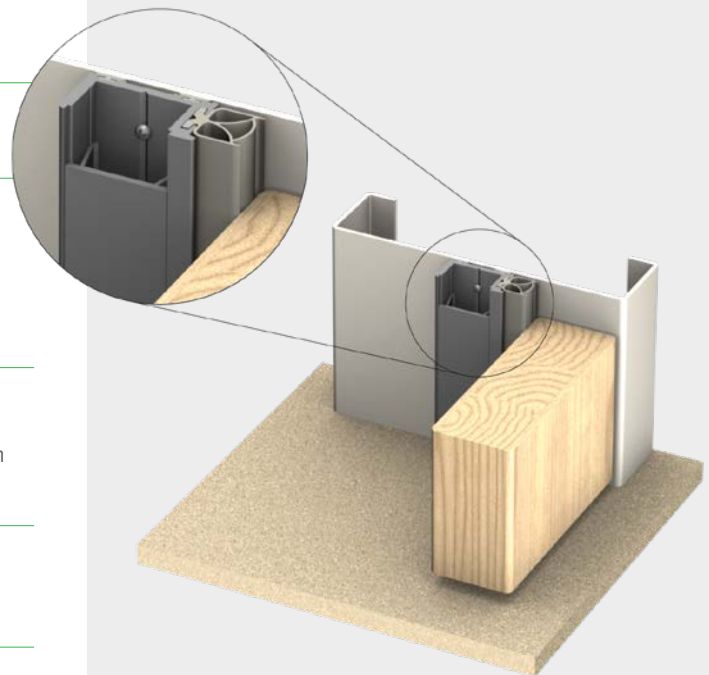

For more product information please scan QR code or visit www.kilargo.com.au/ourproducts/is7195si/



All seals proudly manufactured in Australia

IS7310si, IS7320si, (IS7300si), IS7330si



The IS7310si and IS7320si seals are adjustable, aluminium meeting stile and door edge seals for frameless glass sliding doors.

The IS7330si seal is also adjustable to suit hinged or pivoted frameless glass doors.

All seals are designed to suit 12-15mm frameless glass doors, providing ambient and medium temperature smoke containment, along with draught and dust protection. The high performance silicone gaskets also protect glass doors from colliding during closure. These seals have an easy self-adhesive application and can be used independently for various door applications.

Gap size

- Dependent upon application

Standard lengths

- 2250mm
- Also available in: 250mm increments from 1000mm to 5000mm

Standard colours

- Silver anodised aluminium with grey silicone gasket (Black silicone gasket also available upon request)

Approval/s

- Conforms with BCA Specification C3.4 smoke sealing requirements

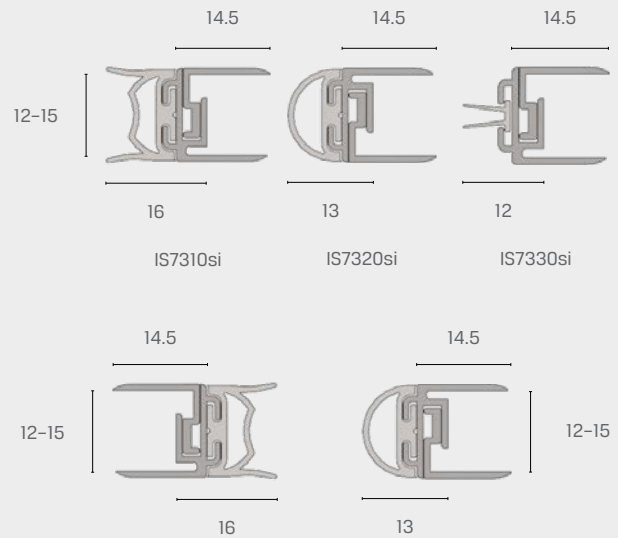

IS7300si—a combination set of IS7310si and IS7320si.

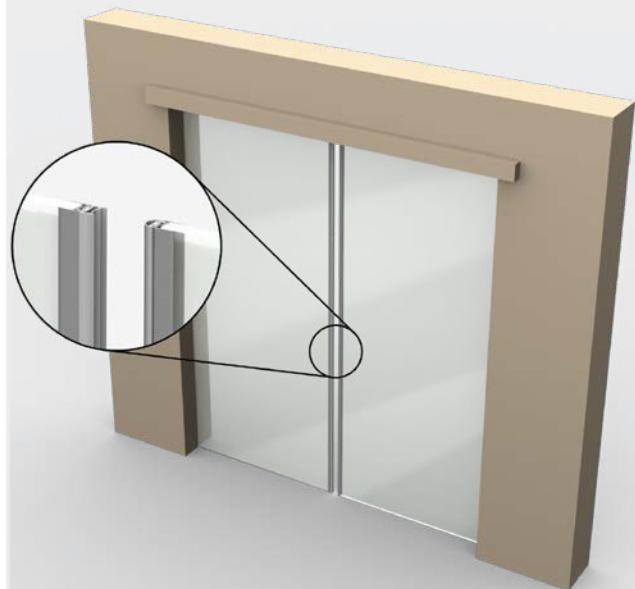

For more product information please scan QR code or visit www.kilargo.com.au/ourproducts/is7310si/



All seals proudly manufactured in Australia

IS7340si, IS7345si, IS7350si, IS7355si



These translucent polycarbonate astragal seals suit 10mm and 12mm thick frameless glass doors, incorporating high temperature semi-transparent silicone gaskets. With an easy self-adhesive application, the seals are available with a silicone flexible bubble compression seal, or a silicone flexible twin-fin wiping seal, to suit various glass door applications.

All seals are designed to suit 10mm and 12mm frameless glass doors, providing ambient and medium temperature smoke containment, along with draught and dust protection. The high performance silicone gaskets also protect glass doors from colliding during closure.

IS7340si and IS7345si suit 10mm glass
 IS7350si and IS7355si suit 12mm glass

Gap size

- Min. 7mm / max. 9mm (prior to installation)

Standard lengths

- 2250mm
- Also available in: 250mm increments from 1000mm to 5000mm

Standard colours

- Translucent UV stabilised polycarbonate with semi-transparent silicone bubble or twin-finned gasket

Approval/s

- Conforms with BCA Specification C3.4 smoke sealing requirements

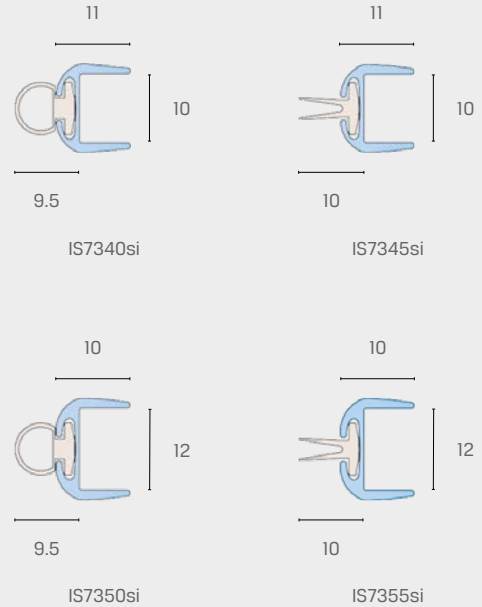

For more product information please scan QR code or visit www.kilargo.com.au/ourproducts/is7340si/



All seals proudly manufactured in Australia



8000 SERIES

Automatic Door Bottom Seals

-  Automatic door bottom seals incorporate a spring-loaded mechanism that automatically lowers to seal the gap as the door closes and retracts as it is opened. They are available in either face-fixed, semi-rebated or fully mortised options.

IS8005si



A slim-line, concealed automatic door bottom seal which is mortised into the bottom edge of single action doors. It operates automatically by a spring loaded mechanism which lifts the seal clear of the floor as soon as the door is opened.

Mounted into a 24mm deep x 13mm wide mortised groove, the seal is fixed via flanges on the underside of the door, operating automatically by pressure against the door jamb on its adjustable strike button. The seal contains a high efficiency mechanism to assist with the closing force requirements detailed in AS1428/1 (Design for Access and Mobility).

Aesthetic brass adjustment button and injection moulded, reinforced nylon screw-fixed radiused end plates ensure longevity of the seal mechanism, avoiding dust build-up and preventing foreign matter entering the mechanism housing.

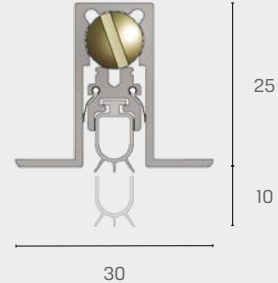

30

IS8005si

Gap size

- Min. 3mm / max. 10mm

Standard lengths

- 380mm
- 600mm
- 820mm
- 920mm
- 1070mm
- 1220mm

IS8005si maximum allowable cut-back sizes:

- 380mm seal cuts to 275mm
- 600mm seal cuts to 380mm
- 820mm seal cuts to 600mm
- 920mm seal cuts to 820mm
- 1070mm seal cuts to 920mm
- 1220mm seal cuts to 1070mm

(*Seals can be cut on site for exact dimension).

Standard colours

- Silver anodised aluminium with grey reinforced nylon end plates, grey silicone gasket. (Black silicone gasket also available upon request.)

Approval/s

- Fire tested to AS1530 Part 4 in accordance with AS1905 Part 1
- Medium temperature smoke leakage approvals to AS1530 Part 7, compliant with AS6905 on proprietary door assemblies
- Conforms with BCA Specification C3.4 smoke sealing requirements
- Acoustically tested in accordance with AS1191, ISO140.3 and ISO10140-2
- Durability tests demonstrating over 1,000,000 open & close cycles

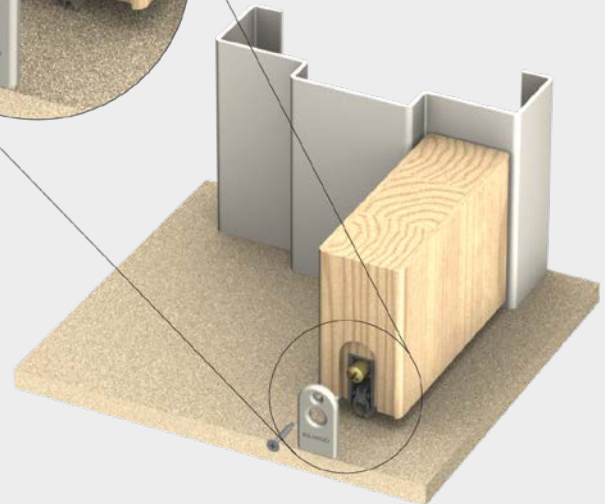

For more product information please scan QR code or visit www.kilargo.com.au/ourproducts/is8005si/



All seals proudly manufactured in Australia

IS8010si



A medium duty, concealed automatic door bottom seal which is mortised into the bottom edge of single action doors. It operates automatically by a spring loaded mechanism which lifts the seal clear of the floor as soon as the door is opened.

Mounted into a 35mm deep x 15mm wide machined groove, the seal is screwfixed back into the door stiles via stainless steel end plates, holding the seal in place. The seal operates automatically by pressure against the door jamb on its adjustable strike button. The seal contains a high efficiency mechanism to assist with the closing force requirements detailed in AS1428/1 (Design for Access and Mobility).

Gap size

- Min. 3mm / max. 15mm

Standard lengths

- 380mm
- 600mm
- 820mm
- 920mm
- 1070mm
- 1220mm

(*Longer lengths available to special order).

IS8010si maximum allowable cut-back sizes:

- 380mm seal cuts to 275mm
- 600mm seal cuts to 380mm
- 820mm seal cuts to 600mm
- 920mm seal cuts to 820mm
- 1070mm seal cuts to 920mm
- 1220mm seal cuts to 1070mm

(*Seals can be cut on site for exact dimension).

Standard colours

- Silver anodised aluminium with stainless steel end plates, grey silicone gasket. (Black silicone gasket also available upon request.)

Approval/s

- Fire tested to AS1530 Part 4 in accordance with AS1905 Part 1
- Certifications GVYI.R26629, GVWZ.R26629, GVWZ7.R26629
- Medium temperature smoke leakage approvals to AS1530 Part 7, compliant with AS6905 on proprietary door assemblies
- Conforms with BCA Specification C3.4 smoke sealing requirements
- Acoustically tested in accordance with AS1191, ISO140.3 and ISO10140-2
- Durability tests demonstrating over 1,000,000 open and close cycles

*Note: Radiused stainless steel end plates also available upon request.

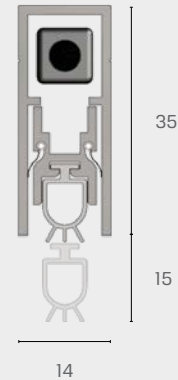

IS8010si

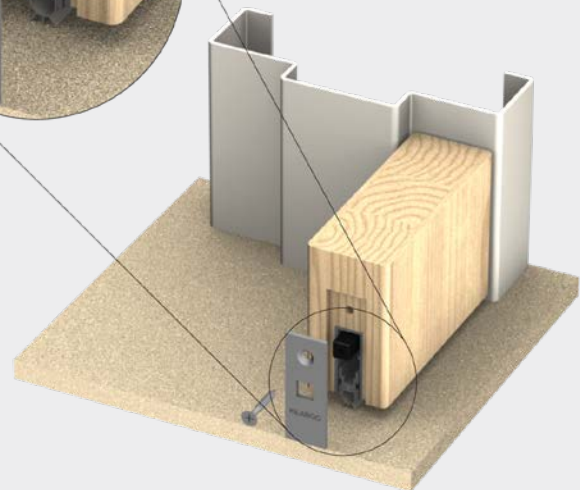

For more product information please scan QR code or visit www.kilargo.com.au/ourproducts/is8010si/



All seals proudly manufactured in Australia

IS8011si



A medium duty, automatic door bottom seal which can be face-fixed or semi-rebated to the bottom edge of single action doors. It operates automatically by a spring loaded mechanism which lifts the seal clear of the floor as soon as the door is opened.

The seal is fixed to the face of the door bottom using the ferrules and mounting screws provided. When the seal is to be semi-rebated, the seal is mounted into a 35mm deep x 14mm wide machined groove in the side of the door where the seal is to be positioned. The seal operates automatically by pressure against the door jamb on its adjustable strike button. The seal contains a high efficiency mechanism to assist with the closing force requirements detailed in AS1428/1 (Design for Access and Mobility).

Aesthetic, reinforced nylon push-fit end plates ensure longevity of the seal mechanism.

Gap size

- Min. 3mm / max. 15mm

Standard lengths

- 380mm
- 600mm
- 820mm
- 920mm
- 1070mm
- 1220mm

(*Longer lengths available to special order)

IS8011si maximum allowable cut-back sizes:

- 380mm seal cuts to 275mm
- 600mm seal cuts to 380mm
- 820mm seal cuts to 600mm
- 920mm seal cuts to 820mm
- 1070mm seal cuts to 920mm
- 1220mm seal cuts to 1070mm

(*Seals can be cut on site for exact dimension)

Standard colours

- Silver anodised aluminium with grey end plates and grey silicone gasket. (Black end plates and black silicone gasket also available upon request.)

Approval/s

- Fire tested to AS1530 Part 4 in accordance with AS1905 Part 1
- Certifications GYI.R26629, GVWZ.R26629, GVWZ7.R26629
- Medium temperature smoke leakage approvals to AS1530 Part 7, compliant with AS6905 on proprietary door assemblies
- Conforms with BCA Specification C3.4 smoke sealing requirements
- Acoustically tested in accordance with AS1191, ISO140.3 and ISO10140-2
- Durability tests demonstrating over 1,000,000 open & close cycles

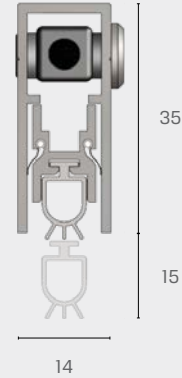

IS8011si

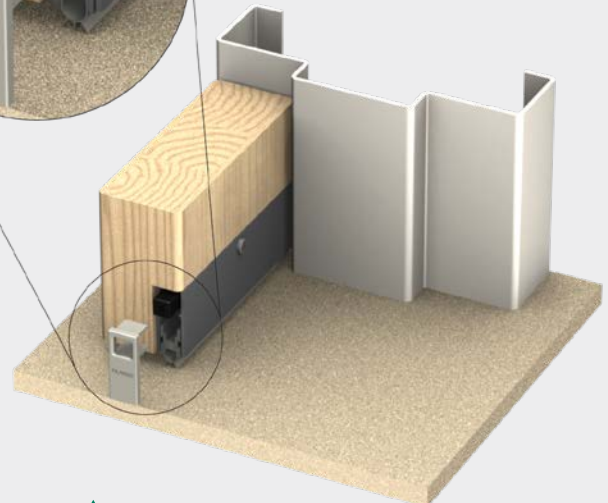
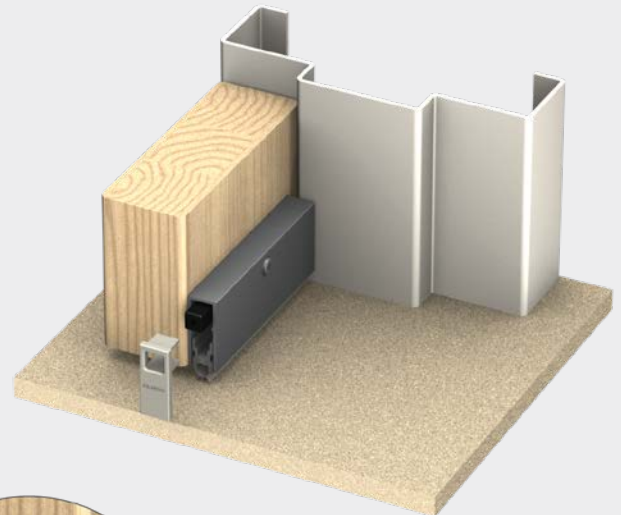

For more product information please scan QR code or visit www.kilargo.com.au/ourproducts/is8011si/



All seals proudly manufactured in Australia

Automatic Door Bottom Seals

IS8020si



A heavy duty, automatic door bottom seal which can be face-fixed or fully mortised into the bottom edge of single action doors. The seal has a spring loaded mechanism which lifts the seal clear of the floor as soon as the door is opened. Pressure against the door jamb on the adjustable brass strike button operates the seal automatically.

Face-fixed: The seal is fixed to the face of the door bottom using the long fixing screws provided. (see detailed fitting instructions). The reversible aluminium top cover plate conceals the fixing screws and provides an aesthetic, architectural finish. A set of screw-fixed reinforced nylon end plates ensure longevity of the seal mechanism.

Fully-mortised: When the seal is to be fully-mortised, the seal (minus the top cover plate) is mounted into a 54mm deep x 22mm wide machined groove and screw-fixed back into the door stiles via stainless steel end plates, holding the seal in place.

Semi-rebated: When the seal is to be semi-rebated, the seal is mounted into a stepped rebate: a 54mm deep x 22mm wide machined groove on the side of the door to which the seal will be positioned. The seal can be screw-fixed into position and fitted with the cast-aluminium end plates provided.

The seal contains a high efficiency mechanism to assist with the closing force requirements detailed in AS1428/1 (Design for Access and Mobility).

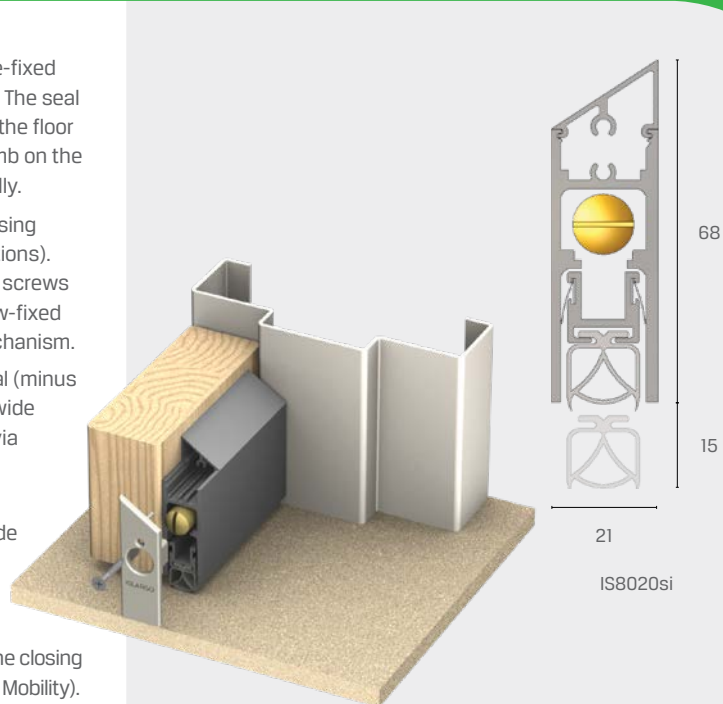

Gap size

- Min. 3mm / max. 15mm

Standard lengths

- 450mm
- 610mm
- 820mm
- 920mm
- 1070mm
- 1220mm
- 1500mm

(*Longer length available to special order up to a maximum 1600mm)

IS8020si maximum allowable cut-back sizes:

- 450mm seal cuts to 275mm
- 610mm seal cuts to 450mm
- 820mm seal cuts to 610mm
- 920mm seal cuts to 610mm
- 1070mm seal cuts to 920mm
- 1220mm seal cuts to 1070mm
- 1500mm seal cuts to 1220mm

(*Seals can be cut on site for exact dimension)

Standard colours

- Silver anodised aluminium with grey end plates (or stainless steel end plates) and grey silicone gasket
- Black anodised aluminium with black end plates (or stainless steel end plates) and black silicone gasket

Approval/s

- Fire tested to AS1530 Part 4 in accordance with AS1905 Part 1
- Certifications GVV1.R26629, GVWZ.R26629, GVWZ7.R26629
- Medium temperature smoke leakage approvals to AS1530 Part 7, compliant with AS6905 on proprietary door assemblies
- Conforms with BCA Specification C3.4 smoke sealing requirements
- Acoustically tested in accordance with AS1191, IS0140.3 and IS010140-2
- Durability tests demonstrating over 1,000,000 open & close cycles



For more product information please scan QR code or visit www.kilargo.com.au/ourproducts/is8020si/

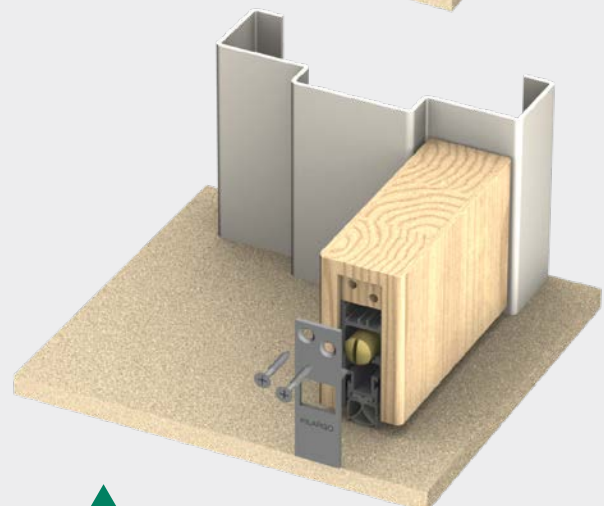
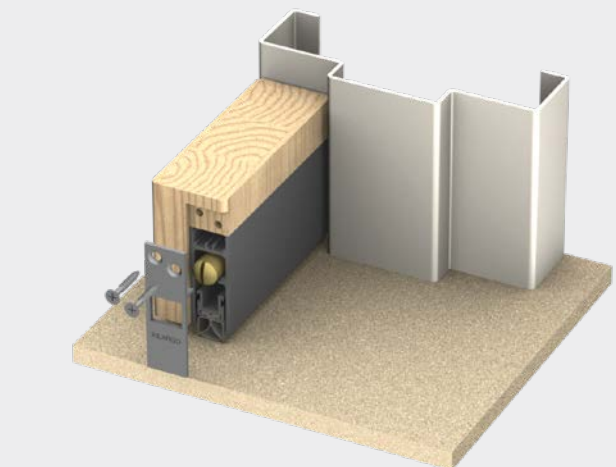

All seals proudly manufactured in Australia

IS8035si, IS8036si



Medium duty, automatic door bottom seals which can be semi-rebated (IS8035si) or face-fixed (IS8035si or IS8036si) to the bottom edge of single action doors. The seals have a spring loaded mechanism which lifts the seal clear of the floor as soon as the door is opened. Pressure against the door jamb on the adjustable strike button operates the seal automatically.

IS8035si: This seal can be face-fixed or semi-rebated to the door bottom using the fixings provided. When the seal is to be semi-rebated, the seal is mounted into a 37mm deep x 13mm wide machined groove. The screw line is covered by an aesthetic flexible PVC cover strip.

IS8036si: This seal is face-fixed to the bottom edge of single action doors. It has an architectural 'curved' cover plate to conceal fixing points and provide an aesthetic finish.

Both seals have brass adjustment buttons and injection moulded, push-fit reinforced nylon end plates plus a high efficiency mechanism to assist with the closing force requirements detailed in AS1428/1 (Design for Access and Mobility).

Gap size

- Min. 3mm / max. 10mm

Standard lengths

- 380mm
- 600mm
- 820mm
- 920mm
- 1070mm
- 1220mm

IS8035si and IS8036si

maximum allowable cut-back sizes:

- 380mm seal cuts to 275mm
- 600mm seal cuts to 380mm
- 820mm seal cuts to 600mm
- 920mm seal cuts to 820mm
- 1070mm seal cuts to 920mm
- 1220mm seal cuts to 1070mm

(*Seal can be cut on site for exact dimensions)

IS8035si Standard colours

- Silver anodised aluminium with grey end plates, grey cover strip and grey silicone gasket.
- Black anodised aluminium with black end plates, black cover strip and black silicone gasket.

IS8036si Standard colour

- Silver anodised aluminium cover plate with grey end plates and grey silicone gasket. (Black end plates and black gasket also available upon request.)

Approval/s

- Fire tested to AS1530 Part 4 in accordance with AS1905 Part 1
- Certifications GYI.R26629, GVWZ.R26629, GVWZ7.R26629
- Medium temperature smoke leakage approvals to AS1530 Part 7, compliant with AS6905 on proprietary door assemblies
- Conforms with BCA Specification C3.4 smoke sealing requirements
- Acoustically tested in accordance with AS1191, ISO140.3 & ISO10140-2
- Durability tests demonstrating over 1,000,000 open & close cycles



For more product information please scan QR code or visit www.kilargo.com.au/ourproducts/is8035si/

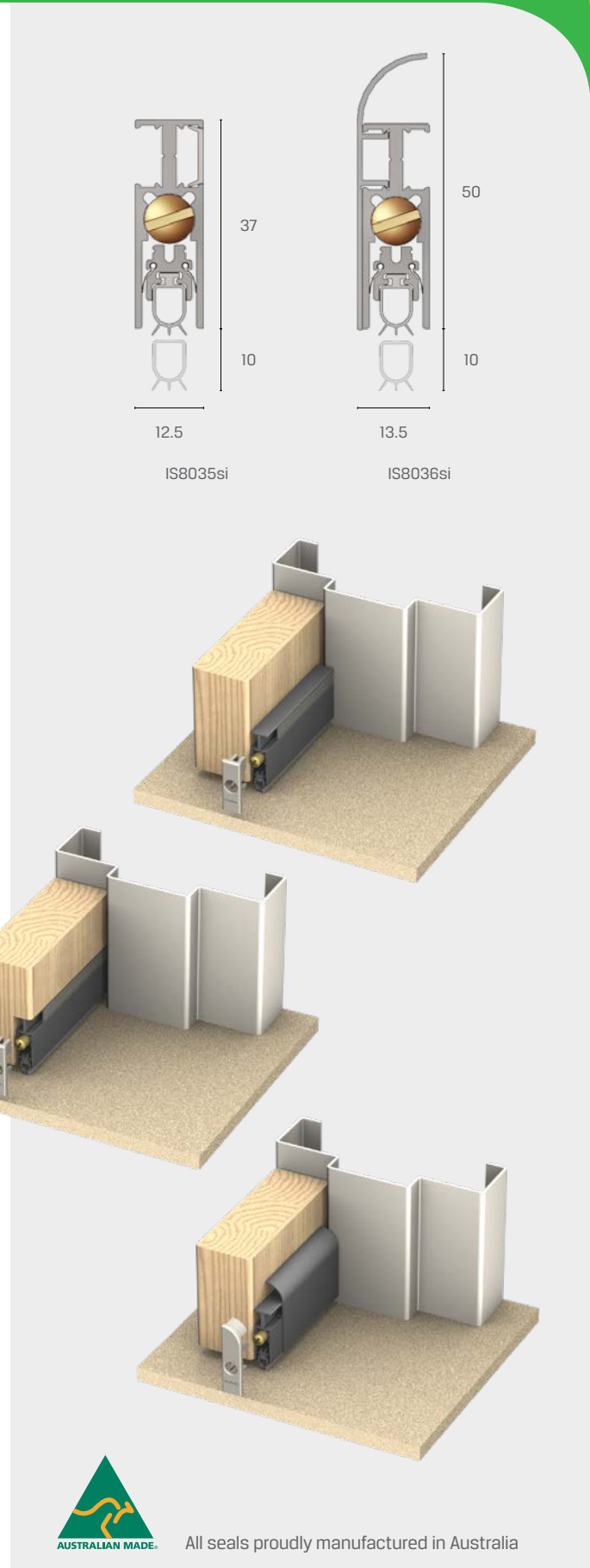

All seals proudly manufactured in Australia

Automatic Door Bottom Seals

IS8090si



A heavy duty, automatic door bottom seal which can be semi-rebated or facefixed to the bottom edge of single action doors. The seal has a spring loaded mechanism which lifts the seal clear of the floor as soon as the door is opened. Pressure against the door jamb on the adjustable brass strike button operates the seal automatically

Face-fixed: The seal is fixed to the face of the door bottom using the fixing screws provided. A set of rigid push-fit reinforced nylon end plates ensure longevity of the seal mechanism.

Semi-rebated: When the seal is to be semi-rebated, the seal is mounted into a stepped rebate: a 44mm deep x 21mm wide machined groove (for the bottom section), plus a 25mm deep x 3mm wide machined recess (for the top flange), on the side of the door to which the seal will be positioned. The seal can be screw-fixed into position through the flange and fitted with cast aluminium end plates.

The seal contains a high efficiency mechanism to assist with the closing force requirements detailed in AS1428/1 (Design for Access and Mobility).

Gap size

- Min. 3mm / max. 15mm

Standard lengths

- 450mm
- 610mm
- 820mm
- 920mm
- 1070mm
- 1220mm
- 1500mm

(*Longer length available to special order up to a maximum 1600mm)

IS8090si maximum allowable cut-back sizes:

- 450mm seal cuts to 275mm
- 610mm seal cuts to 450mm
- 820mm seal cuts to 610mm
- 920mm seal cuts to 610mm
- 1070mm seal cuts to 920mm
- 1220mm seal cuts to 1070mm
- 1500mm seal cuts to 1220mm

(*Seals can be cut on site to exact dimension)

Standard colours

- Silver anodised aluminium with grey end plates (or cast aluminium end plates) and grey silicone gasket
- Black anodised aluminium with black end plates (or cast aluminium end plates) and black silicone gasket

Approval/s

- Fire tested to AS1530 Part 4 in accordance with AS1905 Part 1
- Certifications GVY1.R26629, GVWZ.R26629, GVWZ7.R26629
- Medium temperature smoke leakage approvals to AS1530 Part 7, compliant with AS6905 on proprietary door assemblies
- Conforms with BCA Specification C3.4 smoke sealing requirements
- Acoustically tested in accordance with AS1191, ISO140.3 and ISO10140-2
- Durability tests demonstrating over 1,000,000 open & close cycles

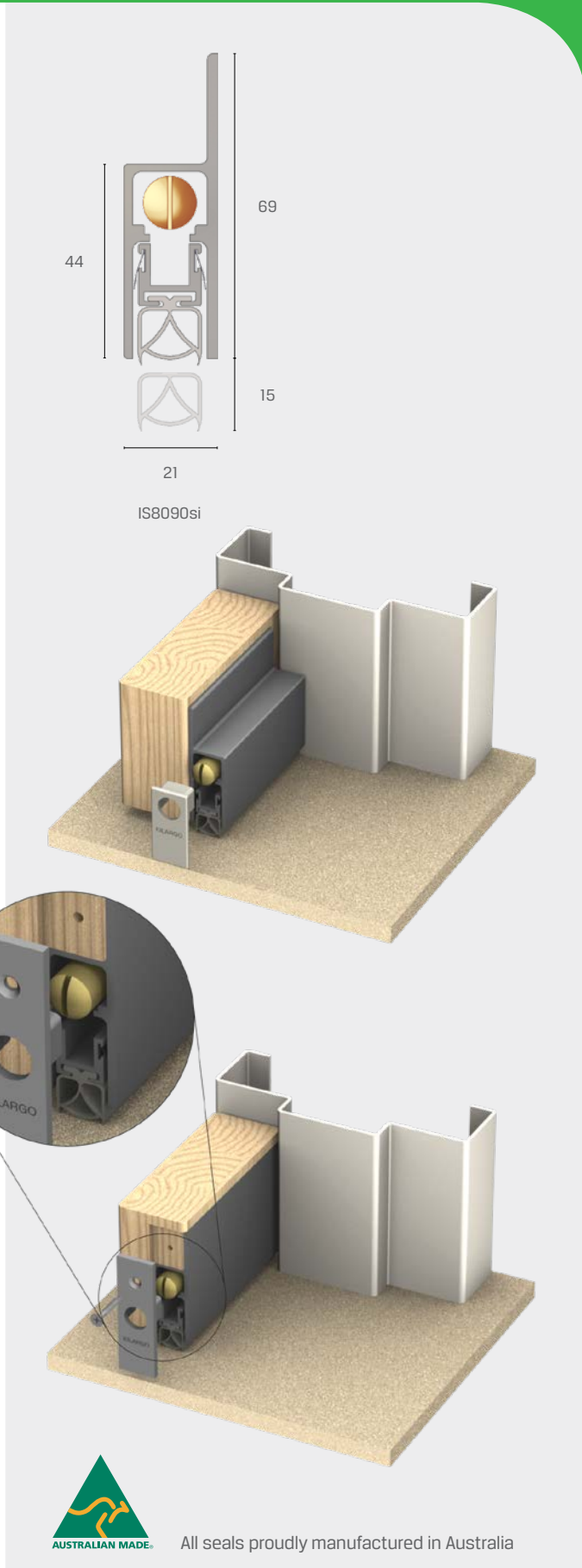

For more product information please scan QR code or visit www.kilargo.com.au/ourproducts/is8090si/



All seals proudly manufactured in Australia

IS8091si



A heavy duty, automatic door bottom seal which is face-fixed to the bottom edge of single action doors. The seal has a spring loaded mechanism which lifts the seal clear of the floor as soon as the door is opened. Pressure against the door jamb on the adjustable brass strike button operates the seal automatically.

The seal is fixed to the face of the door bottom using the fixing screws provided. A set of rigid push-fit reinforced nylon end plates ensure longevity of the seal mechanism. An aesthetic, architectural aluminium cover plate, provides an 'easy to clean' surface for clean-room environments.

The seal contains a high efficiency mechanism to assist with the closing force requirements detailed in AS1428/1 (Design for Access and Mobility).

Gap size

- Min. 3mm / max. 15mm

Standard lengths

- 450mm
- 610mm
- 820mm
- 920mm
- 1070mm
- 1220mm
- 1500mm

(*Longer length available to special order up to a maximum 1600mm)

IS8091si maximum allowable cut-back sizes:

- 450mm seal cuts to 275mm
- 610mm seal cuts to 450mm
- 820mm seal cuts to 610mm
- 920mm seal cuts to 610mm
- 1070mm seal cuts to 920mm
- 1220mm seal cuts to 1070mm
- 1500mm seal cuts to 1220mm

(*Seals can be cut on site for exact dimension)

Standard colours

- Silver anodised aluminium with grey end plates and grey silicone gasket. (Black end plates and black silicone gasket also available upon request.)

Approval/s

- Fire tested to AS1530 Part 4 in accordance with AS1905 Part 1
- Certifications GYI.R26629, GVWZ.R26629, GVWZ7.R26629
- Medium temperature smoke leakage approvals to AS1530 Part 7, compliant with AS6905 on proprietary door assemblies
- Conforms with BCA Specification C3.4 smoke sealing requirements
- Acoustically tested in accordance with AS1191, ISO140.3 and ISO10140-2
- Durability tests demonstrating over 1,000,000 open & close cycles

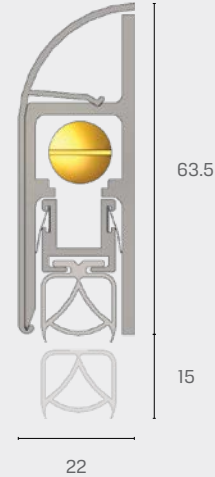

IS8091si

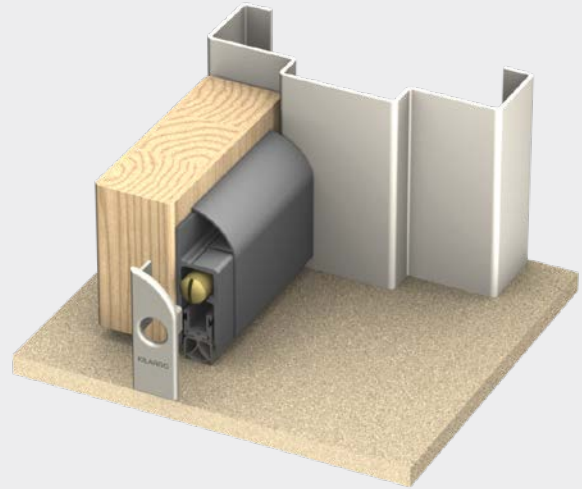

For more product information please scan QR code or visit www.kilargo.com.au/ourproducts/is8091si/



All seals proudly manufactured in Australia

Automatic Door Bottom Seals

IS8100si



A heavy duty, automatic door bottom seal which is fully-mortised into the bottom edge of single action doors. The seal has a spring loaded mechanism which lifts the seal clear of the floor as soon as the door is opened. Pressure against the door jamb on the adjustable brass strike button operates the seal automatically.

The seal is mounted into a 43mm deep x 21mm wide machined groove along the underside of the door. The seal is screw-fixed into position through the mounting flanges. Aesthetic, rigid reinforced nylon push-fit end plates (or screw-fixed cast aluminium end plates) ensure longevity of the seal mechanism.

The seal contains a high efficiency mechanism to assist with the closing force requirements detailed in AS1428/1 (Design for Access and Mobility).

Gap size

- Min. 3mm / max. 15mm

Standard lengths

- 450mm
- 610mm
- 820mm
- 920mm
- 1070mm
- 1220mm
- 1500mm

(*Longer length available to special order up to a maximum 1600mm)

IS8100si maximum allowable cut-back sizes:

- 450mm seal cuts to 275mm
- 610mm seal cuts to 450mm
- 820mm seal cuts to 610mm
- 920mm seal cuts to 610mm
- 1070mm seal cuts to 920mm
- 1220mm seal cuts to 1070mm
- 1500mm seal cuts to 1220mm

(*Seals can be cut on site for exact dimension)

Standard colours

- Silver anodised aluminium with grey reinforced nylon or cast-aluminium end plates and grey silicone gasket. (Black reinforced nylon or cast aluminium end plates and black silicone gaskets also available upon request.)

Approval/s

- Fire tested to AS1530 Part 4 in accordance with AS1905 Part 1
- Certifications GVY1.R26629, GVWZ.R26629, GVWZ7.R26629
- Conforms with BCA Specification C3.4 smoke sealing requirements
- Acoustically tested in accordance with AS1191, ISO140.3 and ISO10140-2
- Durability tests demonstrating over 1,000,000 open & close cycles

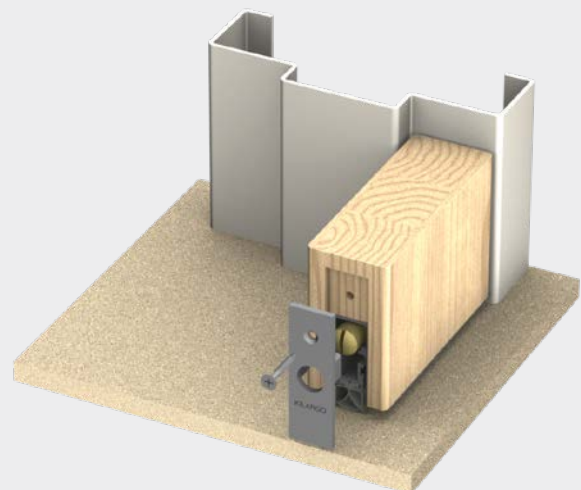
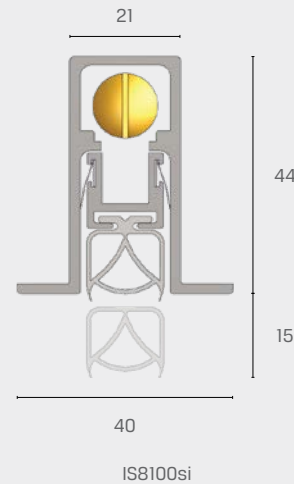

For more product information please scan QR code or visit www.kilargo.com.au/ourproducts/is8100si/



All seals proudly manufactured in Australia

IS8110si



A fully-mortised, automatic "flat back" seal to suit installation to aluminium door rails for single action doors. It operates automatically by a spring loaded mechanism which lifts the seal clear of the floor as soon as the door is opened by a few millimetres. The seal operates automatically by pressure against the door jamb on its adjustable strike button.

Standard lengths

- 610mm
- 820mm
- 920mm
- 1070mm
- 1220mm

IS8110si maximum allowable cut-back sizes:

- 610mm seal cuts to 580mm
- 820mm seal cuts to 610mm
- 920mm seal cuts to 610mm
- 1070mm seal cuts to 920mm
- 1220mm seal cuts to 1070mm

(*Seals can be cut on site for exact dimension)

Standard colours

- Silver anodised aluminium with grey silicone rubber compression gaskets

Approval/s

- Certifications GVI.R26629, GVWZ.R26629, GVWZ7.R26629
- Conforms with BCA Specification C3.4 smoke sealing requirements
- Acoustically tested in accordance with AS1191, ISO140.3 and ISO10140-2
- Durability tests demonstrating over 1,000,000 open and close cycles

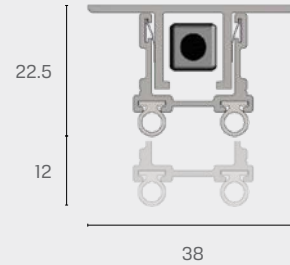

IS8110si

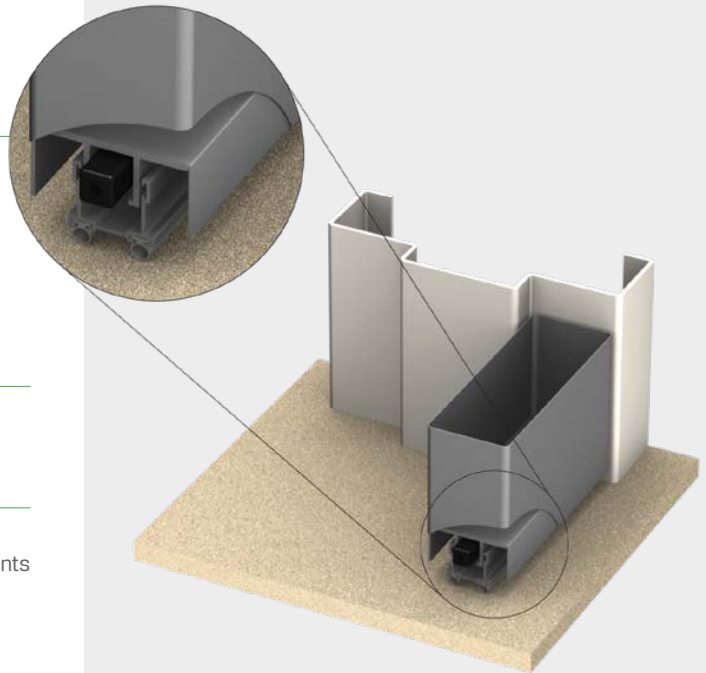

For more product information please scan QR code or visit www.kilargo.com.au/ourproducts/is8110si/



All seals proudly manufactured in Australia

Automatic Door Bottom Seals

IS8210si



A rebated automatic door bottom seal for single action doors which is spring loaded to swing clear of the floor as soon as the door is opened by a few millimetres. The unique "swing-seal" operates automatically by pressure against the door jamb on its adjustable strike button.

The seal is mounted into a 10mm deep x 31mm wide machined groove along the underside of the door. Aesthetic, nylon push-fit end plates ensure longevity of the seal mechanism.

Standard lengths

- 620mm
- 720mm
- 820mm
- 920mm
- 1020mm
- 1220mm

IS8210si maximum allowable cut-back sizes:

- 620mm seal cuts to 520mm
- 720mm seal cuts to 620mm
- 820mm seal cuts to 720mm
- 920mm seal cuts to 820mm
- 1020mm seal cuts to 920mm
- 1220mm seal cuts to 1020mm

(*Seals can be cut on site for exact dimension)

Standard colours

- Silver anodised aluminium with grey silicone rubber gasket and grey reinforced nylon push-fit end plates

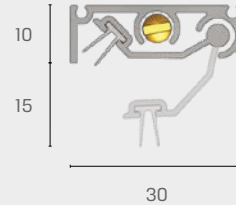

IS8210si

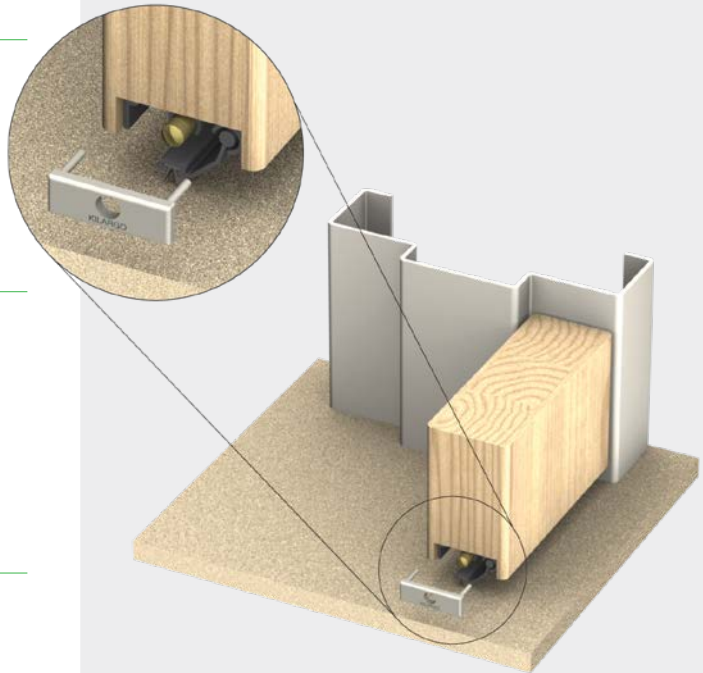

For more product information please scan QR code or visit www.kilargo.com.au/ourproducts/is8210si/



All seals proudly manufactured in Australia

IS8520si



A heavy duty, automatic door bottom seal designed for high-performance acoustic door systems. This seal can be face-fixed, semi-rebated or fully mortised into the bottom edge of single action doors. The seal has a spring loaded mechanism which lifts the seal clear of the floor, in a parallel motion, as soon as the door is opened. Pressure against the door jamb on the adjustable brass strike button operates the seal automatically.

Face-fixed: The seal is fixed to the face of the door bottom using the long fixing screws provided. (See detailed fitting instructions). A set of glass-filled, reinforced nylon end plates ensure longevity of the seal mechanism.

Semi-rebated: When the seal is to be semi-rebated, the seal is mounted into a stepped rebate: a 44mm deep x 21mm wide machined groove on the side of the door to which the seal will be positioned. The seal can be screw-fixed into position and fitted with the cast-aluminium end plates provided.

Fully-mortised: When the seal is to be fully-mortised, the seal is mounted into a 44mm deep x 21mm wide machined groove and screwfixed back into the door stiles via the cast-aluminium end plates, holding the seal in place.

Gap size

- Min. 6mm / max. 15mm

Standard lengths

- 420mm
- 520mm
- 610mm
- 820mm
- 920mm
- 1070mm
- 1220mm
- 1500mm

(*Longer lengths available to special order)

IS8520si maximum allowable cut-back sizes:

- 420mm seal cuts to 275mm
- 520mm seal cuts to 420mm
- 610mm seal cuts to 520mm
- 820mm seal cuts to 610mm
- 920mm seal cuts to 820mm
- 1070mm seal cuts to 920mm
- 1220mm seal cuts to 1070mm
- 1500mm seal cuts to 1220mm

(*Seals can be cut on site for exact dimension)

Standard colours

- Silver anodised aluminium with grey reinforced nylon or cast-aluminium end plates and grey silicone gasket. (Black reinforced nylon or cast aluminium end plates and black silicone gaskets also available upon request.)

Approval/s

- Fire tested to AS1530 Part 4 in accordance with AS1905 Part 1
- Certifications GVIY.R26629, GVWZ.R26629, GVWZ7.R26629
- Medium temperature smoke leakage approvals to AS1530 Part 7, compliant with AS6905 on proprietary door assemblies
- Conforms with BCA Specification C3.4 smoke sealing requirements
- Acoustically tested in accordance with AS1191, ISO140.3 and ISO10140-2
- Durability tests demonstrating over 1,000,000 open & close cycles



For more product information please scan QR code or visit www.kilargo.com.au/ourproducts/is8520si/

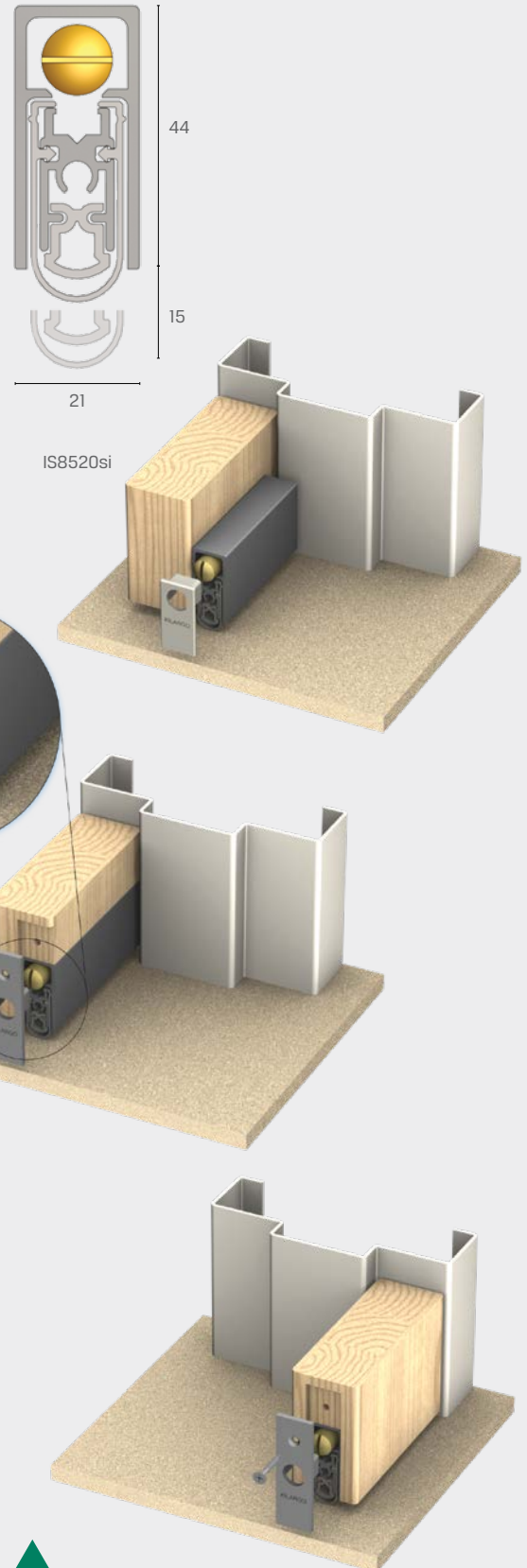

All seals proudly manufactured in Australia

Automatic Door Bottom Seals

IS8530si



A heavy duty, automatic door bottom seal, designed for high-performance acoustic door systems, which is fully mortised into the bottom of single action doors. The seal has a spring loaded mechanism which lifts the seal clear of the floor, in a parallel motion, as soon as the door is opened.

Pressure against the door jamb on the adjustable brass strike button operates the seal automatically. The seal is mounted into a 43mm deep x 21mm wide machined groove along the underside of the door. The seal is screw-fixed into position through the mounting flanges. Aesthetic, screw-fixed cast-aluminium end plates ensure longevity of the seal mechanism.

Gap size

- Min. 6mm / max. 15mm

Standard lengths

- 420mm
- 520mm
- 610mm
- 820mm
- 920mm
- 1070mm
- 1220mm
- 1500mm

(*Longer lengths available to special order)

IS8530si maximum allowable cut-back sizes:

- 420mm seal cuts to 275mm
- 520mm seal cuts to 420mm
- 610mm seal cuts to 520mm
- 820mm seal cuts to 610mm
- 920mm seal cuts to 820mm
- 1070mm seal cuts to 920mm
- 1220mm seal cuts to 1070mm
- 1500mm seal cuts to 1220mm

(*Seals can be cut on site for exact dimension)

(*Longer lengths available to special order)

Standard colours

- Silver anodised aluminium with cast-aluminium end plates and grey silicone gasket. (Black cast aluminium end plates and black silicone gaskets also available upon request.)

Approval/s

- Fire tested to AS1530 Part 4 in accordance with AS1905 Part 1
- Certifications GVYI.R26629, GVWZ.R26629, GVWZ7.R26629
- Medium temperature smoke leakage approvals to AS1530 Part 7, compliant with AS6905 on proprietary door assemblies
- Conforms with BCA Specification C3.4 smoke sealing requirements
- Acoustically tested in accordance with AS1191, ISO140.3 and ISO10140-2
- Durability tests demonstrating over 1,000,000 open & close cycles



For more product information please scan QR code or visit www.kilargo.com.au/ourproducts/is8530si/

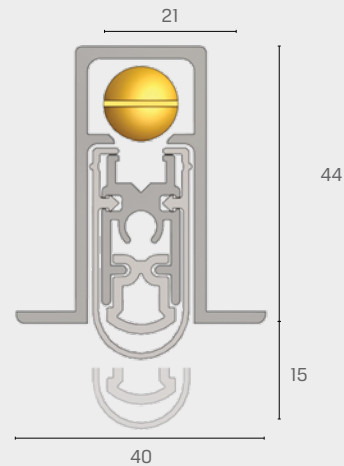

IS8530si

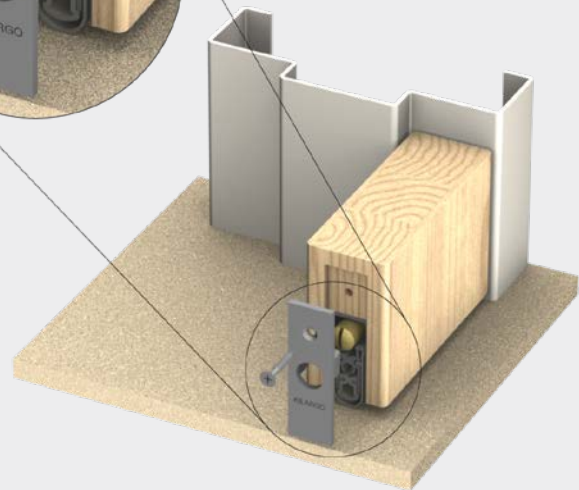

All seals proudly manufactured in Australia

Location: Brisbane, Queensland

Client: Queensland Government, QLD Health

Architect: Conrad Gargett & Lyons

Builder: Lend Lease (formerly Abigroup)

Completion: 2014



Having opened in November 2014, the Lady Cilento Children’s Hospital is now the primary specialist paediatric hospital for 4.5 million residents of Queensland.

About the project

Located adjacent to the existing Mater Hospital Campus at Stanley Street, South Brisbane, the new hospital comprises 12 clinical levels, four basement levels and 359 beds. This incredible new development for Queensland has a total floor area in excess of 110,000m².

Delivered within a highly constrained and busy site in South Brisbane, this striking building incorporates an innovative tree trunk and branch design and features an emphasis on environmentally sustainable design.

The simple and smart solution

With our long track record in developing innovative solutions for the health care sector, Kilargo was able to assure patient comfort and safety with our range of door seals. Our project partners also appreciated our local manufacturing capabilities, which provided exceptional quality while cutting down on lead times.

An onsite energy plant also required specific acoustic and smoke criteria to be met by robust, high performing seals. Our perimeter and astragal seals, in stylish neutral colours, were also chosen because they secure effectively to door peripheries to provide an excellent seal against noise, light, smoke and dust.

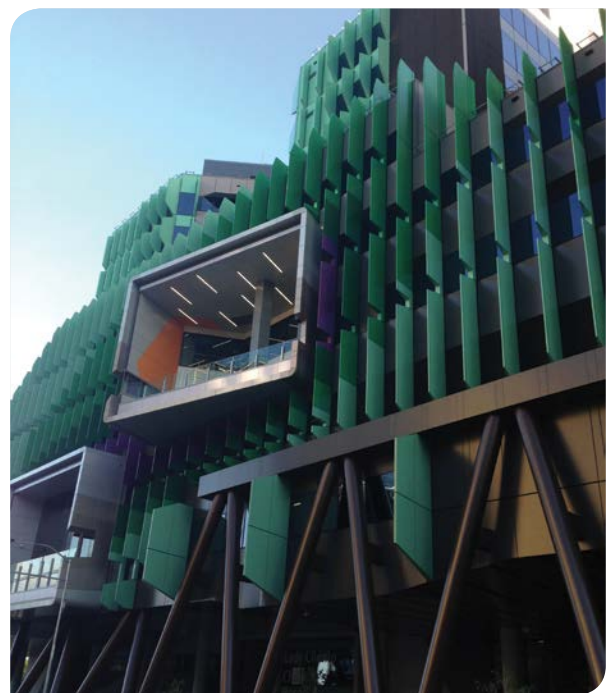

9000 SERIES

Specialty Seals

-  Trapping fingers in hinged doors can cause horrendous injuries, especially in locations where children are present. The range of Kilargo finger guard seals can provide the deterrent.

IS9010

An overhead drip guard designed to channel rain water away from exposed doors, particularly those which open outward.

An aesthetic PVC cover strip conceals the screw line. Suitable for single and double leaf doors, sliding doors, roller shutter doors, plus tilt-panels.

Standard lengths

- 1000mm
- 2250mm
- Also available in: 250mm increments from 1000mm to 3000mm

Standard colours

- Silver anodised aluminium with grey PVC cover strip

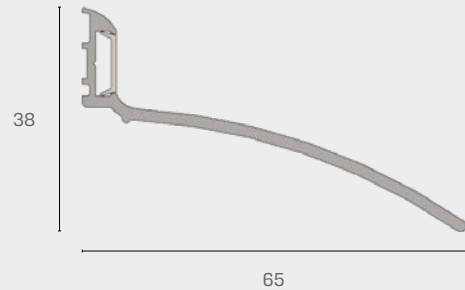

IS9010

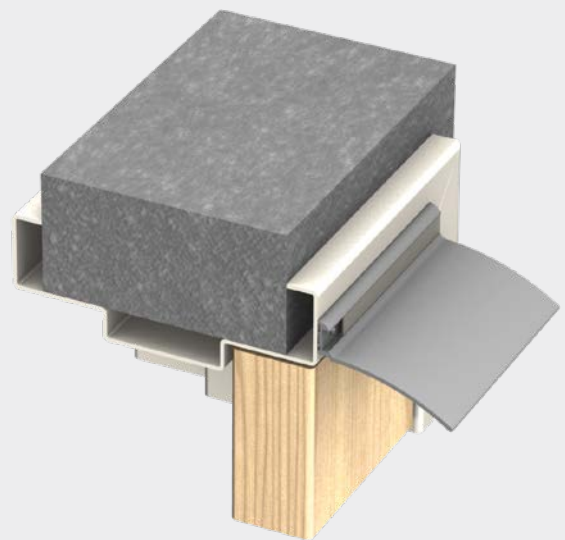

For more product information please scan QR code or visit www.kilargo.com.au/ourproducts/is9010/



All seals proudly manufactured in Australia

IS9050, IS9055, IS9070 Finger Guard Safety Seals

Trapping fingers in hinged doors can cause very serious injuries, particularly in locations where young children are present.

The Kilargo finger guard seals provide a deterrent. These seals can assist in providing protection on both sides of the door by using the IS9050 or IS9055 on the hinge knuckle side and the IS9070 on the hinge cavity side (opening / push side) of the door.

Note: These finger guard seals can assist in reducing the risk of finger pinch injuries on the hinge side of the door, by covering this void with a flexible rubber gasket. Kilargo does not recommend the installation of IS9070 on aluminium door frame systems.

Standard lengths

- 2250mm
- Also available in: 250mm increments from 1000mm to 3000mm

Standard colours

- Silver anodised aluminium with grey PVC cover strip and black gasket
- Black anodised aluminium with black PVC cover strip and black gasket
- Brown, grey and cream colour gaskets available to special order
- IS9055 is only available in black & grey

*Note: The IS9070 seal when fitted to hinged doors, has a maximum opening limitation of 110 degrees. Kilargo does not recommend the installation of IS9070 on aluminium door frame systems.

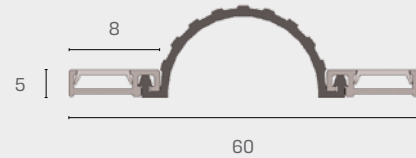
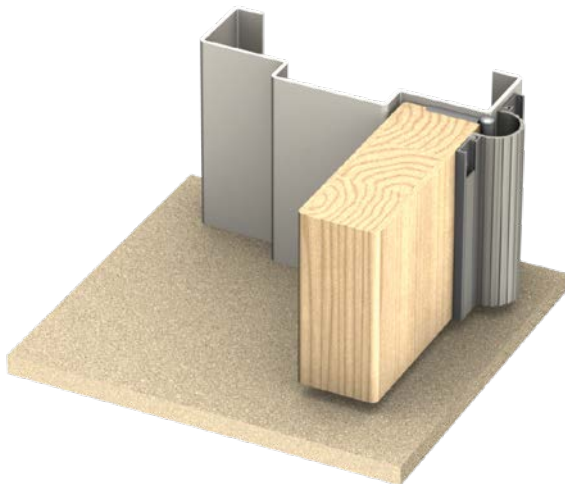

IS9050 Finger Guard Seal - hinge position

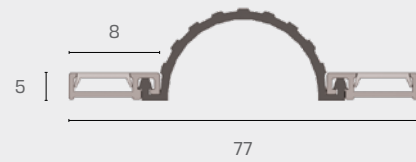

IS9055 Finger Guard Seal - hinge position

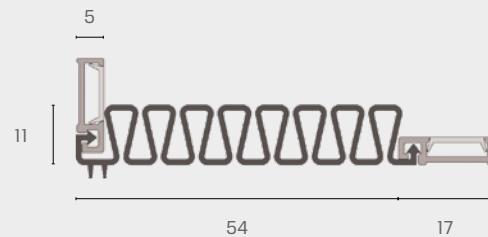

IS9070 Finger Guard Seal

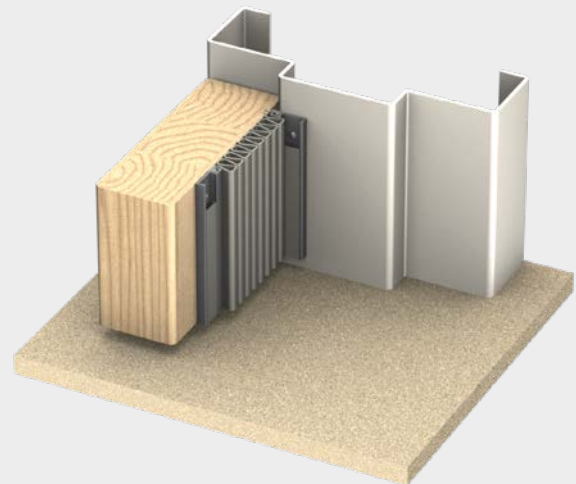

For more product information please scan QR code or visit www.kilargo.com.au/ourproducts/is9050/











All seals proudly manufactured in Australia

IS9570 (ALUmini) for push side of door

ALUmini is a durable and stylish retrofit finger guard that shields fingers from becoming trapped.

The specialty product is part of Kilargo's architectural seals range and proves more effective than alternatives by filling the hinge gap rather than simply covering it.

ALUmini is:

-  **Slimline**
Taking up just 80mm of space on the door and works on doors with a stile as little as 90mm
-  **Versatile**
It can be fitted to most doors, including retro-fitting to older frames
-  **Flexible**
Offering an 180° opening angle
-  **Quick**
Taking less than five minutes to install
-  **Subtle**
There's almost no impact on the clear opening width
-  **Good looking**
The sleek aluminium finish complements most existing decor
-  **Durable**
Its robust construction can withstand heavy impacts
-  **Long-lasting**
The quality manufacture means it lasts longer than other finger guards
-  **Safe**
Through its innovative circular profile and retracting fabric

Specification

- Gap-filling aluminium and fabric retrofit finger guard for doors.
- Retrofit finger guard with patented gap-filling, finger ejection system (offering improved safety).
- Durable aluminium body and fabric finger ejection system, for nominal 45mm doors opening up to 180 degrees.
* Standard length 1925mm
- As standard - SAA finish, charcoal-grey retracting fabric, including screw fixings.

*Note: Kilargo does not recommend the installation of ALUmini on aluminium door frame systems.

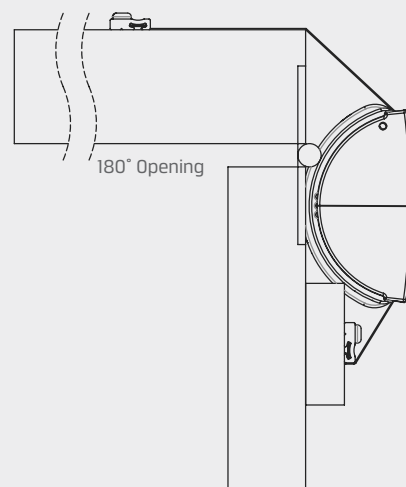
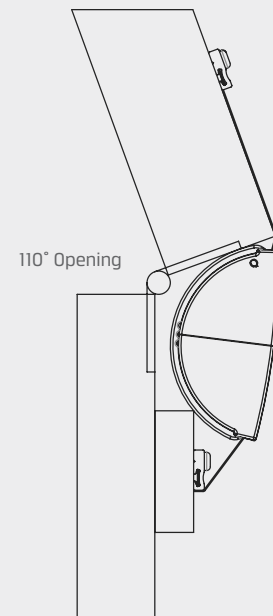
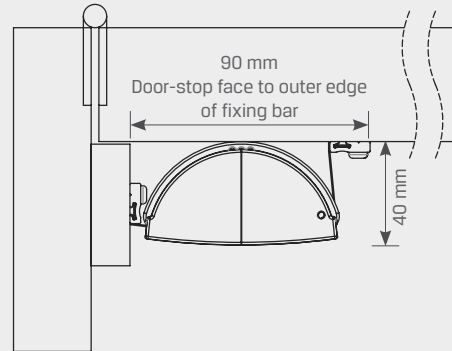

For more product information please scan QR code or visit www.kilargo.com.au/ourproducts/is9570-alumini/



All seals proudly manufactured in Australia



ALUmini Safety to count on

Be in safe hands with ALUmini finger guard

We're always searching for new heights in safety. So we've introduced ALUmini, an architectural safety seal that shields fingers from being trapped in door hinges. Unlike alternative products, ALUmini doesn't simply cover a door's hinge gap, it fills it with its circular profile and retractable fabric. Able to be retrofitted with ease, it's perfect for childcare centres, schools and other educational facilities.

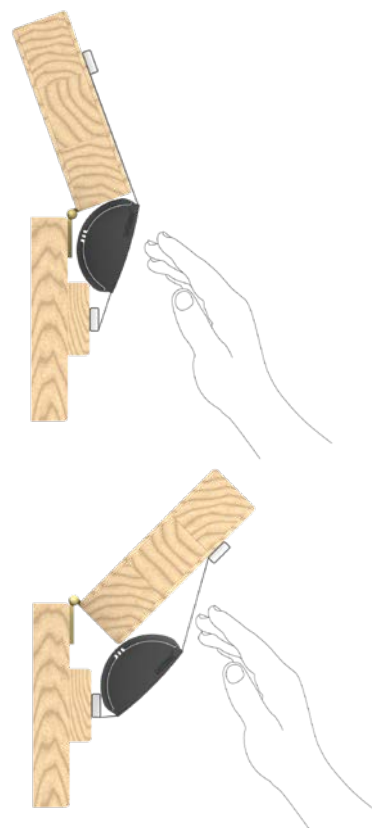

Talk to us today!

www.kilargo.com.au

Project Profile - Alexander & Anadara Apartments – Barangaroo South



Location: Barangaroo
Client: New South Wales Government
Architect: PTW & FJMT
Builder: Lend Lease
Completion: November 2015



A landmark in environmentally friendly development, the Barangaroo South residential and commercial development will be a world leader in sustainable urban living once completed.

With a goal to be Australia's first CBD project that is 'climate positive', this \$6 billion development includes a mix of high-rise and low-rise apartments, commercial office buildings, retail, food and beverage, community spaces and an international hotel, all overlooking the beautiful Sydney Harbour.

Part of the Clinton Climate Initiative in partnership with the US Green Building Council, this sustainable development will generate renewable energy onsite, include buildings rated 5 and 6 green stars, and offer a range of eco-friendly services.

Kilargo is a proud part of this world-leading project supplying our smart, sustainable sealing solutions.

The simple and smart solution

To maintain a world-class green rating, it is essential that all air-conditioned areas are effectively sealed and not affected by the influx of air in differing temperatures. Kilargo worked with the developer to select smart seals that will perform year round, keeping occupants warm in winter and cool in summer, enhancing energy efficiency and maintaining a welcoming environment.

With many automatic sliding doors throughout the buildings, Kilargo's bespoke silicone sweep seal was the ideal product. Sliding doors are often challenging to seal because of their lateral movement, however specific Kilargo seals utilised an angled silicone gasket to overcome gaps and ensure smoke, acoustic and energy containment.

And, because our premium products are Australian made, Kilargo has been able to deliver against short lead times and lend local expertise to this significant construction project.



INTUMESCENT FIRE & SMOKE SEALS

KP1004, KP1504, KP2004, KP2504, KP3006



Fire & Smoke Seals

Incorporated into the perimeter of fire door assemblies. When exposed to fire conditions, these strip seals expand to many times their original volume, sealing off the door perimeter to prevent the passage of hot smoke & other toxic gases.

Key Features

- Proven product with over 30 years in service history.
- Rebated into the door or frame for longevity in service.
- Decorative and protective PVC outer casing.
- Available in many sizes and finishes.
- Ideal for fire engineered solutions where extra protection is necessary for life safety.

Use With

Can be used in conjunction with a Kilargo medium temperature smoke seal such as the IS1212, IS1515 or IS0511 seal to maintain tenable conditions across all temperatures of smoke (ambient, medium and hot) in a typical fully developed fire scenario.

Materials

High performance sodium silicate based intumescent core encapsulated in a rigid flame retardant PVC outer casing, complete with aggressive self-adhesive tape backing.

Gap Size

Minimum 1mm - Maximum 3mm

The product sits flush with the edge of the door leaf or door frame edge.

Standard lengths

- 1000mm
- 2100mm
- 2400mm
- 2700mm
- 3000mm

Standard colours

- Black
- Grey
- (White & dark brown colours available to special order).

Fixing

The product fits into a groove made in the door frame or the edge of the door leaf and is secured using the self-adhesive tape backing.

Approval/s

- Fully tested to AS1530 Part 4 for up to 2 hours on proprietary fire door assemblies in accordance with AS1905 Part 1.

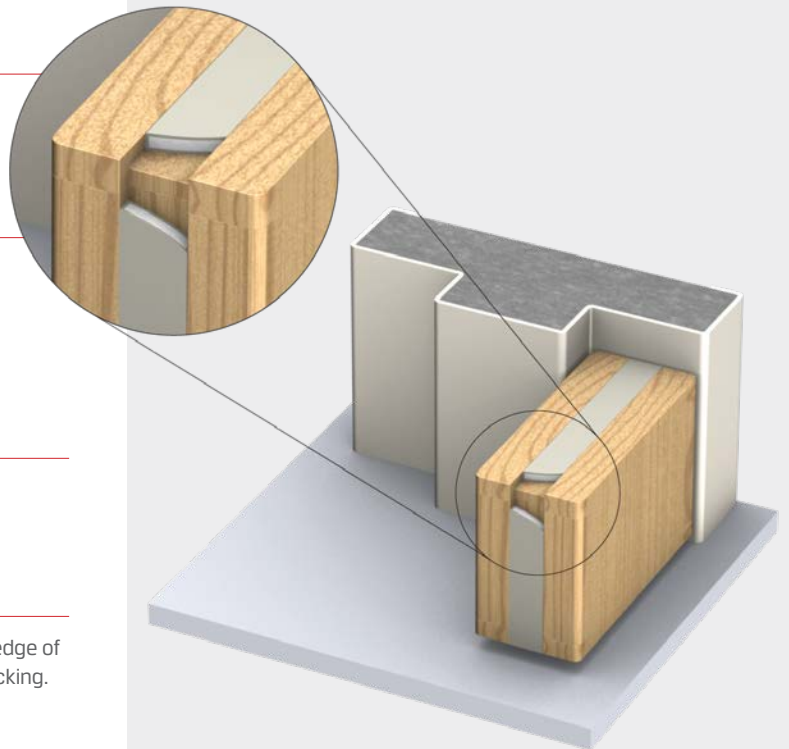
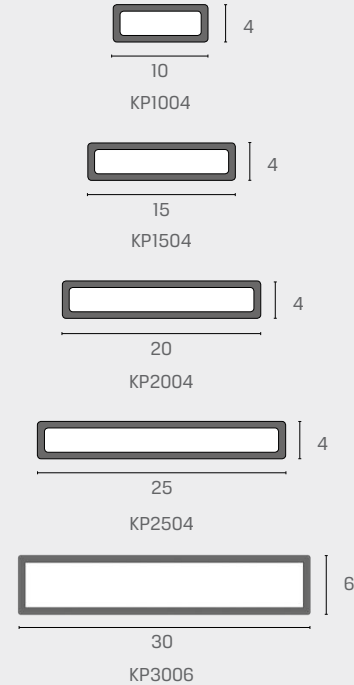

For more product information please scan QR code or visit www.kilargo.com.au/ourproducts/kp1004/



All seals proudly manufactured in Australia

Intumescent Fire & Smoke Seals

KP1504TS, KP2004TS



High performance sodium silicate based intumescent fire and smoke seal. The intumescent core is encapsulated in a flame-retardant PVC outer casing with centrally located twin smoke and acoustic fins. Incorporated into the perimeter of fire door assemblies. When exposed to fire conditions, these intumescent strip seals expand to many times their original volume, sealing off the door perimeter to prevent the passage of hot smoke and other toxic gases.

Key Features

- One seal only for fire and all temperatures of smoke.
- Rebated into the door or frame for longevity in service.
- Decorative and protective PVC outer casing.
- Ideal for fire engineered solutions where extra protection is necessary for life safety.

Materials

High performance sodium silicate based intumescent core encapsulated in a rigid flame retardant PVC outer casing with coextruded twin sealing fins. Supplied with aggressive self adhesive backing.

Gap Size

Minimum 2mm - Maximum 3mm

The product sits flush with the edge of the door leaf or door frame edge.

Standard lengths

- 1000mm
- 2100mm
- 2400mm
- 2700mm
- 3000mm

Standard fin height

4mm

Standard colours

- Black
- Grey

Fixing

The product is fitted into a groove in the door frame or the edge of the door leaf and is fixed using the self-adhesive tape backing.

Approval/s

- Fully tested to AS1530 Part 4 for up to 2 hours on proprietary fire door assemblies in accordance with AS1905 Part 1
- Medium temperature smoke leakage approvals to AS1530 Part 7, compliant with AS6905 on proprietary door assemblies
- Conforms with BCA Specification C3.4 smoke sealing requirements
- Acoustically tested in accordance with AS1191, ISO140.3 & ISO10140-2
- Independent tests have been conducted demonstrating over 100,000 open and close cycles without significant wear.

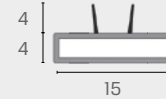

KP1504TS



KP2004TS

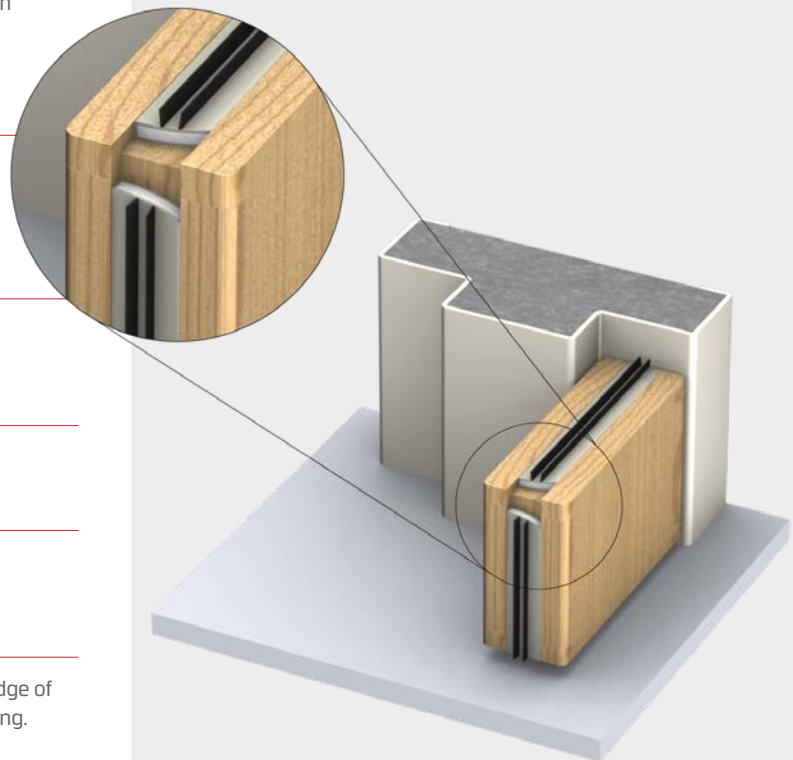

For more product information please scan QR code or visit www.kilargo.com.au/ourproducts/kp1504ts/



All seals proudly manufactured in Australia

KP3107, KP3107SS



Incorporated into proprietary fire door and life safety door assemblies to provide resistance against fully developed fires where hot flames, gases and smoke are at extreme temperatures.

Key Features

- Utilised in proprietary aluminium bullnose meeting stile sections.
- Decorative and protective PVC outer casing. 'SS' version has offset brush pile incorporated into profile to help provide resistance to smoke.
- Ideal for fire engineering solutions where fire (or fire & smoke) protection is necessary.

Use With

Used in conjunction with other Kilargo intumescent perimeter seals and door bottom seals, as tested on typical proprietary fire doors.

Materials

- **KP3107:** High performance sodium silicate based intumescent core encapsulated in a rigid flame retardant PVC outer casing, complete with aggressive self-adhesive tape backing.
- **KP3107SS:** KP3107 intumescent seal with incorporated, offset brush pile.

Gap Size

Minimum 1mm - Maximum 3mm
(Dependent on seal type and application)

- **KP3107:** This product sits flush with the edge of the door leaf or door frame edge.
- **KP3107SS:** This product is usually incorporated into proprietary fire door meeting stile sections.

Standard lengths

- 2100mm
- 2400mm
- 3000mm

Finish

- KP3107: Grey
- KP3107SS: Grey with black brush pile

Fixing

- **KP3107:** The product fits into a groove made in the edge of the door leaf, or door frame and is secured using the self-adhesive tape backing.
- **KP3107SS:** This product can be fitted into the proprietary aluminium sections of bullnose meeting stiles for double action fire doors.

Approval/s

- Fully tested to AS1530 Part 4 for up to 2 hours on proprietary fire door assemblies in accordance with AS1905 Part 1.

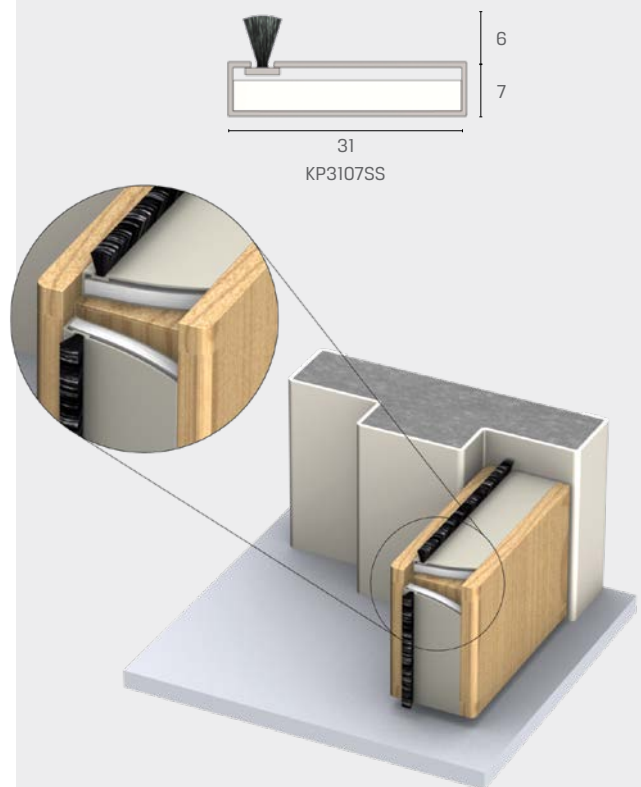
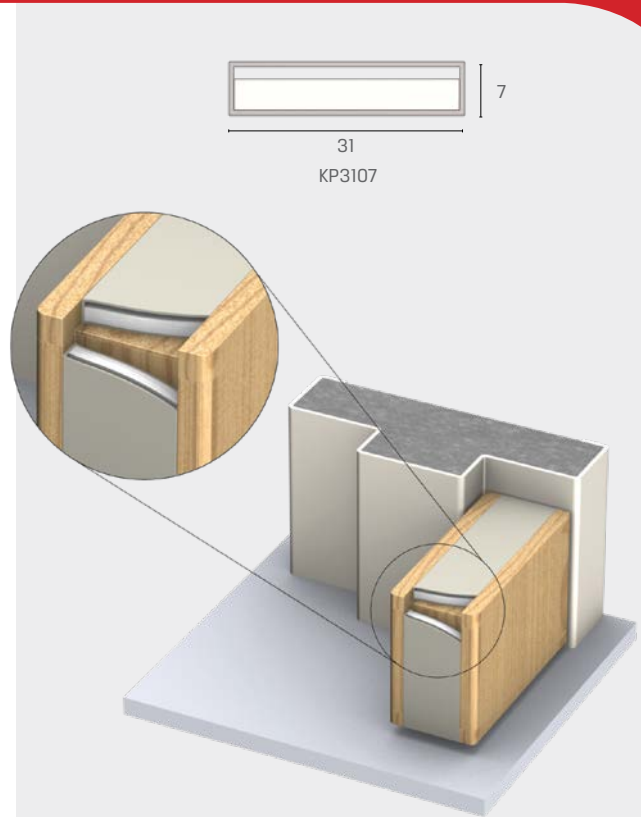

For more product information please scan QR code or visit www.kilargo.com.au/ourproducts/kp3107/



All seals proudly manufactured in Australia

KP3504TF



Incorporated into fire, smoke and life safety door assemblies to provide resistance against all stages of fire and smoke whilst also providing excellent acoustic properties.

Key Features

- Dual offset fin seals (TF) provides outstanding smoke and sound containment properties.
- Provides an ideal alternative for double swing pivot door assemblies, where the smoke seal can remain uninterrupted while the seal body is checked to allow for any door hardware.
- Simple self-adhesive / screw-fix application onto the bottom of the door.

Use With

Used in conjunction with a Kilargo 4000 Series threshold plate to provide a total door bottom sealing solution.

Materials

High performance intumescent core with a rigid PVC casing combined with dual elastomeric smoke and acoustic fins. Supplied with aggressive self adhesive backing.

Gap Size

10mm (dependent upon installation)

Standard lengths

820mm, 920mm, 1220mm
Other lengths to special order

Standard fin height

9mm

Standard colour

- Black

Fixing

The product is fitted to the underside of the door leaf using the aggressive self-adhesive backing tape and simple screw-fixing.

Approval/s

- Fully tested to AS1530 Part 4 for up to 2 hours on proprietary fire door assemblies in accordance with AS1905 Part 1
- Medium temperature smoke leakage approvals to AS1530 Part 7, compliant with AS6905 on proprietary door assemblies
- Conforms with BCA Specification C3.4 smoke sealing requirements
- Acoustically tested in accordance with AS1191, ISO140.3 & ISO10140-2.



KP3504TF

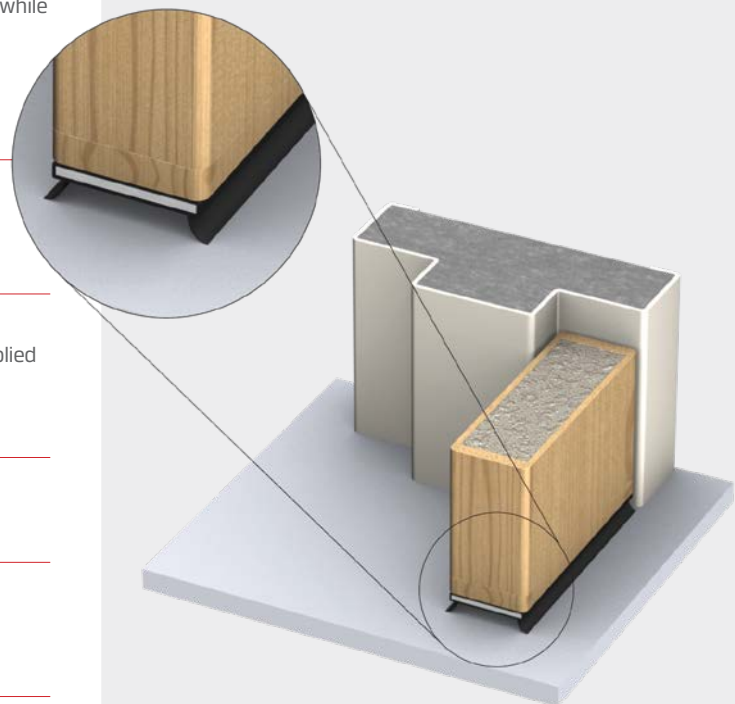

For more product information please scan QR code or visit www.kilargo.com.au/ourproducts/kp3504tf/



All seals proudly manufactured in Australia

KP4204TF



Fire & Smoke Seals

Incorporated into fire, smoke and life safety door assemblies to provide resistance against all stages of fire and smoke whilst also providing excellent acoustic properties.

Key Features

- Dual offset fin seals (TF) provides outstanding smoke and sound containment properties.
- Provides an ideal alternative for double swing pivot door assemblies, where the smoke seal can remain uninterrupted while the seal body is checked to allow for any door hardware.
- Tested on proprietary fire doors providing up to 2 hours fire resistance.
- Simple self-adhesive / screw-fix application onto the bottom of the door.

Use With

Used in conjunction with a Kilargo 4000 Series threshold plate to provide a total door bottom sealing solution.

Materials

High performance intumescent core with a rigid PVC casing combined with dual elastomeric smoke and acoustic fins. Supplied with aggressive self adhesive backing.

Gap Size

10mm (dependent upon installation)

Standard lengths

820mm, 920mm, 1220mm
Other lengths to special order.

Standard fin height

9mm

Standard colour

- Black

Fixing

The product is fitted to the underside of the door leaf using the aggressive self-adhesive backing tape and simple screw-fixing.

Approval/s

- Fully tested to AS1530 Part 4 for up to 2 hours on proprietary fire door assemblies in accordance with AS1905 Part 1
- Medium temperature smoke leakage approvals to AS1530 Part 7, compliant with AS6905 on proprietary door assemblies
- Conforms with BCA Specification C3.4 smoke sealing requirements
- Acoustically tested in accordance with AS1191, ISO140.3 & ISO10140-2

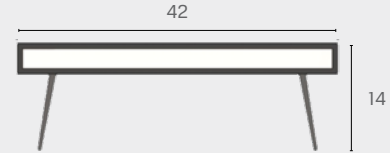

KP4204TF

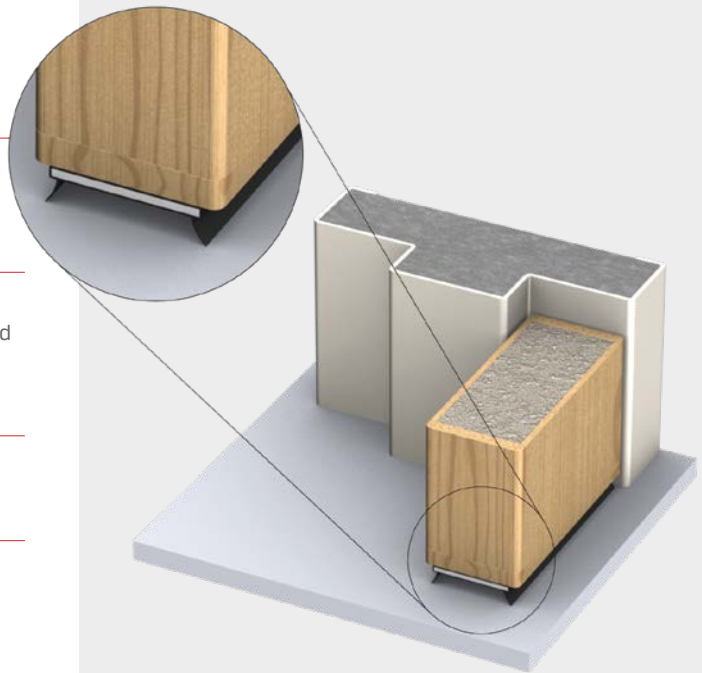

For more product information please scan QR code or visit www.kilargo.com.au/ourproducts/kp4204tf/



All seals proudly manufactured in Australia

KG1202 & KG1602



Applied to the perimeter of fire door assemblies. When exposed to fire conditions, these strip seals expand to many times their original volume, sealing off the door perimeter to prevent the passage of hot smoke and other toxic gases.

Key Features

- Easy retrofit installation.
- Simple self-adhesive application onto the door frame.
- Flexible seal is supplied in coils to minimize wastage when cutting lengths to size.
- Ideal for fire engineered solutions where extra fire protection is required.

Use With

Used in conjunction with a Kilargo door bottom solution, such as the IS8010si automatic door bottom seal or KP4204TF intumescent sweep type seal to provide a total door sealing solution.

Materials

Kilargo high performance, graphite based, intumescent core, supplied with aggressive self-adhesive backing tape.

Gap Size

Nominal 3mm perimeter gaps.

Dimensions

- KG1202: 12mm x 2mm
- KG1602: 16mm x 2mm

Standard lengths

- 50 metre coils

Standard colour

- Black

Fixing

This product can be simply retrofitted to a steel frame, or set into a mortised groove in the door frame or the edge of the door leaf, using the aggressive self-adhesive backing tape.

Approval/s

- Fully tested to AS1530 Part 4 for up to 2 hours on proprietary fire door assemblies in accordance with AS1905 Part 1.



Fire & Smoke Seals



For more product information please scan QR code or visit www.kilargo.com.au/ourproducts/kg1202/



All seals proudly manufactured in Australia

KG1602AS



Applied to the perimeter of fire door assemblies. When exposed to fire conditions, these strip seals expand to many times their original volume, sealing off the door perimeter to prevent the passage of hot smoke and other toxic gases. These seals also incorporate an offset fin to provide smoke control across all temperatures.

Key Features

- Offset fin seal (AS) provides outstanding smoke and sound containment properties.
- One seal only for fire and all temperatures of smoke.
- Simple self-adhesive application onto the door or frame.
- Flexible seal is supplied in coils to minimize wastage when cutting lengths to size.
- Ideal for fire engineering solutions where extra protection is required.

Use With

Used in conjunction with a Kilargo door bottom solution such as the IS8010si automatic door bottom or KP4204TF intumescent sweep type seal to provide a total door sealing system.

Materials

Kilargo high performance graphite based intumescent core with a co-extruded, asymmetric smoke and acoustic fin. Supplied with aggressive self adhesive backing.

Gap Size

Nominal 3mm

Standard lengths

50 metre coils

Standard colour

Black

Fixing

The product can be simply retro-fitted to a steel frame, or set into a morticed groove in the door frame or the edge of the door leaf, using the aggressive self-adhesive backing tape.

Approval/s

- Fully tested to AS1530 Part 4 for up to 2 hours on proprietary fire door assemblies in accordance with AS1905 Part 1

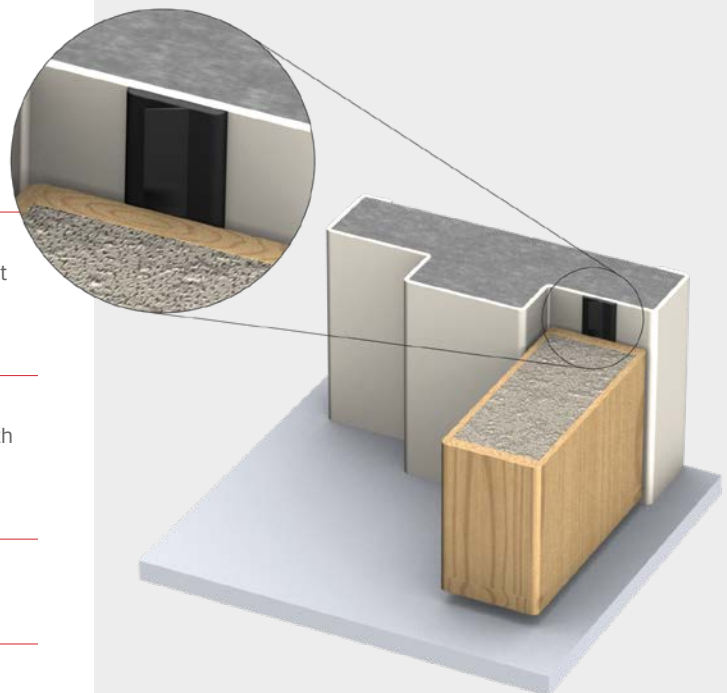
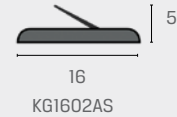

For more product information please scan QR code or visit www.kilargo.com.au/ourproducts/kg1602as/



All seals proudly manufactured in Australia

KG1612BW



This hybrid, intumescent fire & smoke seal is simply fitted onto the rebate of a door frame perimeter to provide resistance against fire, smoke, sound, draughts, dust and light.

Key Features

- Tested on proprietary fire doors for up to 2 hours fire resistance.
- Fits quickly and easily without removal of the door.
- Provides an excellent acoustic & smoke seal across all temperatures.
- Offers an outstanding acoustic performance.
- Simple self-adhesive application onto the door frame.
- Strategically located in the impact free zone of the opening.

Use With

Used in conjunction with a Kilargo door bottom solution such as the IS8010si automatic door bottom or KP3504TF seal to provide a total door sealing system.

Materials

Kilargo high performance graphite based intumescent core with PVC skin combined with an elastomeric sealing blade. Supplied with aggressive self adhesive backing tape on both flanges of the carrier.

Gap Size

Minimum 2mm - Maximum 3mm

Sizes

Door Sets:	Single	1 x 1000mm, 2 x 2100mm
	Long Single	1 x 1000mm, 2 x 2750mm
	Double	3 x 2100mm
	Long Double	1 x 2100mm, 2 x 2750mm

Standard lengths

1000mm, 2100mm, 2400mm, 2700mm, 3000mm

Standard colours

- Black
- White

Fixing

The product is fitted along the rebate of the door frame perimeter and applied using the integral self-adhesive backing tape.

Approvals

- Fully tested to AS1530 Part 4 for up to 2 hours on proprietary fire door assemblies in accordance with AS1905 Part 1
- Acoustically tested in accordance with AS1191, ISO140.3 & ISO10140-2.
- Medium temperature smoke leakage approvals to AS1530 Part 7 available on proprietary door assemblies

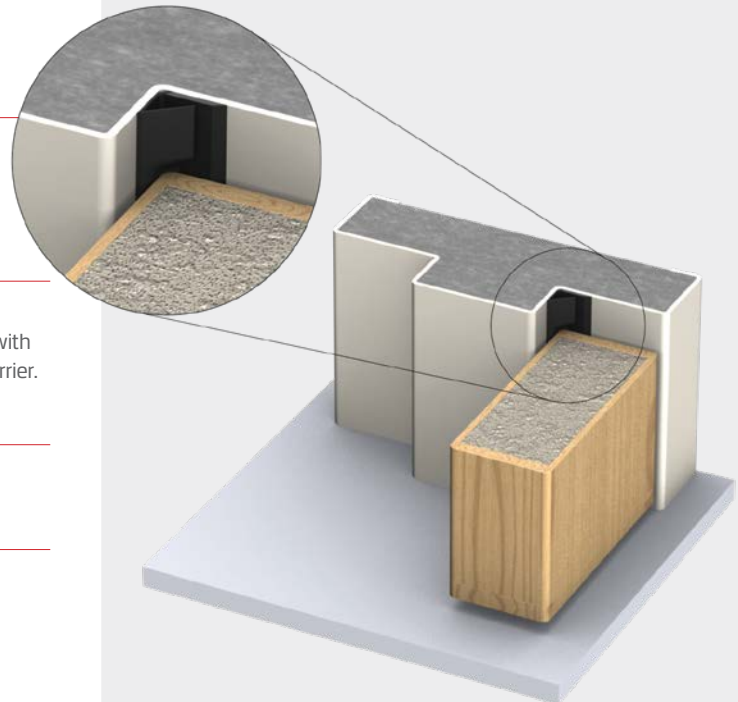

For more product information please scan QR code or visit www.kilargo.com.au/ourproducts/kg1612bw/



All seals proudly manufactured in Australia

KG2512BW



This hybrid, intumescent fire & smoke seal is simply fitted onto the rebate of a door frame perimeter to provide resistance against fire, smoke, sound, draughts, dust and light.

Key Features

- Tested on proprietary fire doors for up to 2 hours fire resistance.
- Fits quickly and easily without removal of the door.
- An excellent 'life safety' seal, providing an ideal fire engineered solution, limiting the spread of fire and smoke across all temperatures.
- With dual elastomeric fins, this seal also offers outstanding acoustic performance.
- Simple self-adhesive application onto the door frame.
- Strategically located in the impact free zone of the opening.

Use With

Used in conjunction with a Kilargo automatic door bottom seal for a complete life-safety sealing solution.

Materials

Kilargo high performance graphite based intumescent core with PVC skin combined with dual elastomeric sealing blades. Supplied with aggressive self adhesive backing tape on both flanges of the carrier.

Gap Size

Minimum 3mm- Maximum 5mm

Sizes

Door Sets: Single	1 x 1000mm, 2 x 2100mm
Long Single	1 x 1000mm, 2 x 2750mm
Double	3 x 2100mm
Long Double	1 x 2100mm, 2 x 2750mm

Standard lengths

1000mm, 2100mm, 2400mm, 2700mm, 3000mm

Standard colour

- Black

Fixing

The product is fitted along the rebate of the door frame perimeter and applied using the integral self-adhesive backing tape.

Approval/s

- Fully tested to AS1530 Part 4 for up to 2 hours on proprietary fire door assemblies in accordance with AS1905 Part 1
- Medium temperature smoke leakage approvals to AS1530 Part 7 available on proprietary door assemblies
- Acoustically tested in accordance with AS1191, ISO140.3 & ISO10140-2

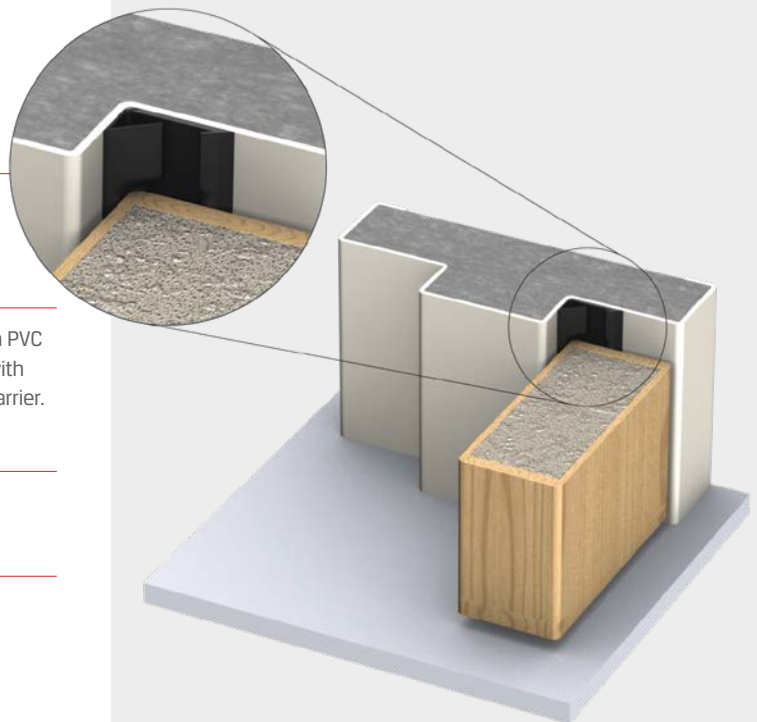
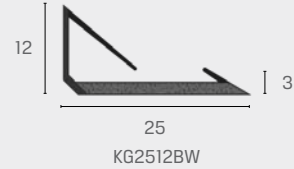

For more product information please scan QR code or visit www.kilargo.com.au/ourproducts/kg2512bw/



All seals proudly manufactured in Australia

FDMS-TP



Aluminium meeting stile seal set for proprietary single action fire door assemblies. Designed specifically for high performance smoke and sound containment for pairs of nom. 47mm fire doors.

Key Features

- New modern and aesthetic appearance.
- Incorporates intumescent fire and smoke sealing technology.
- Improves acoustic performance.
- Can be used to upgrade existing fire doors.
- Easy installation.
- Sold as complete assembly, including a T-Bar and plain aluminium section with intumescent strips and flexible silicone smoke seal.

Materials

Anodised aluminium astragals with integral high performance intumescent fire seals plus flame retardant silicone smoke and acoustic seal fitted to 'T' section.

Standard lengths

2135mm, 2440mm, 3050mm, 3500mm

Finish

Clear anodised finish with grey silicone seal insert.

Fixing

The Kilargo FDMS-T astragals come complete with the intumescent and silicone seal fitted. Simply cut to length and screw-fix to the respective door leaves.

Approval/s

- AS1530/4 fire tests with proprietary fire door assemblies.
- Medium temperature smoke leakage approvals to AS1530 Part 7 available on proprietary door assemblies
- Conforms with BCA Specification C3.4 smoke sealing requirements
- Acoustically tested in accordance with AS1191, ISO140.3 & ISO10140-2.

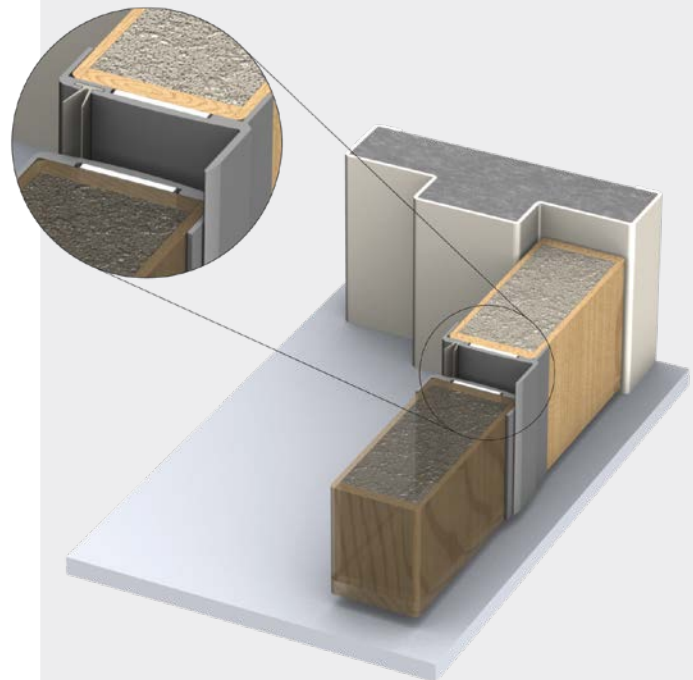
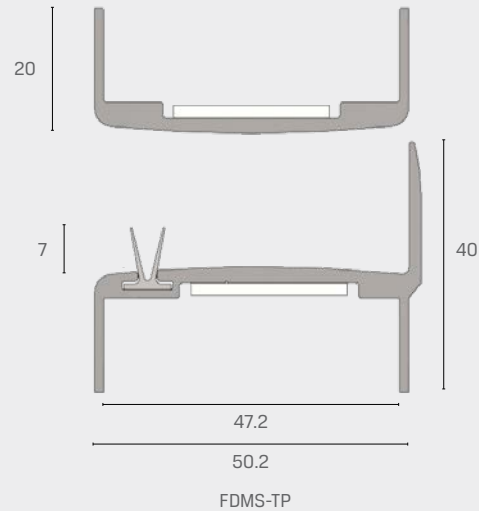

For more product information please scan QR code or visit www.kilargo.com.au/ourproducts/fdms-tp/



All seals proudly manufactured in Australia

FDMS-BB



Aluminium meeting stile seal set for proprietary double action fire door assemblies. Designed specifically for high performance smoke and sound containment for pairs of nom. 47mm fire doors.

Key Features

- New modern and aesthetic appearance.
- Incorporates intumescent fire and smoke sealing technology.
- Improves acoustic performance.
- Can be used to upgrade existing fire doors.
- Easy installation.
- Sold as complete assembly incorporating 2 identical aluminium sections and PVC encased intumescent seals with elastomeric smoke and acoustic fins.

Materials

Anodised aluminium astragals with integral high performance intumescent fire seals encapsulated in a rigid flame retardant PVC outer casing with a co-extruded single asymmetric smoke and acoustic fin.

Standard lengths

2135mm, 2440mm, 3050mm, 3500mm

Finish

Clear anodised finish with silver colour fire seal and black offset fin.

Fixing

The Kilargo FDMS-B bullnose stiles come complete with the aluminium sections and intumescent fire and smoke seals. Simply cut to length, screw aluminium sections onto the respective door leaves and insert the intumescent seals using aggressive self adhesive backing tape.

Approval/s

- Fully tested to AS1530 Part 4 for up to 2 hours on proprietary fire door assemblies in accordance with AS1905 Part 1
- Conforms with BCA Specification C3.4 smoke sealing requirements
- Acoustically tested in accordance with AS1191, ISO140.3 & ISO10140-2.

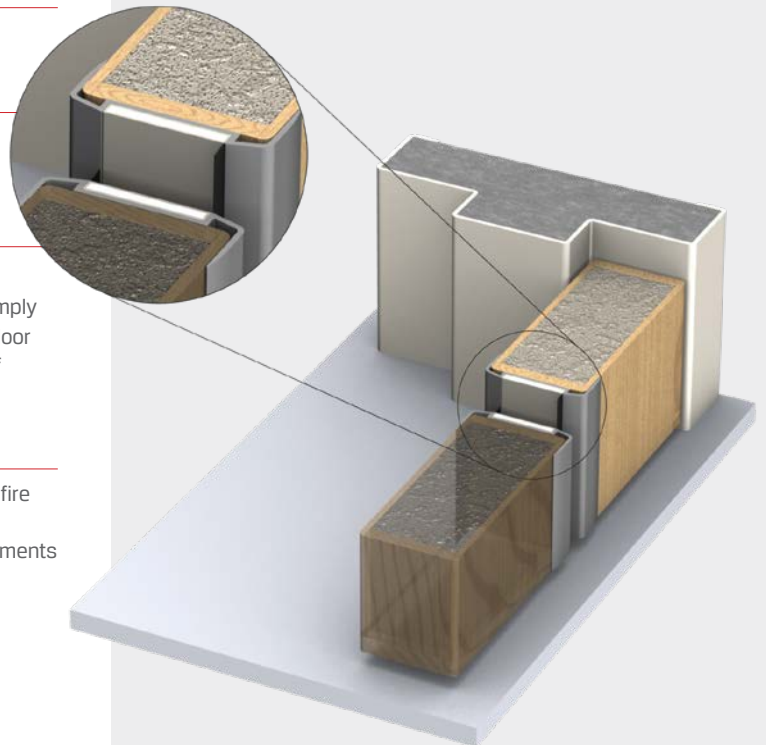
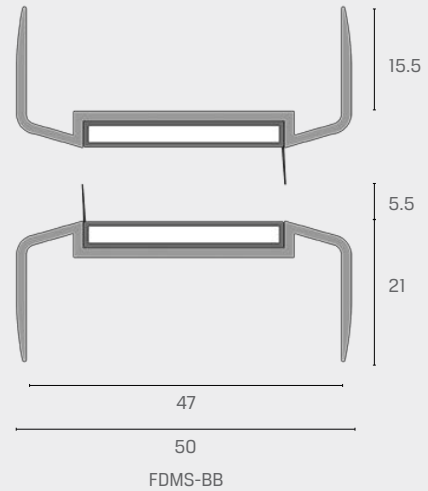

For more product information please scan QR code or visit www.kilargo.com.au/ourproducts/fdms-bb/



All seals proudly manufactured in Australia

Retrofit Intumescent Fire Door Bottom Upgrade Seals

FDBU20



Used to upgrade existing fire doors where door bottom gaps exceed the allowable 10mm as per AS1905/1.

Key Features

- Can provide up to 2 hours fire resistance when fitted to the bottom of proprietary fire doors.
- Non compliant fire doors can be salvaged.
- Avoids expensive door build-ups or door replacements.
- Cost-effective solution.
- Easy retro-fit installation.
- No need to remove the door during installation.

Use With

Although not required for upgrade work, the Kilargo 4000 Series Threshold Plates may be incorporated as part of the overall system for both aesthetic and disability compliance issues.

Materials

These products consist of an anodised aluminium profile, flame retardant smoke, draught and light excluding silicone gasket and integral high performance intumescent fire seals.

Gap Size

To seal gap sizes up to 20mm maximum, under nom. 35mm and 45mm proprietary doors.

Standard lengths

820mm, 920mm, 1220mm

Standard colours

Clear Anodised (Silver) with grey gaskets

Fixing

The FDBU20 is supplied with pre-drilled slotted holes and screws for easy application onto the bottom of door leaves.

Approval/s

- Fully tested to AS1530 Part 4 for up to 2 hours on proprietary fire door assemblies in accordance with AS1905 Part 1
- Conforms with BCA Specification C3.4 smoke sealing requirements

NB: Check with your door manufacturer for approvals.

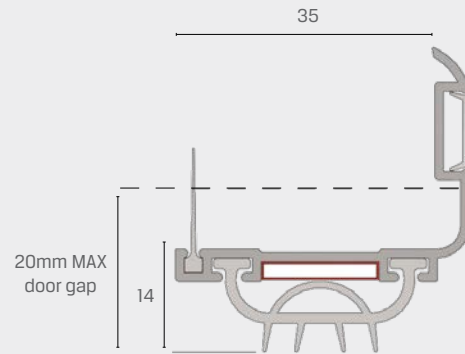

FDBU20

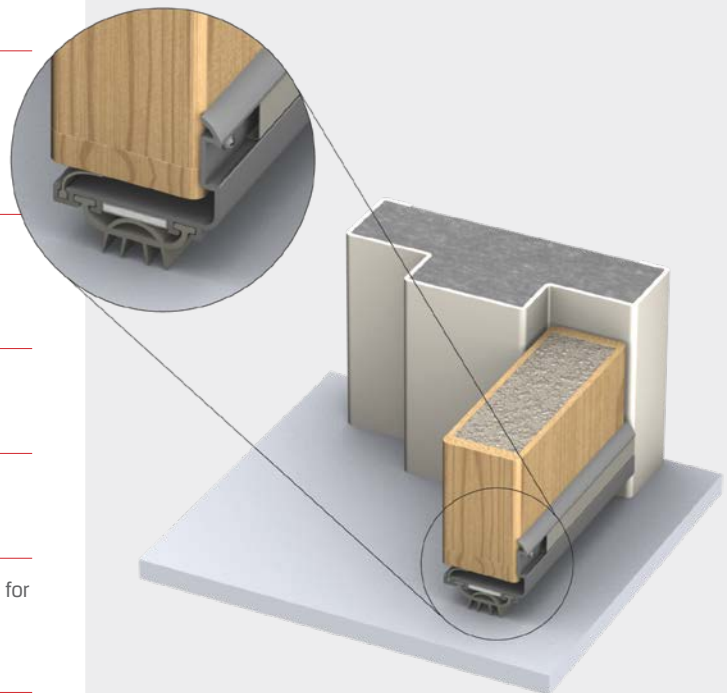

For more product information please scan QR code or visit www.kilargo.com.au/ourproducts/fdbu20/



All seals proudly manufactured in Australia

FDBU60



Used to upgrade existing fire doors where door bottom gaps exceed the allowable 10mm as per AS1905/1.

Key Features

- Can provide up to 2 hours fire resistance when fitted to the bottom of proprietary fire doors.
- Non compliant fire doors can be salvaged.
- Avoids expensive door build-ups or door replacements.
- Cost-effective solution.
- Easy retro-fit installation.
- No need to remove the door during installation.

Use With

Although not required for upgrade work, the Kilargo 4000 Series Threshold Plates may be incorporated as part of the overall system for both aesthetic and disability compliance issues.

Materials

These products consist of an anodised aluminium profile, flame retardant smoke, draught and light excluding silicone gasket and integral high performance intumescent fire seals.

Gap Size

- FDBU60-35 Can seal gaps up to 60mm maximum under nom. 35mm proprietary fire doors.
- FDBU60-45 Can seal gaps up to 60mm maximum under nom. 45mm proprietary fire doors.

Standard lengths

820mm, 920mm, 1220mm

Standard colours

Clear Anodised (Silver) with grey gaskets

Fixing

The FDBU60 is supplied with pre-drilled slotted holes and screws for easy application onto the bottom of door leaves. (Aluminium screw-fixed end plates are also available separately).

Approval/s

- Fully tested to AS1530 Part 4 for up to 2 hours on proprietary fire door assemblies in accordance with AS1905 Part 1
 - Conforms with BCA Specification C3.4 smoke sealing requirements
- NB: Check with your door manufacturer for approvals.

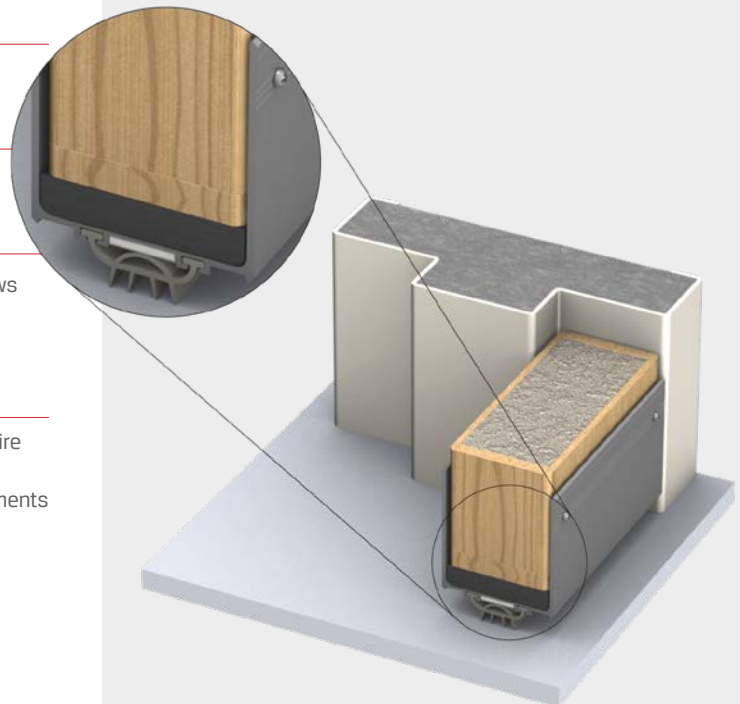
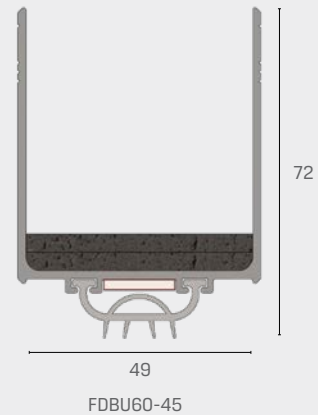
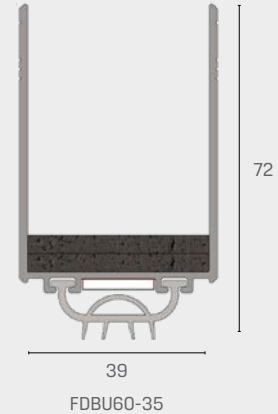

For more product information please scan QR code or visit www.kilargo.com.au/ourproducts/fdbu60/



All seals proudly manufactured in Australia

Retrofit Intumescent Fire Door Perimeter Upgrade Seal

KG4002



Intumescent retro-fit seal for upgrading door perimeter gaps where the clearance exceeds the maximum 3mm specified by AS1905/1. Used to upgrade existing fire doors with up to and including 6mm perimeter gaps.

Key Features

- Can provide up to 2 hours fire resistance on proprietary fire doors.
- Non compliant fire doors can be salvaged.
- Cost-effective solution.
- Easy retro-fit installation.
- Ideal for fire engineered solutions where extra protection is necessary for life safety.

Use With

Used in conjunction with a Kilargo Fire Door Bottom Upgrade seal FDBU20/60 to upgrade doors to comply with AS1905/1.

Materials

Consists of a flame retardant PVC top hat section, encapsulating a high performance intumescent material and two rows of aggressive self-adhesive tape.

Gap Size

Up to and including 6mm perimeter gaps.
(Dependent on fire door type. Please contact our Technical Department for relevant test approvals.)

Sizes

Dimensions: 38mm x 1.6mm

Standard colours

White, Silver
Can be painted on-site

Fixing

The KG4002 intumescent seal is simply applied to the top and sides of the door frame with two rows of aggressive self-adhesive tape. No screw fixing required.

Approval/s

- Fire tested to AS1530 Part 4 for up to 2 hours on proprietary fire doors in accordance with AS1905 Part 1

Note: Please check with our Technical Department or the Fire Door Manufacturer for relevant test approvals and suitability for door type.

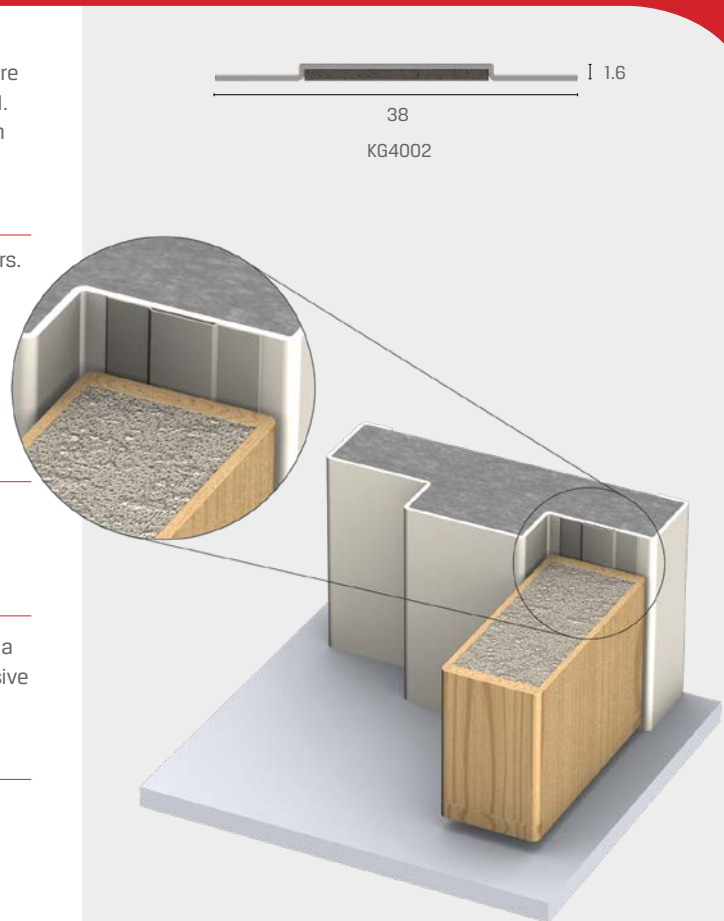

For more product information please scan QR code or visit www.kilargo.com.au/ourproducts/kg4002/



All seals proudly manufactured in Australia

KG5102



Low-profile intumescent perimeter seal set designed to upgrade existing proprietary fire doors. Allows for a cost-effective and clean build-up of non-rated steel frames with only 15mm stops, in lieu of the conventional 25mm stops required for fire doors.

Key Features

- Can provide up to 2 hours fire resistance on proprietary fire doors.
- Non compliant fire doors can be salvaged.
- Cost-effective solution.
- Easy retro-fit installation.
- Ideal for fire engineered solutions where extra protection is necessary for life safety.

Use With

Used in conjunction with a Kilargo Fire Door Bottom Upgrade seal FDBU20/60 to upgrade doors to comply with AS1905/1.

Materials

Consists of 2 x purpose-designed flame retardant PVC top hat sections, encapsulating intumescent material, with aggressive self-adhesive backing tape.

Gap Size

Nominal 2mm to 3mm perimeter gaps.

Sizes

Dimensions: 1 x (38mm x 1.6mm)
1 x (13mm x 1.6mm)

Standard colours

White, Grey
Can be painted on-site

Fixing

The KG5102 intumescent seal set is simply applied to the top and sides of the door frame with rows of aggressive self-adhesive tape. No screw fixing required.

Approval/s

- Fire tested to AS1530 Part 4 for up to 2 hours on proprietary fire doors in accordance with AS1905 Part 1

Note: Please check with our Technical Department or the Fire Door Manufacturer for relevant test approvals and suitability for door type.

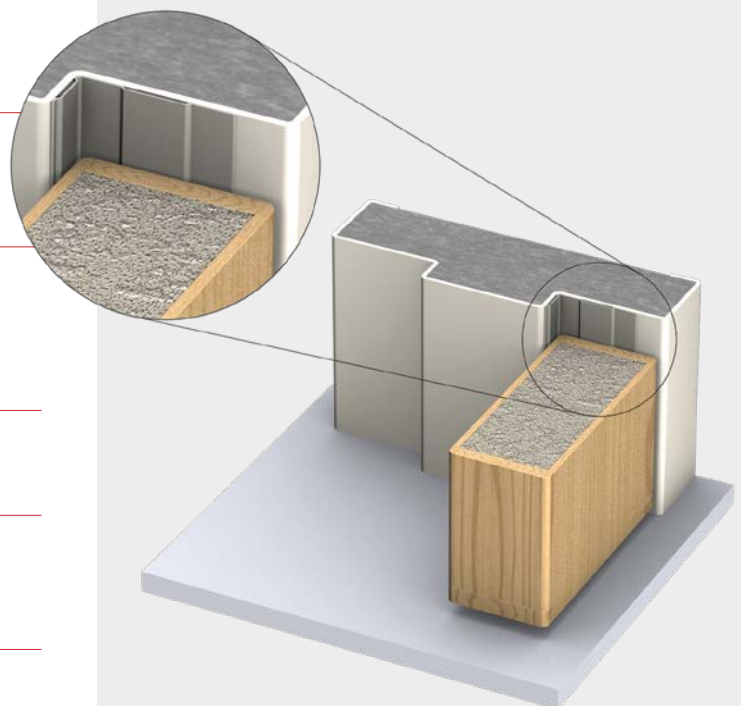
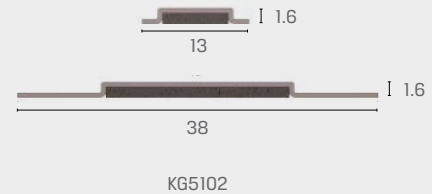

For more product information please scan QR code or visit www.kilargo.com.au/ourproducts/kg5102/



All seals proudly manufactured in Australia

IFD-D



The IFD-D series intumescent grilles have been fire tested in accordance to AS1530.4 for up to and including a 2 hour rating with most proprietary fire door assemblies, complying with AS1905.1.

The damper units are slimline with an overall thickness of only 35mm allowing them to be flush-fitted within conventional 37 and 47mm nominal fire door leaves. They are easily installed in new or existing fire doors and have no moving parts, resulting in a robust, trouble-free installation which will not rattle or vibrate during door operation.

The IFD-D intumescent fire damper kit comes complete with a pair of decorative face-fixed powder coated cover grilles that provide a clean, neat appearance, plus a tube of Kilargo fire-rated mastic.

Sizes

Standard door kit sizes:

- 300mm x 300mm
- 450mm x 450mm
- 600mm x 300mm
- 600mm x 600mm

Standard Colour

Powder-coated silver cover grilles.

Fixing

The IFD-D damper cell is centred into the prescribed door cut-out and held in place with Kilargo intumescent mastic. The decorative cover grilles are then secured to both sides of the door leaf with screws provided.

Approvals

- AS1530/4 fire tests with proprietary fire doors providing up to 2 hours fire resistance.
- Complies with AS1905/1

Note: Please check with our Technical Department or the Fire Door Manufacturer for relevant test approvals and suitability for door type.

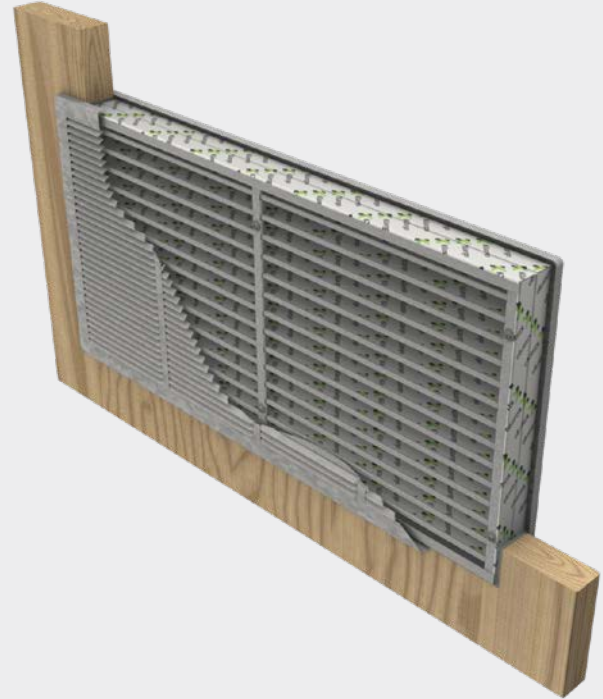

For more product information please scan QR code or visit www.kilargo.com.au/ourproducts/ifd-d/



All seals proudly manufactured in Australia

Location: Southbank Melbourne

Client: PDG & Schiavello

Architect: PDG & Schiavello in collaboration with Bates Smart

Builder: Brookfield Multiplex

Completion: 2015



Setting a new standard in urban living, the newly constructed Prima Tower offers a level of amenities not seen outside luxurious hotels.

Standing at 256m tall, Prima Tower is the second tallest residential tower in Melbourne, and the fifth tallest building in Australia.

Completed in early 2015, Prima Tower features 661 apartments, a private cinema, lap pool, gym and luxurious Sky Lounge. It's also home to the first virtual golf driving range in a residential building in the southern hemisphere.

Prima Tower has achieved a 7.1 star energy rating. A highlight of its sustainability and environmental features is a 60,000 capacity rainwater harvesting system and green feature walls with fully established plants.

With its elegant, streamlined curved bronze façade, the building has added distinctive appeal to the Melbourne skyline. Kilargo's world leading, smart sustainable products are an integral part of this exceptional project.

The simple and smart solution

This unique development incorporated elegant touches down to every detail – including Kilargo's discreetly stylish perimeter and door bottom seals. The unobtrusive design blended seamlessly with the interior of the Prima Tower, while meeting the necessary standards for fire, smoke and acoustics on apartment residence entry doors.

A combination of Kilargo's perimeter, door bottom and astragal seals were installed within the private cinema room to contain acoustics and create a completely immersive entertainment experience.

Kilargo worked closely with the developer to ensure all technical specifications were met and tested before installation – including providing product samples for mock-up rooms. This detailed approach to project management, the quality of our solutions, and our timely supply of Australian-made products combined with decades of experience helped achieve this world-class result.





HEALTHCARE & HYGIENIC ENVIRONMENTS

Door Sealing Solutions

-  Kilargo have been proudly involved in many new state-of-the-art hospitals now opened or being developed across the country.



Healthcare & Hygiene Sealing Systems Overview

We have provided sealing solutions for the Melbourne Royal Children's Hospital, Perth's Fiona Stanley Hospital, the Gold Coast University Hospital, plus the New Royal Adelaide Hospital – to name but a few.

Our simple and smart solutions maximise the health and well-being of staff, patients and visitors and the performance of these multiple occupancy, and often multi-storey, facilities.

Antimicrobial Solutions

The threat of bacterial infection exists in all environments, but particularly in 'high traffic' commercial buildings. Dangerous bacteria live on all common surfaces, including doors, door hardware and door seals. These can be easily spread by simple human contact.

To assist in suppressing the growth & spread of these bacteria, Kilargo has incorporated antimicrobial technology into the manufacture of its range of silicone door seals. Our innovative range of antimicrobial silicone gaskets provide outstanding performance with unbeatable hygiene, eliminating up to 99.99% of bacteria.

Manufactured with in-built SteriTouch® protection, these antimicrobial seals are designed for 'clean room' environments and buildings that demand superior infection control, including:

- hospitals, medical centres and nursing homes
- laboratories and testing facilities
- childcare centres and schools
- food-handling areas.

Like all Kilargo products, our SteriTouch® range is professionally manufactured to exacting standards – providing exceptional solutions for containing sound,

limiting the spread of smoke, improving energy efficiency and preventing weather infiltration. Along with incredible bacteria resistance, they're the perfect choice for the most hygienic buildings.

What is SteriTouch®?

SteriTouch® additives use the proven, natural sterilising properties of silver to reduce the growth of harmful bacteria, mould and fungi by up to 99.99%. In fact, SteriTouch® provides protection against a wide range of pathogens, and is particularly effective against illness-causing bacteria such as E.Coli, Salmonella and MRSA.

A trusted and established brand, SteriTouch® is safe for even the most sensitive applications and is backed by independent testing and continual assessment. In line with Kilargo's 'green' commitment, SteriTouch® additives do not leach and have no environmental impact.

Best of all, the antibacterial qualities of silver are constantly active and enduring – bringing the peace-of-mind and lasting protection you need.

Independent Testing Giving Valuable Reassurance

At Kilargo, we pride ourselves on using the best materials to deliver real confidence – especially when it comes to people's health and wellbeing.

All SteriTouch® additives are independently verified by leading antimicrobial test laboratories in the UK and Japan. Products are tested against E.Coli and MRSA, according to Internationally recognised Standards and with comprehensive test reports and resulting certification.



IS7010AMsi - IS8010AMsi

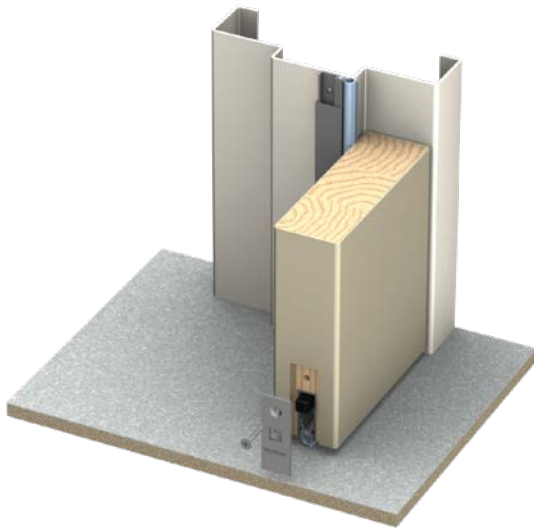

IS7020AMsi - IS8036AMsi

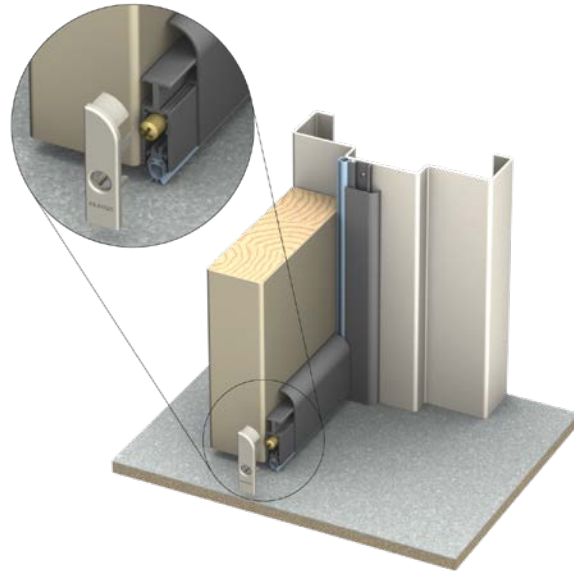

IS7195AMsi - IS8091AMsi

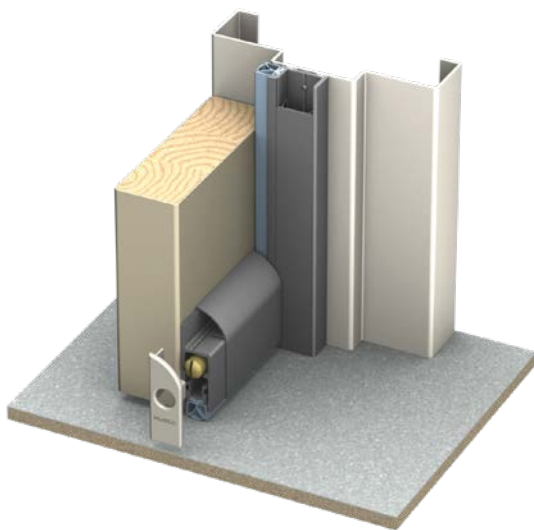

IS7085AMsi - IS7071AMsi - IS8020AMsi

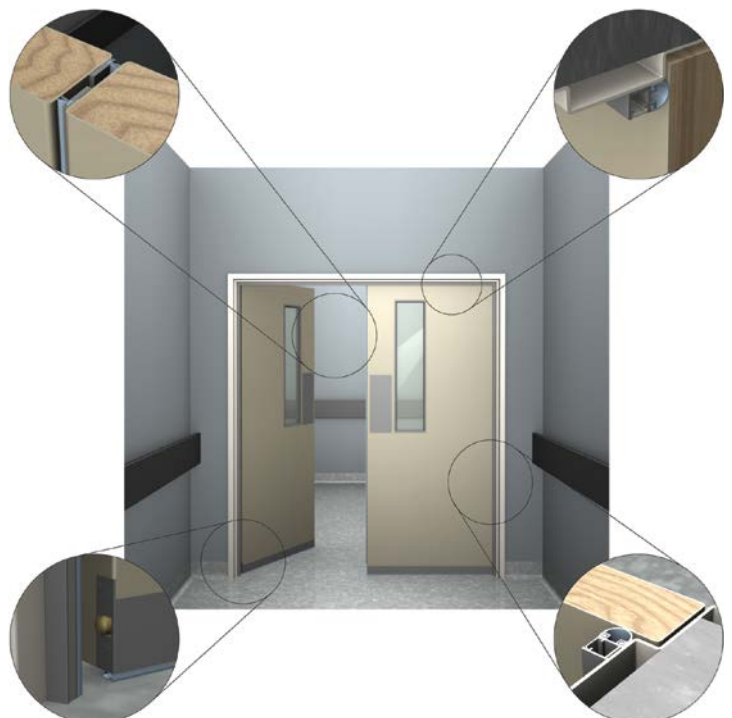



IS7020AMsi - IS7060AMsi - IS8090AMsi

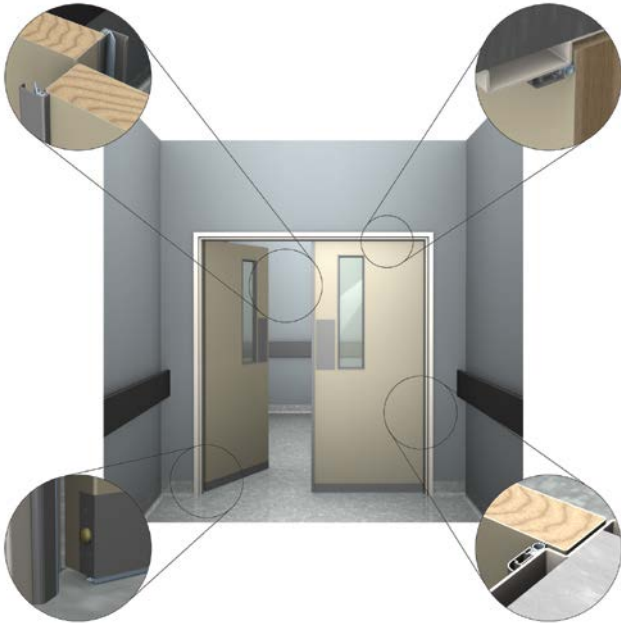

IS7071AMsi x2 - IS3022AMsi

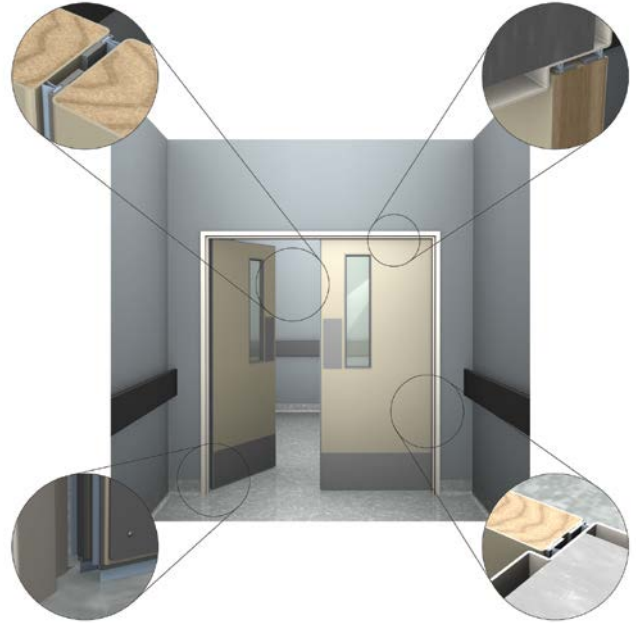

Note: This is a snapshot of recommended systems for our antimicrobial seal range. All Kilargo silicone (si) seals can be supplied in an antimicrobial version.

SOUND

Acoustic Door Sealing Solutions

 Wherever noise influences human activity, effective acoustic sealing is essential.



Acoustic Sealing Solutions Overview

The gaps around door assemblies are essential for effective operation – but they also allow sound to pass through. Sealing these gaps is crucial to reduce the amount of sound entering or leaving a room, providing effective noise insulation. Decreased sound disturbances can make an environment more appropriate and comfortable for its users, and will mean that separate spaces can continue with their activities without disturbance, as every space in a building is suited for particular purposes which require more or less sound insulation.

Kilargo offer a comprehensive range of acoustic sealing solutions for readily available standard architectural flush doors as well as proprietary fire door and acoustic door assemblies. When fitted to external doors, they help to isolate buildings from the noise generated by roads, railways and airports. When fitted to internal doors, they help isolate rooms from airborne noise generated within a building, making them ideal for auditoriums, offices and conference rooms, educational establishments, hotel rooms and individual apartments in multi-occupancy buildings.

Acoustic Standards & Test Methods

A series of comprehensive test programs to establish airborne sound insulation performance of Kilargo acoustic seals have been carried out at the Royal Melbourne Institute of Technology (RMIT) acoustic laboratory, plus Resolute's Acoustic Testing Laboratory in Australia.

The relevant standards used for conducting testing are:

AS1191:2002 – Acoustics – Method for laboratory measurement of airborne sound insulation of building elements

ISO 10140 – Acoustics – Laboratory measurements of sound insulation of building elements - part 1, 2, 4 and 5, which in 2010 superseded **ISO 140-3:1995 – Acoustics – Methods of measurements of sound insulation in buildings & of building elements. Part 3 – Laboratory measurements of airborne sound insulation of building elements.**

The results obtained from the testing are used to determine the acoustic rating in accordance with:

AS/NZS ISO 717.1:2004 – Acoustics – Rating of sound insulation in buildings and of building elements. Part 1 – Airborne Sound Insulation, which in 2004 superseded **AS1276-1:1999 – Acoustics – Rating of sound insulation in buildings and of building elements. Part 1 – Airborne Sound Insulation.** **AS/NZS ISO 717.1:2004** is identical to **ISO 717-1:1996 – Acoustics – Rating of sound insulation in buildings and of building elements. Part 1 – Airborne Sound Insulation.**

Building Code of Australia (BCA)

Building regulations exist to ensure the safety and comfort of people entering or using a building.

The BCA has the objective of safeguarding occupants in residential buildings from loss of amenity resulting from excessive noise; including:

- noise transmitted between adjoining dwelling or units containing sleeping facilities;
- noise transmitted from common spaces into adjoining units; and
- noise transmitted from parts of the building with a different classification into adjoining units.

The BCA sets out specific sound insulation acoustic performance requirements for door assemblies to meet this objective. The sound insulation provisions are found in Part F5 of Volume One and Parts 2.4 & 3.8.6 of Volume Two. These provisions relate to the following Building classes:

Volume One, Part F5

- Class 2 buildings: apartment buildings & multi-residential
- Class 3 buildings: hotels, motels & boarding houses
- Class 9c buildings: aged care facilities

Volume Two, Parts 2.4 & 3.8.6

- Class 1 building: single dwelling or multi-attached dwellings separated by a fire resisting wall

In Volume One of the BCA, Section F5.5 requires a door assembly in a Class 2 or Class 3 building that separates a sole-occupancy unit from a stairway, public corridor, public lobby or the like – **to have a minimum sound insulation rating of Rw30.**

Acoustic Testing

Under test conditions, door assemblies are tested with standard operational clearances in the following three conditions.

- Un-caulked – with no seals present around the door perimeter & threshold.
- Fully-caulked – all perimeter and threshold gaps are completely sealed with a high density putty to determine the maximum possible acoustic performance of the door assembly.
- Un-caulked but with Kilargo seals fitted to the perimeter & threshold gaps.

By comparing the results obtained in the three conditions, it is possible to determine the sound insulation contribution achieved by fitting Kilargo seals to a door assembly.

In many cases, the weakest point of a door system is in fact the acoustic performance of the door leaf itself. This is highlighted when a sealing system performance equals the performance of the fully caulked door.

For higher acoustic ratings a proprietary acoustic door panel construction is necessary. Kilargo conducts testing in partnership with major acoustic door manufacturers and we can assist in finding a door solution for your specific requirement.

Expression of Results

Acoustic measurements are performed in accordance with the measurement procedures of AS1191 and ISO 10140. Those standards describe methods for measuring the airborne sound insulation of building elements.

The acoustic testing process involves installing a representative door construction (specimen) within a dividing wall (specimen holder), between the sound Source room and the Receiving room. Sound waves across a wide range of frequencies are produced in the source room via a loudspeaker. Microphones record an average of the sound pressure levels in each room in the frequency range of 100Hz – 5000Hz. The difference between the sound pressure levels recorded in each room is determined as the Sound Reduction Index (R), calculated in accordance with AS/NZS ISO 717.1. These measurements are then processed at one-third octave intervals between 100Hz and 3150Hz to obtain the Weighted Sound Reduction Index (Rw).

Solid Core Doors



Although solid core doors generally do not have to meet any fire performance requirements, they must still provide the relevant acoustic rating as stipulated in the current National Construction Code, to provide amenity in Class 2, 3 & 9c buildings (not less than 30Rw).

Kilargo seals have been extensively tested to not only ensure effective acoustic attenuation, but also to provide minimal resistance to opening and closing of doors in everyday service.

The following Kilargo sealing combinations achieved a minimum 30Rw sound insulation rating, as tested on standard commercially available 35mm, 40mm & 45mm solid core door assemblies.

Contact Kilargo for additional acoustic sealing systems approved for solid core doors.

REF 1 IS1212 - IS8011si

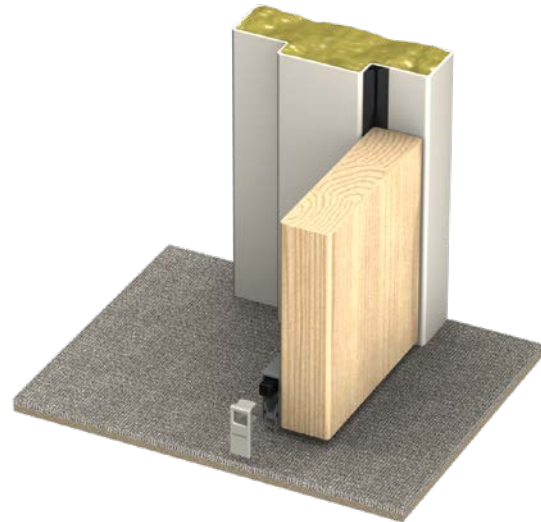

Door Thickness	Rw	STC
35mm	30	30
40mm	32	32

REF 2 IS1212 - IS8010si

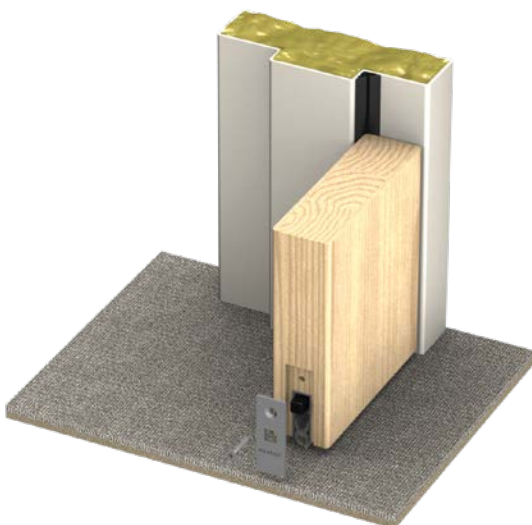

Door Thickness	Rw	STC
40mm	31	31
45mm	31	31

REF 3 IS7025si - IS8010si

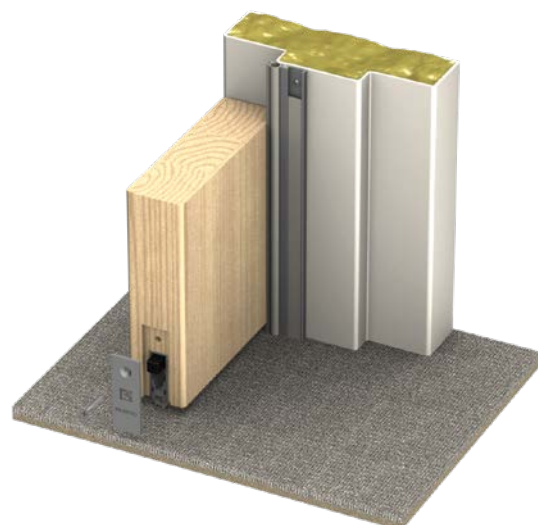

Door Thickness	Rw	STC
40mm	30	31
45mm	31	31

Solid Core Doors



REF IS7025si - IS8011si
4

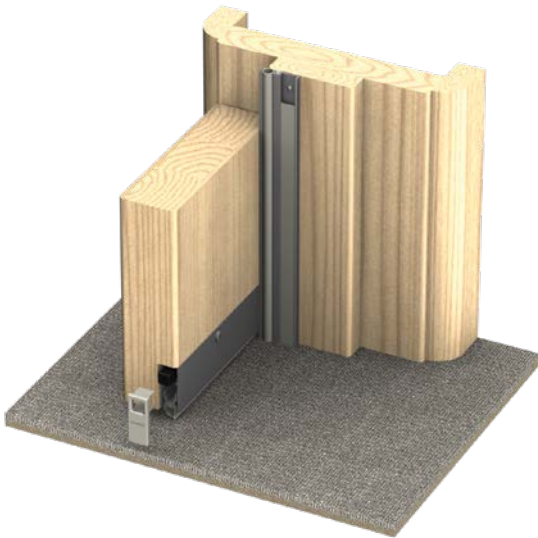

Door Thickness	Rw	STC
40mm	32	32

REF IS7080si - IS8010si
5



Door Thickness	Rw	STC
40mm	30	31
45mm	31	31

REF IS7080si - IS8090si
6

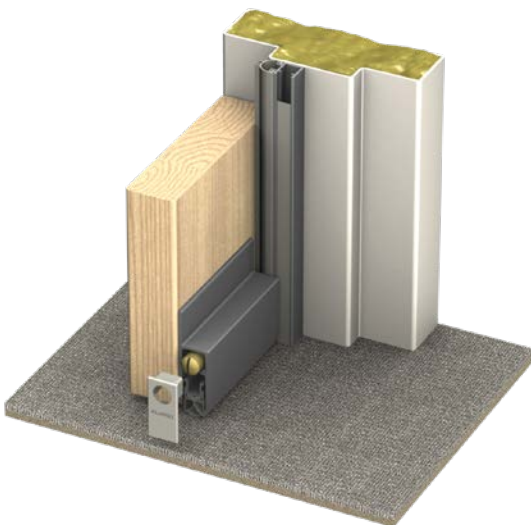

Door Thickness	Rw	STC
35mm	30	30
40mm	32	32

REF IS7010si - IS8010si
7

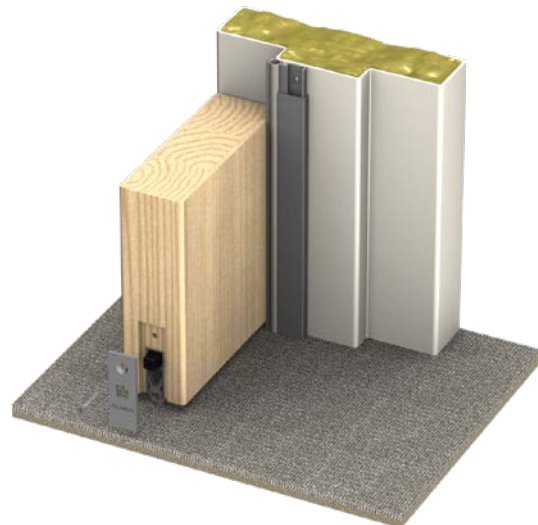

Door Thickness	Rw	STC
45mm	31	31

Acoustic Sealing Solutions

Solid Core Doors 🔊

REF IS7020si - IS8010si
8



Door Thickness	Rw	STC
45mm	31	31

REF IS7080si - IS8020si
9

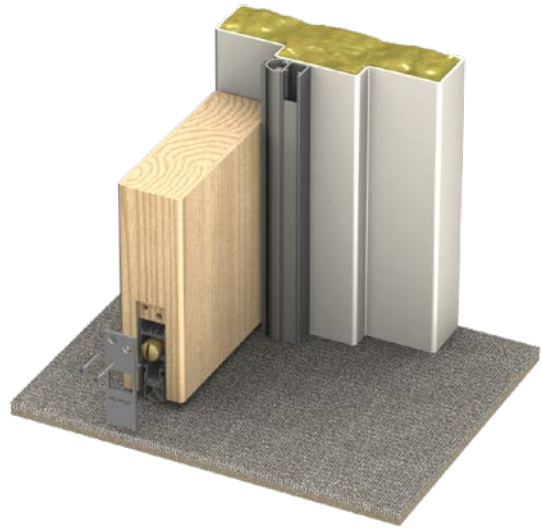

Door Thickness	Rw	STC
45mm	31	31

REF IS7087si - IS8090si
10



Door Thickness	Rw	STC
45mm	32	32

REF IS7195si - IS8090si
11

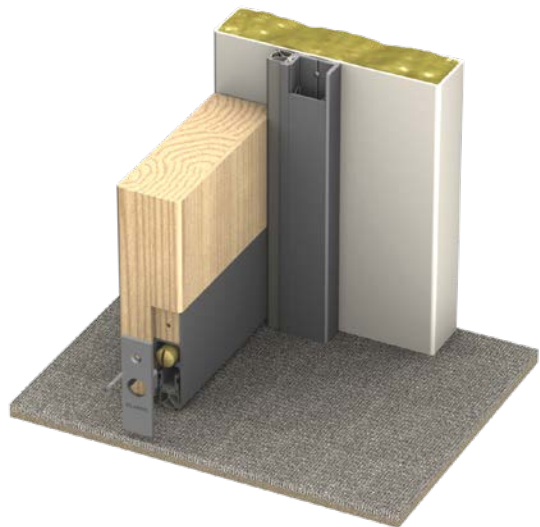

Door Thickness	Rw	STC
45mm	32	32

Acoustic Sealing Solutions

Solid Core Doors



REF 12 IS7010si - IS4226si

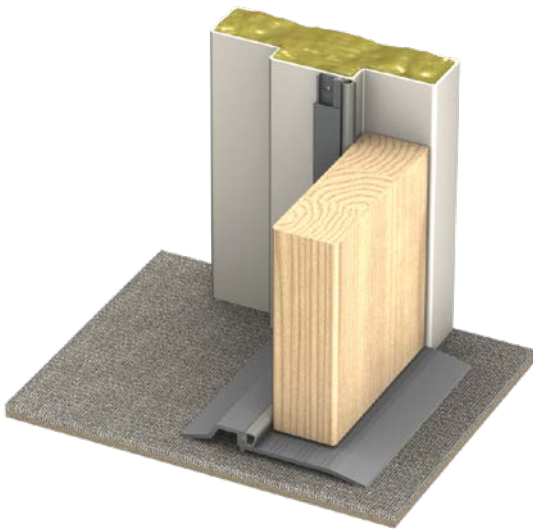

Door Thickness	Rw	STC
45mm	32	32

REF 13 IS7190si - IS8090si

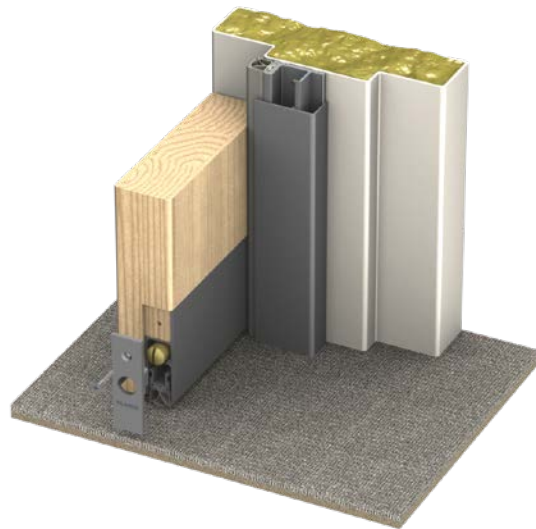

Door Thickness	Rw	STC
40mm	30	31

REF 14 IS1212 - IS7061 - IS8011si

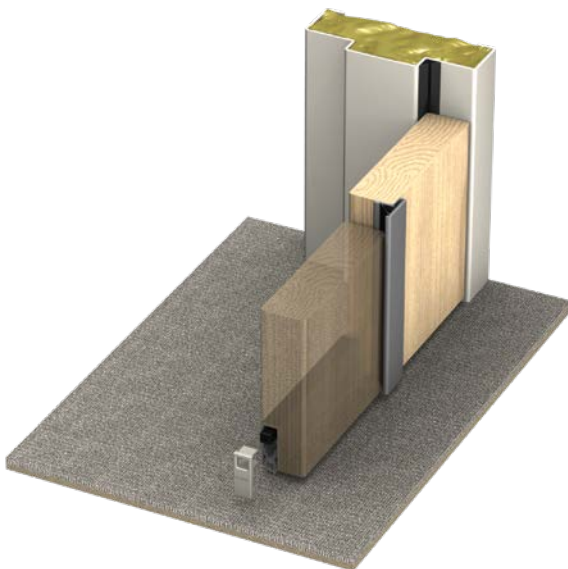

Door Thickness	Rw	STC
35mm	30	30
40mm	31	31

REF 15 IS7025si - IS7071si x 2 - IS8090si

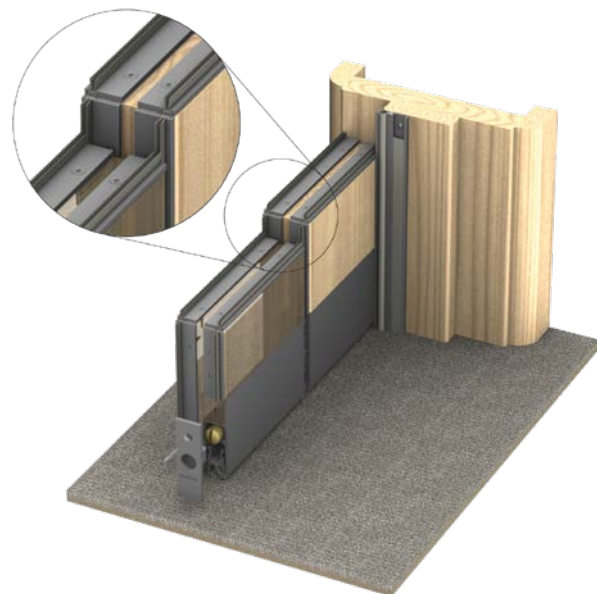

Door Thickness	Rw	STC
35mm	30	30
40mm	31	31

Solid Core Doors 🔊

REF IS1212 - IS8011si
16 Interconnecting Doors

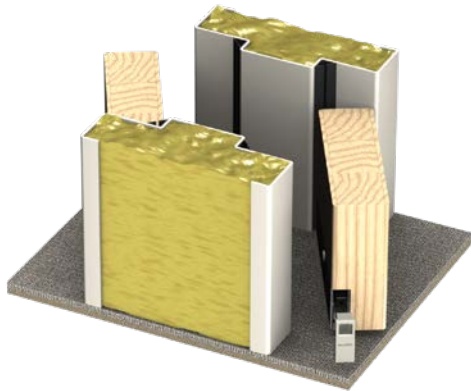

Door Thickness	Rw	STC
35mm	42	42
40mm	45	45

REF IS7025si - IS7061 - IS8090si
17 Interconnecting Door Pairs

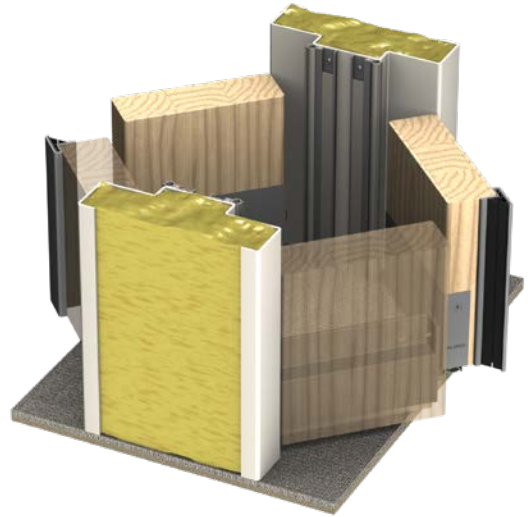

Door Thickness	Rw	STC
35mm	42	42
40mm	45	46

REF IS7020si - IS7060si x 2 - IS8010si
18

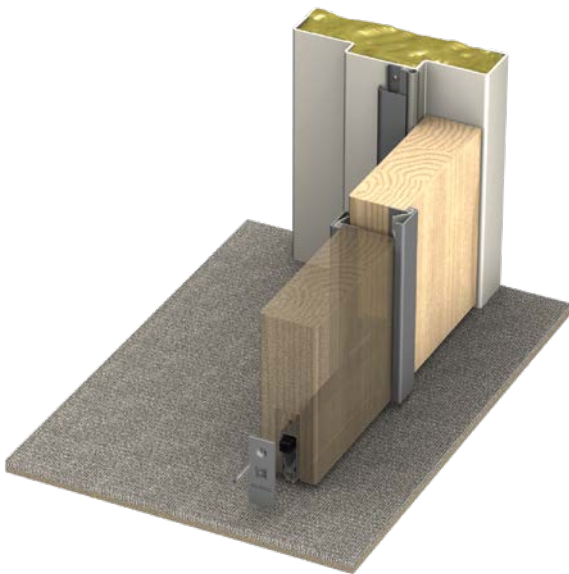

Door Thickness	Rw	STC
45mm	31	31

REF IS7080si - IS7060si x 2 - IS8090si
19

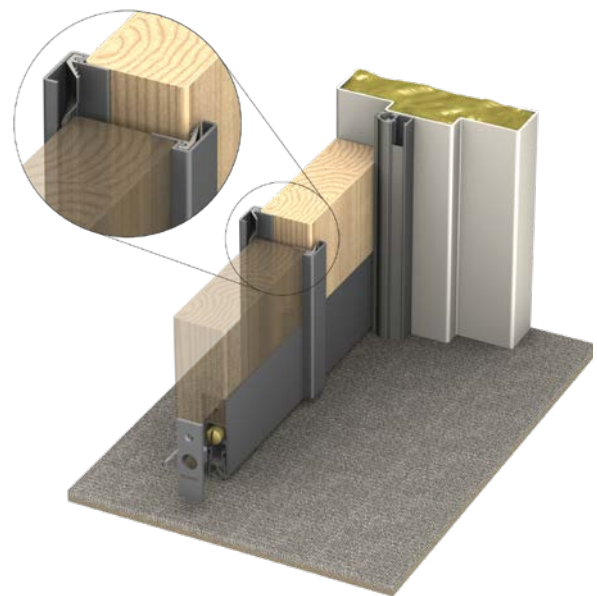

Door Thickness	Rw	STC
45mm	31	31

Acoustic Sealing Solutions

Solid Core Doors / Glazed Aluminium Doors



REF IS7087si - IS7071si x 2 - IS8020si
20

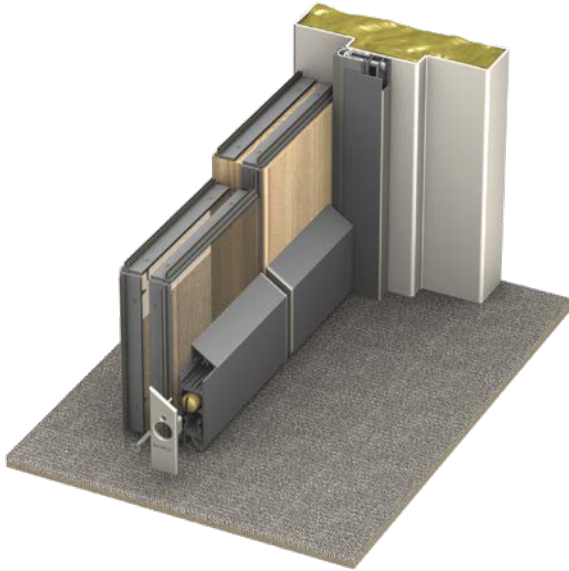

Door Thickness	Rw	STC
45mm	31	31

REF IS7080si - IS8020si - IS4015
21 (Black Anodised shown)

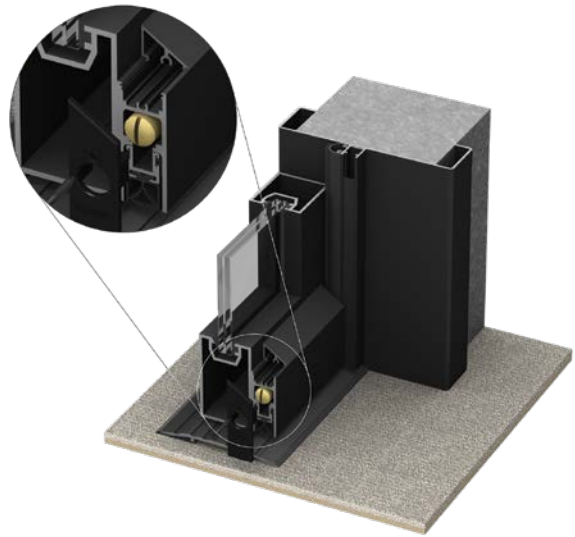

Door Thickness	Rw	STC
45mm	35	34

* system incorporates nom. 10mm laminate glass

REF IS7071si x 2 - IS5111si - IS4015
22

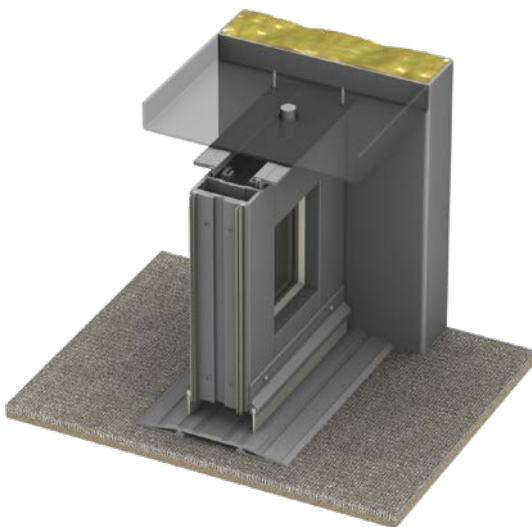

Door Thickness	Rw	STC
45mm	33	33

* system incorporates nom. 10mm laminate glass

REF IS7071si x2 - IS5111si - IS4015
23

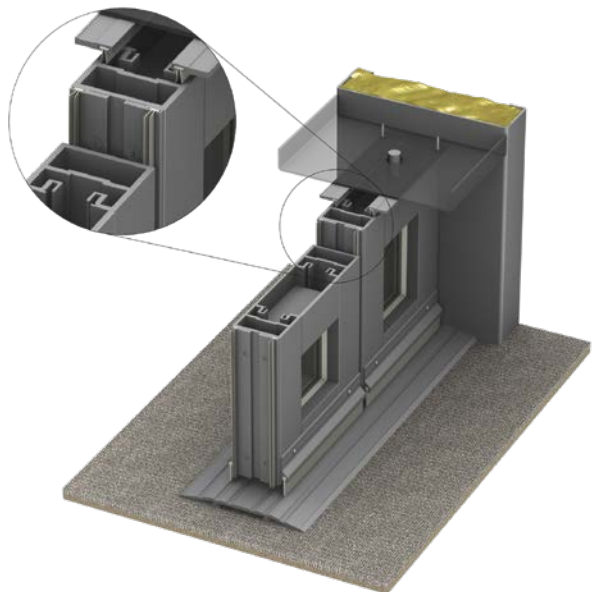

Door Thickness	Rw	STC
45mm	34	33

* system incorporates nom. 10mm laminate glass

Solid Core Door Systems Test Performance Data



Test Ref	Sealing System	Rw	STC	Frequency (Hz) / STL (dB)																
				100	125	160	200	250	315	400	500	630	800	1000	1250	1600	2000	2500	3150	4000
Single 35mm Solid Core Doors																				
	Fully caulked	30	31	20.0	24.0	22.0	26.0	23.0	25.0	24.0	24.0	26.0	27.0	30.0	32.0	35.0	37.0	40.0	43.0	44.0
1	IS1212 - IS8011si	30	30	19.0	24.0	22.0	26.0	23.0	25.0	24.0	24.0	26.0	27.0	29.0	31.0	34.0	35.0	37.0	38.0	40.0
6	IS7080si - IS8090si	30	30	19.0	23.0	21.0	26.0	23.0	25.0	24.0	24.0	26.0	26.0	29.0	32.0	35.0	37.0	40.0	39.0	43.0
	IS1515 - IS8090si	30	30	19.0	24.0	22.0	26.0	23.0	25.0	24.0	24.0	26.0	27.0	29.0	31.0	34.0	35.0	37.0	38.0	40.0
	IS1515 - IS8020si	30	30	19.0	24.0	22.0	26.0	23.0	25.0	24.0	24.0	26.0	27.0	29.0	31.0	34.0	35.0	37.0	38.0	40.0
Single 40mm Solid Core Doors																				
	Fully caulked	32	33	22.0	24.0	28.0	30.0	27.0	26.0	28.0	27.0	27.0	28.0	31.0	34.0	37.0	38.0	41.0	43.0	44.0
2	IS1212 - IS8010si	31	31	22.0	24.0	27.0	30.0	27.0	26.0	28.0	27.0	27.0	28.0	32.0	34.0	35.0	36.0	39.0	41.0	41.0
1	IS1212 - IS8011si	32	32	21.0	26.0	29.0	31.0	31.0	31.0	32.0	31.0	29.0	27.0	28.0	31.0	34.0	35.0	36.0	39.0	40.0
3	IS7025si - IS8010si	30	31	21.0	24.0	27.0	30.0	27.0	26.0	28.0	27.0	27.0	28.0	30.0	32.0	35.0	37.0	40.0	40.0	41.0
4	IS7025si - IS8011si	32	32	21.0	28.0	28.0	32.0	33.0	33.0	33.0	33.0	31.0	28.0	27.0	30.0	32.0	34.0	37.0	40.0	41.0
5	IS7080si - IS8010si	30	31	22.0	24.0	27.0	30.0	27.0	26.0	28.0	27.0	27.0	27.0	28.0	29.0	33.0	35.0	37.0	39.0	38.0
6	IS7080si - IS8090si	32	32	21.0	23.0	25.0	29.0	27.0	26.0	28.0	27.0	27.0	27.0	29.0	34.0	36.0	38.0	41.0	42.0	44.0
	IS7090si - IS8090si	30	31	20.0	24.0	27.0	30.0	27.0	26.0	28.0	27.0	27.0	27.0	28.0	30.0	32.0	35.0	38.0	39.0	35.0
13	IS7190si - IS8090si	30	31	20.0	24.0	27.0	30.0	27.0	26.0	28.0	27.0	27.0	27.0	28.0	30.0	32.0	35.0	38.0	39.0	35.0
	IS7090si - IS8100si	30	30	19.0	24.0	27.0	30.0	27.0	26.0	28.0	27.0	27.0	27.0	28.0	30.0	32.0	35.0	38.0	39.0	35.0
	IS7190si - IS8100si	30	30	19.0	24.0	27.0	30.0	27.0	26.0	28.0	27.0	27.0	27.0	28.0	30.0	32.0	35.0	38.0	39.0	35.0
Single 45mm Solid Core Doors																				
	Fully caulked	33	33	29.6	28.3	30.3	32.3	32.3	31.1	30.5	29.6	29.3	29.3	31.1	33.2	35.2	37.6	39.3	40.7	42.1
2	IS1212 - IS8010si	31	31	30.1	26.5	30.6	33.8	34.3	32.7	32.5	32.9	31.8	28.5	26.9	30.3	32.1	33.7	33.8	32.4	34.2
7	IS7010si - IS8010si	31	31	29.9	27.0	30.1	34.5	34.6	32.9	33.1	33.0	32.5	28.4	26.8	29.3	30.1	33.0	34.0	33.5	35.0
8	IS7020si - IS8010si	31	31	29.7	26.6	30.2	33.6	34.0	33.2	32.9	33.4	32.3	28.6	27.2	29.2	30.2	33.2	34.0	33.3	35.0
3	IS7025si - IS8010si	31	31	29.4	26.0	30.6	33.9	34.0	32.7	33.0	33.3	32.3	29.0	27.0	29.3	30.1	33.0	34.1	33.5	35.0
5	IS7080si - IS8010si	31	31	29.7	27.1	30.3	34.0	34.7	33.9	33.6	33.1	29.8	28.1	27.6	29.1	30.0	32.8	33.4	32.9	34.4
9	IS7080si - IS8020si	31	31	29.5	27.3	29.9	33.5	34.4	33.5	33.1	32.2	29.6	28.1	27.5	28.8	30.0	32.5	34.0	34.9	36.3
	IS7085si - IS8020si	31	31	29.8	26.8	29.2	33.1	34.2	32.5	32.9	32.0	31.2	29.0	27.6	29.2	30.0	31.8	33.2	34.4	37.0
10	IS7087si - IS8090si	32	32	30.3	26.6	29.6	32.1	32.5	30.9	30.8	30.4	29.9	29.2	28.4	31.4	31.3	33.7	35.8	38.1	39.5
	IS7095si - IS8090si	32	33	32.7	27.0	29.9	33.2	34.1	32.2	31.7	32.7	31.8	29.8	28.6	30.9	30.7	32.5	35.4	38.5	39.5
11	IS7195si - IS8090si	32	32	33.0	27.0	30.5	33.2	33.1	31.3	31.4	30.9	31.1	29.8	28.0	29.3	29.8	33.2	35.9	38.2	39.1
12	IS7010si - IS4226si	32	32	29.7	26.5	30.3	34.0	34.2	32.7	32.8	32.3	31.1	28.7	27.8	29.8	30.8	33.2	35.7	38.3	39.4
35mm Solid Core Door Pairs																				
	Fully caulked	30	31	20.0	24.0	22.0	26.0	23.0	25.0	24.0	24.0	26.0	27.0	30.0	32.0	35.0	37.0	40.0	41.0	43.0
14	IS1212 - IS7061 - IS8011si	30	30	20.0	24.0	22.0	26.0	23.0	25.0	24.0	24.0	26.0	27.0	29.0	31.0	33.0	35.0	36.0	37.0	39.0
	IS1212 - IS7071si - IS8011si	30	30	19.0	24.0	22.0	25.0	23.0	24.0	24.0	24.0	26.0	27.0	29.0	31.0	33.0	35.0	36.0	35.0	36.0
	IS7025si - IS7061 - IS8090si	30	30	20.0	24.0	22.0	26.0	23.0	25.0	24.0	24.0	26.0	27.0	30.0	32.0	34.0	35.0	37.0	37.0	39.0
15	IS7025si - IS7071si x2 - IS8090si	30	30	19.0	24.0	22.0	25.0	23.0	25.0	24.0	24.0	26.0	27.0	30.0	32.0	34.0	35.0	37.0	35.0	36.0
Interconnecting 35mm Solid Core Doors																				
16	IS1212 - IS8011si	42	42	22.0	28.0	27.0	33.0	31.0	34.0	35.0	36.0	40.0	43.0	48.0	51.0	55.0	59.0	61.0	64.0	66.0
	IS7025si - IS8090si	42	42	21.0	28.0	27.0	33.0	31.0	34.0	35.0	36.0	40.0	43.0	49.0	52.0	55.0	53.0	56.0	57.0	58.0
Interconnecting 35mm Solid Core Door (Pairs)																				
	IS1212 - IS7061 - IS8011si	42	42	22.0	28.0	27.0	33.0	31.0	34.0	35.0	36.0	40.0	43.0	48.0	51.0	55.0	59.0	61.0	64.0	66.0
	IS1212 - IS7071si - IS8011si	42	42	21.0	28.0	27.0	33.0	31.0	34.0	35.0	36.0	40.0	43.0	48.0	51.0	55.0	59.0	61.0	60.0	61.0
17	IS7025si - IS7061 - IS8090si	42	42	22.0	28.0	27.0	33.0	31.0	34.0	35.0	36.0	40.0	43.0	49.0	53.0	57.0	60.0	63.0	64.0	67.0
	IS7025si - IS7071si - IS8090si	42	42	21.0	28.0	27.0	33.0	31.0	34.0	35.0	36.0	40.0	43.0	49.0	52.0	55.0	53.0	56.0	57.0	58.0
40mm Solid Core Doors Pairs																				
	Fully caulked	32	33	22.0	24.0	28.0	30.0	27.0	26.0	28.0	27.0	27.0	28.0	31.0	34.0	37.0	38.0	41.0	43.0	44.0
14	IS1212 - IS7061 - IS8011si	31	31	21.0	24.0	24.0	27.0	26.0	24.0	27.0	27.0	27.0	28.0	30.0	34.0	35.0	36.0	35.0	34.0	34.0
	IS1212 - IS7071si - IS8011si	31	31	21.0	24.0	26.0	28.0	27.0	25.0	28.0	27.0	27.0	28.0	29.0	32.0	34.0	36.0	36.0	36.0	38.0
	IS7025si - IS7061 - IS8090si	31	31	22.0	24.0	26.0	29.0	27.0	25.0	28.0	27.0	27.0	28.0	29.0	33.0	34.0	36.0	38.0	39.0	39.0
15	IS7025si - IS7071si x2 - IS8090si	31	31	21.0	24.0	26.0	28.0	27.0	25.0	28.0	27.0	27.0	28.0	29.0	33.0	34.0	36.0	38.0	36.0	37.0
Interconnecting 40mm Solid Core Doors																				
16	IS1212 - IS8011si	45	45	23.0	28.0	31.0	35.0	35.0	33.0	39.0	40.0	42.0	45.0	50.0	57.0	58.0	60.0	60.0	57.0	58.0
	IS7025si - IS8090si	45	46	23.0	23.0	33.0	37.0	36.0	36.0	40.0	40.0	41.0	44.0	49.0	54.0	57.0	61.0	64.0	61.0	63.0
Interconnecting 40mm Solid Core Door (Pairs)																				
	IS1212 - IS7061 - IS8011si	45	45	23.0	28.0	31.0	35.0	35.0	33.0	39.0	40.0	42.0	45.0	50.0	57.0	58.0	60.0	60.0	57.0	58.0
	IS1212 - IS7071si - IS8011si	45	45	23.0	28.0	33.0	37.0	36.0	35.0	40.0	40.0	42.0	44.0	48.0	54.0	57.0	60.0	62.0	61.0	62.0
17	IS7025si - IS7061 - IS8090si	45	46	24.0	28.0	33.0	38.0	36.0	36.0	40.0	40.0	42.0	45.0	49.0	56.0	56.0	52.0	56.0	57.0	64.0
	IS7025si - IS7071si - IS8090si	45	46	23.0	28.0	33.0	37.0	36.0	36.0	40.0	40.0	41.0	44.0	49.0	54.0	57.0	61.0	64.0	61.0	63.0
45mm Solid Core Doors Pairs																				
	Fully caulked	33	34	30.2	28.8	30.7	31.4	32.5	32.1	32.8	30.8	31.0	28.3	30.1	32.4	34.6	36.5	38.9	40.4	42.1
18	IS7020si - IS7060si x2 - IS8010si	31	31	26.3	26.4	29.4	29.2	32.1	31.6	32.3	31.4	31.3	29.0	28.5	29.4	31.2	32.8	32.6	32.9	33.8
	IS7020si - IS7071si - IS8010si	31	31	25.3	26.0	28.8	29.3	32.1	31.1	31.4	31.0	30.6	28.5	28.3	28.9	30.0	31.6	33.9	36.3	37.3
19	IS7080si - IS7060si x2 - IS8090si	31	31	25.3	25.3	28.9														

Proprietary Fire Rated Doors



Traditionally, a fire resistant door assembly was required to demonstrate its capacity for resisting the passage of hot smoke and gases under the conditions of a strictly controlled test in accordance with local building regulations and Standards. In Australia, a fire resistant door assembly must be tested in accordance with AS1530 Part 4, to meet the requirements of AS1905 Part 1.

Today's demands on fire doors go well beyond such requirements. Depending on its location in a building, the fire door assembly may also require a designated standard of acoustical performance. Such doorsets play a major role in modern life safety specifications for public, commercial and multi-occupancy buildings.

Kilargo offers a comprehensive suite of approved solutions for both 1 hour and 2 hour proprietary fire door assemblies, all achieving a minimum sound insulation rating of 30Rw.

REF 24 IS1212 - IS8010si

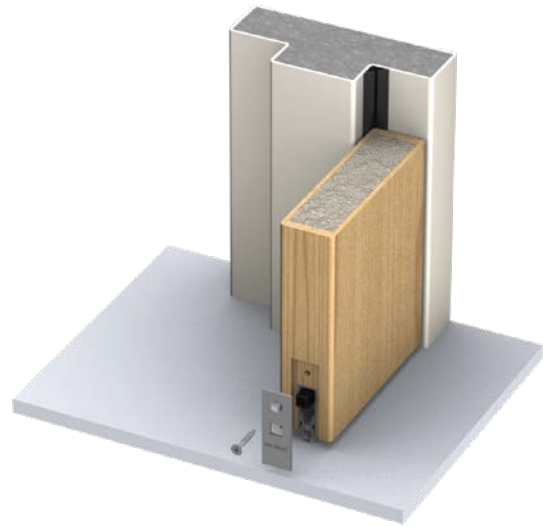

Door Thickness	Rw	STC
37mm	30	30
47mm	30	31

REF 25 IS1212 - IS8011si

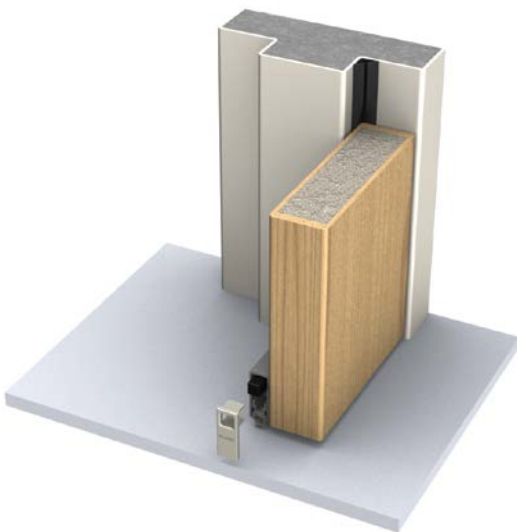

Door Thickness	Rw	STC
37mm	30	30
47mm	31	31

REF 26 IS7025si - IS5111si

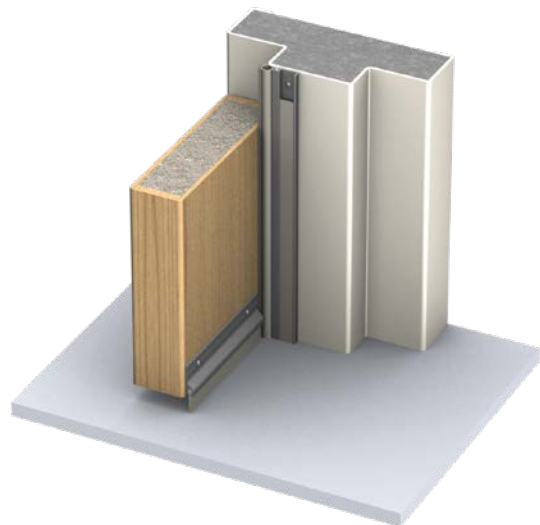

Door Thickness	Rw	STC
37mm	30	30

Acoustic Sealing Solutions

Proprietary Fire Rated Doors



REF **IS7025si - IS8010si**
27

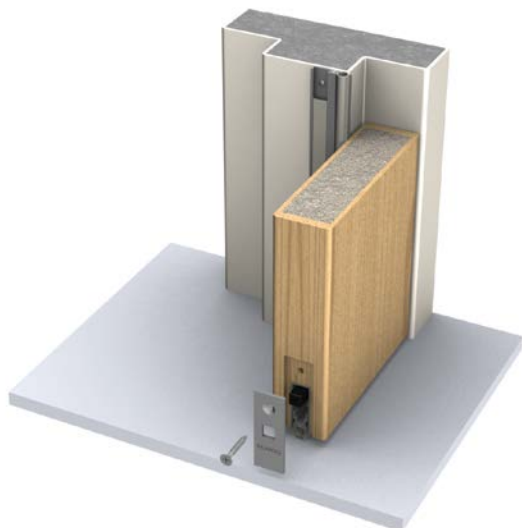

Door Thickness	Rw	STC
37mm	30	30
47mm	31	31

REF **IS7080si - IS8020si**
28

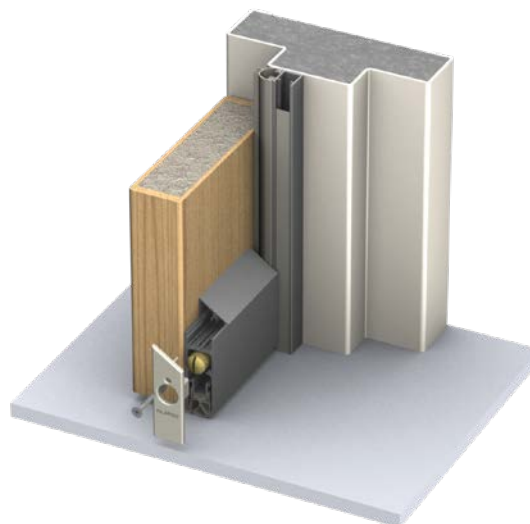

Door Thickness	Rw	STC
37mm	31	31

REF **KG1612BW - IS8035si**
29

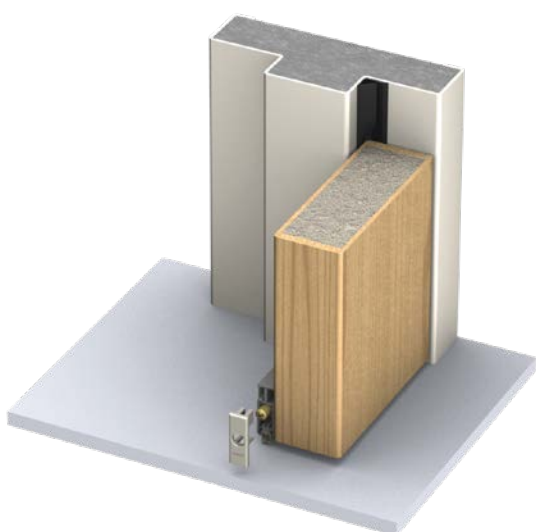

Door Thickness	Rw	STC
47mm	30	30

REF **IS7080si - IS8090si**
30

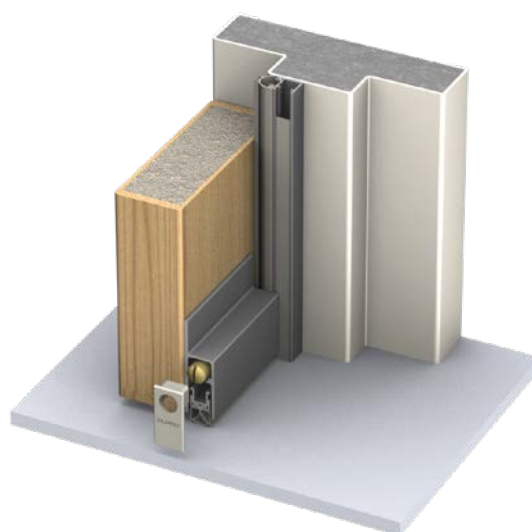

Door Thickness	Rw	STC
47mm	31	31

Proprietary Fire Rated Doors



REF IS7195si - IS8090si
31

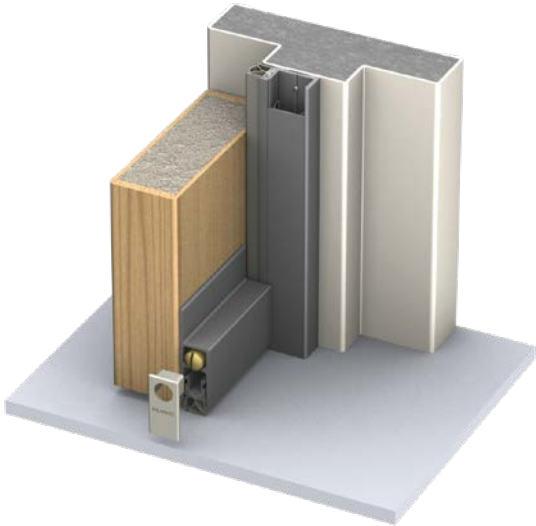

Door Thickness	Rw	STC
47mm	30	30

REF IS1212 - FDMS-TP - IS8010si
32

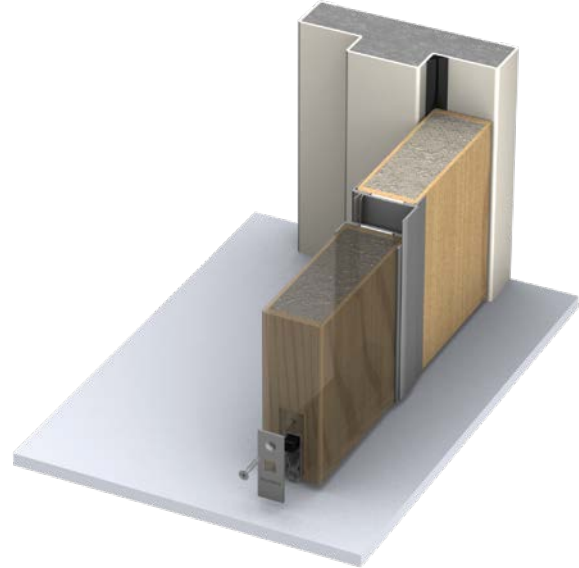

Door Thickness	Rw	STC
47mm	31	31

REF KG1612BW - FDMS-TP - IS8010si
33

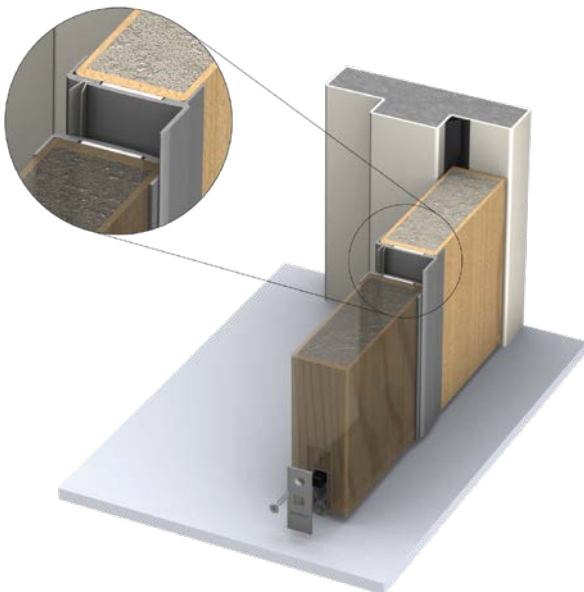

Door Thickness	Rw	STC
47mm	30	30

Proprietary Fire Door Systems Test Performance Data



Test Ref	Sealing System	Rw	STC	Frequency (Hz) / STL (dB)																	
				100	125	160	200	250	315	400	500	630	800	1000	1250	1600	2000	2500	3150	4000	5000
Single Proprietary Fire Door - nom. 37mm thick																					
	Fully caulked	31	31	23.5	21.3	24.3	23.9	25.9	27.1	28.3	27.8	27.0	26.5	28.1	30.5	33.7	36.1	37.8	39.3	40.6	42.1
24	IS1212 - IS8010si	30	30	25.4	23.5	24.3	25.0	25.5	26.7	28.7	29.6	28.9	25.2	24.6	27.4	30.4	32.2	33.2	34.1	35.7	37.1
25	IS1212 - IS8011si	30	30	25.3	23.2	24.7	25.3	26.2	27.3	28.9	29.1	28.8	26.2	25.3	28.2	30.6	32.4	32.9	33.5	34.7	35.4
	IS1212 - IS8090si	30	30	26.2	23.5	24.1	24.9	26.1	27.0	28.9	29.0	29.2	26.6	25.6	27.9	30.1	31.6	31.9	32.6	33.9	34.8
26	IS7025si - IS5111si	30	30	24.0	23.7	25.2	31.7	28.1	28.1	30.2	29.2	26.5	27.6	27.5	27.0	28.5	31.4	35.3	37.6	33.9	36.2
27	IS7025si - IS8010si	30	30	26.7	23.5	24.6	25.9	26.9	28.1	29.5	29.8	29.8	26.6	25.1	26.4	28.4	31.0	33.8	35.6	35.7	36.6
	IS7025si - IS8011si	30	30	25.9	23.0	24.9	26.1	26.4	27.7	29.0	28.9	29.3	27.3	25.4	27.1	29.1	31.5	33.7	35.4	35.4	35.5
	IS7025si - IS8090si	30	30	26.2	23.5	25.3	26.6	27.0	28.1	29.5	29.5	29.9	27.4	25.7	27.5	28.9	31.5	33.9	35.8	36.3	37.7
	IS7080si - IS8011si	31	31	24.5	24.4	26.3	32.3	30.6	28.9	29.2	28.5	25.6	27.6	29.4	28.5	32.2	35.7	38.0	38.5	38.7	37.0
28	IS7080si - IS8020si	31	31	25.2	24.3	26.6	33.5	30.7	29.2	29.0	28.7	26.2	27.9	29.2	28.8	32.7	36.2	38.2	38.8	40.2	43.1
Single Proprietary Fire Door - nom. 47mm thick																					
	Fully caulked	33	33	21.0	21.3	25.4	29.7	28.5	28.3	28.1	27.9	28.2	28.9	31.1	33.7	35.9	38.1	40.3	42.1	43.0	45.0
	KG1612BW - IS8005si	30	30	31.5	24.7	27.6	30.1	30.0	29.1	29.8	30.0	26.8	26.6	29.0	30.2	32.5	33.6	33.1	32.7	34.4	34.4
	KG1612BW - IS8010si	30	30	30.3	23.8	27.2	29.2	28.9	27.9	28.7	28.9	28.9	25.7	25.6	28.5	30.2	32.2	34.4	34.6	33.4	35.0
	KG1612BW - IS8011si	30	30	31.1	23.4	26.9	29.6	29.0	27.8	28.5	29.3	29.1	26.0	26.1	28.4	30.1	32.4	34.6	34.7	33.6	34.7
29	KG1612BW - IS8035si	30	30	31.8	24.4	27.2	30.0	29.1	28.5	29.4	29.7	29.7	25.8	26.0	28.3	29.6	31.5	33.6	33.7	32.8	34.3
	IS1212 - IS8005si	30	30	29.2	24.6	26.6	29.6	30.2	28.3	29.6	29.9	29.7	26.8	26.7	30.0	31.5	32.8	33.3	31.9	32.5	35.5
24	IS1212 - IS8010si	30	31	29.3	25.1	26.5	28.7	28.9	27.3	27.9	28.8	29.0	25.7	26.0	29.7	31.8	33.6	36.4	37.0	38.1	40.0
25	IS1212 - IS8011si	31	31	27.7	22.1	26.8	28.3	27.3	27.6	29.3	29.3	29.2	24.9	26.6	30.1	32.1	32.9	34.3	35.3	35.3	35.9
	IS1212 - IS8035si	31	31	29.3	24.7	27.1	29.9	29.7	28.5	29.2	30.1	29.7	26.6	26.8	29.4	30.7	32.1	34.9	36.0	36.5	37.4
	IS7025si - IS8005si	31	31	31.0	24.6	27.7	30.6	30.3	29.6	30.0	30.1	30.2	27.2	25.9	28.2	31.2	33.8	35.2	34.6	34.7	37.3
27	IS7025si - IS8010si	31	31	26.2	22.5	27.0	27.9	27.2	28.5	29.9	30.0	30.4	25.3	26.2	27.8	30.7	33.6	35.2	35.6	36.3	38.6
	IS7025si - IS8011si	31	31	30.4	25.1	27.0	30.9	29.9	29.2	29.3	30.3	30.1	27.3	26.3	28.5	31.8	34.9	37.0	38.0	38.4	39.6
	IS7025si - IS8035si	31	31	31.2	24.1	27.4	31.3	30.4	29.6	29.9	30.5	30.4	26.7	26.1	28.4	31.6	34.2	36.7	38.1	38.6	40.0
	IS7025si - IS8090si	31	31	26.3	23.0	27.4	27.9	27.2	28.3	29.6	30.0	30.4	26.3	26.2	27.8	30.3	32.7	35.2	36.1	36.5	36.6
30	IS7080si - IS8090si	31	31	30.4	24.6	27.0	30.4	30.0	29.9	30.0	29.0	29.3	27.0	26.4	29.0	32.0	34.6	36.4	36.2	38.6	38.6
31	IS7195si - IS8090si	32	32	32.2	24.5	27.3	30.4	29.7	29.5	30.4	30.6	30.7	27.3	26.7	29.2	31.8	34.6	36.8	37.6	38.9	39.0
Proprietary Fire Door Pairs - nom. 47mm thick																					
	Fully caulked	32	32	28.8	27.7	27.7	29.1	29.5	30.0	30.1	29.1	27.8	26.7	29.0	32.5	35.2	37.2	39.2	41.0	42.3	43.1
32	IS1212 - FDMS-TP - IS8010si	31	31	24.5	23.4	27.7	28.2	29.3	29.3	29.8	29.6	28.8	25.6	26.6	30.2	31.6	33.1	34.5	35.4	35.6	36.6
	IS1212 - FDMS-TP - IS8011si	31	31	24.1	24.6	27.9	28.7	29.9	29.4	30.9	30.1	29.0	26.2	27.2	30.6	31.9	33.1	34.6	36.3	36.7	36.6
	IS1212 - FDMS-TP - IS8020si	31	31	24.1	24.8	27.9	27.9	28.8	28.7	29.8	29.8	29.0	25.9	27.0	30.2	31.9	33.4	35.3	36.6	37.1	37.1
	IS1212 - FDMS-TP - IS8090si	31	31	24.8	23.9	28.2	28.9	29.9	29.6	30.7	30.4	29.2	26.5	27.3	30.5	32.3	33.4	35.3	36.7	37.2	37.2
	IS7025si - FDMS-TP - IS8010si	30	30	23.2	23.4	27.1	27.8	28.7	28.1	28.4	28.5	27.6	25.4	26.0	27.9	29.8	32.5	33.6	34.0	34.3	35.8
	IS7025si - FDMS-TP - IS8011si	31	31	23.9	25.4	27.4	29.0	30.0	29.3	30.7	29.8	29.3	26.9	27.0	28.9	31.1	33.4	35.5	37.1	37.0	37.5
	IS7025si - FDMS-TP - IS8020si	31	31	23.7	24.7	27.2	28.0	28.7	28.7	29.9	29.1	28.3	26.5	27.0	28.6	31.0	32.8	35.6	36.9	37.4	38.3
	IS7025si - FDMS-TP - IS8090si	31	31	24.2	24.2	27.7	28.9	29.3	29.4	30.8	30.1	29.3	26.8	27.0	28.9	31.0	33.0	35.0	36.9	37.2	37.9
	IS7080si - FDMS-TP - IS8010si	31	31	23.9	24.5	27.6	29.4	29.8	29.4	30.1	29.0	28.4	26.2	26.5	28.7	31.5	33.4	35.0	35.4	37.4	38.3
	IS7080si - FDMS-TP - IS8020si	31	31	23.7	24.1	27.6	29.5	30.5	30.4	30.9	29.7	28.9	26.8	27.1	29.2	31.8	33.7	35.4	35.6	38.6	38.8
	IS7080si - FDMS-TP - IS8090si	31	31	23.8	23.2	27.9	29.2	30.1	29.8	30.6	29.7	28.9	26.6	27.0	29.2	31.7	33.6	35.3	35.6	38.3	38.2
33	KG1612BW - FDMS-TP - IS8010si	30	30	25.4	24.5	27.4	28.1	29.2	29.1	29.0	29.1	28.6	25.5	26.8	29.6	30.2	30.4	31.6	32.8	32.6	30.3
	KG1612BW - FDMS-TP - IS8090si	30	29	25.6	24.4	27.9	28.8	29.9	29.0	29.7	29.5	28.7	26.2	26.9	29.6	30.4	29.7	30.8	32.3	32.1	29.8

Contact Kilargo for additional acoustic sealing systems approved for proprietary fire-rated doors.

Proprietary Acoustic Doors

Where there's a requirement for greater acoustic performance, for example, in plant rooms, medical surgeries, school music rooms, theatres, cinemas, adjoining hotel rooms, etc, door assembly constructions need to meet much higher acoustic ratings in order to ensure privacy.

Working in partnership with specialist door manufacturers, Kilargo has tested a wide selection of sealing combinations to meet the demanding acoustic performance requirements necessary for tailored door applications.

REF IS1515/IS6030 - IS8090si
34

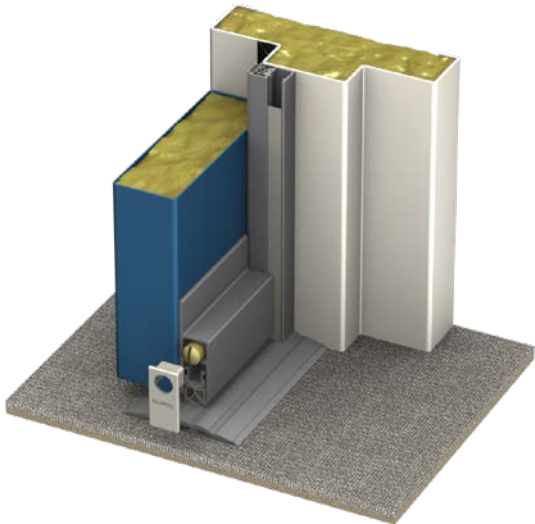

Door Thickness	Rw	STC
45mm	42	42

REF IS1046si - IS4220si
35

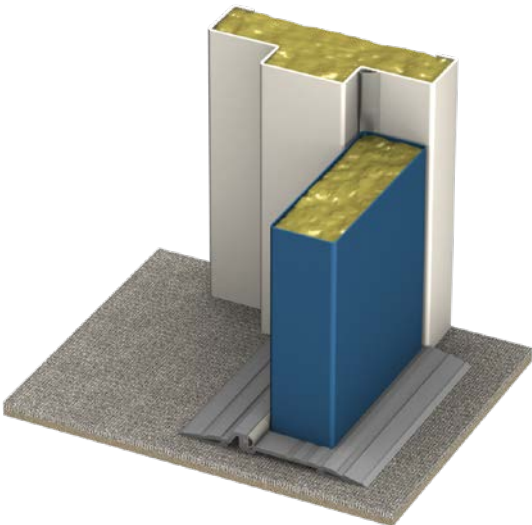

Door Thickness	Rw	STC
45mm	36	36

REF IS7195si - IS8520si
36

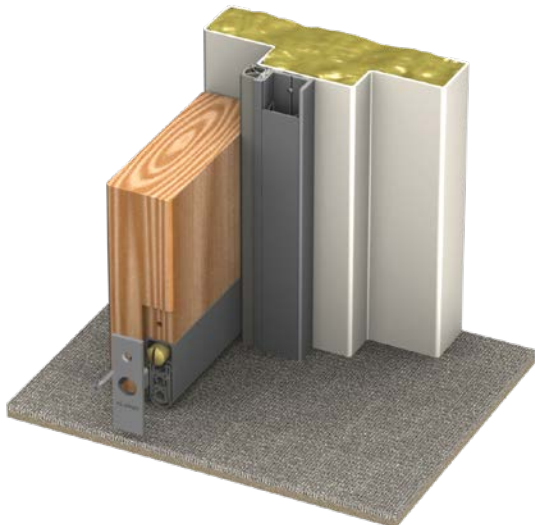

Door Thickness	Rw	STC
46mm	36	36

Acoustic Sealing Solutions

Proprietary Acoustic Doors



REF IS1515/IS7087si - IS8520si
37



Door Thickness	Rw	STC
46mm	37	37

REF IS1515/IS7080si - IS8090si
38

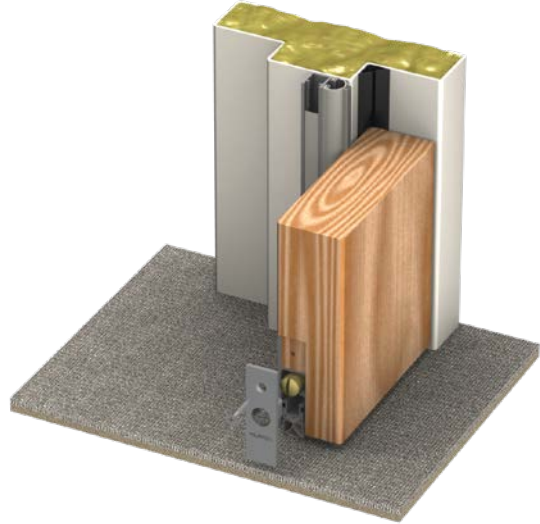

Door Thickness	Rw	STC
46mm	37	38

REF IS1515/IS7087si - IS8090si
39



Door Thickness	Rw	STC
48mm	42	42

REF IS1212/IS0511/IS7080si - IS8010si - IS4220si
40

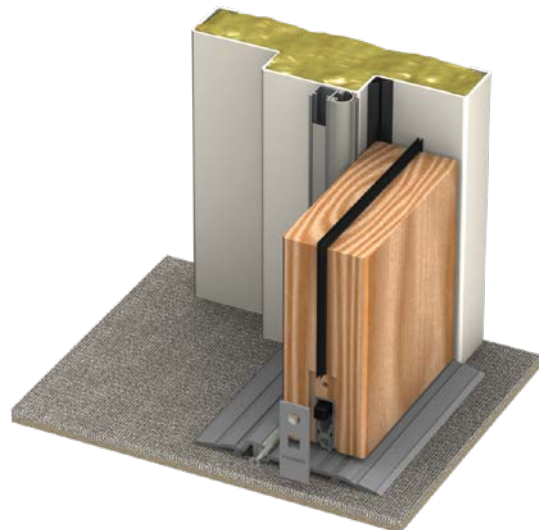

Door Thickness	Rw	STC
58mm	48	48

Proprietary Acoustic Doors



REF IS1515/IS7087si - IS7060si x 2 -
41 IS8520si - IS4226si

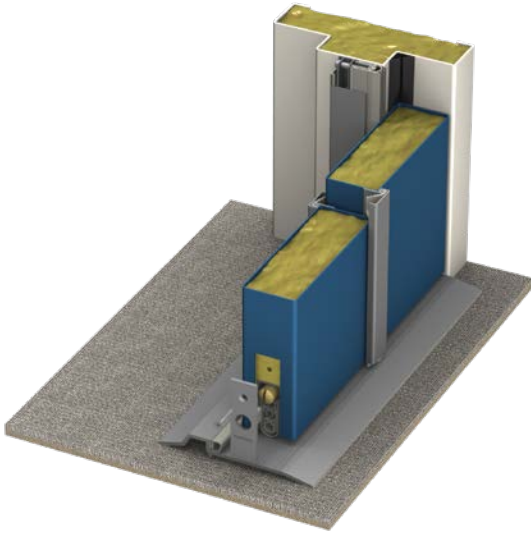

Door Thickness	Rw	STC
50mm	44	45

Test Ref	Sealing System	Rw	STC	Frequency (Hz) / STL (dB)																	
				100	125	160	200	250	315	400	500	630	800	1000	1250	1600	2000	2500	3150	4000	5000
Single 45mm Acoustic Steel Door with backfilled Steel Frame																					
	Fully caulked	50	52	22.2	29.1	35.6	42.1	43.7	44.5	46.8	50.6	52.1	53.4	53.9	52.3	52.0	51.2	54.1	56.6	58.5	56.7
34	IS1515/IS6030 - IS8090si	42	42	20.6	28.5	36.5	42.4	43.3	46.5	44.4	43.0	42.2	42.2	43.4	43.7	41.2	39.9	42.0	44.3	44.7	43.7
	IS1515 - IS8090si	39	39	21.4	29.0	35.3	42.1	43.6	48.1	44.0	39.5	38.2	38.0	4.3	41.0	39.3	36.5	37.7	40.1	41.5	40.0
	IS1046si - IS7025si - IS4220si	40	40	26.6	24.4	30.1	36.3	34.9	33.6	37.2	38.6	37.6	38.0	38.5	40.5	42.3	41.3	40.5	40.9	43.5	47.5
	IS7085si - IS8011si	41	41	18.5	28.1	34.0	44.1	43.9	48.5	44.3	45.1	44.4	43.4	40.6	38.2	39.2	42.0	43.1	43.1	42.5	40.7
35	IS1046si - IS4220si	36	36	26.0	24.2	29.7	35.8	34.1	33.3	36.8	37.9	36.1	36.3	36.2	36.9	37.9	35.0	32.2	34.5	36.7	40.2
Single 50mm Acoustic Steel Door with backfilled Steel Frame																					
	IS1046si - IS4220si	43	43	24.5	28.7	29.5	34.9	35.2	37.8	40.4	41.1	44.2	44.2	42.6	42.1	43.5	43.9	45.0	47.8	48.6	46.9
	IS1046si - IS7025si - IS4220si	43	43	24.6	29.2	29.8	34.9	35.0	37.8	40.1	41.3	44.5	44.5	43.1	42.4	43.6	43.7	45.8	48.8	50.3	50.5
	IS1046si - IS7087si - IS8110si - IS4220si	44	45	24.6	30.8	30.6	35.2	37.2	40.2	41.6	42.0	45.8	45.9	44.3	43.7	46.4	45.9	44.3	47.4	49.9	51.3
45mm Acoustic Steel Door Pair with backfilled Steel Frame																					
	IS1515 - IS7025si - IS7060si - IS4220si - IS3080si (door bottom)	46	46	24.7	27.8	31.3	33.3	36.0	38.7	42.4	44.0	46.5	47.2	46.6	48.4	49.8	49.7	47.4	48.3	48.5	49.1
56mm Acoustic Steel Door Pair with backfilled Steel Frame																					
	IS1046si - IS7087si - IS8520si - IS4226si	43	43	27.9	28.1	32.0	37.3	36.7	37.9	39.8	40.8	42.1	42.5	42.8	41.5	41.5	43.0	45.2	49.4	49.6	49.8
	IS1515 - IS1046si - IS7025si - IS4220si	46	47	26.4	28.5	33.3	36.9	36.6	40.5	42.5	43.7	45.1	47.0	47.8	46.2	47.3	50.3	51.6	50.9	49.5	49.2
Single 46mm Timber Composite Acoustic Door with backfilled Steel Frame																					
	Fully caulked	43	43	28.5	27.7	26.1	30.3	41.5	51.6	41.9	43.9	45.7	44.9	45.0	42.2	38.9	44.5	43.8	44.9	46.3	46.9
36	IS7195si - IS8520si	36	36	31.6	26.8	30.2	32.3	32.8	33.3	34.4	34.0	35.2	34.9	34.8	32.7	33.4	35.9	38.2	40.2	41.8	43.8
37	IS1515/IS7087si - IS8520si	37	37	32.0	27.3	31.5	31.8	32.4	32.9	34.5	34.4	35.8	35.4	36.2	37.2	35.6	36.4	38.2	41.1	42.9	45.4
38	IS1515/IS7080si - IS8090si	37	38	26.2	23.8	25.5	31.2	41.4	39.7	36.5	37.9	35.7	33.8	33.6	35.7	35.7	40.5	41.3	41.6	43.0	41.2
	IS1515 - IS7090si - IS8090si	37	37	28.0	24.2	25.0	31.5	36.9	36.5	36.0	36.6	34.9	35.6	35.4	36.9	36.0	37.7	37.9	39.1	40.3	40.9
Single 48mm Timber Composite Acoustic Door with backfilled Steel Frame																					
	Fully caulked	45	45	32.1	29.5	31.4	39.3	37.1	37.1	39.9	42.1	43.1	46.0	46.8	47.2	48.9	49.7	48.2	47.3	48.5	50.2
	IS1212 - IS8011si - IS4130	38	38	30.8	32.0	35.2	37.4	34.9	35.8	36.1	36.6	37.3	39.4	40.1	39.6	37.7	37.4	37.5	39.5	40.1	-
	IS1212 - IS7025si - IS8011si - IS3080si (door bottom) - IS4130	42	42	30.8	32.0	35.3	38.2	36.6	37.0	35.9	37.0	39.0	41.5	43.2	44.4	43.1	42.6	42.6	46.0	48.4	-
39	IS1515/IS7087si - IS8090si - IS4130	42	42	29.4	26.5	31.9	36.3	34.8	36.3	38.5	40.2	41.4	43.3	44.4	44.9	45.0	43.9	42.9	42.6	44.1	-
Single 58mm Timber Composite Acoustic Door with backfilled Steel Frame																					
	Fully caulked	49	50	37.1	39.1	36.4	43.6	39.6	42.5	44.7	46.1	47.5	48.1	49.0	50.1	51.8	52.3	51.2	52.5	53.9	55.6
	IS1212 - IS8010si - IS8011si (dual door bottom seals)	45	45	36.0	40.0	36.3	42.3	39.1	41.6	40.1	41.5	41.8	43.2	45.2	46.7	46.3	48.5	48.2	49.6	50.4	51.0
	IS1212 - IS8010si - IS4220si	46	46	36.5	40.4	39.3	42.7	40.2	41.2	42.4	43.4	43.4	45.4	46.1	46.8	47.0	48.2	47.9	49.9	50.2	48.9
	IS1212 - IS7025si - IS8010si - IS8011si (dual door bottom seals)	46	47	34.6	38.0	37.1	41.6	38.9	39.8	40.6	42.3	42.8	44.4	45.7	46.8	47.5	48.5	47.1	49.4	50.5	50.1
40	IS1212/IS0511/IS7080si - IS8010si - IS4220si	48	48	38.0	39.0	38.4	44.1	41.3	43.8	43.9	44.4	45.3	46.4	47.9	48.3	49.2	50.5	49.6	51.0	52.1	54.6
50mm Acoustic Steel Door Pair with backfilled Steel Frame																					
41	IS1515/IS7087si - IS7060si x2 - IS8520si - IS4226si	44	45	21.1	27.8	33.6	40.1	39.5	41.4	42.3	43.4	43.6	41.7	43.0	43.1	45.0	46.3	48.6	50.1	49.8	50.5
64mm Timber Composite Acoustic Door with Timber Frame																					
	IS7080si - IS0511 - IS8520si	41	41	30.5	30.2	34.2	28.8	29.5	33.4	38.1	39.3	40.0	40.7	41.9	43.1	41.9	41.9	42.5	45.4	48.3	50.2

Contact Kilargo for additional acoustic sealing systems on proprietary acoustic doors.

SMOKE

Door Sealing Solutions



Smoke Door Sealing Solutions Overview

Building regulations require that large building volumes are sub-divided into smaller compartments to resist the spread of fire and smoke.

Constructing an impermeable smoke barrier is a relatively simple task, however, more complex is providing smoke protection for the doorways which need to be formed in this barrier for the building to function effectively.

To operate effectively, doors require clearances between the door leaf and frame, and between the bottom of the door and floor. These clearances allow the door to be opened and closed easily and accommodate normal building movement. However if these clearances are left unsealed they are vulnerable to the passage of fire, smoke and sound.

One might expect a tested and proven fire door to also provide smoke protection as a matter of course. Unfortunately, in most instances, this is not so. If the door is not fitted with an additional smoke seal then large quantities of smoke will pass through the perimeter gaps. Tests show that with a conventional 25mm door stop, a fire door is a very poor smoke barrier. Smoke leakage in excess of 340m³/hour can be expected!

The principles of smoke containment are quite different from fire containment, even though the compartment boundaries may be the same. A typical door assembly will quite probably be exposed to smoke, independently of fire (in testing and in practice) - so it needs to be separately designed and evaluated for smoke.

The Nature of Smoke

When fire breaks out in a building the threat is two-fold. Firstly there is the fire itself and the hot noxious gases and smoke generated in the immediate vicinity. Secondly there is dense toxic smoke which migrates away from the fire source. If left unchecked this smoke will rapidly spread to adjacent compartments and pose a significant threat to people some distance away from the fire.

It is now agreed that this "remote smoke" is a major contributor to fatalities and serious injuries in structural fires.

In a fire situation, the efficient combustion of any fuel with a plentiful supply of oxygen will yield practically no smoke, just relatively harmless Carbon dioxide (CO₂) and water vapour. However, in a confined space, such as a room in a building, there will be a rapid depletion in available oxygen and inefficient combustion will result. This will lead to large quantities of carbon monoxide (CO), nitrogen dioxide (NO₂) and hydrogen cyanide (HCN) to evolve, as well as unburned particles of fuel that result in thick smoke.

The level of carbon monoxide in the atmosphere is almost immeasurable at 0.1ppm (or 0.00001%), but when the level increases to as low as 1% in a confined space it can be considered lethal. Through the lungs this gas is absorbed preferentially into the bloodstream where it binds with red blood cells and prevents the uptake of oxygen necessary for the brain to function.

To survive, humans require a minimum of 14% oxygen and without this, dis-orientation will occur in as little as 20 seconds; unconsciousness in about a minute; and death by asphyxiation shortly after.

Smoke Behaviour

If we take the example of a fire in a room; from the seat of the fire, there will be produced a plume of smoke. Hot gases are less dense and so they rise due to their buoyancy, carrying the soot particles through entrainment and associated turbulence. The plume will continue to rise, so long as it is hot and therefore buoyant, or, until it meets an obstruction, such as the ceiling. On meeting this obstruction it will begin to spread sideways, driven by the continuously expanding gases behind it. In a closed compartment, a PRESSURE will be created by this combustion process and this pressure needs to be taken into account in all design considerations particularly at the door.

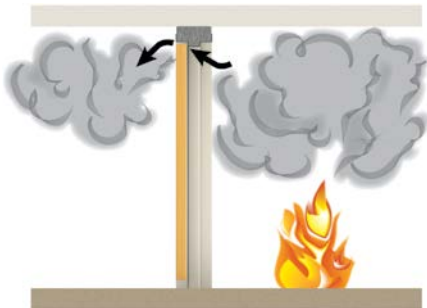

The method of smoke transfer is first of all at ceiling level, due to its buoyancy, then along paths of least resistance, and under significant pressure. These are basic laws of physics, so it is inevitable that the smoke will spread if unhindered. It is also obvious that the smoke front will travel greater distances than the flame front, and at much higher speed. The main reasons in fact, for the higher casualties from smoke.



Further away from the room of origin, the smoke will have cooled and lost some of its buoyancy so it will come down more to floor level but will still be under some pressure. It will also still be highly toxic.

In order to limit that smoke spread, the Kilargo solution is to fit an appropriate sealing system which, when properly located and secured, can help in preventing the passage of smoke from one compartment to the next.

Smoke Temperature Classifications

Door perimeter sealing systems will vary depending on the design temperature at which they are required to contain smoke.

Smoke is typically defined in three (3) categories:

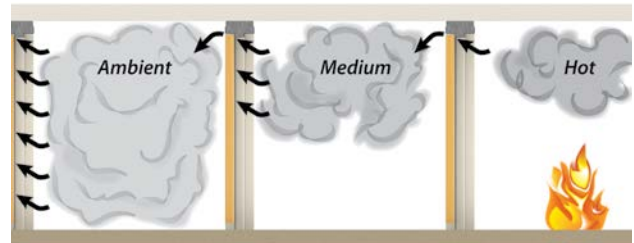

Ambient Smoke: (or cold smoke) is smoke at a relatively cool temperature. This smoke is quite remote from the source of the fire and has little or no buoyancy.

Medium Temperature Smoke: is defined as smoke at 200°C. The Building Code of Australia currently requires smoke doors to resist the passage of smoke at 200°C for 30 minutes. Research has shown that medium temperature smoke is encountered adjacent to the room of fire origin and may also represent the conditions within a room of fire origin during a sprinkler controlled fire scenario.

Hot Smoke: is defined as smoke at temperatures in excess of 600°C. Typically hot smoke is associated with a fully developed fire scenario in the room of fire origin.

Smoke Door Application

Smoke door assemblies are designed to improve life safety in buildings by limiting the spread of smoke through door openings and ensuring egress paths remain un-obscured and tenable.

Typical applications include:

Lift lobby's: where smoke doors are utilized to create a refuge and keep the lobby area free of smoke in the event of fire.

Hospitals: where immobility of patients necessitates extended evacuation times and greater levels of protection through smoke compartmentation.

Hotel or multi-residential: unit entry type doors, where tenability in the common escape corridor is vital.



Current Australian Smoke Door Regulations

Deemed to Satisfy Construction

The Building Code of Australia (BCA) provides limited information in relation to smoke doors.

Specification C3.4* requires that "Smoke doors must be constructed so that smoke will not pass from one side of the doorway to the other" and provides the following "deemed to satisfy" guidance:

A smoke door of one or two leaves satisfies Clause 3.1 if it is constructed as follows:

- (a) *The leaves are side-hung to swing—*
 - (i) *in the direction of egress; or*
 - (ii) *in both directions.*
- (b) (i) *The leaves are capable of resisting smoke at 200°C for 30 minutes.*
- (ii) *Solid-core leaves at least 35mm thick satisfy (i).*
- (c) *The leaves are fitted with smoke seals .*
- (d) (i) *The leaves are normally in the closed position;or*
 - (ii) (A) *The leaves are closed automatically with the automatic closing operation initiated by smoke detectors, installed in accordance with the relevant provisions of AS 1670.1, located on each side of the doorway not more than 1.5 m horizontal distance from the doorway; and*
 - (B) *in the event of power failure to the door, the leaves fail-safe in the closed position.*

- (e) *The leaves return to the fully closed position after each manual opening.*
- (f) *Any glazing incorporated in the door complies with AS 1288.*
- (g) (i) *If a glazed panel is capable of being mistaken for an unobstructed exit, the presence of the glass must be identified by opaque construction.*
- (ii) *An opaque mid-height band, mid-rail or crash bar satisfies (i).*

***Unfortunately this specification creates some confusion, particularly with regard to:**

1. the perceived zero smoke leakage requirement
2. the "solid core" door construction, which remains undefined
3. the requirement for the smoke seals to be fitted to the door leaves to comply.

Performance Based Solutions

The Building Code of Australia allows provision for the use of "Performance Based Alternate Solutions".

The introduction of two important Australian Standards has allowed fire engineers and building practitioners to specify smoke doors with quantifiable levels of performance with the knowledge that installed assemblies will meet their building design requirements. They are:

AS6905:2007 – Smoke Doors

AS1530.7:2007 – Smoke control assemblies – Ambient and medium temperature leakage test procedure.

¹ The Standard Reference Conditions are defined as the temperature of 293.15 K (20°C) and the pressure of 101,325 Pa.

² Please contact Kilargo for detailed information on relevant tested Proprietary door systems.

AS6905 covers the specification, construction, installation and identification of smoke doors. The standard requires that assemblies are tested in accordance with the conditions detailed in AS1530.7, and most importantly it defines the maximum allowable smoke leakage rates for single and double door assemblies at prescribed temperature and pressure differentials.

When tested in accordance with AS1530 Part 7, the smoke door leakage rates shall not exceed the following:

- (a) **Single leaf smoke doors**—40m³/h at medium temperature conditions (25m³/h corrected to Standard Reference Conditions¹), at a pressure differential of 25Pa after exposure at 200°C for at least 30 min when subjected to a test in accordance with AS1530.7.
- (b) **Double leaves smoke doors**—65m³/h at medium temperature conditions (40m³/h corrected to Standard Reference Conditions¹), at a pressure differential of 25Pa after exposure at 200°C for at least 30 min when subjected to a test in accordance with AS1530.7.

AS1530.7 is a test method that allows the measurement of smoke leakage from one side of a door assembly to the other under elevated temperature test conditions.

The test methodology involves fitting a full size door assembly, including all essential hardware, to an approved test chamber in which temperature and pressure conditions are controlled. Ordinary air is used in the chamber, simulating the carrier gases of real smoke. Pressures are applied and resulting "leakages" through the test assembly are measured to determine its effectiveness as a barrier to resist smoke. Measurements are taken at pre-determined periods that provide data to align with the BCA deemed to satisfy regime of 30 minutes exposure at 200°C.



When subjected to elevated temperatures, a door assembly, will go through progressive changes and deflection and distortion of the door leaf is a commonly encountered problem. Incompatible door and seal combinations that cannot cater for this door movement will result in excessive leakage rates and consequently poor performance.

Kilargo Smoke Sealing Solutions

Kilargo have performed numerous ambient & medium temperature tests with door companies on a variety of Proprietary doors.²

Together with a detailed knowledge of fire & smoke containment, we can confidently offer the following performance tested and recommended 'deemed to satisfy' solutions to various smoke door applications.

For further information on the smoke performance of the Kilargo range of door sealing solutions, please feel free to contact our Technical Department for advice.

'DTS' BCA Specification C3.4



'Deemed to Satisfy' BCA Solutions – for applications with NO Fire-Engineered specification, designed to meet the provisions set out in Specification C3.4 of the Building Code of Australia.

The sealing components utilized for these applications are generally extruded silicone, or materials with a proven temperature resistance above 200°C, **fitted to the door leaf (leaves).**



IS0511 - IS8010si

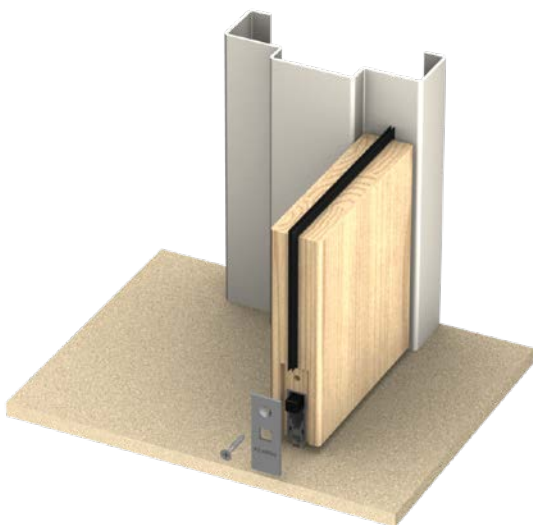

Door Thickness
Minimum 35mm

KP1504TS - KP3504TF

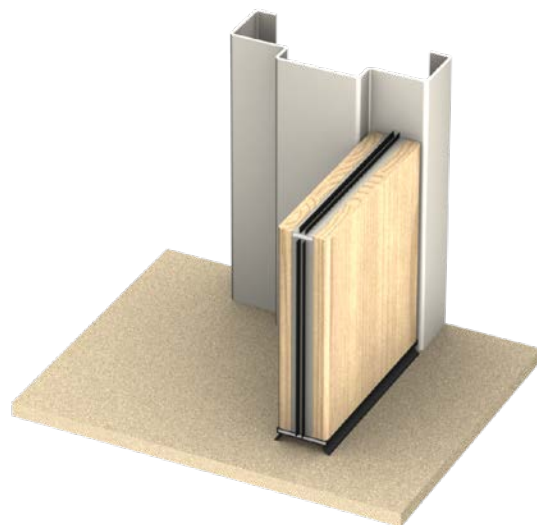

Door Thickness
Minimum 35mm

'DTS' BCA Specification C3.4



IS0511 - IS8011si

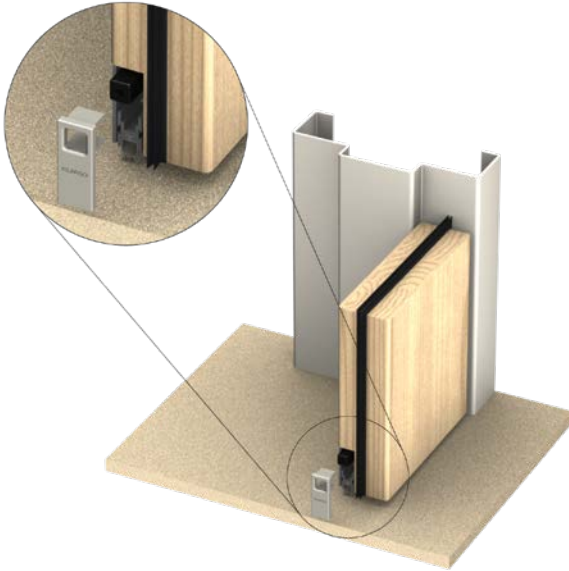

Door Thickness
Minimum 35mm

IS7071si x2 - IS3022si

*Shown with an IS4010 threshold plate.

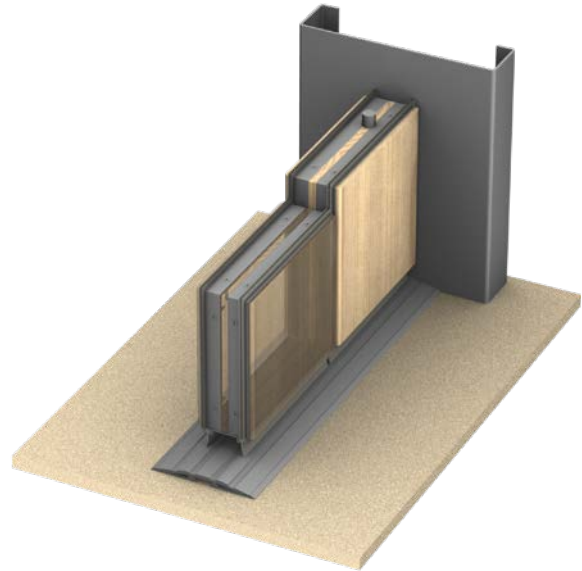

Door Thickness
Minimum 35mm

IS0511 - KP3504TF

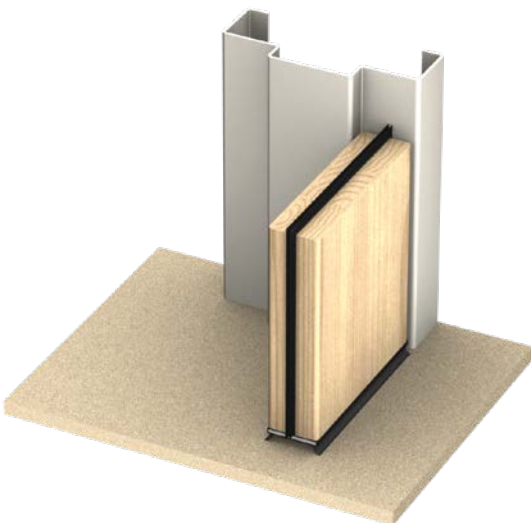

Door Thickness
Minimum 35mm

IS7350si - IS7355si - IS5111si



Door Thickness
Minimum 10mm

'DTS' BCA Specification C3.4



IS0511 x2 - IS8090si

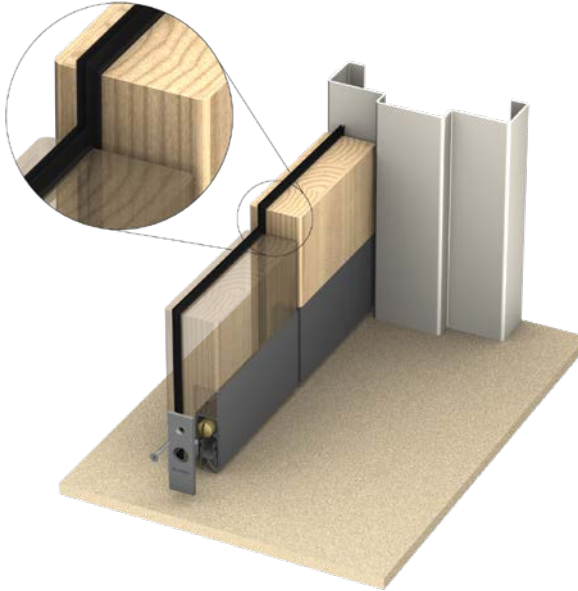

Door Thickness

Minimum 35mm

KP2004TS x2 - KP4202TF

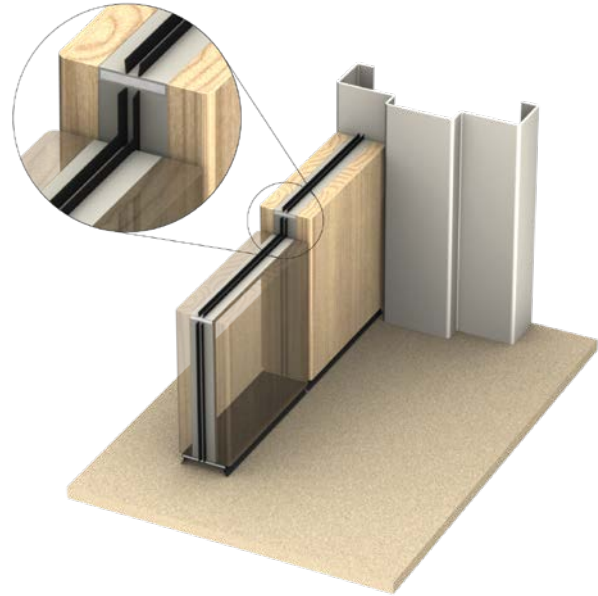

Door Thickness

Minimum 45mm (allowing for KP4204TF seals)

Solid Core Door Systems (Tested in Accordance with AS1530 Part 7)





Alternate Performance Tested Solutions – tested to AS1530.7 with proven medium temperature smoke leakage rates across various pressures, as per the leakage rate guidelines set out in AS6905.

These systems incorporate a complete tested door assembly, including a proprietary door and selected performance door seals, combining to cater for door movement and provide the best leakage rates possible within the specified parameters.

As per the guidelines set out in AS6905, side-hung smoke doors must be tested opening towards and away from the heated enclosure unless the direction of exposure can be clearly identified. If the leakage test report for your application only has results from one direction, you may not have the results from the direction you need.

AS1530 Part 7. 2007 states that results from each direction are required for specimens tested at medium temperature. It is therefore important to determine the orientation for your application prior to specification, ensuring the correct medium temperature leakage data is applied.

(Refer to specified tables for tested system orientations)



REF 1 IS1212 - IS8010si

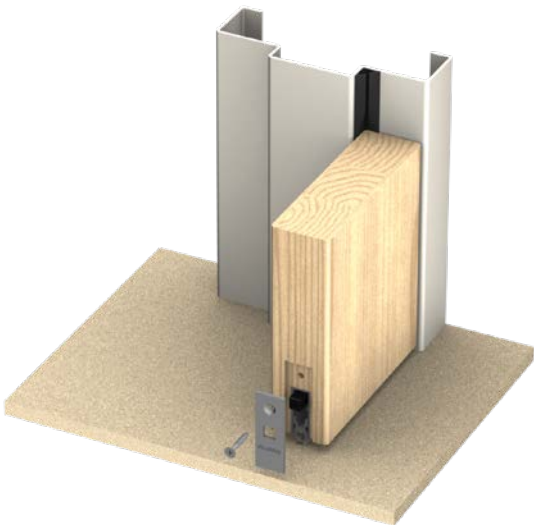

Door Thickness
35mm

REF 2 IS1212 - IS8035si (FF)

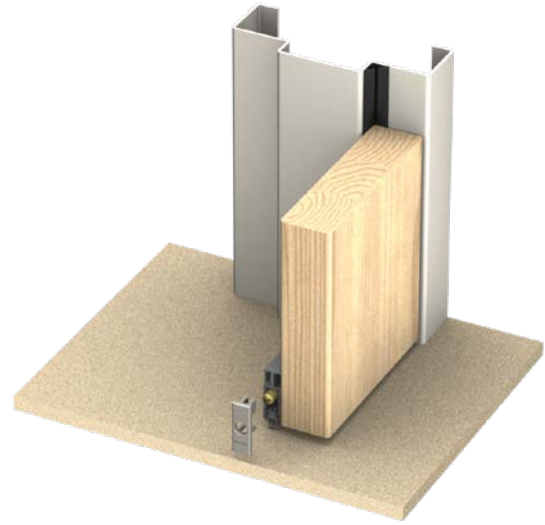

Door Thickness
40mm

Smoke Door Sealing Solutions

Solid Core Door Systems (Tested in Accordance with AS1530 Part 7)



REF **KG1612BW - IS8005si**
3

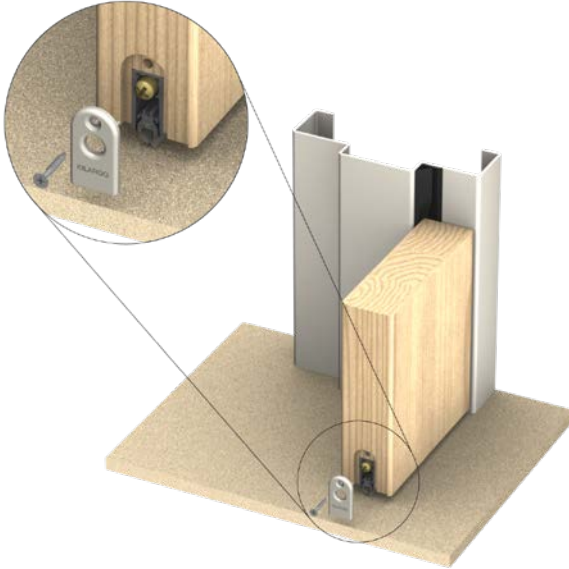

Door Thickness
40mm

REF **KG1612BW - IS8090si (SM)**
4

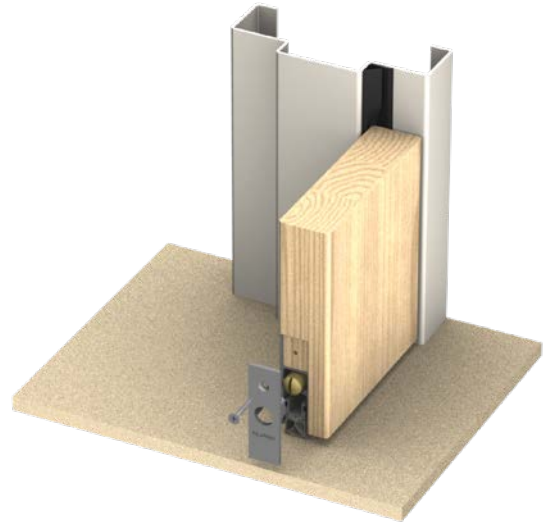

Door Thickness
40mm

REF **IS7025si - IS8010si**
5

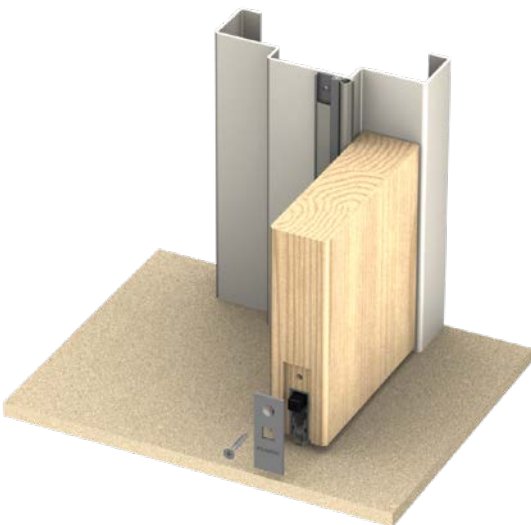

Door Thickness
40mm

REF **IS7025si - IS8011si (FF)**
6

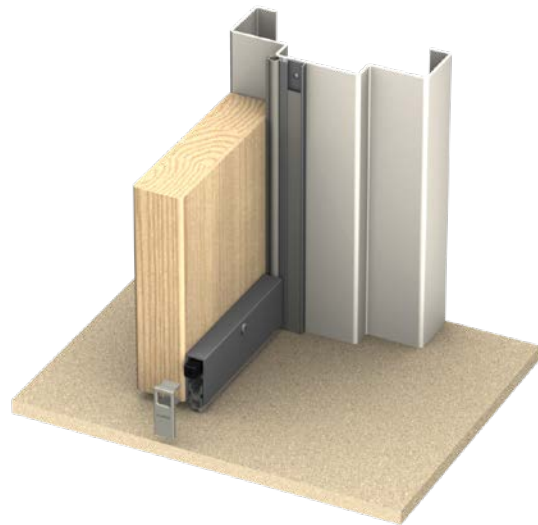

Door Thickness
40mm

Solid Core Door Systems (Tested in Accordance with AS1530 Part 7)



REF IS7080si - IS8010si
7

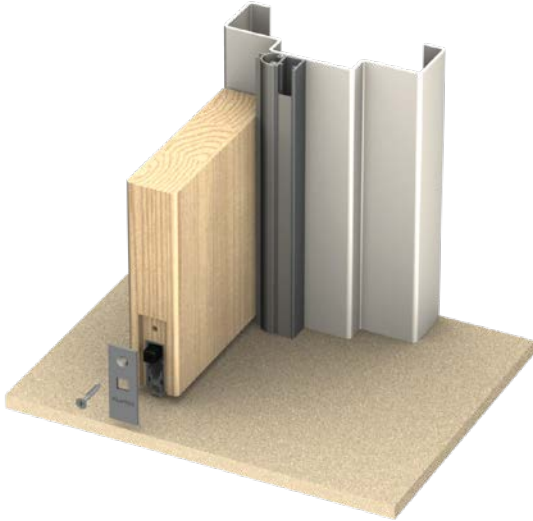

Door Thickness
40mm

REF IS7080si - IS8090si (SM)
8

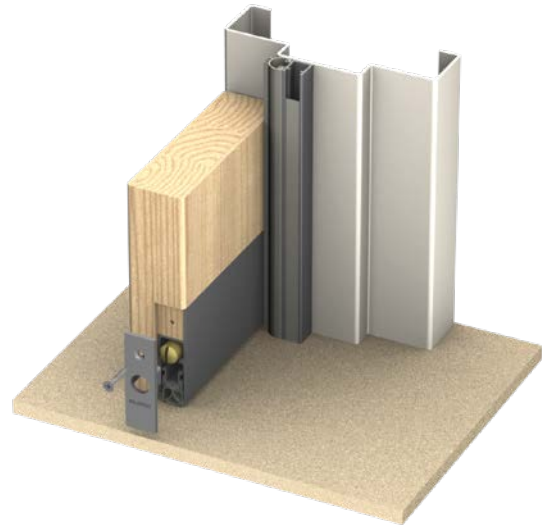

Door Thickness
40mm

REF IS7080si - IS8520si (SM)
9

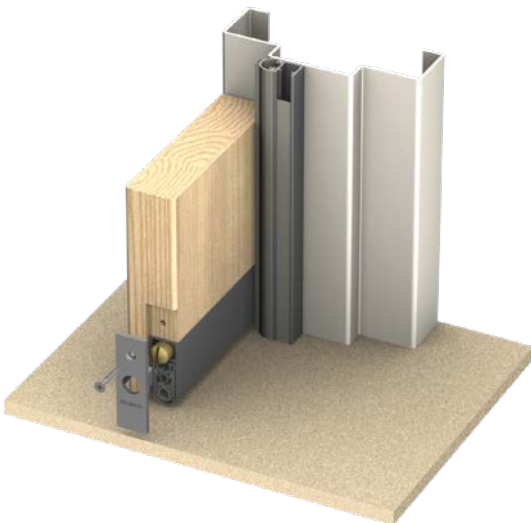

Door Thickness
40mm

REF IS7195si - IS8530si
10

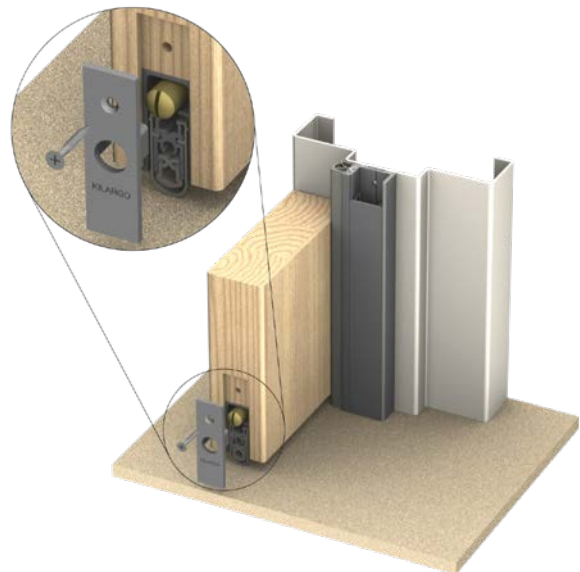

Door Thickness
40mm

Solid Core Door Systems (Tested in Accordance with AS1530 Part 7)



REF IS1212 - IS7060si - IS8010si
11

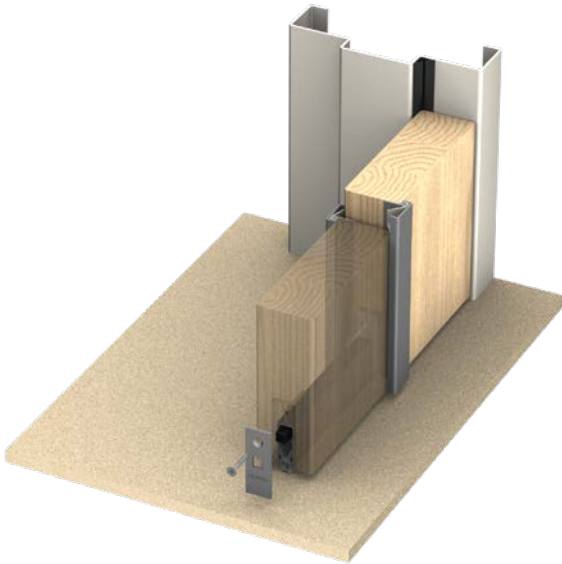

Door Thickness
45mm

REF KG1612BW - IS7061 - IS8520si (SM)
12

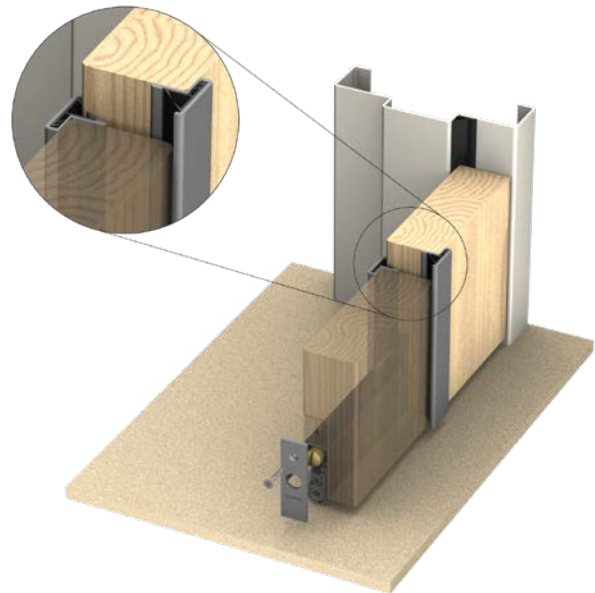

Door Thickness
45mm

REF IS7025si - IS7071si x 2 - IS8035si (SM)
13

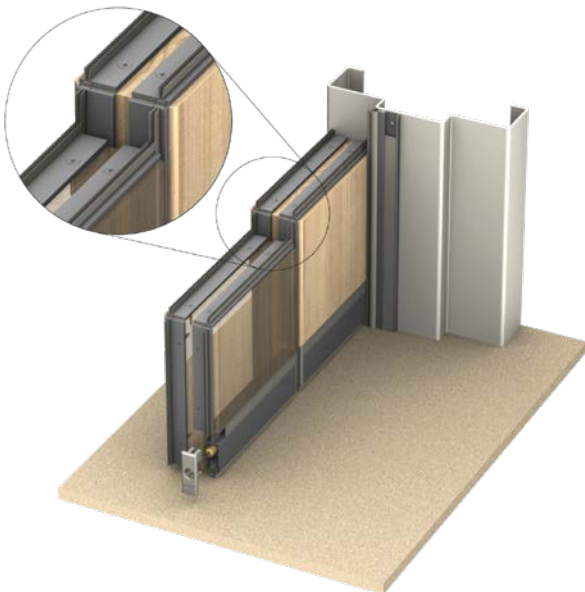

Door Thickness
45mm

REF IS7080si - IS7060si x 2 - IS8090si (SM)
14

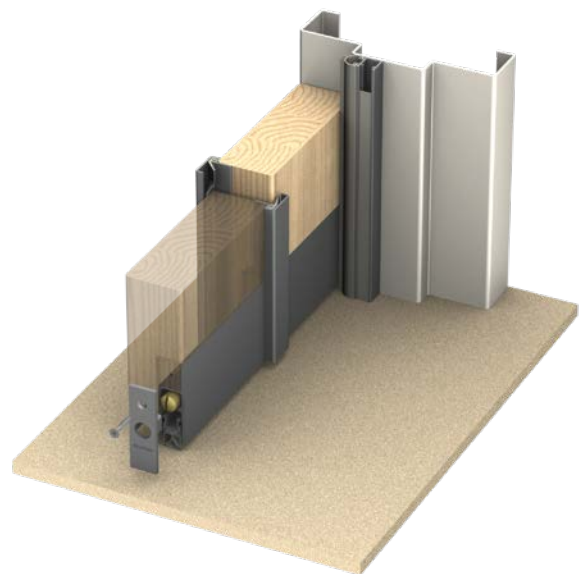

Door Thickness
45mm

Solid Core Door Systems (Tested in Accordance with AS1530 Part 7)



Test Ref	Door Thickness	Config.	Perimeter Seal	Door Bottom Seal	Meeting Stile Seal	Specimen Configuration	Exposure Temp	Leakage Rate Correction	Leakage Rate Q (m³/h) at a pressure differential of:		
									10 Pa	25 Pa	50 Pa
1	35mm	Single	IS1212	IS8010si		Opening away from positive pressure (fire side)	Ambient	SRC	3	4	4
							Medium 200°C	SRC	2	2	2
							Medium 200°C > 30 min	SRC	1	2	3
2	40mm	Single	IS1212	IS8035si (FF)		Opening towards positive pressure (fire side)	Ambient	SRC	1	2	2
							Medium 200°C	SRC	<1	<1	1
							Medium 200°C > 30 min	SRC	17	24	30
3	40mm	Single	KG1612BW	IS8005si		Opening away from positive pressure (fire side)	Ambient	SRC	1	2	3
							Medium 200°C	SRC	2	4	7
							Medium 200°C > 30 min	SRC	5	10	16
4	40mm	Single	KG1612BW	IS8090si (SM)		Opening away from positive pressure (fire side)	Ambient	SRC	2	2	3
							Medium 200°C	SRC	1	2	3
							Medium 200°C > 30 min	SRC	7	11	16
5	40mm	Single	IS7025si	IS8010si		Opening away from positive pressure (fire side)	Ambient	SRC	4	6	8
							Medium 200°C	SRC	2	5	7
							Medium 200°C > 30 min	SRC	6	11	15
6	40mm	Single	IS7025si	IS8011si (FF)		Opening away from positive pressure (fire side)	Ambient	SRC	2	3	4
							Medium 200°C	SRC	2	2	2
							Medium 200°C > 30 min	SRC	4	7	10
7	40mm	Single	IS7080si	IS8010si		Opening away from positive pressure (fire side)	Ambient	SRC	5	8	11
							Medium 200°C	SRC	2	4	7
							Medium 200°C > 30 min	SRC	3	5	8
8	40mm	Single	IS7080si	IS8090si (SM)		Opening away from positive pressure (fire side)	Ambient	SRC	2	3	4
							Medium 200°C	SRC	1	3	5
							Medium 200°C > 30 min	SRC	1	3	6
9	40mm	Single	IS7080si	IS8520si (SM)		Opening away from positive pressure (fire side)	Ambient	SRC	3	4	5
							Medium 200°C	SRC	1	2	2
							Medium 200°C > 30 min	SRC	1	3	5
10	40mm	Single	IS7195si	IS8530si		Opening towards positive pressure (fire side)	Ambient	SRC	4	7	10
							Medium 200°C	SRC	2	4	7
							Medium 200°C > 30 min	SRC	6	9	13
11	45mm	Double	IS1212	IS8010si	IS7060si x2 (Plain rebate)	Opening towards positive pressure (fire side)	Ambient	SRC	7	11	16
							Medium 200°C	SRC	2	5	10
							Medium 200°C > 30 min	SRC	3	8	13
12	45mm	Double	KG1612BW	IS8520si (SM)	IS7061 x2 (Plain rebate)	Opening towards positive pressure (fire side)	Ambient	SRC	5	9	13
							Medium 200°C	SRC	2	4	7
							Medium 200°C > 30 min	SRC	2	6	10
13	45mm	Double	IS7025si	IS8035si (SM)	IS7071si x2 layers (plain rebate)	Opening towards positive pressure (fire side)	Ambient	SRC	3	5	6
							Medium 200°C	SRC	5	8	11
							Medium 200°C > 30 min	SRC	12	18	25
14	45mm	Double	IS7080si	IS8090si (SM)	IS7060si x2 (Plain rebate)	Opening towards positive pressure (fire side)	Ambient	SRC	5	8	11
							Medium 200°C	SRC	3	6	9
							Medium 200°C > 30 min	SRC	20	19	16

Proprietary Fire Rated Doors *(Tested in Accordance with AS1530 Part 7)*



REF IS1212 - IS8011si (FF)
15

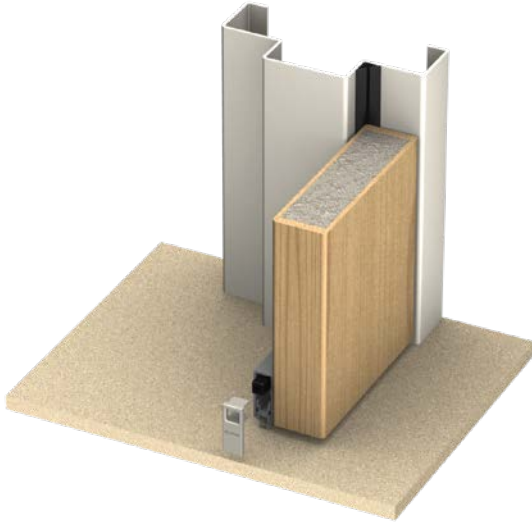

Door Thickness
37mm

REF IS7025si - IS8035si (SM)
16

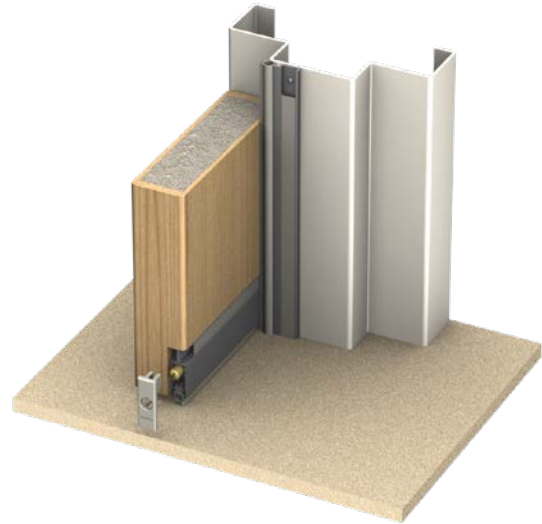

Door Thickness
37mm

REF KG1612BW - IS8010si
17

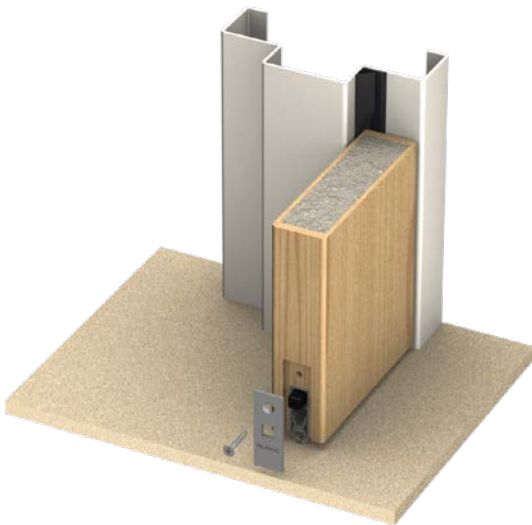

Door Thickness
37mm

REF IS7080si - IS8010si
18

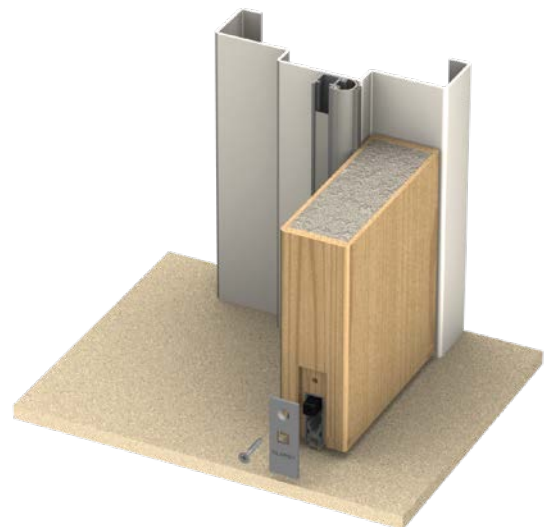

Door Thickness
47mm

Proprietary Fire Rated Doors *(Tested in Accordance with AS1530 Part 7)*



REF IS7080si - IS8090si (FF)
19

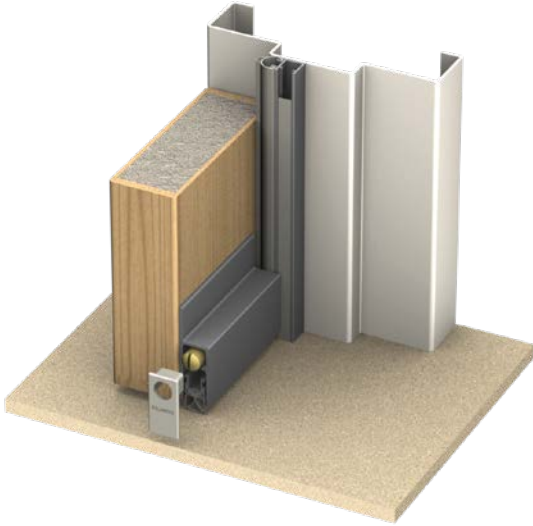

Door Thickness
47mm

REF IS7195si - IS8520si (FF)
20

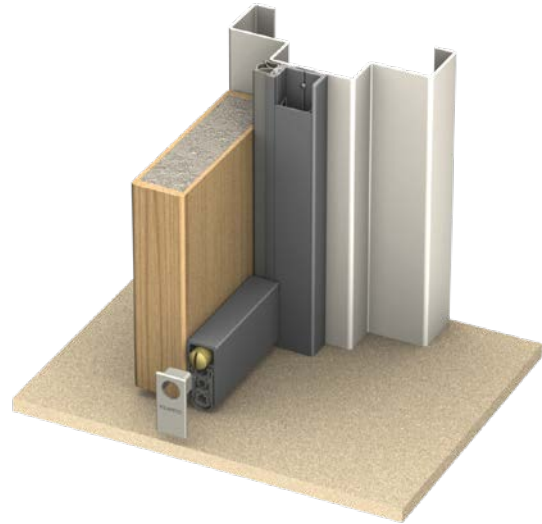

Door Thickness
47mm

REF IS1212 - FDMS-TP - IS8035si (SM)
21

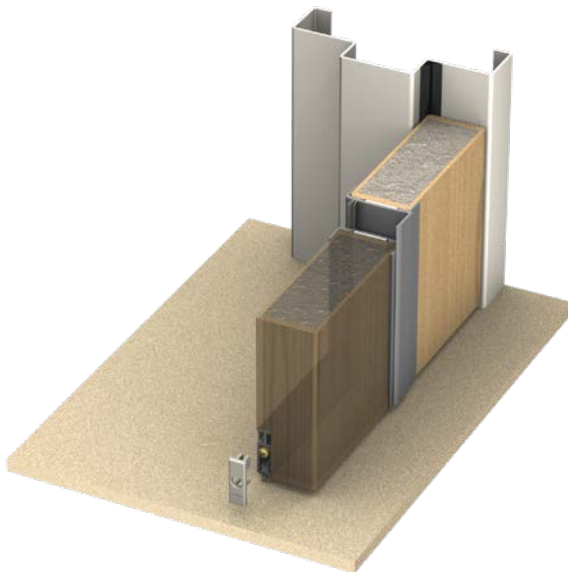

Door Thickness
47mm

REF IS7025si - FDMS-TP - IS8090si (SM)
22

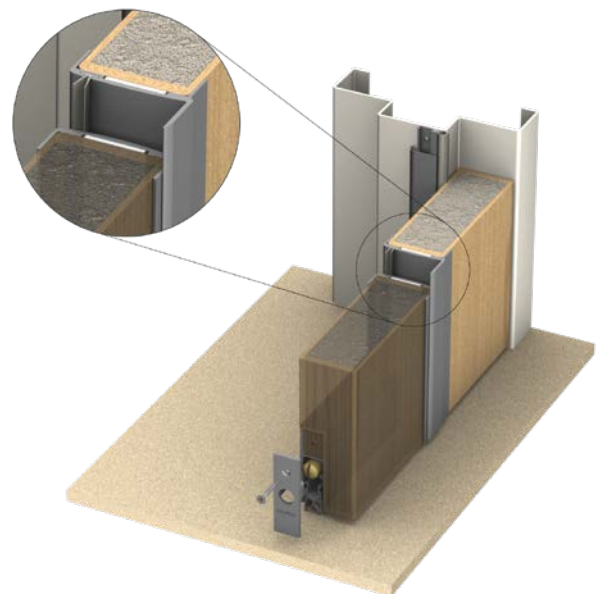

Door Thickness
47mm

Smoke Door Sealing Solutions

Proprietary Fire Rated Doors (Tested in Accordance with AS1530 Part 7)



REF KG1612BW - FDMS-TP - IS8010si

23

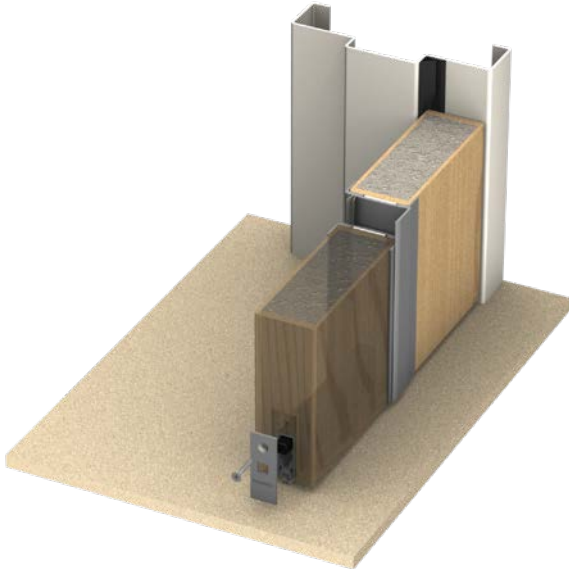

Door Thickness

47mm

Test Ref	Door Thickness	Config.	Perimeter Seal	Door Bottom Seal	Meeting Stile Seal	Specimen Configuration	Exposure Temp	Leakage Rate Correction	Leakage Rate Q (m³/h) at a pressure differential of:		
									10 Pa	25 Pa	50 Pa
15	37mm	Single	IS1212	IS8011si (FF)		Opening towards positive pressure (fire side)	Ambient	SRC	3	5	7
							Medium 200°C	SRC	7	10	13
							Medium 200°C > 30 min	SRC	14	22	31
16	37mm	Single	IS7025si	IS8035si (SM)		Opening away from positive pressure (fire side)	Ambient	SRC	2	3	4
							Medium 200°C	SRC	1	2	4
							Medium 200°C > 30 min	SRC	2	3	6
17	37mm	Single	KG1612BW	IS8010si		Opening towards positive pressure (fire side)	Ambient	SRC	3	5	7
							Medium 200°C	SRC	10	13	16
							Medium 200°C > 30 min	SRC	10	18	26
18	47mm	Single	IS7080si	IS8010si		Opening away from positive pressure (fire side)	Ambient	SRC	4	7	9
							Medium 200°C	SRC	2	4	7
							Medium 200°C > 30 min	SRC	3	5	8
19	47mm	Single	IS7080si	IS8090si (FF)		Opening away from positive pressure (fire side)	Ambient	SRC	3	5	7
							Medium 200°C	SRC	2	3	4
							Medium 200°C > 30 min	SRC	1	2	4
20	47mm	Single	IS7195si	IS8520si (FF)		Opening away from positive pressure (fire side)	Ambient	SRC	3	5	7
							Medium 200°C	SRC	1	3	5
							Medium 200°C > 30 min	SRC	1	3	5
21	47mm	Double	IS1212	IS8035si (SM)	FDMS-TP	Opening towards positive pressure (fire side)	Ambient	SRC	3	6	8
							Medium 200°C	SRC	1	2	4
							Medium 200°C > 30 min	SRC	1	4	6
22	47mm	Double	IS7025si	IS8090si (SM)	FDMS-TP	Opening towards positive pressure (fire side)	Ambient	SRC	4	8	12
							Medium 200°C	SRC	6	9	12
							Medium 200°C > 30 min	SRC	8	13	18
23	47mm	Double	KG1612BW	IS8010si	FDMS-TP	Opening towards positive pressure (fire side)	Ambient	SRC	6	10	14
							Medium 200°C	SRC	4	8	12
							Medium 200°C > 30 min	SRC	6	9	14

Specialty Doors (Tested in Accordance with AS1530 Part 7)



REF IS0511 - IS7061 x 2 - KP3504TF - IS4130
24

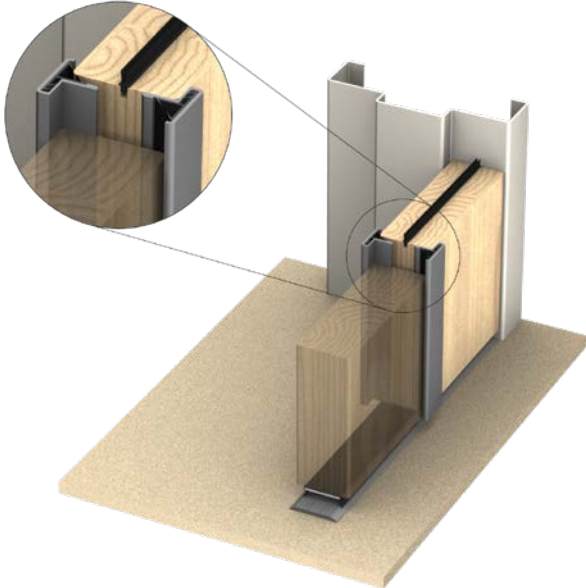

Door Thickness
38mm

REF ISSBE-01/08 (Besam System)
25 *Automatic door system

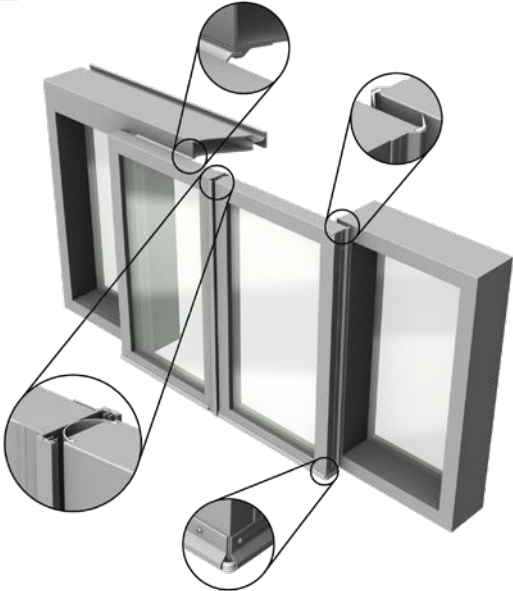

Door Thickness
nom. 40mm

REF ISSDA301 (Dorma System)
26 *Automatic door system

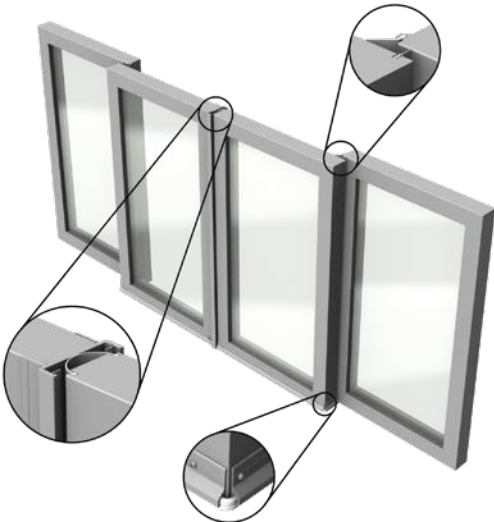

Door Thickness
nom. 40mm

REF IS7071si x 2 - IS5111si x 2 - IS4015
27 *System incorporates nominal 10mm laminated glass

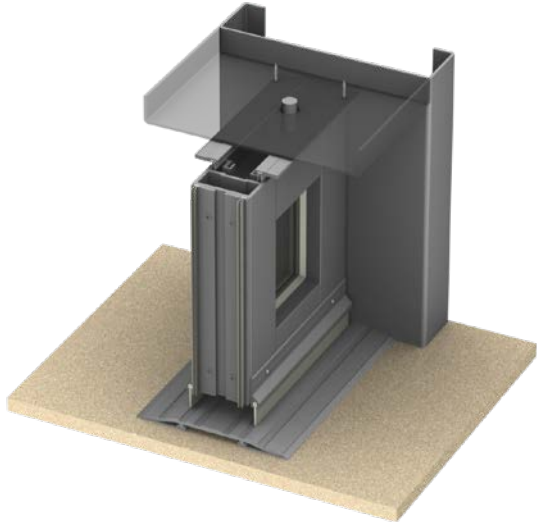

Door Thickness
nom. 45mm

Smoke Door Sealing Solutions

Specialty Doors (Tested in Accordance with AS1530 Part 7)



REF IS7071si x2 - IS5111si - IS4015
28 *System incorporates nominal 10mm laminated glass

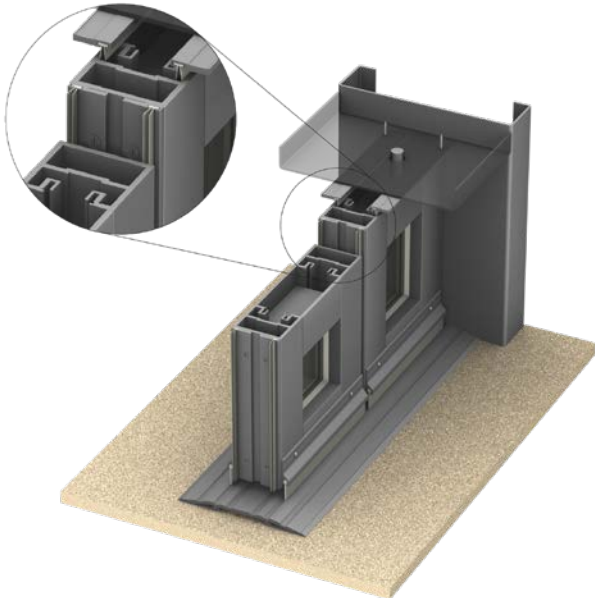

Door Thickness
 nom. 45mm

REF IS7080si-IS8020si-IS4015si
29

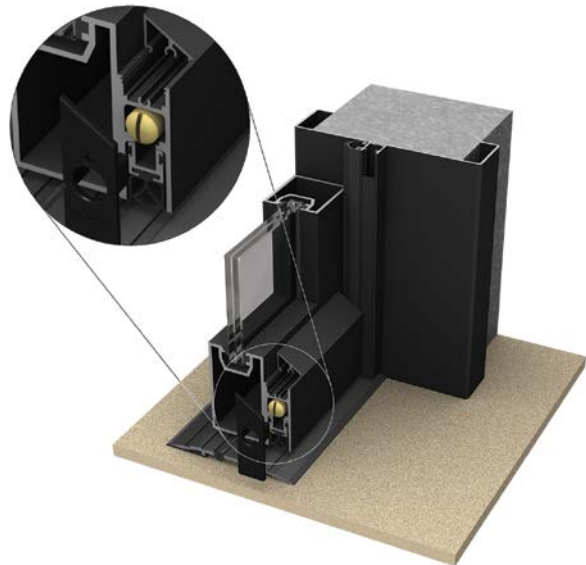

Door Thickness
 nom. 45mm

Test Ref	Door Type	Door Thickness	Config.	Perimeter Seal	Door Bottom Seal	Meeting Stile Seal	Threshold Plate	Specimen Configuration	Exposure Temp	Leakage Rate Correction	Leakage Rate Q (m ³ /h) at a pressure differential of:			
											10 Pa	25 Pa	50 Pa	
24	Specialty Timber Door	38mm	Double	IS0511 x 1 layer	KP3504TF	IS7061 x2 (Plain rebate)	IS4130	Opening towards positive pressure (fire side)	Ambient	SRC	7	10	14	
									Medium 200°C	SRC	2	3	4	
									Medium 200°C > 30 min	SRC	7	13	19	
25	Specialty Door -Besam		Single / Double					Opening towards positive pressure (fire side)	Medium 200°C	SRC	3	9	15	
									Medium 200°C > 30 min	SRC	7	12	18	
26	Specialty Door -Dorma		Single / Double					Opening towards positive pressure (fire side)	Medium 200°C	SRC	3	9	15	
									Medium 200°C > 30 min	SRC	2	7	13	
27	G James Aluminium Glazed Door	nom. 45mm (10mm laminate glass)	Double Action / Single Door	IS7071si x 2 layers		IS5111si (both sides of door bottom)	IS7071si x2 (Plain rebate)	IS4015	Opening towards positive pressure (fire side)	Ambient	SRC	5	8	11
									Medium 200°C > 30 min	SRC	1	2	3	
28	G James Aluminium Glazed Door	nom. 45mm (10mm laminate glass)	Double Action / Double Door	IS7071si x 2 layers		IS5111si (both sides of door bottom)	IS7071si x2 (Plain rebate)	IS4015	Opening towards positive pressure (fire side)	Ambient	SRC	6	9	12
										Medium 200°C > 30 min	SRC	2	4	6
29	G James Aluminium Glazed Door	nom. 45mm (10mm laminate glass)	Single Action / Single Door	IS7080si	IS8020si			IS4015	Opening towards positive pressure (fire side)	Ambient	SRC	2	3	4
										Medium 200°C	SRC	1	2	4
										Medium 200°C > 30 min	SRC	1	2	3

FIRE & SMOKE

Door Sealing Solutions



Fire & Smoke Sealing Systems Overview

Proprietary Fire Doors

Fire doors are a proprietary product. Despite similarities in manufacture and supply, each fire door must have its own test data outlining its field of application as mandated by the Building Code of Australia through the requirements set out in AS1905 Part 1.

For the Australian market, conventional fire doors have typically consisted of non-combustible core materials such as Vermiculite and mineral fibre, clad with plywood or MDF facings with concealed timber edge strips, allowing for easy installation into steel door frames. All items of door hardware, whether essential or non-essential are required to comply with the fire test requirements as governed by AS1905 Part 1, determined by fire resistance testing to AS1530 Part 4.

With architects looking more and more at form as well as function in today's commercial world, there are many options available for various types and applications of fire door hardware. However, it is very important to understand that door hardware is not generic. Fire door hardware must be tested to specific proprietary fire door assemblies. Essential seals (like intumescent) and non-essential door seals (including smoke and acoustic seals) are also required to undergo testing on proprietary fire-rated doorsets.

Fire Resistance Levels

The Building Code of Australia (BCA) uses Fire Resistance Levels (FRL) to nominate the required fire rating for different fire resistant barriers within a given building. These fire resistant barriers are created to limit a potential fire to a particular area (compartment) within a building, minimising the effects of fire on the building and its occupants.

Fire Resistance Level (FRL) is the classification period in minutes determined in accordance with Specification A2.3 of the BCA, for the following criteria—

- a) *structural adequacy*; and
- b) *integrity*; and
- c) *insulation*.

These are always expressed in this order.

As fire doors are not structural elements, they are not required to have a rating for Structural Adequacy. Similarly, the BCA also provides a generic non-exposed side temperature rise or insulation concession, allowing fire doors to only require 30 minutes insulation as part of their required FRL.

For example, a door opening in a non-load bearing partition wall with an FRL of -60/60 would require a '1 hour' fire door assembly (having a 1 hour Integrity rating), and would be expressed as: -/60/30.

This would represent a typical apartment entry door application.

Although we have tight controls for fire safety via our BCA and Fire Door Standard, it is important to realise that the minimum clearances stipulated for fire door assemblies in AS1905 Part 1, will not necessarily provide effective smoke and sound containment that many fire door applications may need. So called 'tight-fitting- fire doors with typical 3mm perimeter clearances and up to 10mm door bottom clearances, will allow excessive smoke and sound leakage unless otherwise sealed.

Kilargo has the sealing solutions.

The Solutions

Gaps around the edges of a fire door leaf are essential to enable effective operation of the door assembly. However, these small gaps do allow hot gases and toxic smoke to leak through, with potential for fire to spread from one compartment to the next. Kilargo provides sealing solutions that can effectively restrict the spread of hot gases and smoke across varying temperatures when applied to the perimeter of proprietary fire doors.

Kilargo **intumescent** seals are designed to 'intumesce' (swell) when subjected to heat - expanding to many times their original volume. This expansion provides a stable and resilient insulating barrier that restricts the spread of flames and hot smoke. These seals consist of an intumescent core material encapsulated in either a PVC casing or graphite skin which are fitted directly to door frames, door edges, or integrated into aluminium sections.

We also offer a range of combined **fire and smoke seals** that incorporate an intumescent core combined with smoke and acoustic fins. These seals are designed for all "phases" of smoke by providing a performance overlap, with the intumescent material being activated before the smoke-sealing fin reaches its degradation point.

Some door sealing solutions highlighted in this section are multi-functional, whereby one product offering, or a combination of products, provides efficient, cost-effective protection against fire, smoke, sound and energy leakage.

It is important to reiterate that Australian fire door designs are proprietary by nature. It is therefore a requirement that door seals and other items of essential hardware are tested in accordance with AS1530.4 - with each fire door manufacturer's door type - to ensure they do not compromise the assembly's established fire resistance level.

Intumescent Fire Seals for Proprietary Fire Doors



KP1504

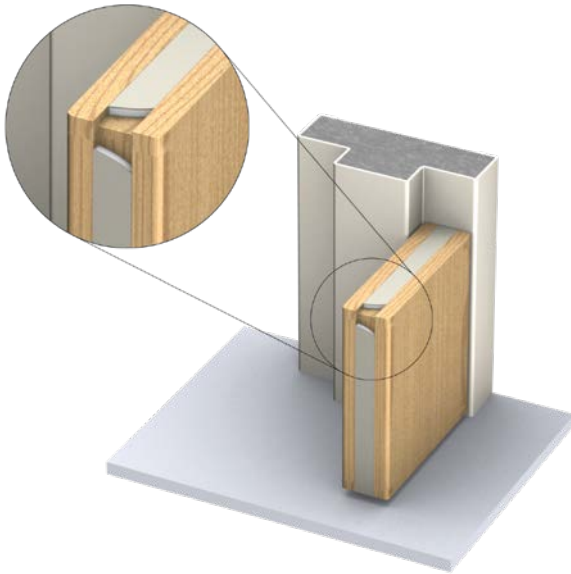

Door Thickness	FRL
37mm	-/30/30

KP2004

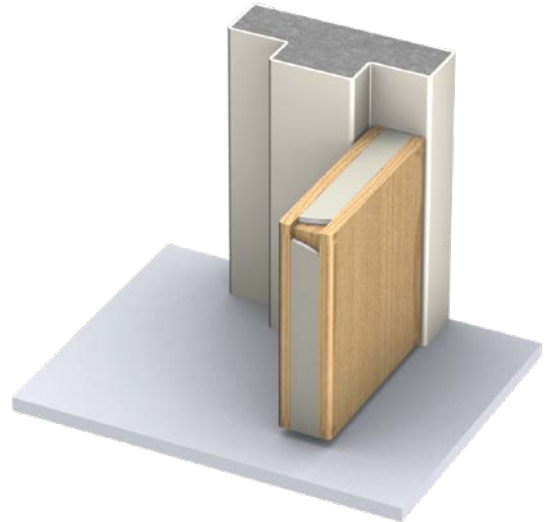

Door Thickness	FRL
37mm	-/60/30

KP2004 (timber frame)

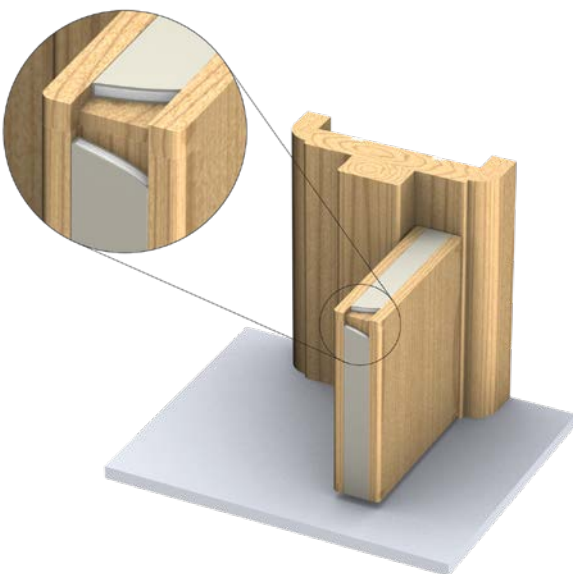

Door Thickness	FRL
37mm	-/60/30

KG4002

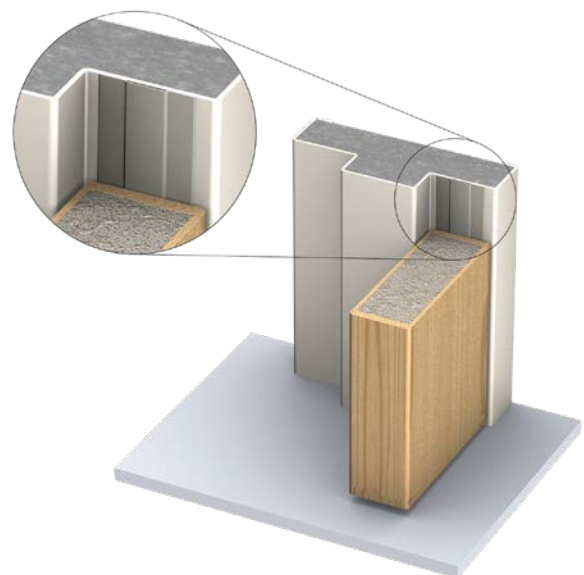

Door Thickness	FRL
37mm	-/120/30
47mm	-/120/30

Intumescent Fire Seals for Proprietary Fire Doors



FDMS-TP

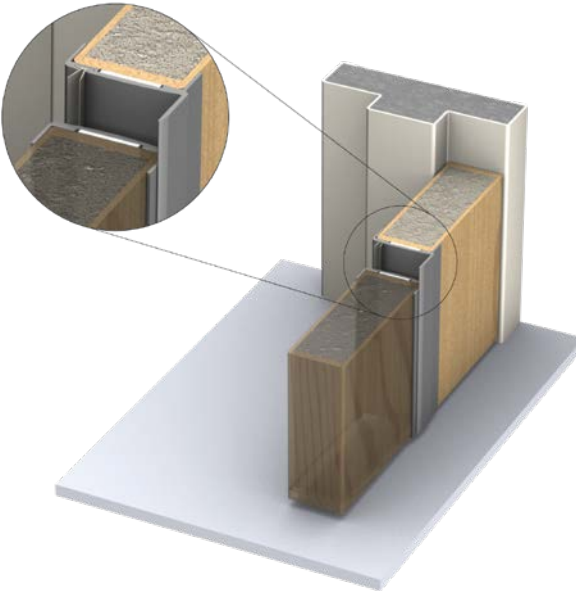

Door Thickness	FRL
47mm	-/120/30

FDMS-BB

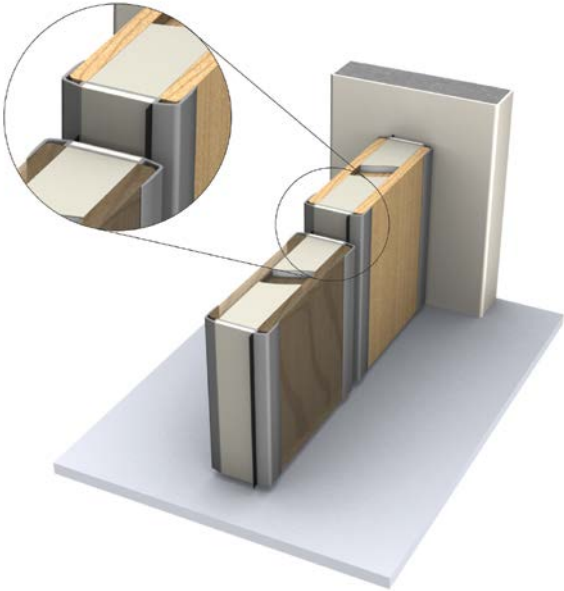

Door Thickness	FRL
47mm	-/120/30

Fire & Smoke Sealing Solutions

Intumescent Fire & Smoke Seals for Proprietary Fire Doors



KP1504 - IS1212 - IS8010si

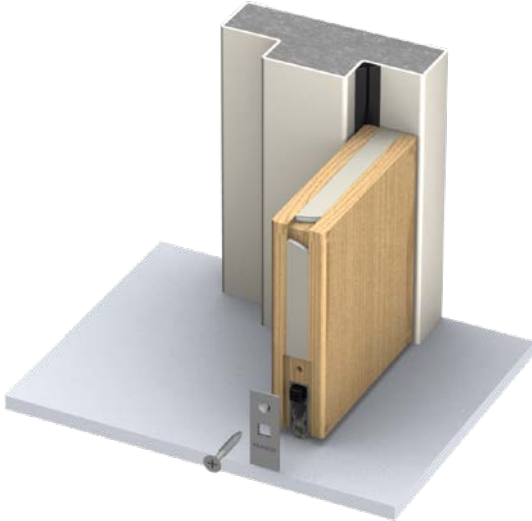

Door Thickness	FRL
37mm	-/30/30

KP2004TS - IS8010si

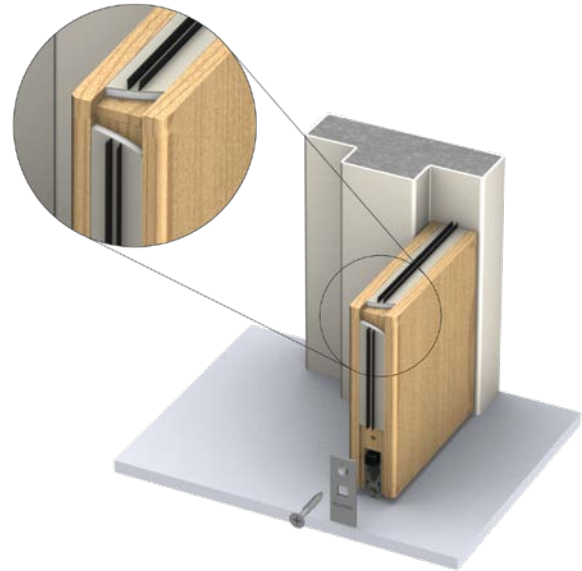

Door Thickness	FRL
37mm	-/60/30

KG1612BW - IS8011si

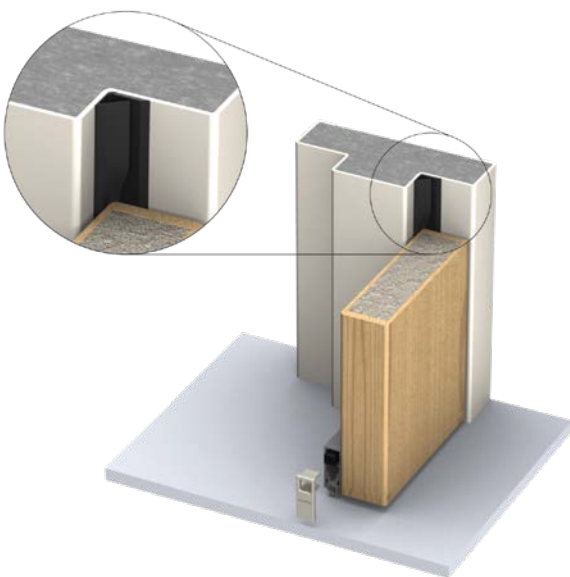

Door Thickness	FRL
37mm	-/120/30

KG2512BW - KP4204TF

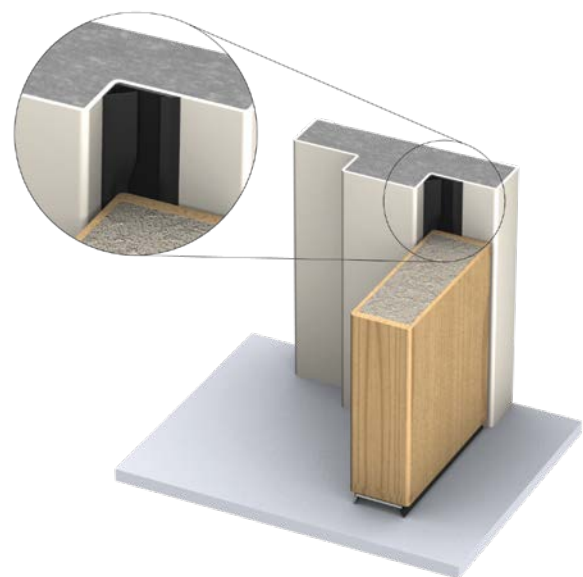

Door Thickness	FRL
47mm	-/120/30

Fire & Smoke Sealing Solutions

Intumescent Fire & Smoke Seals for Proprietary Fire Doors



KG1612BW - FDMS-TP - IS8010si

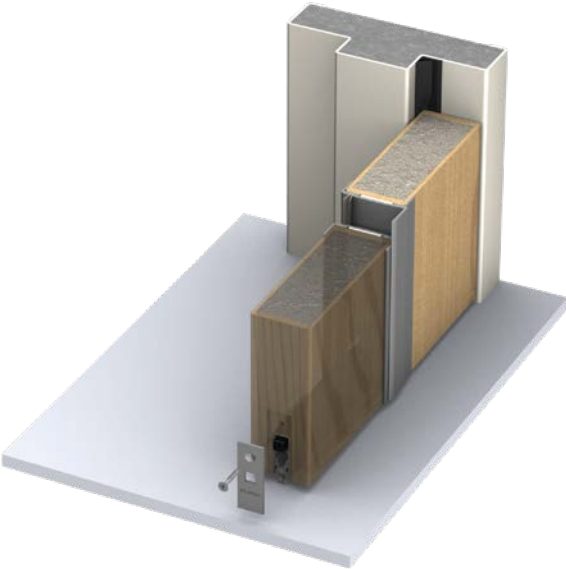

Door Thickness	FRL
47mm	-/120/30

FDMS-BB - FDMS-BB - KP3006

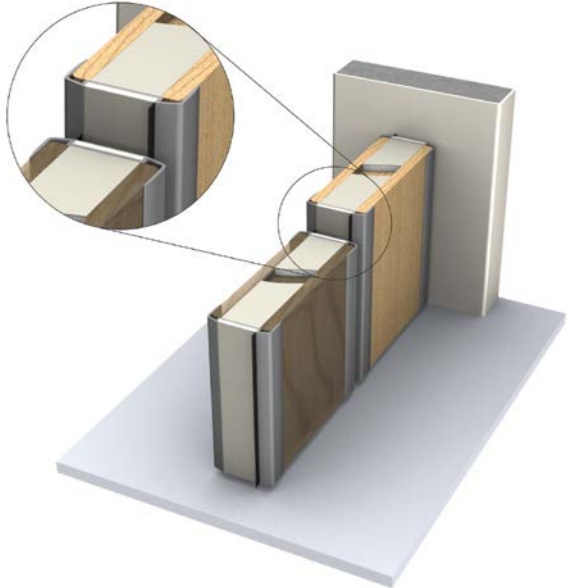

Door Thickness	FRL
47mm	-/120/30

Fire & Smoke Sealing Solutions

Smoke & Acoustic Seals for Proprietary Fire Doors



Fire & Smoke Sealing Solutions

IS1212 - IS8011si

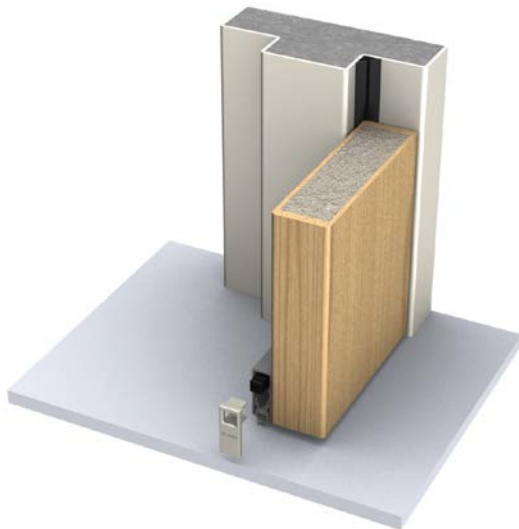

Door Thickness	FRL	Rw
37mm	-/120/30	30
47mm	-/120/30	31

IS7025si - IS8010si



Door Thickness	FRL	Rw
37mm	-/120/30	30
47mm	-/120/30	31

IS7080si - IS8090si

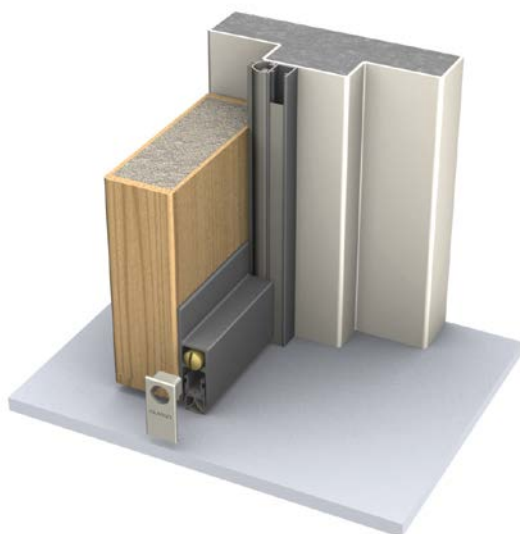

Door Thickness	FRL	Rw
47mm	-/120/30	31

IS7085si - IS8020si

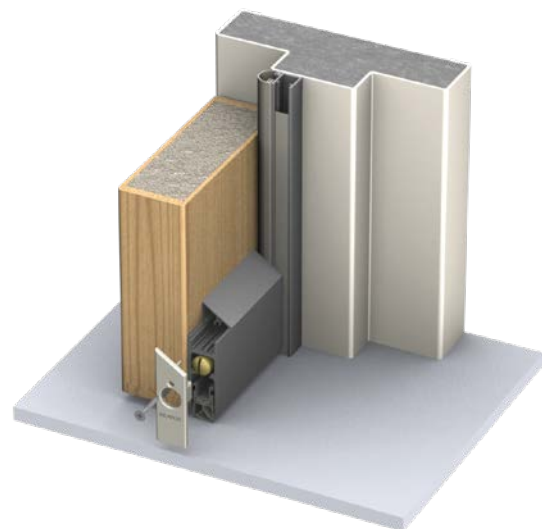

Door Thickness	FRL	Rw
47mm	-/120/30	31

Smoke & Acoustic Seals for Proprietary Fire Doors



IS7087si - IS8091si

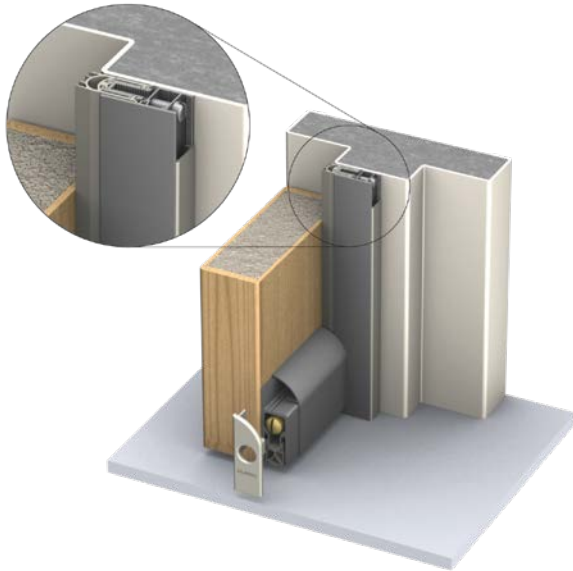

Door Thickness	FRL	Rw
47mm	-/120/30	31

IS1212 - FDMS-TP - IS8010si

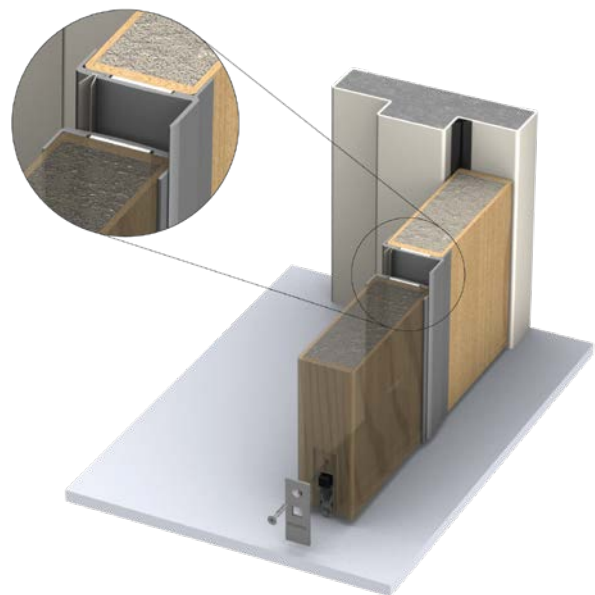

Door Thickness	FRL	Rw
47mm	-/120/30	31



Upgrading Non-Compliant Proprietary Fire Door Assemblies

The Kilargo range of upgrade solutions for non-compliant fire resistant doors can overcome frustrating and expensive problems for building owners, building contractors and essential service providers alike. In-situ fire resistant doors that would otherwise need new and expensive replacements, can now be salvaged.

This range includes:

- Seals that allow doors with excessive perimeter gaps (up to 6mm) to be easily upgraded
- Seals that allow the use of slim-line, non-standard fire door frame stops
- Seals that allow doors with excessive door bottom gaps (from 10mm up to 60mm) to be easily upgraded

These solutions provide fire ratings up to and including 2 hours and are approved for use on most proprietary fire doors, including:

- 'Mini' fire doors (nominal 35mm thickness)
- 'Maxi' fire doors (nominal 45mm thickness)

All products have been fire tested to AS1530.4 and comply with AS1905.1.

Regulatory Requirements

The use of fire door assemblies within buildings is regulated by the Building Code of Australia which references the Australian Standard AS1905.1: 2005 Components for the protection of opening in fire resistant walls. Part 1: Fire resistant doorsets.

This standard mandates and describes the critical aspects of a fire door assembly including its fire resistance level, attributes and characteristics of critical components, installation of the entire fire door assembly as well as identification and labelling requirements. Section 5.5 of AS1905.1 details the allowable clearances around side hung fire doors assemblies:

5.5 Clearances

5.5.1 General

The clearance dimensions required for fire-resistant doorsets shall be in accordance with this Clause **unless greater clearance dimensions have been demonstrated on a tested specimen.**

5.5.2 Sill and Door Finish

Clearances between the bottom of all door leaves and the floor shall be as follows.

- a) Between the leaf and the top of any floor covering not less than 3mm and not more than 10mm.
- b) Between the leaf and the top of the non-combustible sill
 - i. not more than 10mm where there is no combustible floor covering; and
 - ii. not more than 25mm where there is a combustible floor covering present.

5.5.3 Side-Hung Door, Leaf-to-Frame

Door leaves side-hung into rebated frames shall be installed to swing clear of the doorframe and shall have mean clearances, in the closed position, between the leaf and the head, and between the leaf and each side, of not more than 3mm.

Keeping within these tolerances sounds uncomplicated but in reality this can be very difficult due to numerous site conditions, out of square frame installations, building movement, variance in floor levels and finishes etc.

It is imperative that fire resistant door assemblies function correctly, and regular inspection and maintenance plays a crucial part in achieving this. Australian Standard **AS1851 Routine service of fire protection systems and equipment**, provides concise guidance on inspection, test, maintenance, survey and reporting requirements for hinged fire resistant door assemblies as well as providing recommendations on the frequency of these checks and inspections.

Where fire door clearances are found to be outside of the prescribed tolerances highlighted in AS1905 Part 1, Kilargo can offer the following range of performance tested upgrade solutions for most proprietary fire door assemblies.



KG4002

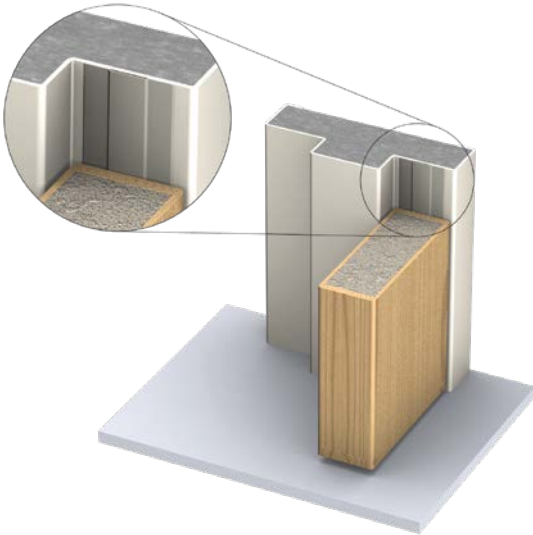

Door Thickness	FRL
37mm	up to 120 minutes
47mm	up to 120 minutes

- Allows Proprietary Fire Door Assemblies with non compliant perimeter gaps (where clearances exceed the 3mm as specified in AS1905 Part 1) to be upgraded.
- The KG4002 caters for door perimeter gaps of up to 6mm.

KG5102

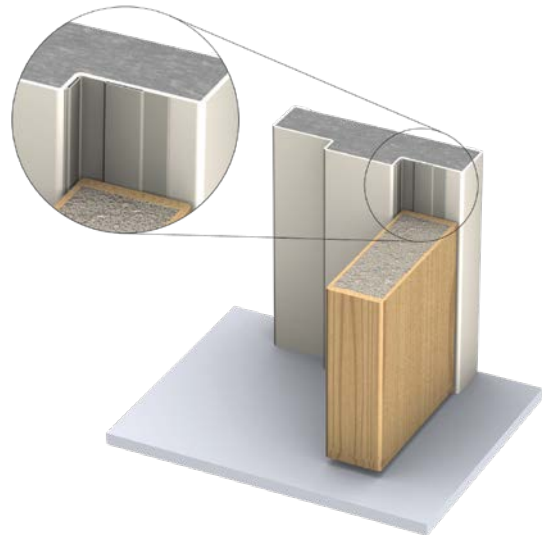

Door Thickness	FRL
37mm	up to 120 minutes
47mm	up to 120 minutes

- Allows for a cost effective and clean build-up of non-rated, backfilled steel frames with only 15mm stops, in lieu of the conventional 25mm stops required for Fire Doors.

FDBU20

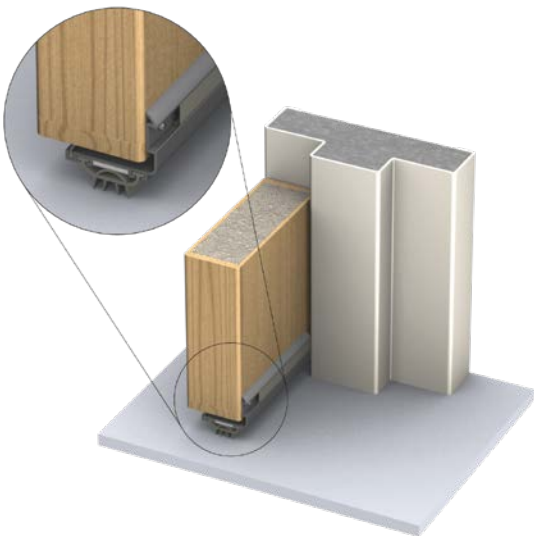

Door Thickness	FRL
37mm	up to 120 minutes
47mm	up to 120 minutes

- Allows upgrading of both nom. 37mm and 47mm thick Fire Doors, where door bottom gaps exceed the allowable 10mm (as per AS1905 Part 1).
- Can accommodate a door bottom clearance of up to and including a maximum 20mm.

FDBU60

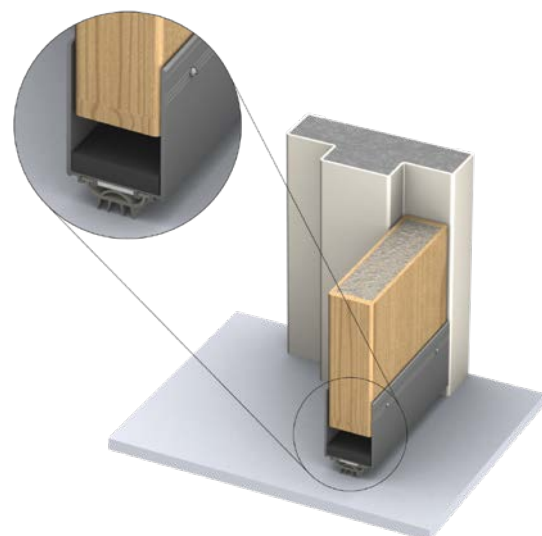

Door Thickness	FRL
37mm	up to 120 minutes
47mm	up to 120 minutes

- Allows upgrading of both nom. 37mm and 47mm thick Fire Doors, where door bottom gaps exceed the allowable 10mm (as per AS1905 Part 1).
- Can accommodate a door bottom clearance of up to and including a maximum 60mm.

IFD-D Door Kits for Proprietary Fire Door Assemblies

IFD-D



Door Thickness	FRL
37mm	up to 120 minutes
47mm	up to 120 minutes

- The damper units are slimline with an overall thickness of only 35mm allowing them to be flush-fitted within conventional 35 and 45mm nominal fire door leaves.
- The IFD-D intumescent fire damper kit comes complete with a pair of decorative face-fixed powder coated cover grilles that provide a clean / neat appearance, plus a tube of Kilargo fire-rated mastic.

Sizes

Standard door kit sizes:

- 300mm x 300mm
- 450mm x 450mm
- 600mm x 300mm
- 600mm x 600mm

Approvals

- AS1530/4 fire tests with proprietary fire doors providing up to 2 hours fire resistance.
- Complies with AS1905/1

Note: Please check with our Technical Department or the Fire Door Manufacturer for relevant test approvals and suitability for door type.



Kilargo

dormakaba Group

BUSHFIRE

Sealing Solutions for
Door Assemblies in
Bushfire Prone Areas



Bushfire Door Sealing Systems Overview

After the significant bushfires in Canberra in 2003, the Australian Standard relating to building in bushfire prone areas was revised and a new Australian Standard (AS 3959) was drafted.

In the wake of the devastating Victorian bushfires in February 2009, this Standard was extensively reviewed, providing clearer guidance on the construction requirements for buildings in bushfire prone areas. The aim of the new building standard is to improve the ability of buildings to withstand a bushfire attack. This will provide greater protection for any occupants who may be sheltering in dwellings until the fire front passes, also increasing the chances of a building surviving a bushfire attack.

A great deal of scientific modelling has gone into the new building Standard AS3959-2009 (Construction of buildings in bushfire-prone areas). The chart below highlights the control data, which is defined as a Bushfire Attack Level (BAL). This determines the type of building construction required in bushfire prone areas in order to improve their resistance to bushfire attack from burning embers, radiant heat, or flames generated by a bushfire.

The BAL takes into consideration a number of factors including the Fire Danger Index, the slope of the land, types of surrounding vegetation and its proximity to any building.

The Fire Danger Index is a measure of the associated fire weather and the probability of a bushfire starting. It also includes its rate of spread, intensity and difficulty of suppression according to various combinations of temperature, relative humidity, wind speed and estimate of fuel state, all of which is influenced by daily rainfall and the time elapsed since the last rainfall.

Bushfire Attack Level (BAL)	Description of predicted bushfire attack and levels of exposure
BAL-LOW	The risk is considered to be VERY LOW. There is insufficient risk to warrant specific construction requirements.
BAL-12.5	The risk is considered to be LOW. There is a risk of ember attack.
BAL-19	The risk is considered to be MODERATE. There is a risk of ember attack and burning debris ignited by wind-borne embers and a likelihood of exposure to radiant heat.
BAL-29	The risk is considered to be HIGH. There is an increased risk of ember attack and burning debris ignited by wind-borne embers and a likelihood of exposure to an increased level of radiant heat.
BAL-40	The risk is considered to be VERY HIGH. There is a much increased risk of ember attack and burning debris ignited by wind-borne embers, a likelihood of exposure to a high level of radiant heat and some likelihood of direct exposure to flames from the fire front.
BAL-FZ	The risk is considered to be EXTREME. There is an extremely high risk of ember attack and burning debris ignited by wind-borne embers, and a likelihood of exposure to an extreme level of radiant heat and direct exposure to flames from the fire front.

Bushfire Protection Levels / Minimum Seal Requirements as per AS3959 BAL Classifications

BAL (Bushfire Attack Level)	Vehicle Access Doors (Garage Doors)	Sliding Doors	Side-Hung External Doors, incl. French Doors, Panel-fold & Bi-fold Doors
BAL-LOW	AS3959 does not provide construction requirements for buildings assessed in bushfire-prone areas in accordance with Section 2 as being BAL-LOW.		
BAL-12.5	Panel-lift, tilt doors or side-hung doors shall be fitted with suitable weather strips, draught excluders, draught seals or guide tracks, as appropriate to the door type, with a maximum gap no greater than 3mm.	Sliding doors shall be tight-fitting in the frames and comply with AS3959 Clause 5.5.4	Doors shall be tight-fitting to the door frame and comply with AS3959 Clause 5.5.3. Weather strips, draught excluders or draught seals shall be installed at the base of side-hung external doors.
	Roller Doors shall have guide tracks with a maximum gap no greater than 3mm and shall be fitted with a nylon brush that is in contact with the door.		
BAL-19	Panel-lift, tilt doors or side-hung doors shall be fitted with suitable weather strips, draught excluders, draught seals or guide tracks, as appropriate to the door type, with a maximum gap no greater than 3mm.	Sliding doors shall be tight-fitting in the frames and comply with AS3959 Clause 6.5.4	Doors shall be tight-fitting to the door frame and comply with AS3959 Clause 6.5.3. Weather strips, draught excluders or draught seals shall be installed at the base of side-hung external doors.
	Roller Doors shall have guide tracks with a maximum gap no greater than 3mm and shall be fitted with a nylon brush that is in contact with the door.		
BAL-29	Panel-lift, tilt doors or side-hung doors shall be fitted with suitable weather strips, draught excluders, draught seals or guide tracks, as appropriate to the door type, with a maximum gap no greater than 3mm.	Sliding doors shall be tight-fitting in the frames and comply with AS3959 Clause 7.5.4	Doors shall be tight-fitting to the door frame and comply with AS3959 Clause 7.5.3. Weather strips, draught excluders or draught seals shall be installed at the base of side-hung external doors.
	Roller Doors shall have guide tracks with a maximum gap no greater than 3mm and shall be fitted with a nylon brush that is in contact with the door.		
BAL-40	Panel-lift, tilt doors or side-hung doors shall be fitted with suitable weather strips, draught excluders, draught seals or guide tracks, as appropriate to the door type, with a maximum gap no greater than 3mm.	Sliding doors shall be tight-fitting in the frames. Seals shall be installed to stiles, head and sills or thresholds, and shall be manufactured from silicone rubber.	Doors shall be tight-fitting to the door frame and comply with AS3959 Clause 8.5.3. For side-hung external doors, weather excluders or draught seals shall be installed at the base. Seals to stiles, head and sills or thresholds shall be manufactured from silicone rubber.
	Roller Doors shall have guide tracks with a maximum gap no greater than 3mm and shall be fitted with a nylon brush that is in contact with the door.		
BAL-FZ	Panel-lift, tilt doors or side-hung doors shall be fitted with suitable weather strips, draught excluders, draught seals or guide tracks, as appropriate to the door type, with a maximum gap no greater than 3mm.	All sliding doors shall be tight-fitting in the frame. Sliding door systems shall have an FRL of at least -/30/-, or comply with AS1530.8.2	Side-hung external doors, including French doors, panel-fold and bi-fold doors, shall have an FRL of at least -/30/-, or comply with AS1530.8.2
	Roller Doors shall have guide tracks with a maximum gap no greater than 3mm and shall be fitted with a nylon brush that is in contact with the door.		Doors shall be tight-fitting to the door frame, compliant with AS3959 Clause 9.5.3. Weather strips, draught excluders or draught seals shall be installed at the base of side-hung external doors.
			Seals shall not compromise the FRL or the performance achieved in AS1530 Part 4.

Note: The following solutions are given in good faith as guidance for varying applications in bushfire prone areas. Please consult the latest version of AS3959 for your specific compliance requirements under this Standard.

Bushfire Attack Level: BAL 12.5 - 29



IS5111si - IS3070si

External Aluminium Sliding Door

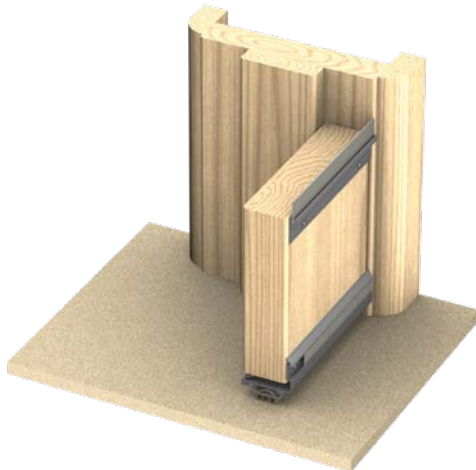

Door Thickness

Minimum 35mm thick solid core door

- This sealing combination is compliant with AS3959 as a suitable sealing solution for side-hung external doors in bush-fire risk areas.
- The door should be made from a non-combustible material (or otherwise compliant with the relevant BAL Standard clause) and be tight-fitting in its frame.
- Door frames shall be constructed from metal or a bush-fire resistant timber.

IS5120 - IS3021si

Panel Lift Garage Door

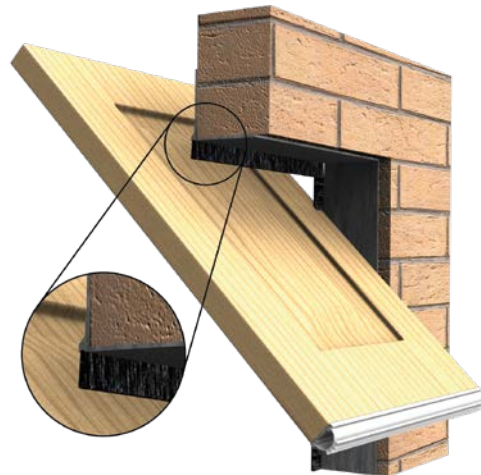

- This sealing combination is compliant with AS3959 as a suitable sealing solution for tilt-panel vehicle access doors (garage doors).
- The door should be made from a non-combustible material, bushfire-resistant timber or have a minimum 6mm fibre-cement sheet applied to the door material. The maximum gap around the door perimeter can be no greater than 3mm.

IS5110B - IS1006si

Side-hung External Bi-Fold Door

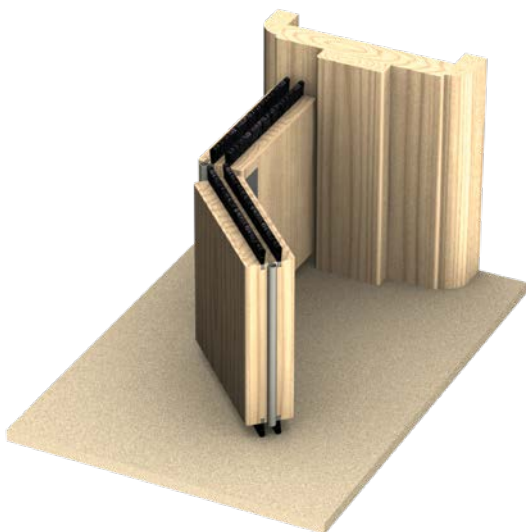

Door Thickness

Minimum 35mm thick solid core door

- This sealing combination is compliant with AS3959 as a suitable sealing solution for side-hung external bi-fold doors in bush-fire risk areas with a Bushfire Attack Level 29.
- The door should be made from a non-combustible material (or otherwise compliant with the relevant Standard AS3959 Part 7.5.3) and be tight-fitting in its frame.
- Door frames shall be constructed from metal or a bush-fire resisting timber. Where doors incorporate glazing, the glazing shall be toughened glass minimum 6mm thick.
- *Shutters or appropriate screens may also be required as per the relevant Standard requirements.*

Bushfire Attack Level: BAL 40



IS5161Hsi - IS3021si

Panel Lift Garage Door

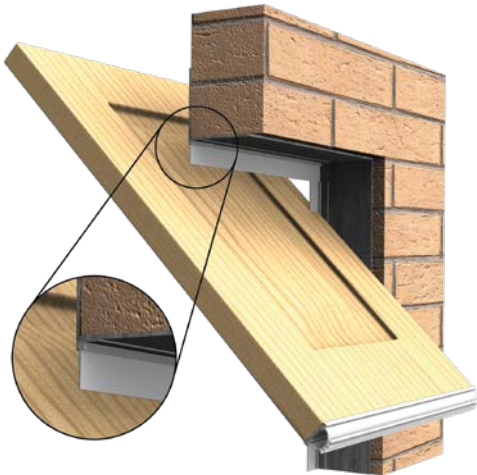

- This sealing combination is compliant with AS3959 as a suitable sealing solution for tilt-panel vehicle access doors (garage doors) with a Bush-fire Attack Level of 40.
- The door should be made from a non-combustible material. The maximum gap around the door perimeter can be no greater than 3mm.

IS5111si

External Sliding Door

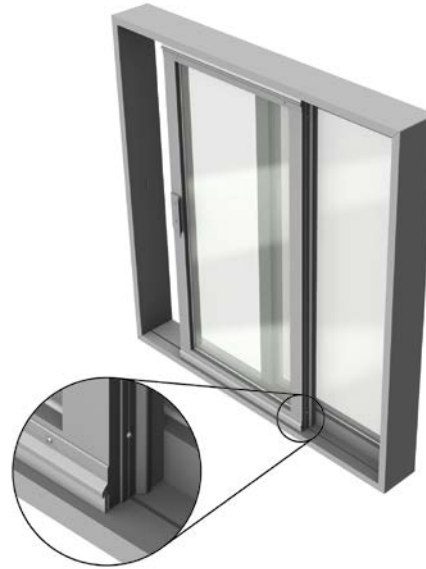

- This sealing combination is compliant with AS3959 as a suitable sealing solution for an external sliding door in a bush-fire risk area with a Bushfire Attack Level of 40.
- The door should be constructed so that it complies with AS3959 Part 8.5.4) and be tight-fitting in its frame.
- Both the sliding door frame and framing surrounding any glazing shall be metal. Where sliding doors incorporate any glazing, the glazing shall be toughened glass of minimum 6mm thick. Both the fixed and openable portions of the doors shall also be fitted with screens that comply with Clause 8.5.1A.
- The seals fitted to stiles, head and thresholds shall be manufactured from silicone or a material with a flammability index no greater than 5.

Bushfire Attack Level: BAL FZ



IS5176Asi - IS3020si

Roller Garage Door



- This sealing combination is compliant with AS3959 as a suitable sealing solution for metal roller vehicle access doors (garage doors) with a Bush-fire Attack Level FZ or less, providing effective resistance to ember attack.
- The door should be made from a non-combustible material and have roller guide tracks with a maximum gap no greater than 3mm.
- *Where the vehicle access garage is attached to the building, the requirements of AS3959 Clause 3.2.2(b) shall apply.*

IS1212 - IS5111si

Hinged Entry Door - Fire Rated

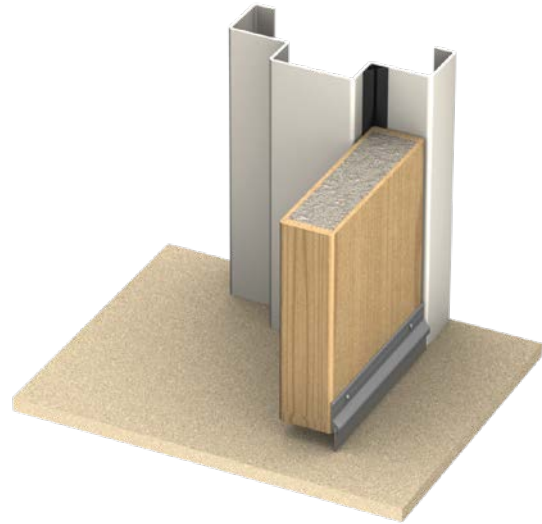

- This sealing combination is compliant with AS3959 as a suitable sealing solution for side-hung external doors in bush-fire risk areas with a Bushfire Attack Level FZ classification or less.
- The door shall have an FRL of at least -/30/-, or comply with AS1530.8.2 (when tested from the outside).
- Doors shall be tight-fitting to the frame and the seals shall not compromise the FRL of the door assembly performance achieved under AS1530.4.

WEATHER & ENERGY

Door Sealing Solutions



Weather & Energy Door Sealing Systems Overview

One of the simplest and most effective measures that home and business owners can take to reduce energy costs is to ensure that their building is well sealed.

Wind drafts, hot air and water entering a building can all create problems in the local living and working environment, as well as increasing energy usage; Kilargo's weather seals and weather strips make sure you keep the elements at bay and maintain control over your air temperatures.

How Do They Work?

Drafts flowing in through unsealed gaps in doors can disturb the living and working environment, with unwanted temperature imbalances.

Our weather seals and weather strips can be fitted to external door openings, to provide a physical barrier of insulation to unwanted air flows. They also protect a building from other undesirable environmental intrusions, such as rain, snow, hail or any other outdoor disturbances. This boosts comfort levels within any building.

How Do Weather Seals Save Energy Costs?

Energy savings result from the increased control over room temperature that comes from using weather seals.

You can stabilise air temperature and boost energy efficiency in air-conditioned or heated environments by regulating the appropriate temperature in any given room or living space; it will not be disturbed by external air flows. This can lead to significant savings over time.

Small Changes with Big Results

Making some small changes in your property can yield big results. Our weather seals couldn't be easier to use: simply fit them once and let them work to maintain a stable and comfortable environment, regardless of tropical storms, desert winds or hail showers.

Building Regulations & Associated Standards

Building regulations exist to ensure the safety and comfort of building users. In Australia's States and Territories, this is regulated via the provisions outlined in the Building Code of Australia (BCA).

The BCA recognises the need to reduce greenhouse gases and use energy in a more sustainable manner. It includes several sections directly relating to the Conservation of Energy and Weather Exclusion.

Section J Part J3.4.c provides guidance on energy-efficiency measures – and specifically the draft-proofing treatment for doors that form part of a building envelope or a conditioned space or public area in climate zones 4, 5, 6, 7 and 8.

It should be noted that the BCA sets out specific guidelines for energy efficiency in buildings – however, large climatic variances mean that Australian States and Territories apply their own Building Control Acts. These frequently specify regional energy efficiency schemes and requirements, so please check with your local regulatory authority about regulations for your location.

Energy Efficiency & Sustainability

Commercial buildings are responsible for approximately 10% of Australia's greenhouse gas emissions. Building owners, occupiers and facility managers can all benefit from improving their energy efficiency.

Enhancing the sustainability of commercial buildings can deliver savings on energy and building maintenance costs, increase building value and foster more engaged workers.

The rapid rise in energy costs and our increased focus on reducing energy consumption has prompted a review of how we heat and cool buildings. A range of methods are now used in the design and construction of buildings to conserve energy and facilitate its sustainable use.

One of the most simple and effective solutions is to install draft seals to doors of air-conditioned environments. These seals provide a simple infiltration barrier to hot and cool air, and the latent energy it contains. They can immediately increase comfort levels and assist with the control of cold drafts or rain infiltration.

Timber and Aluminium Hinged Doors



Single action Timber and Aluminium hinged doors can be effectively sealed using silicone perimeter seals, door bottom seals & automatic door bottom seals. Examples include the selection below.



IS1212 - IS3022si - IS4130

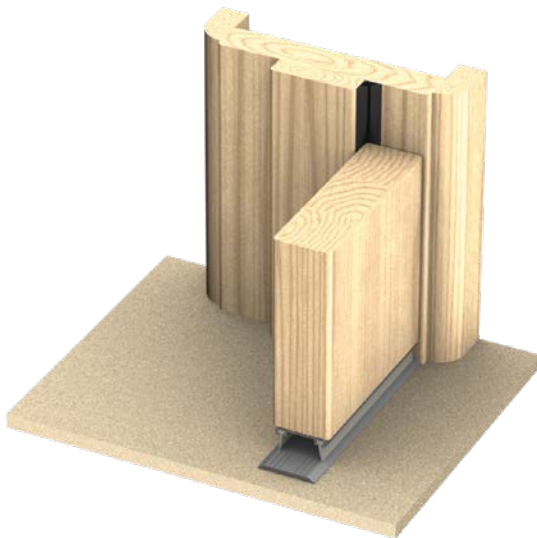

IS7025si - IS3100si

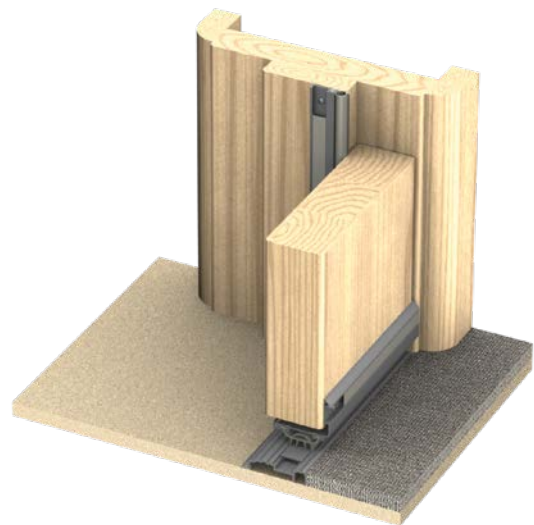

Timber and Aluminium Hinged Doors



IS7110si - IS7060si - IS3100si

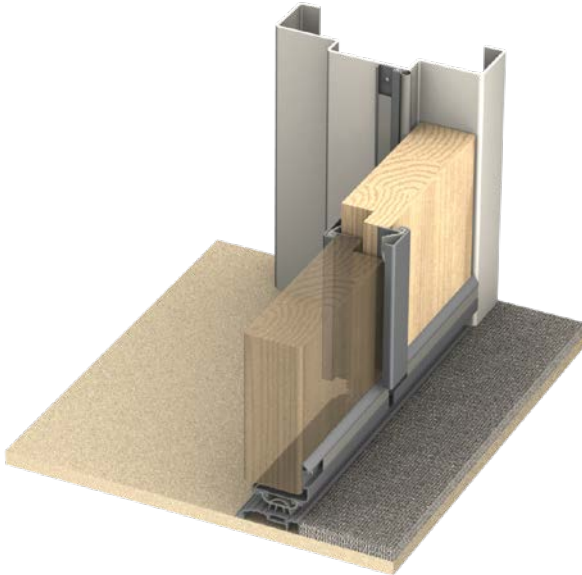

IS1006si - IS1006si - IS3080si

Outward Opening Door

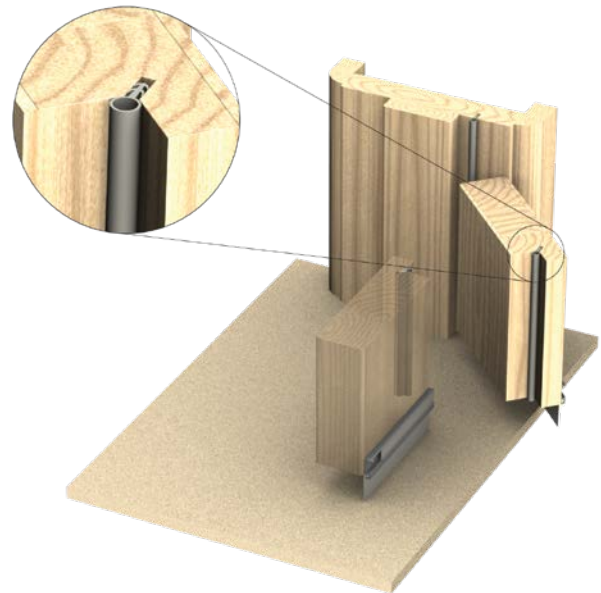

IS7080si - IS5111si - IS4070

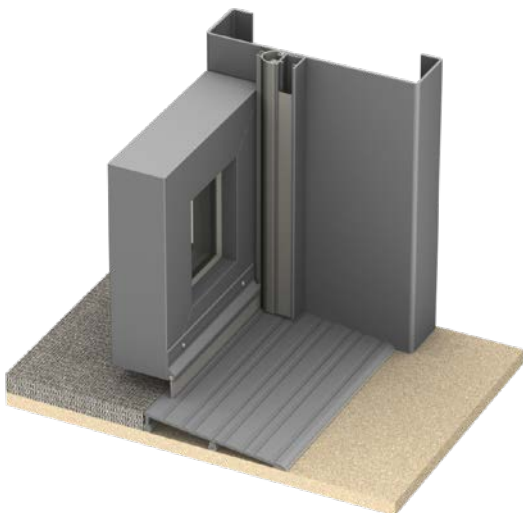

IS7080si - IS8020si - IS4010

(Black anodised shown)

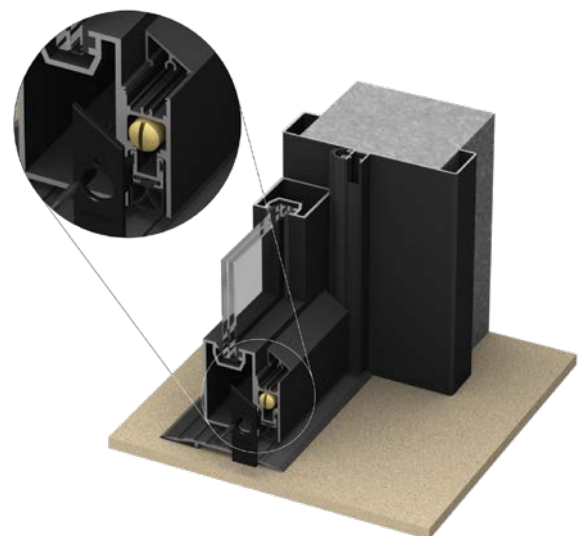

Timber, Aluminium and Glass Pivot Doors



Pivot door systems, whether single or double action, can be effectively sealed using nylon brush or silicone finned type, sweep-action seals. Examples include the selection below.



IS5110B - IS5110

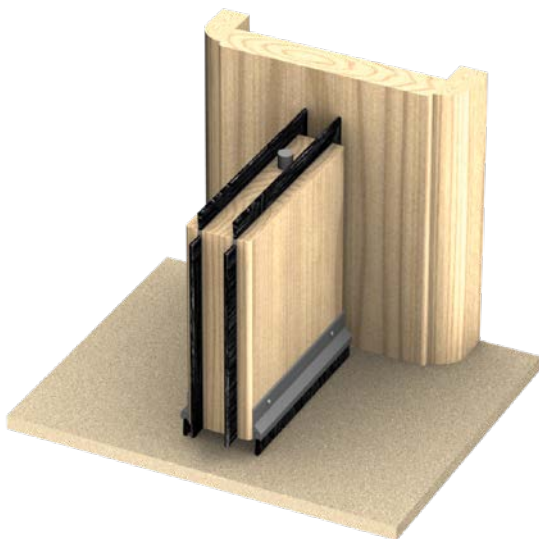

IS7350si - IS7355si - IS5111si

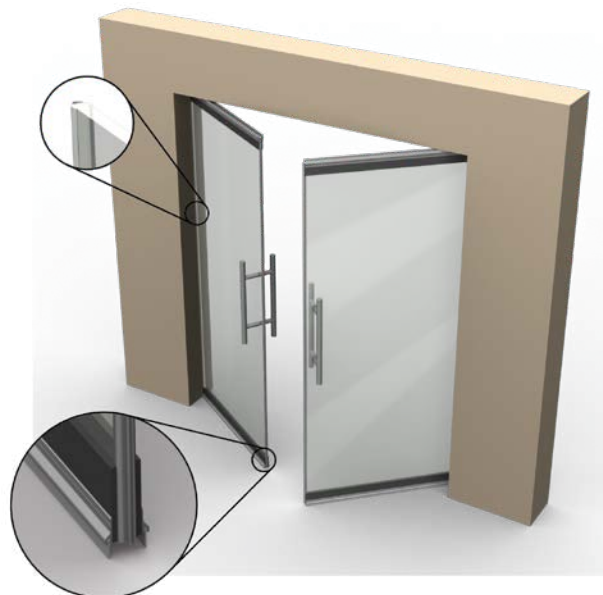

Timber, Aluminium and Glass Pivot Doors



IS7071si - IS7071si - IS3022si - IS4010

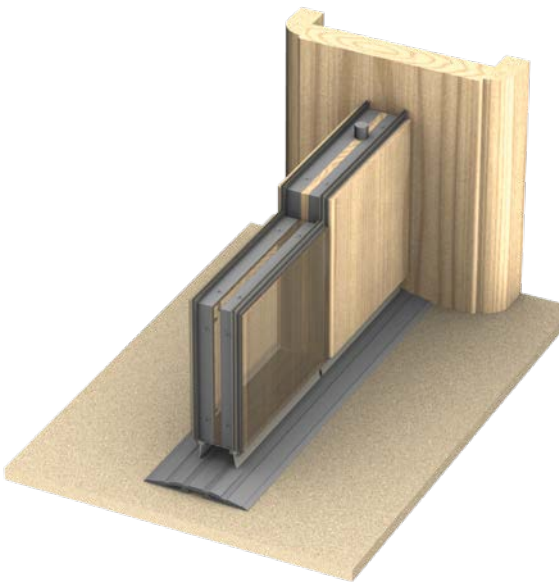

IS0602si - IS7071si - IS5111si

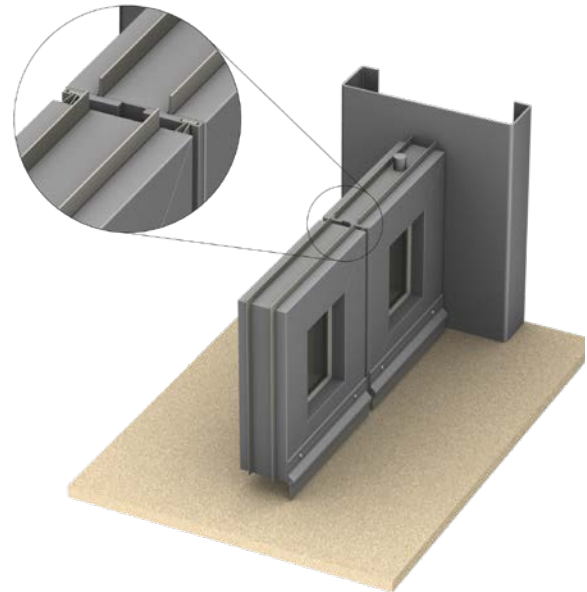

Timber, Aluminium and Glass Sliding Doors



Due to the lateral movement of sliding doors, there are limited sealing elements that can be utilised for these door configurations. Sweep-action seals, whether nylon brush filaments or soft silicone seals, provide the best solution. More traditional compression type seals are ineffective for the top and bottom stiles, plus the trailing edge of sliding doors, but can also be effective leading edge or meeting stile solutions (for double doors).



IS5110 - IS5115B

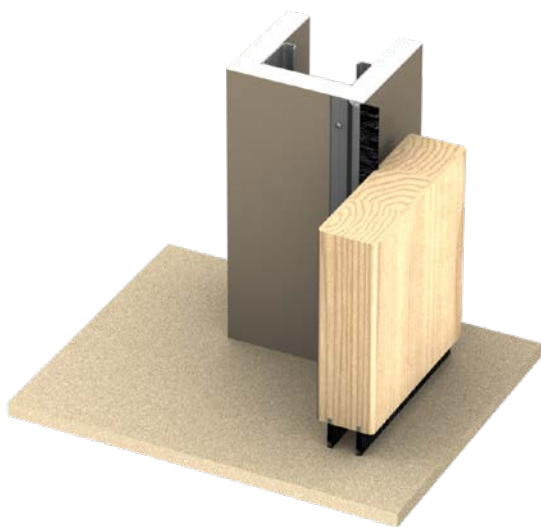

IS3017si - IS5110

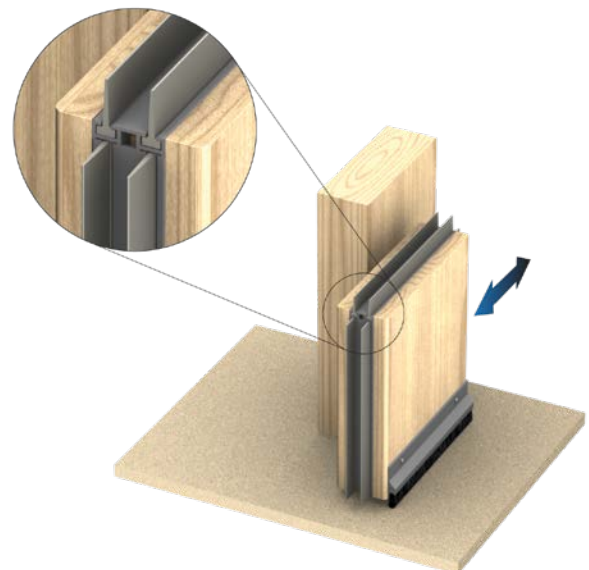

Timber, Aluminium and Glass Sliding Doors



IS5110 - IS5115 - IS5115

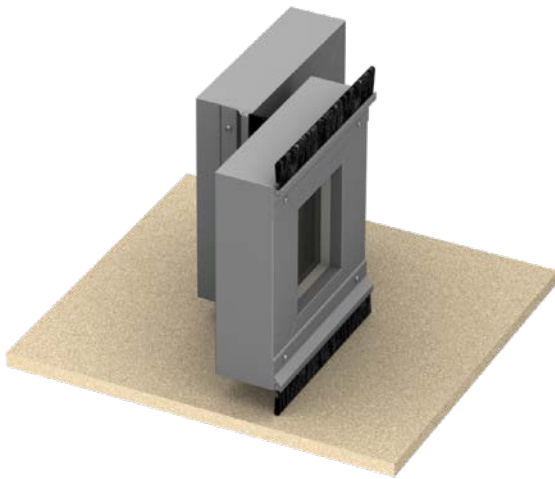

IS7300si

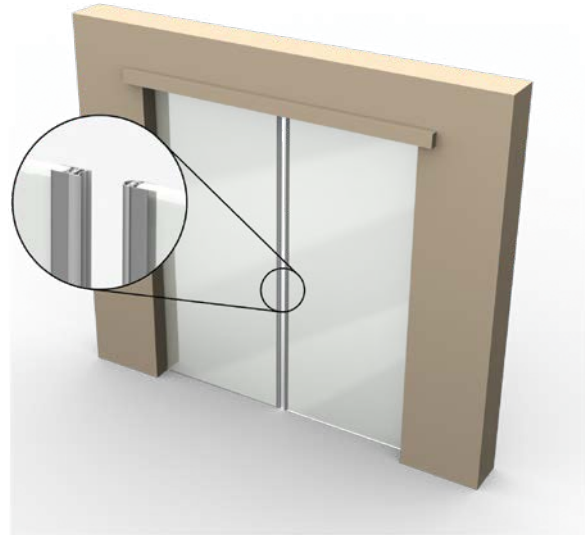

IS5111si

External Sliding Door



Timber Bi-Fold Doors



Timber bi-fold door systems are a popular option to sliding doors within buildings and where internal spaces meet the outside environment. To effectively seal against weather and air infiltration, or simply as a means of providing privacy between spaces, Kilargo has a number of retrofit sealing options. When combining compression type seals with sweep-action seals, an inexpensive, efficient solution can be achieved.

With the ability for bi-fold doors to tightly compress within their frames, these door sealing combinations do provide excellent weather and air infiltration resistance, improving energy efficiency and noise resistance, whilst also providing resistance to bushfire attack (*see Bushfire Sealing Solutions for Door Assemblies in Bushfire Prone Areas*).



IS5111si - IS1006si - IS5111si

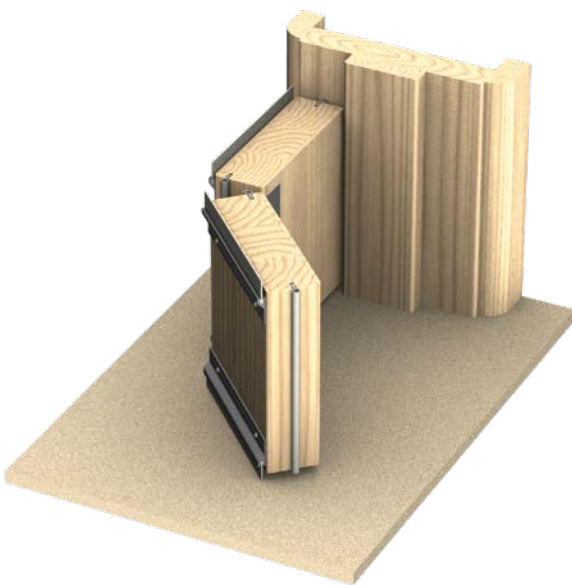

IS5110B - IS1006si

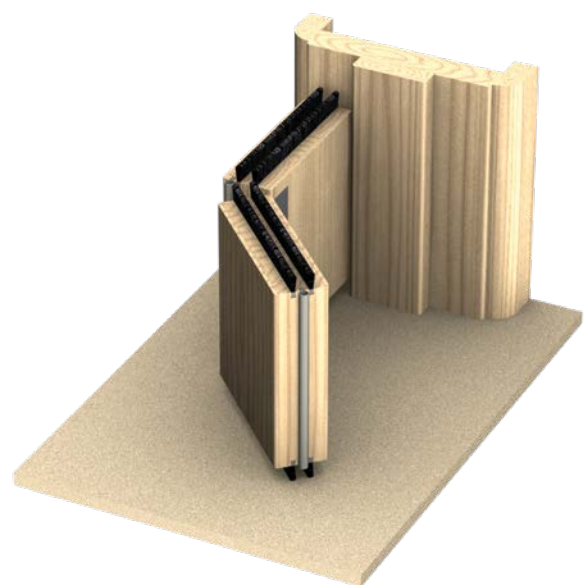

Garage Doors



To effectively seal roller, panel-lift and sectional garage doors, Kilargo offer a range of nylon brush seals, and soft silicone blade seals, housed in various configurations of aluminium sections. When properly installed, these seals close the gaps around the door perimeter, sealing against weather, draughts, dust and pests. They also provide resistance to bushfire attack (see *Bushfire Sealing Solutions for Door Assemblies in Bushfire Prone Areas*).



IS5175A - IS3020si

Roller Door

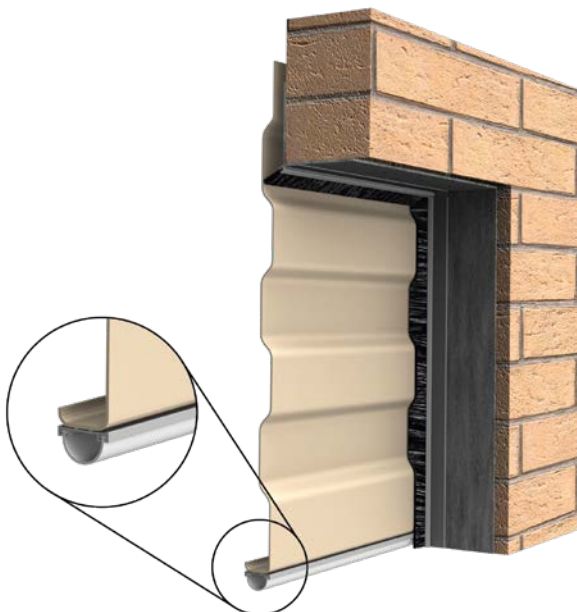

IS5120 - IS3021si

Panel Lift Door

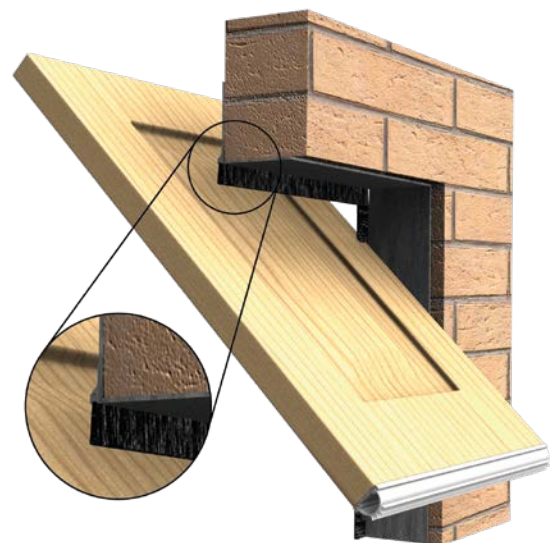

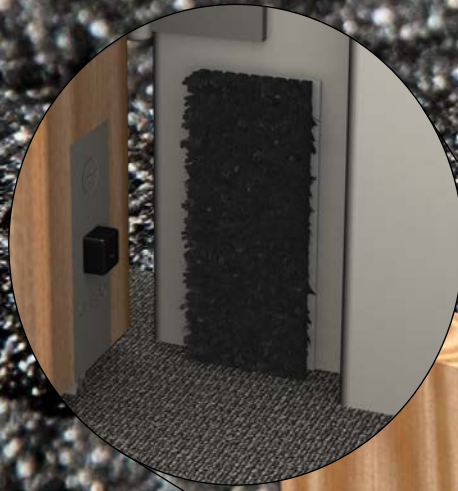

Adhesive Acoustic Corner Pads for Improved Sound Control...

Kilargo's IS8AP70 corner pads provide the ideal solution for door applications where improved sound attenuation is required.

Complementing installed door sealing solutions, they can be used in conjunction with automatic door bottom seals. Made from high quality, durable

polypropylene brush pile, they are easily self-adhered to the bottom corner of the hinge side of the door frame and the latch side of the frame (provided a nominal 3mm gap exists between door & jamb).

- Improved acoustic performance
- Helps restrict air and light penetration
- Self-adhesive backing provides easy installation



Talk to us today!

www.kilargo.com.au



Kilargo

dormakaba Group

REPLACEMENT GASKET & SEAL COMPONENTS

Gaskets

Illustrations not to scale



Product code:	ISRG-3015si	ISRG-3016si	ISRG-3017si	ISRG-3020si	ISRG-3021si	ISRG-3070si	ISRG-3080si
Use with:	IS3015si	IS3016si	IS3017si IS3022si	IS3020si	IS3021si	IS3070si FDBU20 FDBU60-35 FDBU60-45	IS3080si

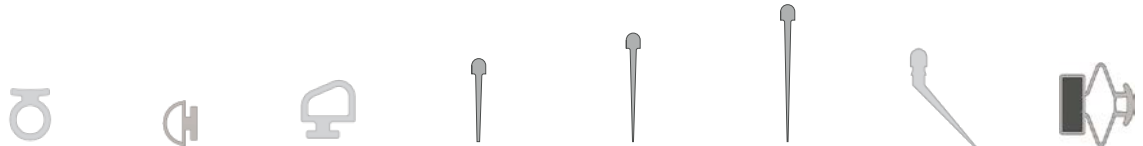

Product code:	ISRG-4078si	ISRG-4220si	ISRG-4226si	ISRG-5111si	ISRG-5116si	ISRG-5121si	ISRG-5177Asi	ISRG-6015
Use with:	IS4078si	IS4220si	IS4226si	IS5111si	IS5116si	IS5121si	IS5177Asi	IS6015 IS6020 IS6030



Product code:	ISRG-7025si	ISRG-7060si	ISRG-7061	ISRG-7071si	ISRG-7080si	ISRG-7085si	ISRG-7087si
Use with:	IS7010si IS7020si IS7025si	IS7060si	IS7061	IS7071si	IS7080si IS7080	IS7085si	IS7087si



Product code:	ISRG-7090si	ISRG-7095si	ISRG-7110si	ISRG-7130si	ISRG-7310si	ISRG-7320si	ISRG-7330si	ISRG-7340si
Use with:	IS7090si IS7190si IS7195si	IS7095si	IS7110si	IS7130si	IS7310si	IS7320si	IS7330si	IS7340si IS7350si



Product code:	ISRG-7345si	ISRG-8005si	ISRG-8010si	ISRG-8090si	ISRG-8110si	ISRG-8210si	ISRG-8520si INNER	ISRG-8520si OUTER
Use with:	IS7345si IS7355si	IS8005si IS8035si IS8036si	IS8010si IS8011si	IS8090si IS8020si IS8091si IS8100si	IS8110si	IS8210si	IS8520si IS8530si	IS8520si IS8530si



Product code:	ISRG-9050	ISRG-9055	ISRG-9070	ISRG-TBAR
Use with:	IS9050	IS9055	IS9070	FDMS-TP

Gaskets (Vinyl Feet)

Illustrations not to scale



Product code:	ISRG-4010	ISRG-4030	ISRG-4070A	ISRG-4070B
Use with:	IS4010 IS4015 IS4020 IS4025 IS4220si	IS4030 IS4035 IS4040 IS4045 IS4100	IS4070 IS4075 IS4077 IS4078si IS4080	IS4070 IS4075 IS4077 IS4078si IS4080 IS4226si

Cover Plates and Strips



Product code:	ISRC	ISRC-4100CP	ISRC-7010CP	ISRC-7020CP
Use with:	IS3070si IS3080si IS6015 IS6030 IS7025si IS7080 IS7080si IS7085si IS7110si IS8035si IS9010 IS9050 IS9055 IS9070 FDBU20 (Available in grey & black)	IS4100 IS4140	IS7010si	IS7020si



Product code:	ISRC-7087CP	ISRC-7087CS	ISRC-7090CP	ISRC-7095CP	ISRC-7095CS	ISRC-7195CP
Use with:	IS7087si	IS7087si	IS7090si IS7190si	IS7095si	IS7095si	IS7195si



Product code:	ISRC-8020CP	ISRG-8036CP	ISRG-8091CP
Use with:	IS8020si	IS8036si	IS8091si

Gaskets and Seals

Seal Components (End Plates)

Illustrations not to scale

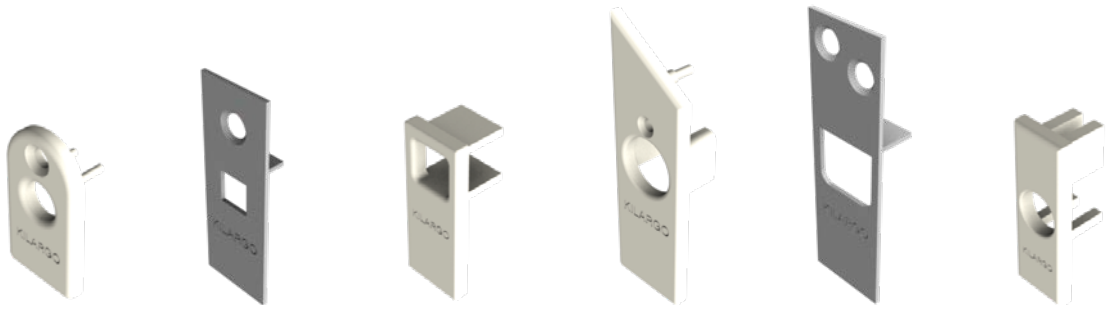

Product code:	ISRC-8005EPP	ISRC-8010EPP	ISRC-8011EPP	ISRC-8020EPP	ISRC-8020SEPP	ISRC-8035EPP
Use with:	IS8005si	IS8010si	IS8011si	IS8020si <i>(Face-Fixed reinforced nylon end plates)</i>	IS8020si <i>(Fully-mortised stainless steel end plates)</i>	IS8035si



Product code:	ISRC-8036EPP	ISRC-8090EPP	ISRC-8090AEP	ISRC-8091EPP	ISRC-8210EPP
Use with:	IS8036si	IS8090si IS8100si IS8520si IS8530si <i>(Face-fixed reinforced nylon end plates)</i>	IS8090si IS8100si IS8520si IS8530si <i>(Cast aluminium end plates for semi-mortised applications)</i>	IS8091si	IS8210si

Homegrown Familiarity

Products made in Australia, to Australia's high standards

We are proud to be an Australian company with a global focus and presence. The vast majority of our products are manufactured and sourced in Australia.

This allows us to offer our customers:



outstanding quality



dedicated customer support



short lead times and fast turnaround



customised product manufacture.



www.kilargo.com.au

Index

FDBU20	12, 99, 101, 102, 155, 176, 177	IS4020	10, 30, 177	IS5176Asi	10, 43, 161
FDBU60-35	12, 100, 176	IS4025	10, 30, 177	IS5177Asi	10, 13, 43, 176
FDBU60-45	12, 100, 176	IS4030	10, 31, 177	IS5177Asi	10, 13, 43, 176
FDMS-BB	12, 98, 149, 151	IS4035	10, 31, 177	IS6015	11, 46, 176, 177
FDMS-TP	12, 97, 121, 122, 141, 142, 149, 151, 153, 176	IS4040	10, 31, 177	IS6020	11, 47, 176
IFD-D	12, 103, 156	IS4045	10, 31, 177	IS6030	11, 48, 123, 126, 176, 177
IS0511	10, 18, 88, 124, 125, 126, 132, 133, 134, 143, 144	IS4050s	10, 32	IS7010AMsi	13, 107
IS0602AMsi	13	IS4055s	10, 32	IS7010si	11, 50, 113, 115, 118, 176, 177
IS0602si	10, 19, 169	IS4060s	10, 32	IS7020AMsi	13, 107, 108
IS1002AMsi	13	IS4065s	10, 32	IS7020si	11, 50, 114, 116, 118, 176, 177
IS1002si	10, 19	IS4070	10, 33, 167, 177	IS7025AMsi	13
IS1005AMsi	13	IS4075	10, 33, 177	IS7025si	11, 51, 112, 113, 115, 116, 118, 119, 120, 122, 126, 136, 138, 139, 140, 141, 142, 152, 166, 176, 177
IS1005si	10, 20	IS4077	10, 33, 177	IS7060AMsi	13, 108
IS1006AMsi	13	IS4078si	10, 33, 176, 177	IS7060si	11, 52, 116, 118, 125, 126, 138, 139, 167, 176
IS1006si	10, 20, 160, 167, 172	IS4080	10, 34, 177	IS7061	11, 53, 115, 116, 118, 138, 139, 143, 144, 176
IS1007AMsi	13	IS4100	10, 26, 34, 177	IS7062	11, 54
IS1007si	10, 20	IS4110	10, 35	IS7071AMsi	13, 107, 108
IS1008AMsi	13	IS4120	10, 35	IS7071si	11, 55, 115, 117, 118, 133, 138, 139, 143, 144, 169, 176
IS1008si	10, 20	IS4130	10, 35, 126, 143, 144, 166	IS7080	11, 56, 176, 177
IS1046AMsi	13	IS4135	10, 36	IS7080AMsi	13
IS1046si	10, 21, 123, 126	IS4140	10, 36, 177	IS7080si	11, 56, 113, 114, 116, 117, 118, 120, 122, 124, 125, 126, 137, 138, 139, 140, 141, 142, 144, 152, 167, 176, 177
IS1212	10, 16, 17, 88, 112, 115, 116, 118, 119, 121, 122, 124, 125, 126, 135, 138, 139, 140, 141, 142, 150, 152, 153, 162, 166	IS4220si	10, 37, 123, 124, 126, 176, 177	IS7085AMsi	13, 107
IS1515	10, 16, 17, 88, 118, 123, 124, 125, 126	IS4226si	10, 38, 115, 118, 125, 126, 176, 177	IS7085si	11, 57, 118, 126, 152, 176, 177
IS3015AMsi	13	IS5110	10, 40, 168, 170, 171	IS7087si	11, 58, 114, 117, 118, 124, 125, 126, 153, 176, 177
IS3015si	10, 24, 176	IS5110B	10, 40, 160, 168, 172	IS7090AMsi	13
IS3016AMsi	13	IS5111AMsi	13	IS7090si	11, 59, 118, 126, 176, 177
IS3016si	10, 24, 176	IS5111si	10, 41, 117, 118, 119, 122, 133, 143, 144, 160, 161, 162, 167, 168, 169, 171, 172, 176	IS7095si	11, 60, 118, 176, 177
IS3017AMsi	13	IS5115	10, 40, 171	IS7110AMs	13
IS3017si	10, 24, 170, 176	IS5115B	10, 40, 170	IS7110si	11, 61, 167, 176, 177
IS3020AMsi	13	IS5116AMsi	13	IS7130AMsi	13
IS3020si	10, 25, 162, 173, 176	IS5116si	10, 41, 176	IS7130si	11, 62, 176
IS3021AMsi	13	IS5120	10, 40, 160, 173	IS7190AMsi	13
IS3021si	10, 25, 160, 161, 173, 176	IS5120B	10, 40	IS7190si	11, 63, 115, 118, 176, 177
IS3022AMsi	13, 108	IS5121AMsi	13	IS7195AMsi	13, 107
IS3022si	10, 25, 133, 166, 169, 176	IS5121si	10, 41, 176	IS7195si	11, 64, 114, 118, 121, 122, 123, 126, 137, 139, 141, 142, 176, 177
IS3070si	10, 26, 34, 160, 176, 177	IS5130	10, 40	IS7310AMsi	13
IS3080si	10, 27, 126, 167, 176, 177	IS5130B	10, 40		
IS3100si	10, 26, 166, 167	IS5160H	10, 42		
IS4010	10, 30, 133, 167, 169, 177	IS5161HAMsi	13		
IS4015	10, 30, 117, 118, 143, 144, 177	IS5161Hsi	10, 43, 161		
		IS5175A	10, 42, 173		
		IS5176AAMsi	13		

IS7310si.....	11, 65, 176	ISRC-7087CS.....	177	ISRG-7330si.....	176
IS7320AMsi.....	13	ISRC-7090CP.....	177	ISRG-7340si.....	176
IS7320si.....	11, 65, 176	ISRC-7095CP.....	177	ISRG-7345si.....	176
IS7330AMsi.....	13	ISRC-7095CS.....	177	ISRG-8005si.....	176
IS7330si.....	11, 65, 176	ISRC-7195CP.....	177	ISRG-8010si.....	176
IS7340si.....	11, 66, 176	ISRC-8005EPP.....	178	ISRG-8036CP.....	177
IS7345si.....	11, 66, 176	ISRC-8010EPP.....	178	ISRG-8090si.....	176
IS7350si.....	11, 66, 133, 168, 176	ISRC-8011EPP.....	178	ISRG-8091CP.....	177
IS7355si.....	11, 66, 133, 168, 176	ISRC-8020CP.....	177	ISRG-8110si.....	176
IS8005AMsi.....	13	ISRC-8020EPP.....	178	ISRG-8210si.....	176
IS8005si.....	11, 68, 122, 136, 139, 176, 178	ISRC-8020SEPP.....	178	ISRG-8520si INNER.....	176
IS8010AMsi.....	13, 107	ISRC-8035EPP.....	178	ISRG-8520si OUTER.....	176
IS8010si.....	11, 69, 93, 94, 95, 112, 113, 114, 116, 118, 119, 120, 121, 122, 124, 126, 132, 136, 137, 138, 139, 140, 142, 150, 151, 152, 153, 176, 178	ISRC-8036EPP.....	178	ISRG-9050.....	176
IS8011AMsi.....	13	ISRC-8090AEP.....	178	ISRG-9055.....	176
IS8011si.....	11, 70, 112, 113, 115, 116, 118, 119, 122, 126, 133, 136, 139, 140, 142, 150, 152, 176, 178	ISRC-8090EPP.....	178	ISRG-9070.....	176
IS8020AMsi.....	13, 107	ISRC-8091EPP.....	178	ISRG-TBAR.....	176
IS8020si.....	11, 71, 114, 117, 118, 120, 122, 144, 152, 167, 176, 177, 178	ISRC-8210EPP.....	178	KG1202.....	12, 93
IS8035AMsi.....	13	ISRG-3015si.....	176	KG1602.....	12, 93
IS8035si.....	11, 72, 120, 122, 135, 138, 139, 140, 141, 142, 176, 177, 178	ISRG-3016si.....	176	KG1602AS.....	12, 94
IS8036AMsi.....	13, 107	ISRG-3017si.....	176	KG1612BW.....	12, 95, 120, 121, 122, 136, 138, 139, 140, 142, 150, 151
IS8036si.....	11, 72, 176, 177, 178	ISRG-3020si.....	176	KG2512BW.....	12, 96, 150
IS8090AMsi.....	13, 108	ISRG-3021si.....	176	KG4002.....	12, 101, 148, 155
IS8090si.....	11, 73, 113, 114, 115, 116, 118, 120, 121, 122, 123, 124, 126, 134, 136, 137, 138, 139, 141, 142, 152, 176, 178	ISRG-3070si.....	176	KG5102.....	12, 102, 155
IS8091AMsi.....	13, 107	ISRG-3080si.....	176	KP1004.....	12, 88
IS8091si.....	11, 74, 153, 176, 177, 178	ISRG-4010.....	177	KP1504.....	12, 88, 148, 150
IS8100AMsi.....	13	ISRG-4030.....	177	KP1504TS.....	12, 89, 132
IS8100si.....	11, 75, 118, 176, 178	ISRG-4070A.....	177	KP2004.....	12, 88, 148
IS8110si.....	11, 76, 126, 176	ISRG-4070B.....	177	KP2004TS.....	12, 89, 134, 150
IS8210si.....	11, 77, 176, 178	ISRG-4078si.....	176	KP2504.....	12, 88
IS8520Asi.....	13	ISRG-4220si.....	176	KP3107.....	12, 90
IS8520si.....	11, 78, 123, 124, 125, 126, 137, 138, 139, 141, 142, 176, 178	ISRG-4226si.....	176	KP3107SS.....	12, 90
IS8530Asi.....	13	ISRG-5111si.....	176	KP3504TF.....	12, 91, 95, 132, 133, 143, 144
IS8530si.....	11, 79, 137, 139, 176, 178	ISRG-5116si.....	176	KP4204TF.....	12, 92, 93, 94, 134, 150
IS9010.....	11, 82, 177	ISRG-5121si.....	176		
IS9050.....	11, 83, 176, 177	ISRG-5177Asi.....	176		
IS9055.....	11, 83, 176, 177	ISRG-6015.....	176		
IS9070.....	11, 83, 176, 177	ISRG-7025si.....	176		
IS9570.....	11, 84	ISRG-7060si.....	176		
ISRC.....	177	ISRG-7061.....	176		
ISRC-4100CP.....	177	ISRG-7071si.....	176		
ISRC-7010CP.....	177	ISRG-7080si.....	176		
ISRC-7020CP.....	177	ISRG-7085si.....	176		
ISRC-7087CP.....	177	ISRG-7087si.....	176		
		ISRG-7090si.....	176		
		ISRG-7095si.....	176		
		ISRG-7110si.....	176		
		ISRG-7130si.....	176		
		ISRG-7310si.....	176		
		ISRG-7320si.....	176		



P 1300 858 010 E info@kilargo.com.au www.kilargo.com.au



Purchase Kilargo products through Access Hardware to earn 1 Qantas Point per \$1 spent for your business*.
Find out more by calling Access Hardware customer service on 1800 555 600 or visit accesshardware.com.au

*A business must be a Qantas Business Rewards member to earn Qantas points for business. Membership and Qantas Points are subject to Qantas Business Rewards Terms and Conditions at qantasbusinessrewards.com/terms and Access Hardware Terms and Conditions at www.accesshardware.com.au/qbr

Customer Service
1800 555 600

Locksmithing
1800 555 700

FEB 2018