

# AUGER DRIVES PDD-PD50 (SINGLE & 2 SPEED)

## Operator's Manual

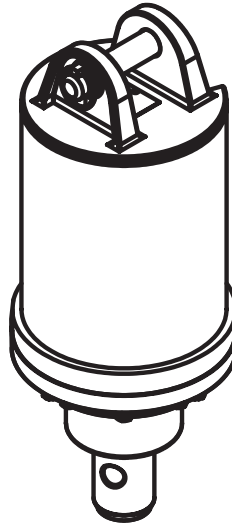

Original Manual

**EARTHMOVING  
WAREHOUSE**



PM-000251

MY.DIGGA.COM

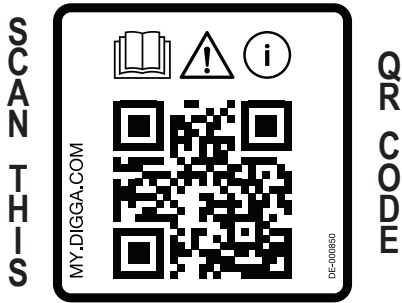

DECAL APPLIED TO THE ATTACHMENT

MY.DIGGA.COM



DECAL TO BE APPLIED TO HOST MACHINE CAB

ACCESS OPERATOR'S MANUALS, RISK ASSESMENTS AND MORE

# 1 Table of Contents

1	Table of Contents.....	3
2	Critical Information - Service Intervals.....	4
3	To the Purchaser.....	5
4	Service and Preparation for Use.....	6
5	Safety Precautions - General Information.....	8
6	Safety - Working with the Attachment.....	14
7	Safety - Decal Labels.....	17
8	Safety - Decal Label Location.....	18
9	Before Use.....	19
10	Commissioning Procedure.....	22
11	Operating Instructions.....	26
12	2 Speed Installations - Electrics.....	35
13	2 Speed Operating Instructions.....	45
14	Maintenance.....	47
15	Spare Parts.....	52
16	Troubleshooting.....	54
17	Halo Alignment System.....	57
18	Notes: Operator's Manual.....	65
	Warranty Statement.....	66

## 2 Critical Information - Service Intervals

### **NOTE**

Do not connect or operate your Planetary drive unit without first having read and understood the following statement.

Your Digga Planetary drive unit is a high performance attachment that is designed for drilling, screw anchoring (Pier) installation, core barreling and other extreme applications where it is seeing high levels of torque. To avoid premature wear and failure, and to fulfil your terms of warranty please read this statement.

**All Digga Planetary drive units must have a first oil change within the first 30 hours (extreme use) or 50 hours (moderate use) or 3 months of use, which ever comes first to ensure the bed in of the drive unit.**

For more detailed information please read the maintenance section of this manual.

**If the first oil change is not performed within this period, excessive wear within the gearbox will occur that will cause premature failure and all Warranty will be voided.**

**Oil must then be changed thereafter every 300 hours (extreme use) or 500 hours (moderate use) and a full service every 12 months must be performed by an authorised service agent to ensure Warranty requirements are met.**

In the event of a failure under the warranty period:

- Contact Digga immediately, do not disassemble your drive without first obtaining written permission and instructions from Digga.
- Proof of service must be provided in hard copy form of both operational and service history records (including serial number of gearbox and hydraulic motor). Service must be performed by an authorised Digga service agent.

### 3 To The Purchaser

Thank you and Congratulations on the purchase of your new Digga Planetary drive unit.

This product was carefully designed and manufactured to give you years of dependable service. It is mandatory that oil changes are performed at the specified interval to keep it in top working condition (for details see the maintenance section of this manual).

#### **Before Operation**

Inspect the attachment for shipping damage and if any damage does exist, do not operate until the damaged parts have been replaced or repaired. The primary responsibility for safety with this equipment falls to the operator. Make sure the equipment is operated only by trained individuals that have read and understood this manual. If there is any portion of this manual or function you do not understand, contact your local authorized Digga dealer or the manufacturer to obtain further assistance. Keep this manual available for reference. Provide the manual to any new owners and/or operators.

#### **About This Manual**

This manual has been designed to help you do a better and safer job. **Read this manual carefully and become familiar with its contents before connecting and operating this unit.**

#### **Service**

Use only manufacturer replacement parts. Substitute parts may not meet the required standards.



#### **CAUTION**

**Never allow anyone operate this attachment without reading the “Safety precautions” and “Operating instructions” sections of this manual. Always choose hard and level ground to park the vehicle on and set the brake, so the unit cannot roll.**

## 4 Service & Preparation for Use

MODELS COVERED IN THIS MANUAL			
SINGLE & TWO SPEED PREMIUM DRIVES			
PDD, PDX, PDZ, PDZ2, PDZ3, PDX2, PDX3, DD3, PD3, PDT3 PD4, PD4HF, PDH Denotes... HALO PDTH... Denotes 2-SPD with HALO PDXH... Denotes PDX with HALO Variant	PD5 PD6/PD6HF PDT6, PDT6HF, PD7 PD8/PD8HF PDT8, PDT8HF, PD10/PD10HF PDT10HF	PD12, PDT12 PD12-5-VIS PD14, PD15 PD18, PDT18 PD18-5-VIS PD22, PDT22,	PD25, PDT25, PD30, PDT30 PD33-7-VIS PD40, PDT40, PD50 PDT50

**During the specified warranty period, your Digga Planetary drive unit is a user non serviceable part and unauthorised disassembly will void warranty.** All service and warranty must be performed by an authorised Digga service agent. Contact your local Digga dealer for details. To facilitate warranty or service, record the model and serial number of your unit in the space provided on this page. This information may be obtained from the identification plate located on the product.

Model: \_\_\_\_\_

Serial Number: \_\_\_\_\_

Purchase Date: \_\_\_\_\_

**DIGGA**  
www.digga.com

Digga Australia PTY LTD  
4 Octavia St, Yatala  
QLD4207 Australia

Model: \_\_\_\_\_  
Name: \_\_\_\_\_  
Serial No.: \_\_\_\_\_  
Flow(max): \_\_\_\_\_  
Pressure(max): \_\_\_\_\_  
Power(max): \_\_\_\_\_ RPM(max): \_\_\_\_\_  
Yr.Manuf: \_\_\_\_\_ Weight: \_\_\_\_\_

DE-000631 MADE IN AUSTRALIA

**\*\*DE-000631 for AUS & NZ**

**DIGGA** CE www.digga.com UK CA

Digga Australia PTY LTD  
4 Octavia St, Yatala  
QLD4207 Australia

Model: \_\_\_\_\_  
Name: \_\_\_\_\_  
Serial No.: \_\_\_\_\_  
Flow(max): \_\_\_\_\_  
Pressure(max): \_\_\_\_\_  
Power(max): \_\_\_\_\_ RPM(max): \_\_\_\_\_  
Yr.Manuf: \_\_\_\_\_ Weight: \_\_\_\_\_

DE-000626 MADE IN AUSTRALIA

**\*\*DE-000626 for EU & UK**

### NOTE

The parts department needs this information to ensure accurate parts can be sent to the authorised service agent.

**\*\* The DIGGA Serial Tag number is dependant on the region as shown above.**

## 4 Service & Preparation for Use

To avoid any inconvenience before operation, please check that you have received the following items which you may have ordered. Items may differ depending on type of machine on which the drive units are to be fitted to.

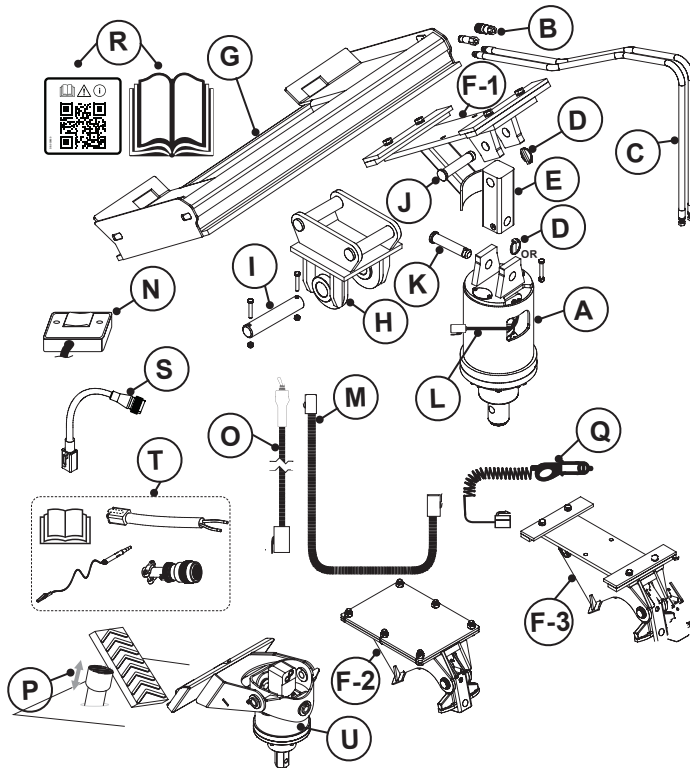

REF	DESCRIPTION	QTY	SINGLE SPEED	2-SPD 12V/2
A	Standard drive unit - or - Swing control system drive unit - or - Halo (see chapter 17)	1	•	•
B	Quick release couplers.	Set	•	•
C	Hydraulic hose kit.	Set	•	•
D	Lynch pin (clip) or bolt.	1	•	•
E	Linkage suit standard drive unit.	1	•	•
K	PIN (Standard drive unit - to - linkage).	1	•	•
L	Digga motor control harness (3M).	1	N/A	•
M	Extension harness 3M/6M/12M/15M.	1	N/A	Optional
N	2 Speed controller.	1	N/A	Optional
O	Remote toggle switch.	1	N/A	Optional
P	Remote floor mounted switch.	1	N/A	Optional
Q	12V/24V Power lead.	1	N/A	Optional
R	QR Code applied to Drive Unit or Manual	1	•	•
REF	FOR SKID STEER LOADERS	QTY	SINGLE SPEED	2-SPD 12V/24V
G	Slide frame.	1	•	•
J	Pin (Cradle - to - linkage).	1	•	•
F-1	Standard slide cradle.	1	•	Optional
F-3	Swing control system cradle (if applicable).	1	•	Optional
S	Adaptor harness kit CAT/ASV/TEREX.	1	N/A	Optional
T	Adaptor harness kit (14-Pin).	1	N/A	Optional
REF	FOR EXCAVATORS	QTY	SINGLE SPEED	2-SPD 12V/24V
H	Standard excavator hitch.	1	•	Optional
I	Linkage (to suit excavator hitch).	1	•	•
F-2	Swing control system cradle (If applicable).	1	•	Optional
REF	FOR MINI LOADER	QTY	SINGLE SPEED	2-SPD 12V/24V
U	Drive unit with mini loader mount.	1	•	N/A
ALL OTHER MACHINES			SINGLE SPEED	2-SPD 12V/24V
Custom made frame to suit.			•	•

\*Note: • Denotes supplied.

## 5 Safety Precautions - General Information

You must understand all safety statements shown on your attachment and in this manual. Especially note the information called out by the designations shown below. Follow these safety precautions, when operating or maintaining the attachment.

### **DANGER**

The DANGER designation indicates an imminently hazardous situation that, if not avoided, will result in death.

### **WARNING**

The WARNING designation indicates a potentially hazardous situation that, if not avoided, could result in death or serious injury.

### **CAUTION**

The CAUTION designation indicates a potentially hazardous situation that, if not avoided, could result in minor or moderate injury or property damage.

### **NOTE**

You will also see information called out with the NOTE designation. This additional safety or general information is important to the maintenance and operation of your loader.

During day-to-day operation of your attachment, you will encounter a variety of situations beyond those listed in this manual. We encourage you to assess the risk present at any job site and in every work task before beginning work. Apply appropriate risk mitigation strategies to make safety a first priority at all times, and if these are not sufficient, stop the job and immediately seek the help of a qualified safety consultant.



## 5 Safety Precautions - General Information

### Dial Before You Dig

- Service provided in Australia. **BeforeUdig** is the service provided in New Zealand.
- Never begin work at a new location until the work area has been fully marked for underground utilities. Buried electrical, telephone, cable wires, gas, water and sewer lines are likely to be present. Unintentionally disrupting these hidden hazards while working with your loader can result in dangerous situations and property damage.
- Many countries offer a “dial before you dig” or similar service which advises the location of underground services in your area. If available also use this service prior to digging, drilling, trenching or any form of excavating and earthmoving.



### **CAUTION**

You must ensure that underground utilities have been officially marked before working in the area. Markings must be valid according to state law or practice.

### Exposure to Respirable Crystalline Silica Dust Along with Other Hazardous Dusts

- It is recommended to use dust suppression, dust collection, and if necessary personal protective equipment during the operation of this or any other machine attachment that may cause high levels of dust.

### Remove Paint Before Welding or Heating

- Hazardous fumes/dust can be generated when paint is heated by welding, soldering, or using a torch. Do all work outside or in a well ventilated area and dispose of paint and solvent properly.
- Remove paint before welding or heating. When sanding or grinding paint, avoid breathing the dust. Wear an approved respirator. If you use solvent or paint stripper, remove stripper with soap and water before welding. Remove solvent or paint stripper containers and other flammable material from area. Allow fumes to disperse at least 15 minutes before welding or heating.

## 5 Safety Precautions - General Information

### End of Life Disposal

- At the completion of the useful life of the Planetary Drive unit, drain all fluids and dismantle by separating the different materials (rubber, steel, and plastic etc.). Follow all federal, state and local regulations for recycling and disposal of the fluid and components.

### Operating the Planetary Drive

- The primary responsibility for safety with this equipment falls to the operator. Make sure that the equipment is operated only by trained individuals, who have read and understood this manual.
- An operator must not use drugs or alcohol, which can change his or her alertness or coordination. An operator taking prescription or over-the-counter drugs should seek medical advice on whether or not he or she can safely operate the equipment.
- Don't hurry the learning process or take the unit for granted.
- It is the skill, care, common sense, and good judgement of the operator that will determine how efficiently and safely the job is performed.
- Visually inspect your equipment, ensure correct assembly and installation is done and never operate the equipment that is not in proper working order.
- Know the capabilities of your equipment and practice its operation to become familiar with the controls, emergency shut down procedures, and the way it handles on your machine.
- Follow all safety decals and keep them clean. Replace them, if they become worn, damaged or illegible.
- Do not paint over, remove or deface any safety signs or warning decals on your equipment.
- Operate only from the operator's station and operate only in daylight or with sufficient artificial light.
- Always carry loads close to the ground and do not exit the machine with the loader arms raised.
- Do not exceed rated operating capacity (ROC) of the host machine, as machine may become unstable resulting in loss of control. Overloading or exceeding the manufacturers specifications will also void all warranty.
- Remove the Auger drive from the parent machine before transporting to and from the job site.

## 5 Safety Precautions - General Information

### Operating the Planetary Drive (Continued)

- Never use the attachment on a machine that is not equipped with a cab rollover protective structure (ROPS) and/or falling object protective structure (FOPS), and operator restraints (seat belts or equivalent devices). Although, this is not applicable when using this attachment on a stand-on mini loader.
- Establish and maintain a minimum 6 meters (20 feet) exclusion zone around the working area. No person other than the operator should enter the work zone, while the parent machine's engine is running.
- Do not allow site workers to climb or ride on Drill mast, Planetary drive, Auger or Auger extension at any time, including while stationary, in operation or being moved.
- Avoid steep hillside operation which could cause the machine to overturn. Consult your machine operator's and safety manual for maximum allowable incline.
- Reduce speed when driving over rough terrain, on a slope or turning to avoid overturning the machine.
- Travel only with the planetary drive in a safe transport position to prevent the uncontrolled movement. Drive slowly over rough ground and on slopes.
- Tether any auger, anchor or extensions connected to the drive with a chain if necessary, to prevent uncontrolled swinging of the attachments.
- Drill stem rotation must be stopped before adding or removing sections, or marking adjustments to the drill stem or sampling equipment.
- Augers shall be cleaned only when the rotating mechanism is in neutral and Auger is stopped. Long handled shovels shall be used to move cuttings from the Auger. Materials heavier than 10 kgs (22 lbs) must be moved mechanically or by two people.
- Do not drive close to ditches and excavations, etc., cave in could result.
- Flow and pressure gauges, fittings, and hoses must have a continuous operating pressure rating of at least 25% higher than the highest pressures of the system.
- All drilling operations must be stopped in the event of local thunderstorm or lightning activity. During operation, weather conditions shall be monitored, operations shall cease during electrical storms or when electrical storms are imminent.

## 5 Safety Precautions - General Information

### **DANGER**

During Auger Drive operation, maintain a minimum “no-work zone” buffer of 3 meters (10 feet) from any overhead electrical service and 2 meters (6 feet) from any underground service .

#### **Ground Personnel and Bystanders**

- Be alert to others in the work area. Be sure others know when and where you will be working.
- Loose fitting clothing, long hair, jewellery and equipment which might become entangled in moving equipment are prohibited while working near the Auger Drive.
- Operators, helpers, and other personnel working near the attachment must wear steel-toe safety shoes, safety glasses, and hard hats as a minimum. Hearing protection, respirators, and personal protective clothing will be specified in the site-specific Health and Safety Plan.

#### **Storing Your Planetary Drive Unit**

- Seal hydraulic couplers from contaminants and secure all hydraulic hoses off the ground to help prevent damage.
- Clean the unit thoroughly by removing all mud, dirt, and grease etc..
- Inspect for visible signs of wear, breakage, or damage. If required, order any damage parts and perform the necessary repairs to avoid delays upon removal from storage.
- Check that drive unit motor and hoses are full of clean oil and planetary gearbox is full.
- Coat liberally with grease the output shaft and collar, extension shaft and collar, and all connecting pins to prevent rust and reduce wear.
- Tighten loose nuts, cap screws, and hydraulic connections.
- Replace safety decals that are damaged or in an unreadable condition.
- Store unit in a dry and protected place, as leaving the unit outside will materially shorten its life.

## 5 Safety Precautions - General Information

### Maintaining the Planetary Drive

- All maintenance should be performed with the engine turned off, parking brakes applied, machine arms lowered, and hydraulic pressure relieved.
- If lift arms must be left raised for any reason, use a positive lift arm lock to secure the arms in place. Serious damage or personal injury could result from lift arms accidentally lowering.
- Never adjust a relief valve for pressure higher than recommended by the machine's manufacturer.

### Transporting the Planetary Drive

- When transporting your attachment, follow all local government regulations that may apply along with any equipment safety precautions provided in this manual.
- It is the responsibility of the operator that safe systems of work are employed while handling this attachment.
- No tie down points are provided on the attachment and its the responsibility of the operator to ensure that the attachment is firmly fastened without causing any damage to it.
- Attachment should be well secured, when being moved or in transit and furthermore prior to moving, storing, loading/unloading, or parking.
- Verify that all tie down accessories (chains, slings, ropes, and shackles etc.) are capable of maintaining attachment stability during transporting and are attached in such a way to prevent unintended disengagement or shifting of the unit.
- Use extra care when loading or unloading the attachment on to a trailer or truck and disconnect hydraulic couplers during the transportation. No responsibility for loss or damage to persons or property in any regard can be attributed to Digga.



All bystanders should be kept at a minimum of 6 meters (20 feet) away from the working area of the Auger drive.

## 6 Safety - Working with the Attachment

### Complete a Risk Assessment

Your Digga Planetary Auger Drive is a versatile earthmoving machinery attachment, capable of performing its tasks in a safe and effective manner. To ensure the safety of operators and others, it is important to document the work at hand for hazard and risk. Before beginning work, complete a risk assessment. The following steps provide a framework for this activity:

1	<b>DOCUMENT THE ACTIVITY</b> Assemble those involved in the activity. Write down the tasks required for the activity in step-by-step form.
2	<b>IDENTIFY THE HAZARDS</b> Next to each task, identify what part of the task may cause injury to those engaged in the task or others in the vicinity. Rate the consequences and likelihood of the hazard using the risk assessment matrix.
3	<b>DOCUMENT THE CONTROL MEASURES</b> Using the results from the risk assessment matrix, determine which hazards require attention. List all mitigation measures that are required to eliminate or minimize those hazards.
4	<b>IDENTIFY THE RESPONSIBLE PERSON</b> Document the name of the person responsible for implementation of the mitigation measure.
5	<b>MONITOR AND REVIEW</b> Ensure that the activity is supervised and that the documented process is being followed.

### **NOTE**

Remember, Personal Protection Equipment (PPE) provides a level of protection during work, but PPE is the last level of hazard control and prevention. Always refer to the hierarchy of hazard control, when planning a safety process.

## 6 Safety - Working with the Attachment

**Take Extreme Care When Dealing with Hydraulics - Whilst Assembling, Operating, Maintaining or Performing any work on or near this product.**

- Hydraulic fluid under pressure can penetrate the skin and may develop gangrene or other permanent disabilities. **Hydraulic leaks under pressure may not be visible!**
- If any fluid penetrates the skin, **get immediate medical attention!**
- Wear safety glasses, protective clothing, and use a sound piece of cardboard or wood when searching for hydraulic leaks. **Do not use your hands!**
- Before connecting or disconnecting hydraulic hoses, read your machine or power unit's operator manual for detailed instructions on connecting and disconnecting hydraulic attachments.
- Ensure that all parts meet the specifications for this product when installing or replacing hydraulic hoses or fittings.
- After connecting hydraulic lines:
  - Slowly and carefully raise the loader's arm(s) and cycle the rollback/dump cylinders to check hose clearances and to check for any interference.
  - Operate the hydraulics on this product to ascertain forward and reverse.
  - Ensure that the hoses cannot interfere with or actuate the quick-attach mechanism.
  - Ensure that hoses will not be pinched, or get tangled, in any equipment.
- Do not lock the auxiliary hydraulics of your Planetary Drive unit in the "ON" position.
- Refer to host machine operator's manual and this manual for procedures and service intervals, then inspect and maintain the entire hydraulic system to insure that the fluid remains clean, that all devices function properly, and that there are no fluid leaks.

### **NOTE**

For any additional safety information please see "Risk Management Booklet". To obtain a copy of this document please contact Digga Head Office.

## **6 Safety - Working with the Attachment**

### **When Mounting this Product to Your Machine**

- Refer to the operator's manual of your host machine for any special or detailed mounting instructions regarding quick-attach mechanism.
- This product should fit onto the quick-attach frame or hitch (machine mount). If this product does not fit properly, contact your Digga dealer before operating.
- Never place any part of your body into the mounting plate, frame, hitch or loader holes. A slight movement of the power unit and this product could cause serious injury.
- Where 'Dead Man' connections are connected or installed it is illegal to disengage, tamper with, or remove them.





### **When Adjusting Servicing or Repairing this Product**

- Do not make any modifications to your Digga Planetary drive unit.
- When making repairs use only authorised Digga service agents and use only genuine Digga parts for the gearbox. For fasteners, hydraulic hoses, or hydraulic fittings, use only properly rated parts.
- Replacement parts must also have safety signs attached.

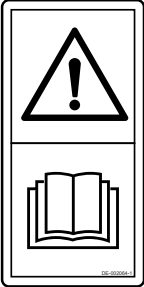
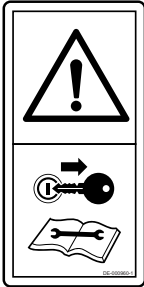

## 7 Safety - Decal Labels

The following section provides a glossary of safety labels found on your Digga Planetary drive unit. These labels are important! Become familiar with both their meaning and location prior to operating your drive unit. They must be maintained and ensure that each label is clean, visible, and legible. To clean the decal, use a soft cloth, water, and soap. Avoid the use of solvents, gasoline, or other harsh chemicals, as these may damage the decal. If a label has been damaged or removed, it must be replaced.

READ OPERATOR'S MANUAL	REMOVE IGNITION KEY	ENTANGLEMENT / CRUSH HAZARD
		
<p> <b>DANGER</b>            Completely read and understand this operator's manual before using your attachment. Keep the manual with the attachment at all times.</p>	<p> <b>CAUTION</b>            Before performing any maintenance on the Planetary drive or attachment, switch engine off and remove the key. Never leave the key in an unattended machine.</p>	<p> <b>CAUTION</b>            Keep hands and body parts clear of auger drive. Keep all bystanders at a safe distance (6 meters/20 feet) from operating auger drive and work zone. Refer to this operator's manual for more information.</p>

## 8 Safety - Decal Label Location

### NOTE

The following figure and table show typical safety decal labels location. The actual position and quantity of the labels on your product may differ.

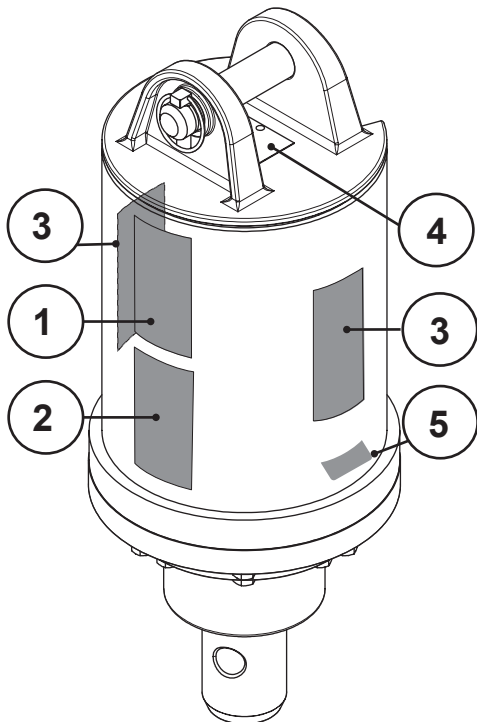

ITEM	RE-ORDER CODE		QTY
	PDD - PDX3	PD3 - PD50	
1	DE-002064-1-SM	DE-002064-1	1
2	DE-000960-1-SM	DE-000960-1	1
3	DE-000630-1-SM	DE-000630-1	2
4	DE-000626	DE-000626 EU/UK	1
	DE-000631	DE-000631 AUS/NZ	1
5	DE-000046	DE-000046 AUS/NZ	1

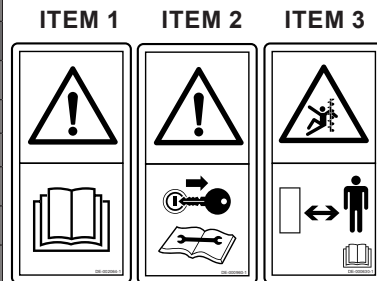

ITEM 4

<b>DIGGA</b> www.digga.com	<input type="checkbox"/> DiggaAustraliaPTYLTD 4OcalaSt, Yatala QLD4207Australia <small>DE-000631 MADE IN AUSTRALIA</small>
Model	<input type="text"/>
Name	<input type="text"/>
Serial No.	<input type="text"/>
Flow(max)	<input type="text"/>
Pressure(max)	<input type="text"/>
Power(max)	<input type="text"/> RPM(max) <input type="text"/>
Approx OilCapacity	<input type="text"/> Yr.Manuf. <input type="text"/> Weight <input type="text"/>

\*\*DE-000631 for AUS & NZ

ITEM 4

<b>DIGGA</b> www.digga.com	<input type="checkbox"/> DiggaAustraliaPTYLTD 4OcalaSt, Yatala QLD4207Australia <small>DE-000626 MADE IN AUSTRALIA</small>	<b>CE</b> <b>UK</b> <small>CA</small>
Model	<input type="text"/>	
Name	<input type="text"/>	
Serial No.	<input type="text"/>	
Flow(max)	<input type="text"/>	
Pressure(max)	<input type="text"/>	
Power(max)	<input type="text"/> RPM(max) <input type="text"/>	
Approx OilCapacity	<input type="text"/> Yr.Manuf. <input type="text"/> Weight <input type="text"/>	

\*\*DE-000626 for EU & UK

ITEM 5



AUS/NZ Only

### NOTE

ITEM 5 - This **DIAL BEFORE YOU DIG** Decal is applicable for Australia & NZ only. All other regions should have a similar service available.

## 9 Before Use

The key feature of your Digga Planetary drive is low maintenance, regular oil changes only are required. It contains no user serviceable parts, unauthorised disassembly will void warranty. **Written permission from Digga must be obtained before performing any disassembly.**

### Before First Use

Inspect the drive unit for shipping damage. If damage does exist, do not operate until the damaged parts have been replaced or repaired.

### Before Each Use

- Make sure that all nuts and bolts are in place and properly tightened.
- Make sure that all other fasteners are in place and are performing their specified function.
- Make sure that all hydraulic fittings are tightened and that there are no leaks in any fittings or hoses.
- Make sure that all safety signs are in place, are clean, and are legible (see the safety sign section).
- Check for any oil leaks, wear and tear on pins, linkages, clips, bushes and hood.
- Ensure any damage or excessively worn parts are replaced.
- Always wear safety goggles or glasses when inspecting equipment.

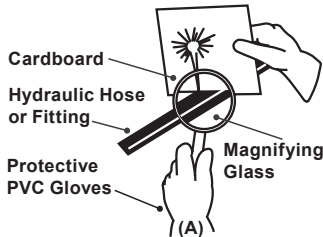

### **WARNING**

Escaping fluid under pressure as low as 100 PSI can have sufficient force to penetrate the skin up to 4" (100mm) away causing serious personal injury. Fluid escaping from a very small hole can be almost invisible. Use a piece of cardboard or wood, rather than hands to search for suspected leaks (A). Keep unprotected body parts, such as face, eyes, and arms as far away as possible from a suspected leak and use heavy duty PVC protective gloves. Flesh injected with hydraulic fluid may develop gangrene or other permanent disabilities.

## 9 Before Use

### **WARNING**

Always wear the correct PPE, when operating or performing maintenance on this attachment. If a hydraulic fluid injection injury occurs, seek emergency medical attention immediately. Explain to medical staff that the injury is the result of pressurised fluid injection. Remember even if the point of entry appears as a minor pin hole, this potentially could be a major injury, especially if not treated in time.

### Operating Parameters - HP (KW) Power Ratings

The hydraulic motor of your Planetary drive unit has a maximum power rating. Maximum Pressure & Flow cannot be achieved at the same time. Ensure you know and understand the maximum flow, pressure and power ratings of your drive unit and parent machine. Never exceed the maximum ratings listed below. The following charts indicate the maximum capacities of the drive unit.

MODEL				MAX POWER		MAXIMUM FLOW		MAXIMUM PRESSURE	
MODEL	**PRV	**ECV	Case Drain	HP	Kw	LPM @ BAR		BAR @ LPM	
PDD	Optional	Optional	Optional	34	25	95	140	240	60
PDX	Optional	Optional	Optional	34	25	95	155	240	60
PDZ3	N/A	N/A	N/A	34	25	70	200	240	60
PDX2	Optional	Optional	Optional	34	25	95	155	240	60
PDX3	Optional	Optional	Optional	34	25	95	155	240	60
PD3	Optional	Optional	Optional	34	25	115	130	240	60
PD4	Optional	Optional	Optional	34	25	115	130	240	60
PD5	Optional	Optional	Optional	34	25	115	130	240	60
PD6	Optional	Optional	Optional	34	25	115	130	240	60
PD7	Optional	Optional	Optional	34	25	115	130	240	60
PD8	Optional	Optional	Optional	34	25	115	130	240	60
PD10	Optional	Optional	Optional	34	25	115	130	240	60
PD4HF	Optional	Optional	Optional	67	50	170	180	240	130
PD6HF	Optional	Optional	Optional	67	50	210	145	240	130
PD8HF	Optional	Optional	Optional	67	50	230	130	240	130
PD10HF	Optional	Optional	Optional	67	50	230	130	240	130

\*\* PRV - Pressure Relief Valve & \*\*ECV - Energy Control Valve

# 9 Before Use

MODEL				MAX POWER		MAXIMUM FLOW		MAXIMUM PRESSURE	
MODEL	**PRV	**ECV	Case Drain	HP	Kw	LPM @ BAR		BAR @ LPM	
PD12	Optional	Optional	Optional	67	50	230	130	240	130
PD15	Optional	Optional	Optional	67	50	210	145	240	130
PD18	Optional	Optional	Optional	67	50	230	130	240	130
PD22	Optional	Optional	Optional	67	50	230	130	240	130
PD25	Optional	Optional	Optional	67	50	230	130	240	130
PD30	Optional	Optional	Optional	67	50	230	130	240	130
PD40	Optional	Optional	Optional	67	50	230	130	240	130
PD50	Optional	Optional	Optional	67	50	230	130	240	130
<b>2 SPEED DRIVE UNITS - STANDARD FLOW</b>									
PDT3	Optional	Optional	N/A	34	25	76	200	200	76
PDT6	Optional	Optional	N/A	34	25	76	200	200	76
PDT8	Optional	Optional	N/A	34	25	76	150	205	60
PDT10	Optional	Optional	N/A	34	25	76	150	205	60
<b>2 SPEED DRIVE UNITS - HIGH FLOW</b>									
PDT4HF	Included	Optional	Included	80	60	180	200	240	150
PDT6HF	Included	Optional	Included	80	60	180	200	240	150
PDT8HF	Included	Optional	Included	80	60	180	200	240	150
PDT10HF	Included	Optional	Included	80	60	180	200	240	150
PDT12	Included	Optional	Included	80	60	180	200	240	150
PDT18	Included	Optional	Included	80	60	180	200	240	150
PDT22	Included	Optional	Included	80	60	180	200	240	150
PDT25	Included	Optional	Included	80	60	180	200	240	150
PDT30	Included	Optional	Included	80	60	180	200	240	150
PDT40	Included	Optional	Included	80	60	180	200	240	150
PDT50	Included	Optional	Included	80	60	180	200	240	150

## 10 Commissioning Procedure

All Digga Planetary drive units are despatched from the factory full of fluids (hydraulic and gearbox oil) unless a warning decal is attached. The decal is only applied in special circumstances, for example if a drive unit needs to be air-freighted to the customer. Air transportation regulation prohibits certain fluids from being air-freighted. If there are no fluids in the drive unit at the time of despatching, then the decal **DE-000127** will be applied to the drive unit.



PART NUMBER: DE-000127

- Once you have determined if the drive unit has gearbox oil in or requires oil, ensure that the correct grade and quantity of oil is used. **Do not run the drive unit without gearbox oil.** Connect the hydraulic hoses and if required, optional 2 Speed electrical harness to the machine. If the customer has ordered the optional Pressure differential kit and the Diggalign kit, then there will be 2 additional electrical harnesses to connect.
- 2 Speed drives fitted with an Eaton VIS motor require a case drain. The case drain hose is already fitted to the hydraulic motor and needs to be connected to the hydraulic line which returns to the hydraulic tank of the host machine.

### **CAUTION**

Before the drive unit is even connected to the machine ensure that it is full of hydraulic oil and the gearbox is full of gear oil. For details, see the Maintenance section of this manual.

## 10 Commissioning Procedure

**All Planetary drive units listed in this manual use ISO EP 320 (mineral oil) gearbox oil for operating in tropical ambient temperatures.** See maintenance section of this manual for gearbox oil volume, gearbox oil volume checking as well as the gearbox oil recommended for cold climate conditions. The gearbox oil quantity is also engraved on the serial tag located between the ears of the hood.

To ensure best motor life, run motor for approximate one hour at 30% of rated pressure before application to full load. Be sure that motor and gearbox are full of fluids prior to any load application. When procuring any hose assemblies for use on your Digga Planetary drive unit ensure that the maximum operating pressure of the hoses is always 25% higher than what the excavator or machine can produce (which the planetary drive unit will be used on).

### **NOTE**

**If required, ensure that the case drain hose is connected to the reservoir of the machine. It is important that the pressure in the case drain hose is not reading more than 690kPa (100PSI), whilst operating and that a consistent trickle of hydraulic oil is being returned to the excavator reservoir. Intermittent and spurts of flow from the case drain hose are not standard design symptoms. If this occurs, please consult a Digga Dealer or Digga Head Office.**

# 10 Commissioning Procedure

## Installing your Planetary drive

- Remove the shipping banding from around the attachment.
- Ensure you have read the serial tag on the drive unit to obtain the maximum flow and pressure ratings, and your machine flow and pressure settings are aligned with the requirements of the drive unit. **Never exceed the maximum flow and pressure ratings as warranty will be voided.**
- Follow all standard safety practices and the instructions for installing an attachment as shown in your machine operator's manual.
- Lower the unit to the ground and remove any attachments from the front of the host machine.
- Attach the quick attach mounting frame or hitch to the host machine as per the machine manufacturers specifications. Ensure the locking mechanisms on the machine are engaged & the attachment is secure.
- Relieve any pressure from the auxiliary hydraulic system and after making sure there is no foreign matter on the hydraulic couplers, connect the power and return couplers to the auxiliary hydraulic system of your machine. The list below shows the most common places to “tap” into the hydraulic system on various types of machines.
  - Skid Steer Loaders - Auxiliary hydraulic outlets.
  - Backhoes & Excavators - Auxiliary hydraulic outlets or bucket curl cylinder circuit.
  - Wheel Loaders - Auxiliary hydraulic outlets or bucket tilt (dump) cylinder circuit.
- If applicable connect the case drain coupler to the case drain on your machine. If your machine has a case tap, ensure the case tap is open. Failure to connect the case drain will severely damage the motor and void all warranty. Case drain hose is already fitted to the units hydraulic motor and must be unraveled. This case drain hose must return directly to hydraulic oil reservoir on the parent machine. There can be no valving or restrictions in the line and the hose inner diameter must be minimum 1/2" (12.7 mm) . The loose end of this case drain line must have a fitting fitted to match the fitting on the parent machine.



## 10 Commissioning Procedure

- **Variable foot control** - It is recommended that excavators used to power drive units have their auxiliary circuit controlled with a variable foot control. This foot control gives the operator the ability to ease the power on and off avoiding shock loading, which will cause potential expensive damage to the hydraulic motor and gearbox.
- **Filtration/Contamination** - These units are fitted with a hydraulic motor, therefore require the oil to be of suitable cleanliness. Ensure hoses are clear of any contamination during connecting/disconnecting to prevent contaminants entering the hydraulic motor.
- With the unit lying horizontally on the ground connect the auger, screw anchor or extension or core barrel. Ensure the auger and safety clip are installed correctly. The machine is now ready for use.

If augering, check the auger teeth and pilots are not worn. Ensure all worn parts are replaced. Worn parts will become ineffective and severely diminish the overall performance of the Planetary drive and Auger.

### **NOTE**

Ensure that the locking mechanism on your quick attach is engaged, therefore locking the attachment onto the machine. If there is any portion of this manual that you do not understand, contact your Digga dealer or Digga Head Office. Altering, tampering or dismantling any part of the Digga drive unit without written permission from Digga will void any warranty.



### **WARNING**

Ensure that there are no quick release couplers and/or the T-connectors. Operation without case drain will cause motor failure for 2-Speed (High flow) drive units only .

# 11 Operating Instructions

## Cold Weather Startup Information

The information that is contained on this page is an aid to the operation and maintenance of your Digga planetary drive unit in cold weather. When you operate the host machine in temperatures from 9°C (48°F) to -40°C (-40°F) refer to the operation and maintenance manual of your machine. It is difficult to outline the operation and maintenance of a machine that is used in freezing temperatures for a general publication. The difficulty in outlining the requirements is caused by the following conditions:

- The unlimited differences in weather conditions
- Applications and ground conditions
- Supplies that are available in your area

In order to provide the best possible guidelines, use the information provided in this manual and other criteria such as: varying factors, recommendations from your machinery dealer, and past proven practices.

## Hints for Cold Weather

Make sure that you read the information for selecting the correct oils for use in cold weather. For details refer to the Maintenance section of this manual. Prepare the machine for the weather conditions as instructed in your machines operator's manual.

## Procedure for Startup in Cold Weather

- Your Digga Planetary drive unit is designed to operate within ambient temperatures of 5°C (41°F) and 30°C (86°F).
- For temperatures below 5°C (41°F) it is recommended to slowly start the drive under no load, at minimum speed. This will allow warm hydraulic oil from your host machine to circulate through the hydraulic motor of your drive and slowly bring it to the minimum recommended operating temperature.

# 11 Operating Instructions

- Once the minimum temperature has been achieved it is recommended to slowly introduce load to the output of the drive unit, which in turn will increase the internal gear oil temperature.

**Note:** The host machines cooling system and the lubrication system for the engine do not lose heat immediately upon shutdown. The transmission and the hydraulic system lose heat more rapidly because of more exposed areas. The Planetary gearbox & motor cases cool rapidly, since the cases do not operate as warm as other compartments. Therefore, after any period of down time on the machine, ensure you achieve full operating temperatures through following start up instructions. Thick oil can also cause high case pressures which in turn cause shaft seal problems.

## Operating Procedure - AUGERING

- This unit is designed for drilling vertical or horizontal holes or rotating piers into the ground. Use in any other way is considered contrary to the intended use. After all installation instructions have been completed, safety information read and understood, and the rest of this operator's manual has been reviewed, your Digga Auger Drive is now ready for use.
- With the auger raised off the ground and the host machine's engine set at a low RPM, activate the host machine's drive control valve to determine which position the control valve lever must be in to turn auger in a forward (clockwise) rotation. This is the "digging" position.
- Before beginning to dig, experiment with auger speed to determine a suitable auger RPM. Generally in light and sandy soil a high RPM is desirable. In hard, rocky, or frozen soils a slower RPM is desirable. To increase auger RPM, increase host machine's engine RPM. To decrease auger RPM, decrease host machine's engine RPM.
- Raise the Auger Drive so the auger hangs vertical and the drive is clear of the cradle, then lower the auger into the starting position.



## **CAUTION**

Your Digga Planetary drive is specifically designed for drilling and rotational operation only, it is not a lifting device!

## 11 Operating Instructions

- Ensure the crowd on your machine is forward and not back. This will keep the drive unit clear of the cradle and allow the auger to move freely from side to side and forward and back. The pendulum action must not be hindered otherwise damage / bending of the shaft or auger may occur. Lower the auger into the ground ensuring the auger drive does not stall and remains in a vertical position, start rotation of the auger.
- As the auger starts to load up with spoil, stop the rotation whilst still in the hole and raise the auger vertically. Move away from the hole, rotate the auger & stop, rotate the auger & stop in the forward direction to remove the spoil. **Do not rapidly engage forward/reverse action to remove spoil.**
- Do not remove the auger on an angle out of the hole, as you will run the increased risk of bending the auger or shaft.
- If trying to remove the auger full of material and you experience strong resistance, reverse the auger slowly whilst raising the auger vertically to assist with removal. Do not pull with the machine as you may run the risk of shaft damage to the drive.
- Do not flick the dirt (especially mud or clay) from the auger, as you may run the increased risk of bending the auger shaft.
- Keep clearing the auger hole regularly as you drill deeper. This will help prolong the life of the auger and the wear parts. In rocks it is recommended to add a slow stream of water to help the performance and life of the rock teeth.



### **CAUTION**

Do not rapidly engage forward reverse operation to remove soil from the Auger, this creates excessive pressure spikes which will adversely effect performance and longevity of the motor.

# 11 Operating Instructions

**For Excavators** - Apply the greatest amount of down force from the main boom. Be aware that the boom moves in an arc and to maintain a plumb drilling position. You will need to compensate for this movement by adjusting the dipper arm or moving your machine backwards or forwards to ensure you are drilling straight. You must take extreme care when doing this to prevent the auger or screw pile from bending or pulling flights against the inside of the hole.

**For All Other Machines** - Ensure the vertical position is maintained when drilling.

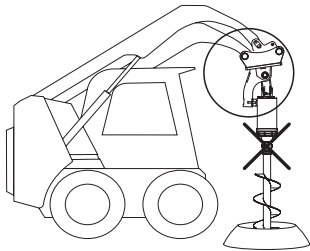

(B)

Do not drill with the cradle resting against the drive unit **(B)**-This will damage your Drive unit & Auger.

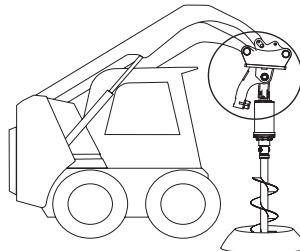

(C)

The correct drilling operation is with the cradle positioned up and away from the drive unit allowing the drive and Auger to swing freely left, right, forward & back **(C)**.

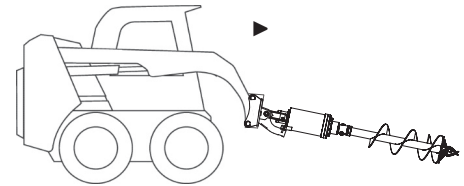

(D)

For manoeuvring around the job site, the cradle is positioned so the Drive unit is resting against the cradle arm & the loader arms are not obstructing visibility **(D)** .

# 11 Operating Instructions

## Operating Procedure - EXTENSIONS & TELESCOPIC AUGER EXTENSIONS

- Once you have obtained the maximum depth with the extension & auger you have, raise the auger out of the hole & clear the spoil from the auger. Place the auger back into the hole ensuring the auger is bottomed out in the hole & the hub of the extension is clear & easily accessible. Remove the auger pin to disengage the drive unit from the auger.



### **CAUTION**

Ensure personal safety at all times, determine if access to the auger hub, once the auger is in the hole, is safe, if not safe for persons assisting, place boards or covers across the hole before attempting to reach across to the hub.

- Install the additional extension onto the auger drive with pin & safety clip, lower the extension & attach to the auger with second pin & safety clip. Always ensure persons assisting are clear & visible to the operator at all times.
- Recommence drilling, once you have reached the maximum depth, raise the auger and extension out of the hole until the eyelets of the extension are visible & just above the hole. Slide the two support bars through the two heavy duty eyelets or U-brackets welded to the outer extension. Either then remove the pin & section of extension and place away from the hole. Then re-pin back to the bottom section, take the weight of the rest of the extension & auger on the machine & remove the support bars. Clear the auger & then keep repeating these steps.
- For telescopic extensions, use the same method as above, but slide the inner extension back into the auger & pin.

### **NOTE**

Digga does not accept any liability for injury or damage resulting from the operator using the extension (s) outside the designed operating procedure.

# 11 Operating Instructions

## Operating Procedure - SCREW ANCHORING (PILE/PIER)

- Installation is to be performed by a trained and/or certified installer.
- Connect the manufacturer's approved adapters to the Planetary drive head. If you have two speed operation, start installation in the high speed, low torque setting and start installing pile. As the pressure builds & the torque increases, change the two speed controller to High Torque low speed and complete the pile installation to your required depth and torque. If your drive is single speed install the pile in one continuous motion until the desired depth and torque is achieved.
- Install pile/pier with a continuous motion. The rate should match the pitch on the pile. Make sure to apply just enough downward pressure to help the advancement of the pile into the ground, but not to much that you are driving or drilling the pile into the ground. Always maintain a plumb line so that you do not bend the pile.

**All 2 Stage reduction Planetary model drives (PD15-PD50) specified for anchoring applications must be fitted with an optional ECV - Energy Control Valve (Patented).** During the screw anchoring process energy builds up in the pile/pier, when the operator stops installation as torque is reached, the pile/pier temporarily 'flicks' back or rotates back forcing energy up the pile/pier, back up through the gear sets and into the motor, momentarily turning the motor into a pump. The ECV is designed to protect the motor from this action and essentially grabs the oil and gently bleeds it back down the hydraulic lines. The sound it makes is a gentle 'swoosh', this is how you know the valve is working. Inefficiencies occur with machinery that can reduce the torque output, such as heat, cold, age of machine etc.. It is therefore highly recommended that Torque monitoring equipment to keep record of the torque and pressure is installed. Contact Digga Head Office or your local Digga Dealer for further information regarding torque monitoring options.

### **NOTE**

**It is the responsibility of the installer to correctly calculate, plan and execute the installation of the piers to the nominated required torques. Digga does not accept any liability or consequential loss that is incurred from incorrect installation, over torquing or under torquing of piles.**

# 11 Operating Instructions

## Optional Extra - SWING CONTROL SYSTEMS (SCS)

If you have purchased a Swing Control System please ensure you read and understand the following operational procedures.



Type 2,4,6,8

Stowed Travel Position For Skid Steers & Excavators.

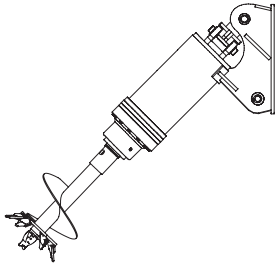

Left to Right Operating Range.

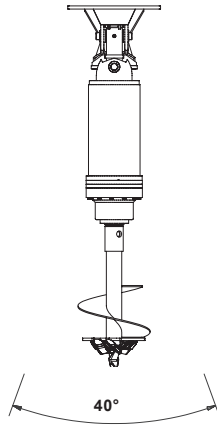

Safe operating Range.

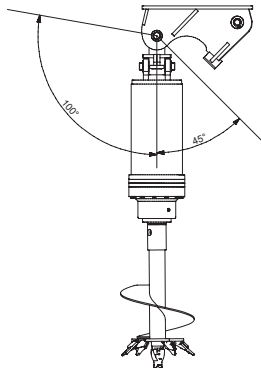

Drill Head is in Stowed Position, Do Not Operate in this Position.

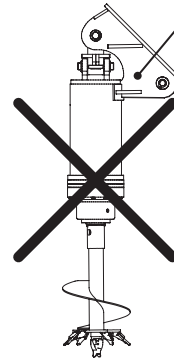

Drill Head is Locked. Do not Operate in this Position, Unit will be damaged.

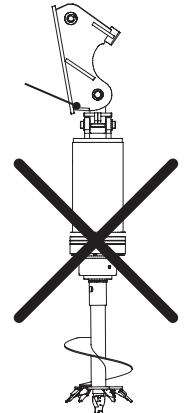



# 11 Operating Instructions

## Optional Extra - RYNO HITCH

If you have purchased a Ryno Hitch please ensure you read and understand the following operational procedures.

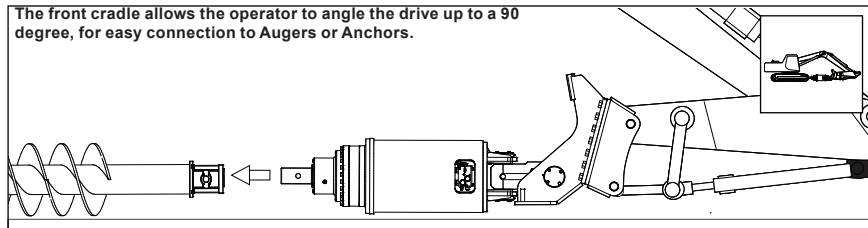
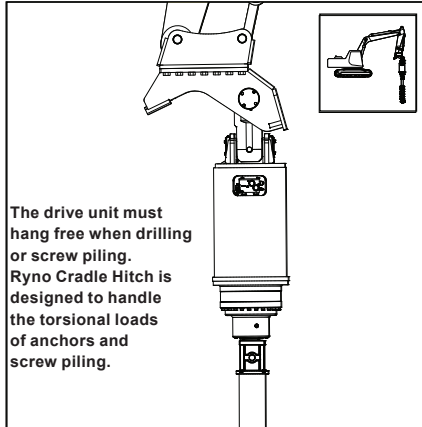
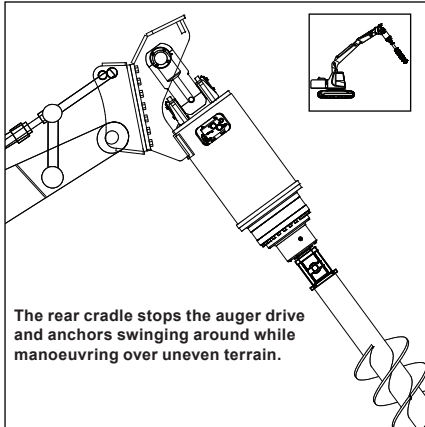

Avoid Pile Installation  
When Hitch is Fully Up.

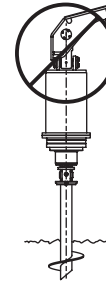

Avoid Pile Installation  
When Hitch is Fully Down.

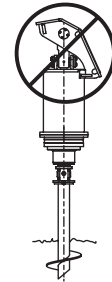

### PILE LOADING

During pile loading, make sure that the linkage is in line with the pile before starting the crowding or lifting action. Failure to do so may lead to damage.

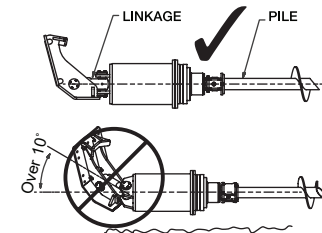

# 11 Operating Instructions

## Optional Extra - CRADLE HITCH

If you have purchased a Cradle Hitch please ensure you read and understand the following operational procedures.

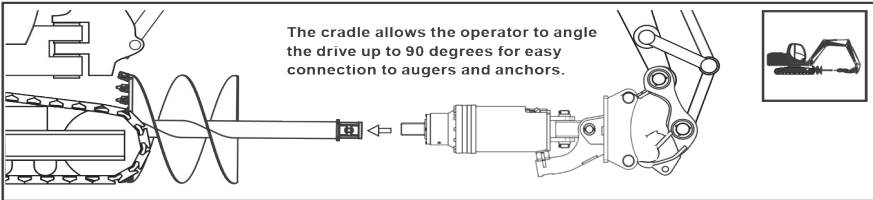
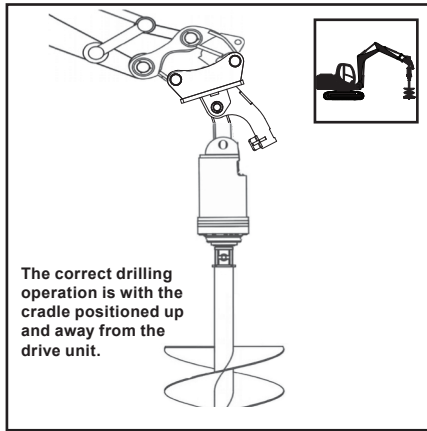
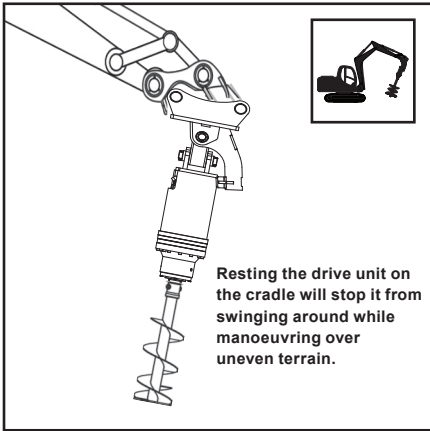

Avoid Pile Installation When Hitch is Fully Up.

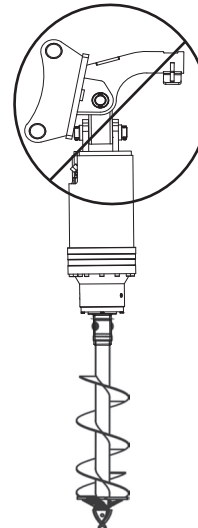

Avoid Pile Installation When Hitch is Fully Down.

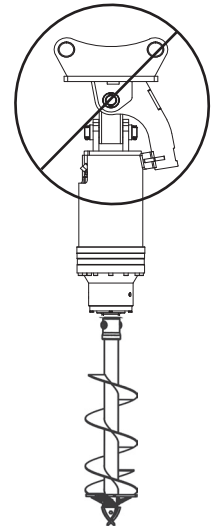

## 12 2 Speed Installations-Electrics

### 2 Speed Drives

The 2 Speed drive can be supplied in either a 12V or 24V system as per customer request. There are 2 ways to electrically power the drive unit.

#### (i) Hard wire from the machine battery

#### 12 Volt Excavator connection diagram to 12V 2 Speed Drive Unit

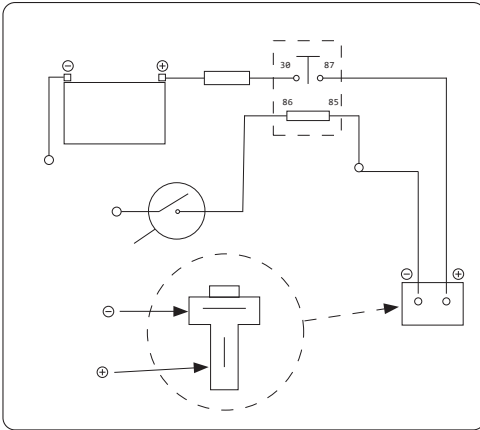

- Connect pin 30 of relay via 10 Amp fuse to battery positive terminal.
- Connect pin 86 of relay to an ignition source.
- Connect pin 85 of relay to chassis ground or battery ground terminal.
- Connect pin 87 of relay to two pin plug to connect to 2 Speed controller harness (this connection point is tagged "supply").
- Connect an earth to the two pin plug to connect to 2 Speed controller harness.

#### 24 Volt Excavator connection diagram to 24V 2 Speed Drive Unit

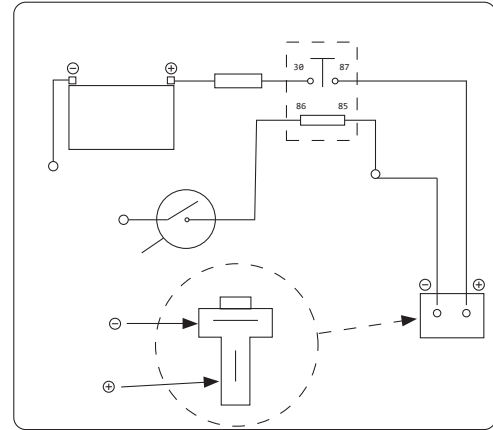

- Connect pin 30 of relay via 10 Amp fuse to battery.
- Connect pin 86 of relay to an ignition source.
- Connect pin 85 of relay to an earth point or earth of battery.
- Connect pin 87 of relay to positive terminal of the 2 pin plug.
- Connect an earth to the two pin plug to connect to the 2 Speed controller harness.

## 12 2 Speed Installations-Electrics

### (ii) Use of Cigarette Lighter power lead

Power lead (B) TC- 000012 comes in as included in Digga's optional Plug and Go 2 Speed Controller Kit. This kit is recommended for telehandlers, backhoes and excavators as well as skid steer loaders (without a service plug). 4 kits are available with 4 different length extension harnesses.

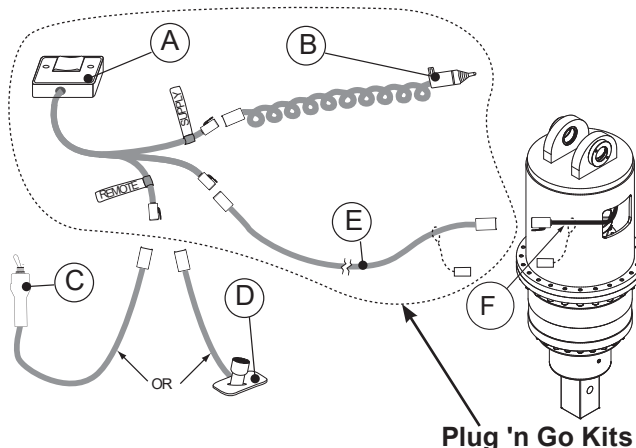

- If the Planetary drive unit is fitted with 24V Solenoid coil, plug the cigarette lighter plug into 24V DC Socket.
- If the Planetary drive unit is fitted with a 12V solenoid coil, plug the cigarette lighter plug into 12V DC socket.
- Do not connect A 12V powered drive unit to a 24V supply.

Plug 'n Go Kits

ITEM	DESCRIPTION
A	Controller 2 Speed
B	12V/24V Power Lead
C	Remote Toggle Switch (OPTIONAL)
D	Remote Floor Mounted Switch (OPTIONAL)
E	Extension Harness - Choose length
F	3m (10ft) Harness - Standard with 2 Speed Drive

KIT PART NUMBER	BOOM EXTENSION HARNESS LENGTH	TO SUIT MACHINE (SUGGESTED)
DM-000037	3M (10FT)	UP TO 5T EXCAVATORS
DM-000034	6M (20FT)	5T TO 8T EXCAVATORS & SKID STEER LOADERS
DM-000038	12M (40FT)	8T TO 16T EXCAVATORS
DM-000039	15M (50FT)	18T + EXCAVATORS

### Variable Displacement Drives (Powered by Linde HMR hydraulic motors)

The Linde HMR hydraulic motor is a pressure regulating motor and has variable displacement. This motor does not use any electrics to change speed.

### Single Speed Drives (EATON 2K and 6K series motors)

These motors do not require electrics.

## 12 2 Speed Installations-Electrics

### Connecting the Optional 2 Speed Harness Kit to an Excavator, Telehandler or Backhoe

The drive unit is connected to the 2 Speed controller (mounted in the Cab) via an extension harness. This harness contours the hydraulic hoses on the boom of an excavator. The extension harnesses are available in 3m (10'), 6m (20'), 12m (40') or 15m (50') length. The boom harness can be attached to the hydraulic lines of the excavator using cable ties (see illustration on the following page).

The optional Electrical harness kit comprises the following parts:

- 1x Extension harness, which is available in 4 different lengths depending on the machine size. These lengths are; 3m (10'), 6m (20'), 12m (40'), and 15m (50').
- 1x 2 Speed controller part number **DM-000013**. This controller has a 1.5m (5') long harness terminated with a 4 pin female Deutsch plug.
- 1x12V/24V power lead part number **TC-000012**.

The controller plugs into the extension harness and the extension harness plugs into the **Deutsch plug** on the motor harness. The motor harness part number **DM-000021** is connected inside the hood to the hydraulic motor (at the factory). On the harness of the 2 Speed controller and approximately 70mm (3") from the Deutsch Plug are two leads with a 2-pin plug on each lead . The male plug is tagged showing "SUPPLY 12V/24V" and is the main point where power is supplied to the 2 Speed system. The other plastic 2-pin plug is a female plug that is tagged "**Remote**". It is this plug that an optional 2 Speed joystick mounted toggle switch part number **DM-000026** or Floor mounted dipswitch part number **DM-000030** can be plugged into (see illustration on the following page).

### Operation of the 2 Speed

- The speed controller (mounted in the excavator cab) is a 2 Speed unit. This allows the operator to select the optimum speed required for drilling, core barrelling or applying screw pylons into the terrain.
- **HIGH Speed** is Low Torque - **LOW Speed** is High Torque (see the torque chart supplied with your drive unit to read, output RPM and corresponding torque at an applied hydraulic pressure).

# 12 2 Speed Installations-Electrics

## 2 Speed Electrical Layout for Drives Used on Excavators, Telehandlers, and Backhoes

### ALL PURCHASED PD 2-SPEED DRIVES INCLUDE

- 3m (10ft) motor harness from drive unit (DM-000021)

\*Boom extension harness, in cab controller with cigarette lighter and power supply sold as separate kits to suit excavator sizes (1)

\*Optional Joystick controls and foot controls sold separately (2)

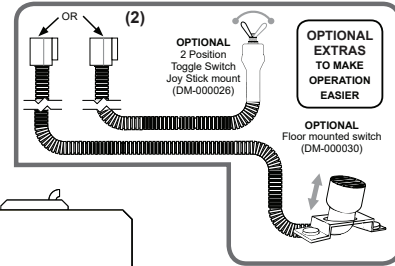
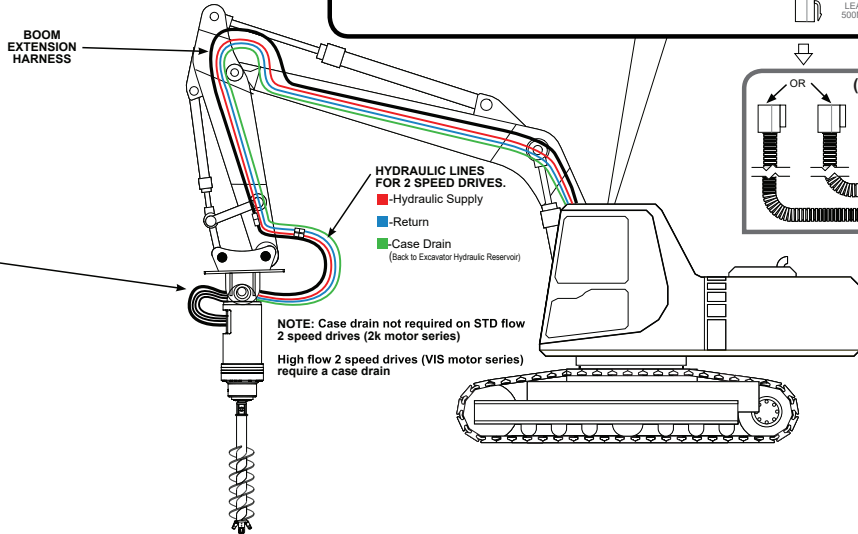
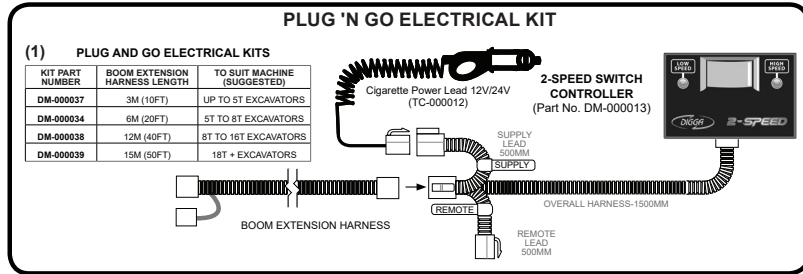

## 12 2 Speed Installations-Electrics

### Connecting the 2 Speed Harness to a Skid Steer Loader

The drive unit is connected to the two speed controller (mounted in the cab) and connection can be done using either of the two options below:

- Direct connection to the loader attachment service plug (optional 8-pin or 14-pin adaptor). In this option depending what service plug the host machine is fitted with (8-pin or 14-pin), the motor harness part number **DM-000021** will take an 8-pin adaptor lead part number **DM-000032** or 14-pin terminated adaptor lead part number **EC-000241**. The 14-pin plug will have to be assembled & pinout configured to suit the customer's machine.

OR

- Connecting using the Plug 'n Go Kit part number **DM-000034** comprising a cab controller, power lead and 6m (20') boom extension harness (optional).

### Operation of the 2 Speed

- The 2 Speed Planetary drive unit range is manufactured using either EATON 2K, 6K or EATON VIS or Linde hydraulic motors.
- The speed controller (mounted in the cab) is only used on the Eaton powered drive units. This allows the operator to select the optimum speed required for drilling, core barrelling or applying screw pylons into the terrain.
- **HIGH Speed** is Low Torque - **LOW Speed** is High Torque (see the torque chart supplied with your drive unit to read, output RPM and corresponding torque at an applied hydraulic pressure).

# 12 2 Speed Installations-Electrics

## 2 Speed Electrical Layout for PD Drives Used on Skid Steer Loaders Fitted With Service Plug

### ALL PURCHASED 2-SPEED DRIVES INCLUDE

- 3m (10ft) harness from drive unit with 2 pin Deutsch plug (DM-000021)
- You will need to order an additional harness to fit your machine service plug. See table bottom right of page.

### HYDRAULIC LINES FOR 2 SPEED DRIVES.

- -Hydraulic Supply
  - -Return
  - -Electrical Harness
  - -Case Drain \*
- (Back to Hydraulic Reservoir)

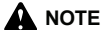

### NOTE

WHEN USING A 2 SPEED DRIVE WHICH IS POWERED BY AN Eaton VHS HYDRAULIC MOTOR, THE CASE DRAIN HOSE MUST BE CONNECTED.

### SERVICE PLUG INFORMATION

A SERVICE PLUG IS AN ELECTRICAL PLUG ON THE FRONT OF SOME SKID STEER LOADERS WHICH IS USED TO ENABLE THE ELECTRICAL FUNCTIONS OF AN ATTACHMENT TO BE CONTROLLED VIA THE MACHINES JOYSTICKS.

THE PLUG CAN COME IN 7, 8 OR A 14 PIN CONFIGURATION DEPENDING ON THE BRAND OF MACHINE. THE TABLE TO THE RIGHT SHOWS WHICH CONVERSION KIT IS REQUIRED FOR WHICH MACHINE.

AS MACHINE MANUFACTURERS SET UP THEIR PINS DIFFERENTLY AND OPERATORS HAVE THEIR OWN PREFERENCES ON HOW THEY LIKE THEIR JOYSTICKS TO WORK DIGGA DOES NOT PRE-WIRE THE PLUGS. THE CUSTOMER WILL NEED TO DO THIS. THE PROCESS IS RELATIVELY SIMPLE AS WE SUPPLY THE PARTS AND INSTRUCTIONS ON HOW TO COMPLETE.

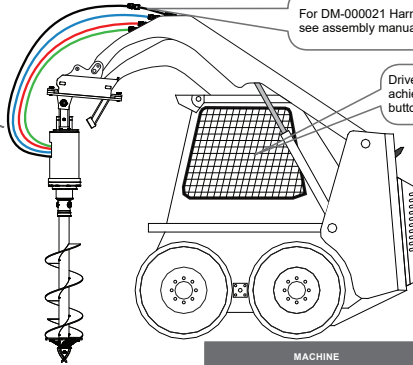

For DM-000021 Harness conversion to 14 Pin Plug, see assembly manual part No. PM-000093

Drive unit speed selection achieved by using appropriate buttons on the machine joystick.

### OPTIONAL ADAPTOR HARNESS

#### DM-000032 INCLUDES

- 2 PIN TO 8 PIN Adaptor WHICH CONNECTS DIRECTLY INTO SUPPLIED HARNESS (DM-000021)

### OPTIONAL ADAPTOR HARNESS KIT

#### EC-000241 INCLUDES

- 2-PIN TO 14-PIN Adaptor HARNESS
- ELECTRONIC CIRCUIT TESTER
- INSTRUCTIONS HOW TO CONNECT THE 14-PIN PLUG TO THE ADAPTOR HARNESS.

MACHINE	ADAPTOR HARNESS REQUIRED (FOR 8-PIN ON MACHINE)	ADAPTOR HARNESS KIT REQUIRED (TO CONVERT TO 14-PIN PLUG FOR MACHINE)
ASV	DM-000032 (optional)	N/A
Bobcat (USING 14 PIN)	N/A	EC-000241 (optional)
Bobcat (USING 7 PIN)	Please contact Bobcat <b>QR</b> purchase Plug and Go Kit to bypass service plug (DM-000034)	
CASE (Pre 09/01/01)	DM-000032 (optional)	N/A
CASE (Post 09/01/01)	N/A	EC-000241 (optional)
CASE (400 series)	N/A	EC-000241 (optional)
CAT (pre 2014)	DM-000032 (optional)	N/A
CAT (D-series)	N/A	EC-000241 (optional)
GEHL	N/A	EC-000241 (optional)
JCB	N/A	EC-000241 (optional)
John Deere "EH"	N/A	EC-000241 (optional)
Komatsu	DM-000032 (optional)	N/A
Kubota	N/A	EC-000241 (optional)
Mustang	N/A	EC-000241 (optional)
New Holland	N/A	EC-00024 (optional)
Takeuchi	N/A	EC-000241 (optional)
Terex	DM-000032 (optional)	N/A
Volvo	N/A	EC-000241 (optional)



# 12 2 Speed Installations-Electrics

## 2 Speed Electrical Layout for PD Drives Used on Skid Steer Loaders Not Fitted With Service Plug

- ALL PURCHASED 2-SPEED DRIVES INCLUDE**
- 3m (10ft) harness from drive unit with 2 pin Deutsch plug
  - *Optional in cab controller with cigarette lighter, power supply and 6m (20ft) extension harness sold separately (1)*
  - *Optional Joystick controls and foot controls sold separately (2)*

- ALL 2-SPEED DRIVES**
- 3m (10ft) harness with 2 pin male Deutsch plug factory installed in drive unit at time of order
  - Re-order Part Number (DM-000021)

High flow 2 speed drives (VIS motor series) require a case drain to be connected

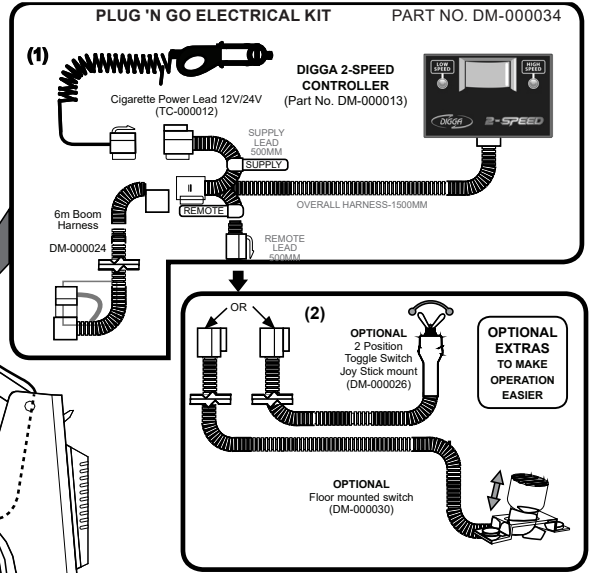
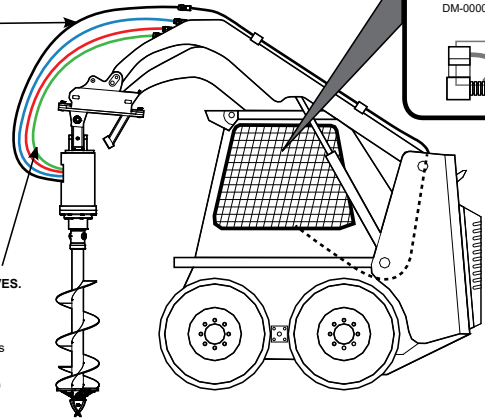
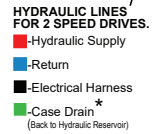

\* **NOTE:** Case drain not required on STD flow 2 speed drives (2k motor series)  
High flow 2 speed drives (VIS motor series) require a case drain to be connected

**NOTE**

WHEN USING A 2 SPEED DRIVE WHICH IS POWERED BY AN EATON VIS HYDRAULIC MOTOR, THE CASE DRAIN HOSE MUST BE CONNECTED.



## 12 2 Speed Installations-Electrics

Below are the layout and schematic drawings of the Speed Controller part number **DM-000013** used on 2 Speed drive units.

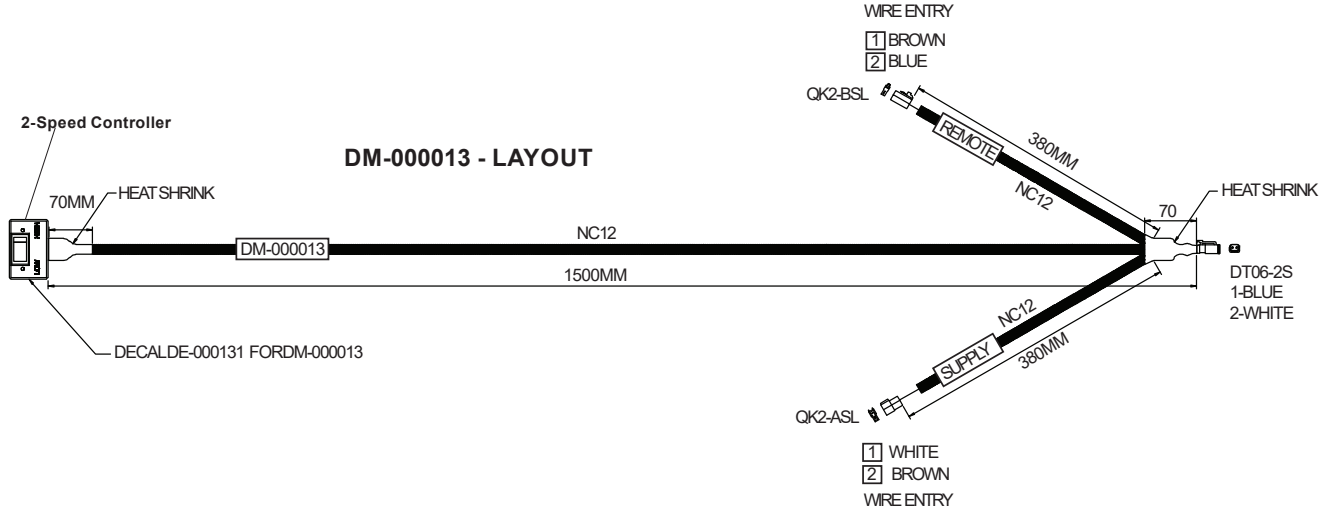

# 12 2 Speed Installations-Electrics

## DM-000013 - Schematic

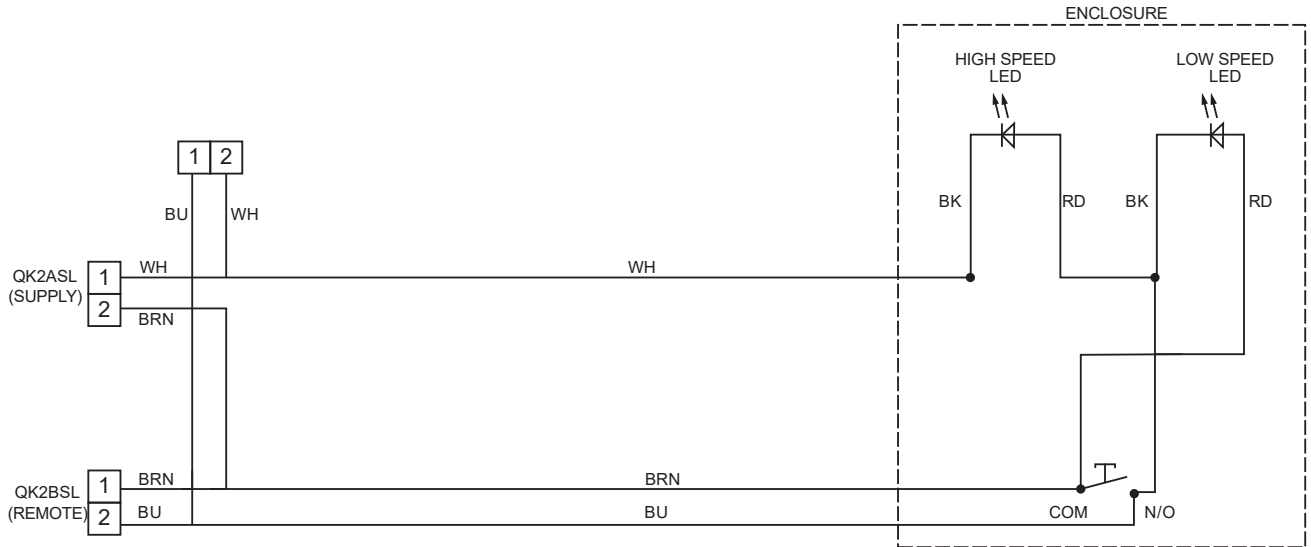

## 13 2 Speed Operating Instructions

### How to Operate the Speed Controllers

#### Digga 2 Speed Controller (For 2 Speed Drive Unit)

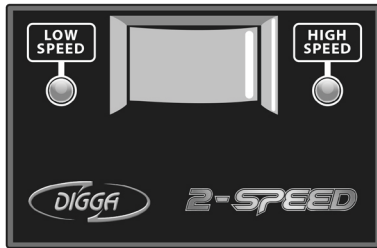

PART NO. DM-000013

1. The 2 Speed controller runs on 2 set speeds, high and low.
2. When power is connected to the 2-pin plug on the controller harness one of the LEDs will illuminate dependant on which position the rocker switch is in, thus indicating that there is power getting to the controller.
3. When the rocker switch is set in the low speed position the LED adjacent will illuminate.
4. When the rocker switch is set in the high speed position the LED adjacent will illuminate.
5. The 2 Speed switch can also operate with a remote joystick-mounted toggle switch part number **DM-000026** or floor mounted remote dip switch part number **DM-000030**.
6. To determine the output shaft rotational speeds when in low speed & high speed refer to the torque chart for your drive unit.
7. If using a remote joystick mounted toggle switch part number **DM-000026** or a floor mounted switch part number **DM-000030** to select the two speed, then the rocker switch on the 2 Speed controller, must be positioned in the low speed position as default.

# 13 2 Speed Operating Instructions

## Digga Remote Switches (Optional)

If using a remote joystick mounted toggle switch part number DM-000026 or a floor mounted switch part number DM-000030 to select the two speed, then the rocker switch on the 2 Speed controller, must be positioned in the low speed position.

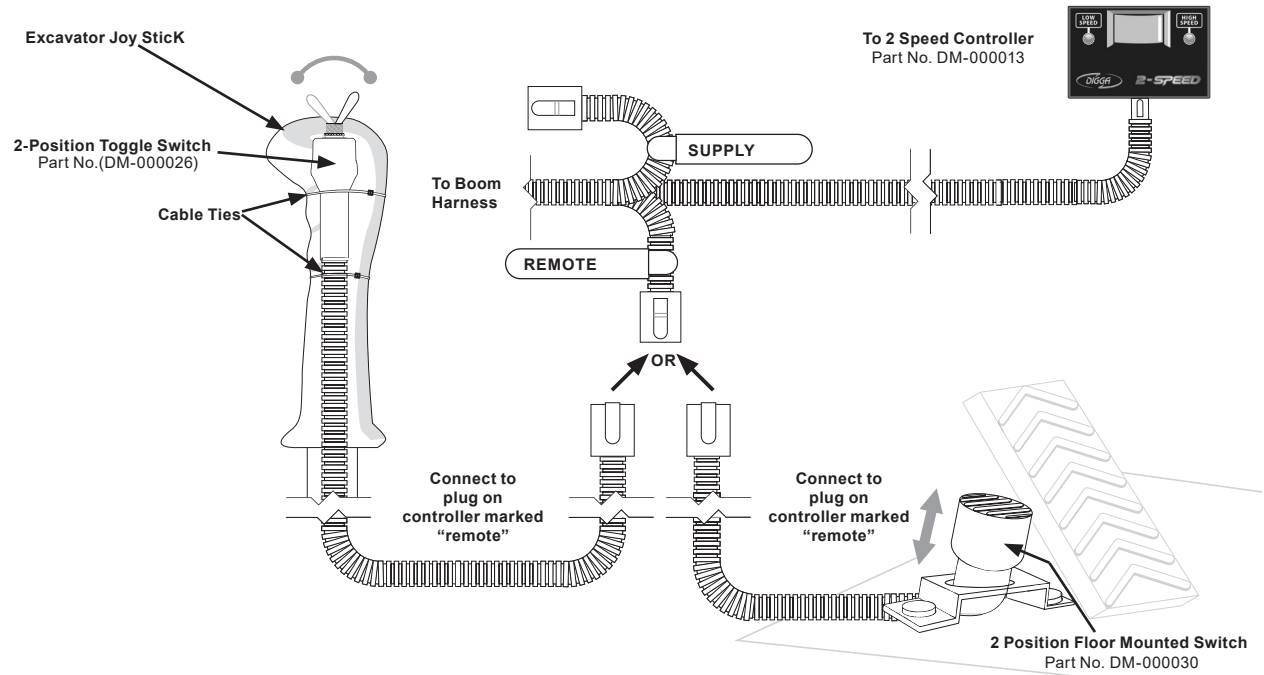

## Oil Change

The gearbox oil capacity is engraved onto the serial tag located on the top of the hood.

### Initial (Bed-in) Oil Change:

- The first oil change must be carried out within the first 50 hours of use under moderate operating conditions. Thereafter, every 500 hours.
- Change the gear oil after the first 30 hours of severe operating conditions\* (i.e. severe ambient temperature conditions of +40°C or below 0°C, when augering, screw piling or core barrelling in hard ground). Thereafter, every 300 hours.

OIL CHANGE SCHEDULE	MODERATE OPERATING CONDITIONS	SEVERE OPERATING CONDITIONS*	PDD (DIRECT DRIVE ONLY)
FIRST OIL CHANGE	Within 3 months <u>OR</u> initial 50 hours of use	Within the first 30 hours of use	Within the first year
2ND OIL CHANGE PLUS SUBSEQUENT OIL CHANGES	After 500 hours or 12 months of use	After 300 hours of use thereafter (Drive requires a major stripdown, inspection and rebuild)	Every 3 years thereafter
GEARBOX OIL: ISO EP 320 Extreme Pressure Mineral Gear Oil AUST/UK - PDD TO PD50			

## NOTE

\*Severe/extreme operating conditions include but not limited to ambient temperature conditions of +40°C (104°F) or below 0°C (32°F), working in hard ground, anchor applications and/or extended and continuous hours of operation. The gearbox oil capacity is engraved onto the serial tag located on the Planetary drive unit.

## 14 Maintenance

### Minimum and maximum gear oil operating temperature for gearboxes

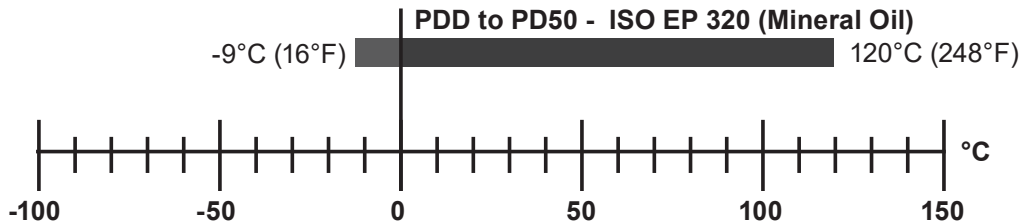

Instructions on how to warm up a drive if operating below 5°C (41°F) can be found in operating instructions section of this manual. Please read and understand these instructions.



### **Procedure to Check the Gearbox Oil Level**

Unfortunately, there is no provision to make a quick visual inspection of the gearbox oil level. There is no window or sightglass provision. The gearbox is filled to the correct level at the factory. Unless there are clear signs of gearbox oil leakage it should not require topping up between scheduled oil changes or services. To check the correct oil level see illustration in maintenance on page 50.

### **Procedure to Drain Gearbox Oil**

It is advisable to replace the output shaft seal at the first oil change as this is the most important oil change to prolong the life of bearings and gears. The reasoning behind this is that whilst bedding in, gearboxes can generate fine metallic contamination. This will find its way to the lowest part of the gearbox and collect in the output seal thus allowing an abrasive paste to wear the output seal and the output shaft. It is advisable that oil changes are performed by a Digga Authorised Service Agent, however it is not always possible for many reasons to get this done by a Dealer however what is important is that the oil is changed at the required intervals.

1. Ensure that the gearbox is stable, secure and safe to work on prior and that the drive unit is vertical and that there is an appropriate sized drip tray to catch the drained oil.
2. Before commencing to drain any oil, check the serial tag of the unit to determine the quantity of oil which the gearbox holds. This will indicate the quantity of oil which has to be replaced into the gearbox and size of bucket needed to contain the oil. Remove the drain plug from the output housing. This will allow the bulk of the gearbox oil to drain out (this will not drain the gearbox entirely). The lower section of the output housing, below the plug will still contain some oil.
3. To drain the remaining oil, lie the drive unit on it's side with the bung hole facing down.
4. Once all oil has been drained follow the procedure on the following page to refill oil.

### **NOTE**

**Remember to consider the environment, state and federal laws relating to disposal of oil. Dumping and spillage of oil onto land, storm water outlets and waterways is illegal. Oil must be disposed of by professional waste disposal or recycle specialists.**

## 14 Maintenance

### Procedure for Changing or Re-filling Gearbox Oil Level

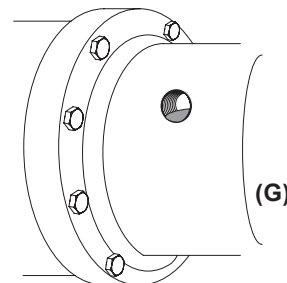
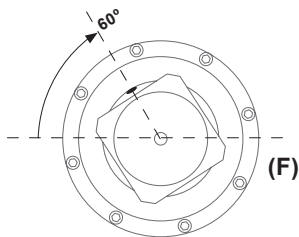
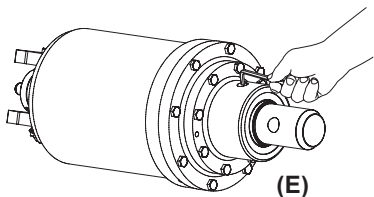

- Lay the drive unit flat on the ground with the oil fill bung facing up. Using an 8mm (0.31") Allen key remove the bung. To drain oil, turn the drive until the hole is facing down. Allow to drain until all oil has been removed **(E)**.
- Rotate the unit until the oil fill hole is sitting between 60° - 70° from horizontal **(F)**.
- Once the filler hole is at approximately 60° the oil should be sitting at the base of the filler hole thread **(G)**.
- If the oil level is too low to reach the thread it should be topped up. Rotate the unit so the filler hole is sitting at the top and add oil. Repeat steps 2 - 4 until you have achieved the correct level.
- Note that the oil takes time to work it's way through the gearbox. Allow time for it to settle once it has reached the bung hole. Then check the level again until all seepage has occurred.

### **NOTE**

If your Planetary drive unit is leaking oil after you have performed the daily checks , consult your local authorised service agent.

# 14 Maintenance

## Gearbox Oil Capacity - Single Speed

DRIVE UNIT	OIL CAPACITY IN LITRES	RECOMMENDED OIL FOR GEARBOX
PDD (Pre Aug 2013)	0.55	ISO EP320 Mineral
PDD (Post Aug 2013) Direct Drive	0.25	ISO EP320 Mineral
PDX	0.55	ISO EP320 Mineral
PDZ3	0.55	ISO EP320 Mineral
PDX3	0.55	ISO EP320 Mineral
PDX2	0.55	ISO EP320 Mineral
PDX1	0.55	ISO EP320 Mineral
PD3	0.55	ISO EP320 Mineral
PD4	0.55	ISO EP320 Mineral
PD5	0.55	ISO EP320 Mineral
PD6	1.45	ISO EP320 Mineral
PD7	1.45	ISO EP320 Mineral
PD8	1.45	ISO EP320 Mineral
PD10	1.45	ISO EP320 Mineral

## Gearbox Oil Capacity - 2 Speed

DRIVE UNIT	OIL CAPACITY IN LITRES	RECOMMENDED OIL FOR GEARBOX
PD4HF	1.45	ISO EP320 Mineral
PD6HF	1.45	ISO EP320 Mineral
PD8HF	1.45	ISO EP320 Mineral
PD10HF	1.45	ISO EP320 Mineral
PDT10HF	1.45	ISO EP320 Mineral
PD12	1.45	ISO EP320 Mineral
PD15	2.85	ISO EP320 Mineral
PD18	2.85	ISO EP320 Mineral
PD22	2.85	ISO EP320 Mineral
PD25	4.8	ISO EP320 Mineral
PD30	4.8	ISO EP320 Mineral
PD40	4.8	ISO EP320 Mineral
PD50	4.8	ISO EP320 Mineral

DRIVE UNIT	OIL CAPACITY IN LITRES	RECOMMENDED OIL FOR GEARBOX
PDT3	0.55	ISO EP320 Mineral
PDT6	1.45	ISO EP320 Mineral
PDT8	1.45	ISO EP320 Mineral
PD18-5-VIS	2.18	ISO EP320 Mineral
PDT4HF	1.45	ISO EP320 Mineral
PDT6HF	1.45	ISO EP320 Mineral
PDT8HF	1.45	ISO EP320 Mineral
PD12-5-VIS	2.2	ISO EP320 Mineral
PDT12	2.2	ISO EP320 Mineral
PDT18	2.85	ISO EP320 Mineral
PDT22	2.85	ISO EP320 Mineral
PDT25	4.8	ISO EP320 Mineral
PDT30	4.8	ISO EP320 Mineral
PDT40	4.8	ISO EP320 Mineral
PDT50	4.8	ISO EP320 Mineral
PD33-7-VIS	4.8	ISO EP320 Mineral

## NOTE

Digga specified ISO EP320 mineral gear oil is specifically for “Extreme Pressure” industrial gearboxes. Oil capacity charts are estimated for a gearbox being filled the first time. When changing the oil, not all oil will drain out, there will always be some residual oil left in the gearbox. Follow the procedure to fill the gearbox, using the oil capacity charts as a guide only.

## 15 Spare Parts

For spare parts of your Planetary drive unit, obtain the serial number off the aluminium serial tag located between the hood ears on the top of the hood of the drive unit. The serial number allows Digga to trace all production and service records. Ensure all service and maintenance is performed by an authorised Digga service agent and all service records are kept. Below is a list of electrical switches, speed controllers and harnesses which are available on all 2 speed planetary drive units. For all other spare parts contact your nearest Digga dealer or Digga Head Office.

### 2 Speed

DESCRIPTION	PART NUMBER
Digga 2 Speed motor harness	DM-000021
Digga 2 Speed controller 12V/24 (optional)	DM-000013
Digga Remote 2 position toggle switch (optional)	DM-000026
Digga floor mounted remote 2 position switch (optional)	DM-000030
2 Speed 3m Extension Harness (optional)	DM-000025
2 Speed 6m Extension Harness (optional)	DM-000024
2 Speed 12m Extension Harness (optional)	DM-000023
2 Speed 15m Extension Harness (optional)	DM-000022
Power Lead (optional)	TC-000012
2 Pin to 8-Pin Adaptor CAT/ASV/TEREX	DM-000032
2 Pin to 14-Pin Adaptor Kit	EC-000241
2 Pin to 14-Pin Adaptor Harness	DM-000041

For further information on spare parts, please contact one of the Digga sales offices shown below, or contact your local authorised Digga dealer.

## DIGGA INTERNATIONAL SALES OFFICES

### ASIA PACIFIC

#### DIGGA HEAD OFFICE - BRISBANE

4 Octal St, Yatala QLD 4207  
Phone: +61 7 3807 3330  
Email: [info@digga.com](mailto:info@digga.com)

#### DIGGA NEW SOUTH WALES

19 Mckay Close,  
Wetherill Park, NSW 2164  
Phone: 1300 2 DIGGA  
Email: [nsw@digga.com](mailto:nsw@digga.com)

#### DIGGA VICTORIA

17-21 Babbage Dr,  
Dandenong, VIC 3175  
Phone: 1300 2 DIGGA  
Email: [vic@digga.com](mailto:vic@digga.com)

Web: [www.digga.com](http://www.digga.com)

### NORTH AMERICA

#### DIGGA NORTH AMERICA

2325 Industrial Parkway SW  
Dyersville IA 52040  
Phone: + 1 563 875 7915  
Email: [infous@digga.com](mailto:infous@digga.com)

Web: [www.diggausa.com](http://www.diggausa.com)

### EUROPE

#### DIGGA EUROPE

Unit 6, Smitham Bridge Road  
Hungerford Trading Estate,  
Hungerford, Berkshire RG17 0QU  
England, United Kingdom  
Phone: +44 (0) 1488 688 550  
Email: [infouk@digga.com](mailto:infouk@digga.com)

Web: [www.diggaeurope.com](http://www.diggaeurope.com)

# 16 Troubleshooting

## Single and 2 Speed Drive Unit

Trouble	Possible Cause	Remedy
No rotation.	Quick release coupler(s) not engaged.	Check quick release coupler(s).
	Quick release coupler(s) faulty.	Replace faulty coupler(s).
	Auxiliary valve on machine faulty.	Refer to machine manual.
	Hydraulic oil tank low.	Fill oil tank to maximum level.
	Hydraulic motor failure.	Contact your DIGGA Dealer*.
	Output shaft bearing failure.	
	Planetary gear failure.	
Machine oil pump faulty.	Refer to machine manual.	
Slow rotation.	Low oil flow.	Check machine specifications.
	Drive unit too large for machine.	Contact your DIGGA Dealer*.
	Hydraulic system too hot.	See hydraulic section.
Hood leaking oil.	Hose(s) or Fitting(s) Leaking.	Tighten or replace.
	Motor 'O' ring failure.	Contact your DIGGA Dealer*.
Output shaft leaking oil.	Oil seal failure.	
	Hydraulic motor failure.	
No torque.	Oil pressure too low.	Check machines specifications.
	Drive unit too small for machine.	Contact your DIGGA Dealer*.
	Hydraulic system too hot.	See hydraulic section.
Grinding or loud noise.	Gearbox failure.	Contact your DIGGA Dealer*.

## 2 Speed Drive Unit

Trouble	Possible Cause	Remedy
The 2 Speed is only operating in low speed.	No power supplied to the controller.	Ensure that the correct voltage is supplied to the controller. The one LED light will illuminate.
		<p><b>NOTE:</b> The 2 Speed drive units can be supplied from DIGGA in either a 12 volt or 24 Volt setup at the factory specific for the excavator which the drive unit is to be used on.</p> <p>Check that the Green LED light is illuminated on the Cigarette Lighter power connector of the power lead.(Cigarette Lighter AKA accessory power connector) There is a 10 Amp Fuse inside this power plug connector. Check the continuity of the fuse if light is out.</p>
	No power supplied to the Planetary Drive.	Check if the LED inside the Hirschmann plug, on the valve block is illuminated, this is located inside the Hood. When power is applied, and the LED is not illuminated. Check the Harness, no light indicates no power is available to the Planetary Drive. The Clear Hirschmann plug with Power LED is a new addition, from June 2022.
	Controller not connected to the extension harness.	Check Extension cables and harnesses to ensure they are plugged in and secure.
	Extension harness not plugged into the motor harness.	Check Extension cables and harnesses to ensure they are plugged in and secure.
Excavator is 24V and drive unit has been setup for a 12V supply.	This may have burnt out the solenoid coil. Contact your DIGGA Dealer.	

\*Do not disassemble drive to assess fault, disassembly without written permission and instructions from Digga will void all warranty.

# 16 Troubleshooting

## Hydraulic System

Trouble	Possible Cause	Remedy
Oil over heating.	Oil pressure too low.	Set relief valve to machine specification.
	Restriction in line.	Inspect and repair.
	Auger continually stalling.	Limit down pressure.
	Drive unit too small.	Contact your Digga dealer.
	Machine too small.	Fit drive unit to larger machine.
	Hydraulic oil tank low.	Fill oil tank to maximum level.
	Insufficient oil capacity.	Fit oil cooler.

## Augers

Trouble	Possible Cause	Remedy
Slow digging speed.	Worn teeth or pilot.	Replace the wear parts.
	Ground too hard.	Contact your Digga dealer.
	Low oil flow.	Check the machine specifications.
	Auger too large for the drive unit.	Fit larger drive unit.
	Machine too small.	Fit drive unit to larger machine.





***HALO***

## **Main function**

The Halo alignment system measures the angle of the drive with respect to plumb. With this measurement, the Halo displays a sequence of colours on a circular LED array that is visible to the machine operator. The LED array changes colour with the angle of the drive, showing 'all green' when very close to plumb (within 1.5°). When the drive is slightly off plumb (by more than 1.5°) the LEDs will change from all green to partially green and red, showing the operator which way to manoeuvre the drive to return to plumb. The operator should move their machine in the direction of the green portion of the LED array.

When the drive is hanging free when the machine is not operational, the LED sequence may appear to be incorrect or 'backwards' when tilting the drive about the hitch. It's not until the drive pivots about the end of the auger/pile that the Halo system will make sense to the operator.

## **Start-up**

Make sure the auger drive is hitched and hanging approx. plumb before connecting the power supply. After connecting the power supply, the auger drive with Halo must be still (not moving) for 30 seconds. During this time you may notice the lights moving even though the drive is still. After 30 seconds, the Halo will have finished the start-up calibration will be showing the correct LED sequences.

## **Powering the Halo**

The Halo system is offered with a variety of power options. The basic version of the Halo is powered by the 12V/24V auxiliary power from the cab (otherwise known as a cigarette socket). The basic version does not include any 'zero' capability or data capability. The Halo can also be powered by a custom built magnetic battery which also features a 'zero' switch for drilling at angles and to increase accuracy for piling applications. The Halo battery can be connected to the system at the boom or in the cab via any combination of Halo extension cables.

## **Limitations**

The Halo uses 6-way sensor fusion to measure the orientation of the drive. Because there is a certain amount of mechanical play between the auger/pile and the drive itself, the operator should be aware of this limitation and that the Halo LED array is displaying the orientation of the drive, not the auger/pile.

The inner workings of the inclinometer are susceptible to heavy vibration and jolting. Whilst a lot of effort and testing has gone into minimising these effects for regular use, drilling into rocky or tough ground will produce 'shocks' to the drive (also felt through the operator) which will temporarily show an incorrect reading of the angle data on the LED array (similar to 'knocking' a spirit level with a hammer whilst taking a reading). If the operator wishes to take an accurate reading to gauge the orientation of the drive, simply stop the rotation of the auger or pile for a brief moment and the system will display a stable reading. If the LED display exhibits erratic behaviour as a result of an impact or vibration, either disconnect the power during this type of use, or disconnect and reconnect the power supply to reset the system.

### **Clearing debris from the LED groove**

Where mud or debris becomes heavily caked into the LED ring groove, do not use force or sharp objects to remove the debris. If pressure washing and normal cleaning methods do not prevail, carefully use a blunt implement encourage any caked on mud to dislodge. Do not under any circumstances use a hammer or any other device to chisel at the LED ring.

## **FAQ**

### **What do the various colour arrays signify?**

Solid green: within 1.5° from plumb

Partially green, partially red: more than 1.5° from plumb, move your controls to chase the green portion to return to plumb.

### **How long does the battery last for?**

Through normal use, approx. 8-9 hours. Spare batteries and charges are available for purchase. Leaving the Halo turned on whilst display 'all green' will use the battery at a slightly faster rate. Once the power has been depleted, the LEDs will turn off and the battery will need to be recharged.

### **Travelling with the battery:**

Customers may treat the Halo battery in the same way you would a cordless drill battery. The battery meets IEC 62133:2012 (Second edition) specifications for safety as a portable sealed battery. This battery standard enables the batteries to fly however each airline has their own specific rules so it is wise to check prior to planning travel.

### **Spare batteries:**

Spare batteries are readily available from Digga for 'hot swapping' on long days or as a backup.

### **Alternative chargers:**

Use of an alternative charger is strictly prohibited and could result in a dangerous hardware failure. Only use a certified Halo charger.

### **Can the drive be used in wet conditions?**

The Halo electronics are designed to run reliably in any drilling conditions, including down an auger hole that's filled with water. When recharging the battery it is recommended to allow the connectors to completely dry before connecting the charger or reconnecting the Halo to prevent any galvanic corrosion if a small amount of moisture has leaked passed the seals. Do not manually dry the electrical terminals with an implement.

### **How accurate is the Halo?**

When utilising the zero switch and 'zeroing' the Halo against an accurate level, the repeatability of the Halo is  $\pm 0.25^\circ$ .

### **Battery placement (for customers with the Halo magnetic battery)**

The battery features strong magnets within the case that will help to attach the battery to the hitch or boom where it is out of the way. Through vibration and regular use, the battery may move about so it's recommended to place it somewhere where it can butt up against an edge to reduce the amount of movement. Alternatively the operator can also cable tie the battery in place however this will make recharging less convenient.

It's best to place the battery somewhere on the machine so that the power cable cannot be crushed through normal use. The battery and Halo system is protected from short circuit however the power cables are not repairable and will need to be replaced in the event of damage. The cables are rugged by design however it's not a good idea to let the battery hang from the power cable at any point. If the battery is dislodged from the boom or hitch during use, stop immediately and change the location of the battery or cable tie the battery in place to avoid this happening repeatedly.

## **Zero switch (for customers with the Halo magnetic battery)**

The battery is equipped with a zero function which zero's out the inclination. This can be useful if drilling on an incline that is not plumb, such as inclined piers. It's also useful if a greater accuracy is required. A colour sequence displays on the Halo LED ring to give the operator an indication of zero mode. Press the switch to activate zero mode and the Halo LEDs will all flash blue for a moment. When in zero mode, the middle section of the LED array will illuminate blue. To exit zero mode, press the switch again and the LEDs will all flash white for a moment. Now the middle section of the LED array will display white. It's not recommended to zero the Halo beyond 30° from plumb. The zero switch is of a type which has no mechanical movement. This improves the longevity and reliability of the switch. The lack of noticeable movement does not indicate a fault. To activate the switch, tap and press heavily on the top of the switch and observe the LED changes.

## **Charging the battery**

The battery should be charged after every use and at least once every 3 months if not used regularly. This type of lithium battery will have a prolonged life if charged after or before each use. Make sure the battery is never left hanging by the charger cord as this could result in failure over time. The charger should only be used indoors and out of direct sunlight in a cool, dry place (similar to where and how you would charge a mobile phone). The battery should be charged fully before first use. Batteries are shipped at 30% charge as per recommended practise.

## **Best practices**

When connecting power to the Halo, allow the drive to hang stationary (no movement) for 30 seconds for the system to perform a start-up calibration. If this isn't permitted, the calibration may not complete.

While HALO is not in use, while being transported or stored, place the yellow lead-in cable into the hood to protect it from potential crushing damage. Ensure cable is connected to the hood or hoses before placing into the hood to avoid cable from falling out of reach.

## COMPONENTS LIST

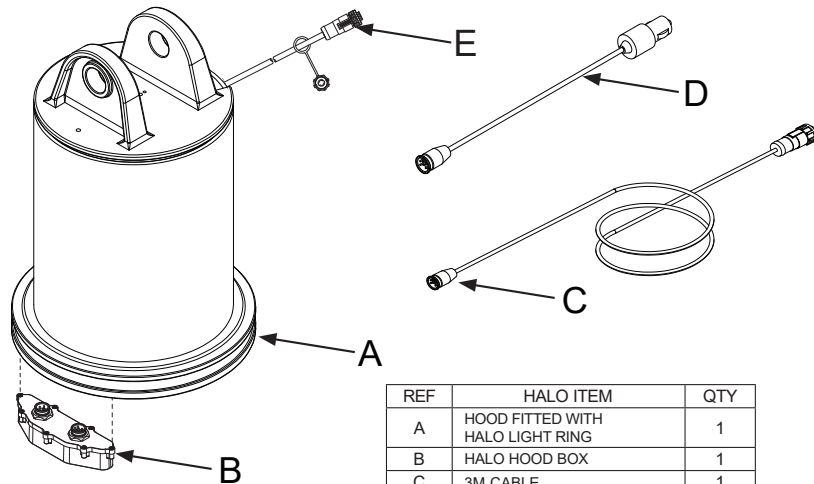

REF	HALO ITEM	QTY
A	HOOD FITTED WITH HALO LIGHT RING	1
B	HALO HOOD BOX	1
C	3M CABLE	1
D	CIGARETTE LIGHTER PLUG	1
E	LEAD IN CABLE	1

## SERVICING AND DISASSEMBLY NOTES

When disassembling any part of the Halo, please ensure all parts are reassembled in the same order and orientation to avoid any problems. When lowering the hood onto the drive, make sure no cables are crushed in the process. Once reinstalled, make sure no cables exiting the hood can be crushed. The Power cable needs to have 400-500mm slack inside the hood to ensure it does not strain on the hood box connector. Make sure a cable tie is used to secure this length of slack in the Power cable inside the hood by tying the power cable firmly to one of the hydraulic hoses (with the slack inside the hood). The power cable should then be re-wrapped in the black spiral wrap to protect from damage in use.

## HALO TROUBLE SHOOTING

Reference	Problem observed	Possible reason	Troubleshooting steps
1	Halo shows flickering readings	Drilling environment	When drilling in hard or rocky ground, the inclination readings can be prone to misreading or abnormal behaviour. The inclination sensor is sensitive and much like hitting a spirit level with a hammer, drilling in hard or rocky ground can cause issues with the Halo system. If the readings are not useful in such applications, either the operator can bring the drive to a halt to take a valid reading from the Halo at rest, or disconnect the Halo whilst that ground is making it difficult to produce a useful reading.
2	Halo freezes	Drilling environment	If the Halo sensor becomes overwhelmed with erratic sensor data from rough ground, it's possible for the instruments that senses the inclination to enter an error state. Restarting the Halo will remove this error state.
3	Halo shows incorrect readings	Zero mode is active (using the Halo battery)	In normal drilling mode, the Halo will display white in the centre of the LED array when the green and red array show. If the centre shows blue, the zero mode is activated. To return to normal drilling mode, either press the zero mode button again and the LEDs will flash all white for a moment, or turn the Halo off and on by unplugging the battery.
4	Halo shows incorrect Readings	Start-up calibration incomplete	Make sure the auger drive is hitched and hanging approx. plumb before connecting the battery. After connecting the battery, the drive with the Halo must be still for 30 seconds. During this time you may notice the lights moving even though the drive is still. After 30 seconds, the Halo will have finished the start-up calibration will be showing the correct LED sequences.
5	Halo doesn't turn on	Faulty 12V supply	Check that the red light is glowing on the cab cable (12V cigarette plug). If the red light isn't displaying, the 12V socket may be faulty.
6	Halo doesn't turn on	Damaged cable extension	Check for any damage to any exposed cables. Cable damage could indicate a discontinuity and require a replacement.

## HALO TROUBLE SHOOTING

Reference	Problem observed	Possible reason	Troubleshooting steps
7	Halo doesn't turn on	Damaged lead in cable (yellow tail)	The lead in cable with the yellow tail connects the Halo hood box to the cable system outside of the hood. If this cable is damaged it will require a replacement to be installed by removing the hood which needs to be performed by a qualified Digga service technician.
8	Halo doesn't turn on	Damaged or failed Halo component	If the Halo hood box or LED ring is damaged or has experienced a failure and requires a replacement, please contact Digga service for assistance.





# Warranty Statement

## **PD & Drive Units - Used for Drilling Application**

Motor - Warranty up to 3 years compliance with service Interval information and subject to manufacturers inspection.

Gearbox - Warranty up to 5 years subject to compliance with service Interval information and manufacturers inspection.

## **PD Drive Units - Used for Anchor Application PD4HF - PD50 fitted with ECV (Swoosh)**

Motor - Warranty up to 2 years compliance with service Interval information and subject to manufacturers inspection.

Gearbox - Warranty up to 3 years subject to manufacturers inspection.

## **PD Drive Units - Used for Anchoring Application up to 16,000Nm without ECV (Swoosh)**

Motor - Warranty up to 1 years subject to compliance with service Interval information and manufacturers inspection.

Gearbox - Warranty up to 2 years subject to compliance with service Interval information and manufacturers inspection.

## **PD Drive Units - Used for Anchoring Application over 16,000Nm not fitted with ECV (Swoosh)**

Motor - No warranty.

Gearbox - No warranty.

All new Digga products are warranted to be free from defects in materials or workmanship for a period of twelve (12) months from date of original purchase, which may cause failure under normal usage and service when used for the purpose intended. In the event of failure (excluding cable, ground engaging parts such as sprockets, digging chain, bearings, teeth, tamping and demolition heads, blade cutting edges, pilot bits, auger teeth, auger heads ). If after examination, Digga determines failure was due to defective material and/or workmanship, parts only will be repaired or replaced. Digga may request defective product or products be returned prepaid to them for inspection at their place of business or to a location specified by Digga. The warranty will be considered void if the product or any part of the product is modified or repaired in any way not expressly authorised by Digga, or if closed components are disassembled prior to return. Closed components include, but are not limited to: Gearboxes, Hydraulic pumps, Motors, Cylinders and Actuators. Any goods returned to Digga by the customer under warranty or repair must have all freight charges prepaid for on the customers account. Any claims under this warranty must be made within fifteen (15) days after the Buyer learns of the facts upon which such claim is based. All claims not made in writing and received by Digga outside the time period specified above shall be deemed waived.

## Warranty Statement (Continued)

### **Damage or failure through operator abuse or negligence voids warranty.**

This warranty is in lieu of all other warranties expressed or implied and there are no warranties of merchantability or of fitness for a particular purpose. In no event shall Digga be liable for consequential or special damage. Digga's liability for any and all losses and damages to buyer, resulting from any cause whatsoever, including Digga's negligence, irrespective of whether such defects are discoverable or latent, shall in no event exceed the purchase price of the particular products with respect to which losses or damages are claimed, or, at the election of Digga, the repair or replacement of defective or damaged products.

**If the first oil change and subsequent oil changes are found to have not been performed at the correct specified time, and results in premature gearbox failure during the warranty period, the warranty will be voided.**



Available through

**EARTHMOVING  
WAREHOUSE**

[earthmovingwarehouse.com.au](http://earthmovingwarehouse.com.au)

0459927346 (0459 WAREHOUSE)  
Shed C1/C2 194 Zillmere Road,  
Boondall Brisbane 4034  
QLD

PM-000251