



PALLET FORKS - FOR MULTIFIT SKID STEER LOADERS

OPERATORS MANUAL

**EARTHMOVING
WAREHOUSE**

PM-000135-E

Congratulations on the purchase of your new DIGGA Pallet Fork! This product was carefully designed and manufactured to give you years of dependable service. To keep it running efficiently please read the instructions in the manual to keep it in top working condition.

Be sure to observe all safety precautions and maintenance procedures as described in this manual.

No responsibility will be taken by Digga for any omissions or errors in this manual as all data is correct at time of print, however Digga reserve the right to revise this manual without further notice.

The Pallet Fork has multilift mounting. Please contact your DIGGA dealer for any further information pertaining to this product or for further information on other Digga products.

ABOUT THIS MANUAL

This manual has been designed to help you do a better, safer job. **Read this manual carefully and become familiar with its contents.** Remember; never let anyone operate this unit without reading the "Safety Precautions" and "Operating Instructions" sections of this manual. Unless noted otherwise, right and left sides are determined from the position of the operator when behind the product facing forward.

Manufacturer DIGGA Australia Pty Ltd <small>ABN 88 010 443 875</small>		CE	MADE IN AUSTRALIA DPE-000288
Date of manufacture:	<input type="text"/>		
Model No.:	PF		
Serial No.:	<input type="text"/>		
DESIGN CAPACITY OF THIS ATTACHMENT IS IN ACCORDANCE WITH ISO 2330:2002 AND HAVING A RATING OF: <input type="text"/> kg x 500mm centres			
Mass of attachment (approximate)		<input type="text"/>	kg.
www.digga.com		Ph: +61 7 3807 3330	

YOUR DIGGA PALLET FORK IS A USER SERVICEABLE PART.

IMPORTANT: WHEN SERVICING OR ASSEMBLING YOUR PRODUCT, REMEMBER TO USE ONLY GENUINE DIGGA REPLACEMENT PARTS. SUBSTITUTE PARTS MAY NOT MEET THE STANDARDS REQUIRED FOR SAFE, DEPENDABLE OPERATION. USE OF NON GENUINE DIGGA PARTS WILL VOID WARRANTY AND DIGGA WILL ACCEPT NO LIABILITY WHATSOEVER FOR CONSEQUENTIAL OR SPECIAL DAMAGES.

MODEL _____

SERIAL NUMBER _____

DATE PURCHASED _____

The parts department needs this information to insure accurate parts can be sent to the authorised service agent.

2 TABLE OF CONTENTS

	PAGE
1 TO THE PURCHASER	3
2 TABLE OF CONTENTS	4
3 PREPARATIONFOR USE	5
4 INSTALLATION AND OPERATING INSTRUCTIONS	6
5 MAINTENANCE	13
6 SPARE PARTS	13
7 SAFETY STICKER LOCATION	14
8 SAFETY PRECAUTIONS	15
9 SAFETY-WORKING WITH THE ATTACHMENT	18
10 TECHNICAL SPECIFICATIONS	18
11 WARRANTY	19

MODELS COVERED IN THIS MANUAL

PALLET FORK MULTIFIT MODELS

PF-001130-1500

PF-001130-1800

3 PREPARATION FOR USE

To avoid any inconvenience before operation, please check that you have received the following items which you have ordered.

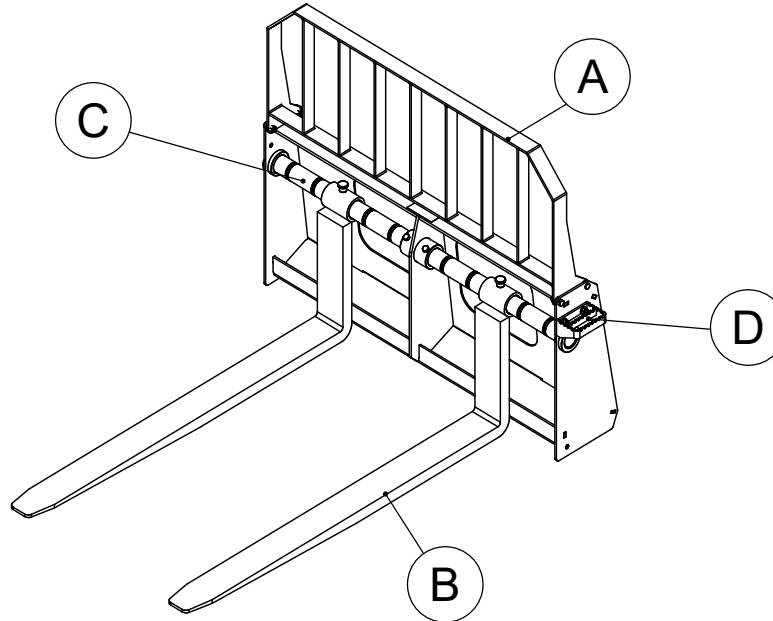

PALLET FORK		
REF	DESCRIPTION	QTY
A	Pallet Fork Frame	1
B	Pallet Fork Tynes	2
C	Tyne Bars	2
D	Step	1

ASSEMBLING PALLET FORKS



Slide packaging upwards and remove.

 Ensure packaging is disposed of in accordance with federal, state and local regulations.



Cut straps

 Ensure pallet fork frame is sitting stable on timber frame before cutting straps.



Place frame on ground

 NOTE: This pallet fork requires appropriate material handling equipment. Do not manually attempt to lift.

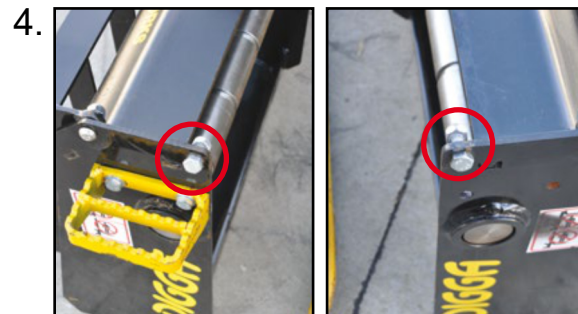

Remove the front nuts and bolts from both sides of the frame.

4 INSTALLATION AND OPERATING INSTRUCTIONS



Swing the safety guard upright.

 Ensure hands are well clear of pinch point.

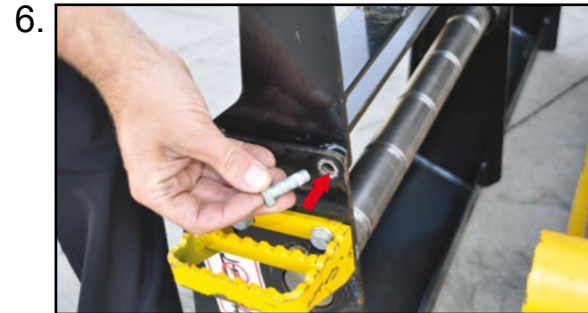

Align the holes of the frame with the holes of the safety guard and tighten bolts.



Unscrew the bolts holding the 2 tyne rods in place.



Slide the tyne rods outwards just enough so that the tynes can be fitted.

4 INSTALLATION AND OPERATING INSTRUCTIONS



Move the first tyne in place and insert the rod through the tyne hole.

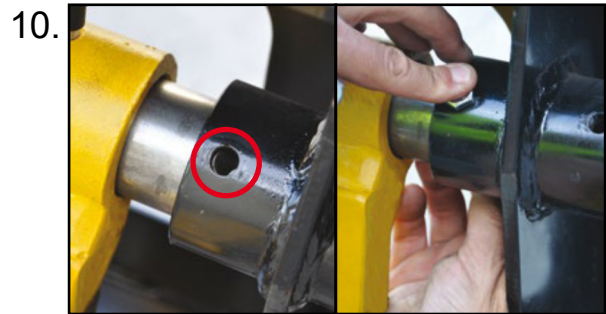

Align the tyne rod hole and the hole located on the frame and tighten the bolt. Ensure the bolt head is facing upwards. **See Figure 1**

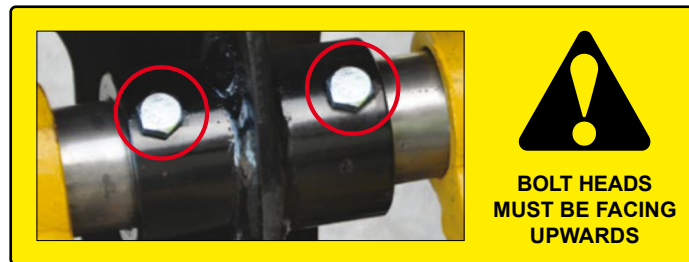
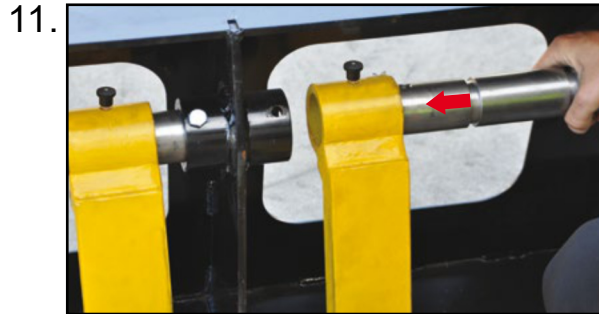
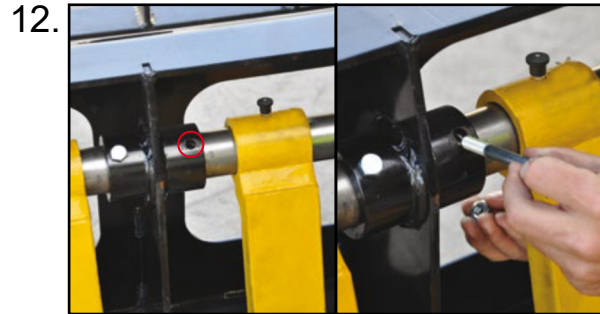

Figure 1



Move the second tyne into place and insert the rod through the tyne hole.



Align the tyne rod hole with the hole located on the frame and tighten bolt. Ensure the bolt head is facing upwards. **See Figure 1 on previous page.**

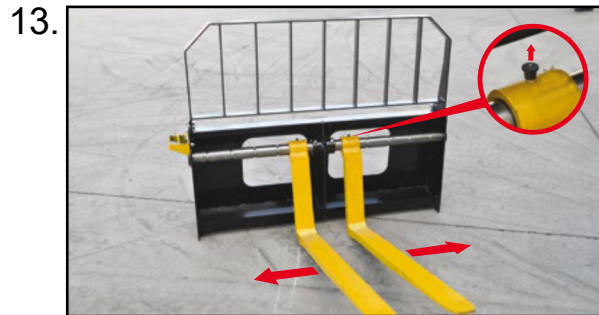

Adjust the tynes to desired width by lifting the black locking pins on top of the tynes and sliding them in to place. **Refer to page 11 for correct methods of adjusting tynes.**



4 INSTALLATION AND OPERATING INSTRUCTIONS



SAFETY FIRST!! READ AND UNDERSTAND THE SAFETY INSTRUCTIONS BEFORE MOVING ANY LOADS

1. Remove bucket as per Machine Operators Manual.
2. Pick up pallet fork as you would your Loader Bucket and ensure that it is securely attached to your machine as per your machine manual.
3. Adjust tyne with to suit pallet width by lifting locking nut and sliding tyne into position (see fig 1 page 11). Ensure locking nut drops into locating groove.
4. If load is picked up correctly Tynes should exit the rear of the load.
5. Once pallet is positioned correctly on Tynes (see page 4 for safe working load positions), tilt frame back and lift loader arms to ensure load is fully engaged and clear from the ground.
6. Do not apply load to one tyne as this will cause damage. The attachment is designed to spread load evenly over both tynes working in parallel. N.B. Tynes are matched and serial coded as a pair, any damage to an individual tyne will require a new pair to be purchased. Tynes are not sold separately.
7. Lifting capacity of attachment is rated at 600mm centres combined (see page 4 for safe working load positions). Lift capacity reduces significantly the further away the load is down the tyne.
8. Lifting capacity of attachment is rated at 600mm centres combined. Do not lift with one tyne. Lift capacity reduces significantly the further away the load is.



DO NOT EXCEED LIFTING CAPACITY OF MACHINE. PALLET FORK AND FRAME COMBINED FORM PART OF THE MACHINES SAFE WORKING LOAD (SWL) REFER TO OPERATORS MANUAL.



SAFETY FIRST!! READ AND UNDERSTAND THE SAFETY INSTRUCTIONS BEFORE MOVEING ANY LOADS.



FAILURE TO OBEY THE FOLLOWING PROCEDURES COULD RESULT IN DEATH OR SERIOUS INJURY.



UNDER NO CIRCUMSTANCES ALLOW PASSENGERS TO RIDE ON THE PALLET FORKS.



BE ALERT TO OTHERS IN THE WORK AREA. BE SURE OTHERS KNOW WHEN AND WHERE YOU WILL BE WORKING. MAKE SURE NO ONE IS BEHIND EQUIPMENT OR WITHIN 15 METRES OF IT OPERATING.

- Complete a daily inspection prior to operating pallet fork.
- Always travel at a low speed.
- Always carry load as low as possible.

HOW TO ADJUST TYNE WIDTH

There are 2 methods of adjusting tyne width. When adjusting tynes, please place hands in correct position to avoid potential pinching

METHOD 1: Pull locking pin and twist to lock open. Lift the tyne with one hand while pushing the top of the tyne with the palm of your other hand. (FIG 1). Top hand should be positioned at the top of the tyne to ensure it is well away from the bottom rail. (FIG4) Twist locking pin to lock position and move tyne until locking pin falls into tyne rod groove.



(FIG 1)

METHOD 2: Lower the pallet fork so it is just above the ground. Pull locking pin and twist to lock open and kick tyne into position using the heel of your foot (FIG 2). Always ensure you are using appropriate safety footwear before attempting to adjust tynes in this method. Twist locking pin to lock position and move tyne until locking pin falls into tyne rod groove.



(FIG 2)

**WARNING**

DO NOT ATTEMPT TO REPOSITION THE TYNES WITH HANDS AND FINGERS WRAPPED AROUND THE TYNE (FIG 3 AND 4). ALWAYS USE THE PALM OF YOUR HAND TO AVOID POTENTIAL PINCHING (FIG 5)



(FIG 3)



(FIG 4)



(FIG 5)

4 INSTALLATION AND OPERATING INSTRUCTIONS

SAFE WORKING LOAD (PER PAIR)

PF-001130-1500

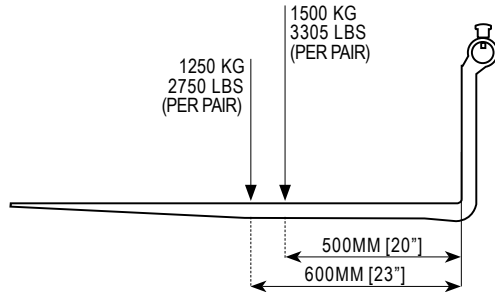

PF-001130-1800

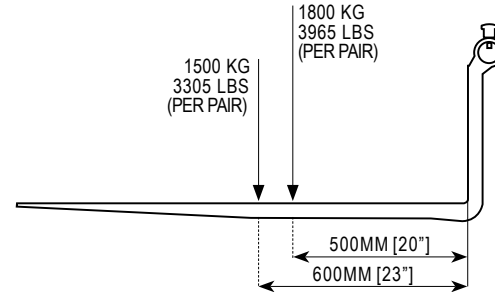

REMOVAL AND STORAGE

1. Set the attachment on the level ground.
2. Disengage the machine lock pins.
3. Make sure that the lift arm is lowered and in contact with the loader frame.
4. Roll the attachment mechanism forward and slowly back up until the attachment is free from the machine.
5. Remove and store the attachment in a dry and protected place. Leaving the Pallet Fork outside will materially shorten its life.

WHEN ATTACHMENTS NOT ON PARENT MACHINE:

It is a requirement of the Australian Work place Health and Safety act 1995 that safe systems of work are employed when handling any attachments. Complete compliance with Workplace Health and Safety issues is compulsory and all due care and attention must be observed at all times in any method of moving, transporting or storing any such device when not attached to a parent machine. We recommend attachments are well secured when being moved or in transit and furthermore prior to moving, storing, loading/unloading or parking it is suggested that the attachment is strapped/secured to a pallet or enclosed in a suitable container to minimise any movement or loss of the load during such activity. NO responsibility for loss or damage to persons or property in any regard can be attributed to Digga.

TRANSPORTING THE ATTACHMENT

1. Follow all federal, state and local regulations when transporting the unit on public roads.
2. Use extra care when loading or unloading the machine onto a vehicle.



SAFETY FIRST!! READ AND UNDERSTAND THE SAFETY INSTRUCTIONS BEFORE BEGINNING ANY PALLET FORK MAINTENANCE.

BEFORE FIRST USE

- Inspect the attachment for shipping damage. If damage does exist, do not operate until the damaged parts have been replaced or repaired.

BEFORE EACH USE

- Make sure that all nuts and bolts are in place and properly tightened.
- Make sure that all other fasteners are in place and are performing their specified function.
- Make sure that all safety signs are in place, are clean, and are legible. (SEE THE SAFETY SIGN SECTION ON PAGE 14)
- Replace any damaged parts and excessively worn parts.

6 SPARE PARTS

For further information on spare parts please contact one of the Digga sales office below your closest authorised Digga Dealer.

ASIA PACIFIC

DIGGA HEAD OFFICE - BRISBANE

4 Octal St, Yatala QLD 4207

PH: (07) 3807 3330

EMAIL: info@digga.com

DIGGA NEW SOUTH WALES

19 Mckay Close,
Wetherill Park, NSW 2164

PH: 1300 2 DIGGA

EMAIL: nsw@digga.com

DIGGA VICTORIA

17-21 Babbage Dr,
Dandenong, VIC 3175

PH: 1300 2 DIGGA

EMAIL: vic@digga.com

WEB: www.digga.com

NORTH AMERICA

DIGGA NORTH AMERICA

2325 Industrial Parkway SW
Dyersville IA 52040

PH: + 1 563 875 7915

WEB: www.diggausa.com

EMAIL: info@diggausa.com

EUROPE

DIGGA EUROPE

Unit 6, Smitham Bridge Road
Hungerford Trading Estate,
Hungerford, Berkshire RG17 0QU
England, United Kingdom

PH: +44 (0) 1488 688 550

WEB: www.digga-europe.com

EMAIL: info@digga-europe.com

PALLET FORKS

PLACEMENT OR REPLACEMENT OF SAFETY SIGNS

1. Clean the area of application with non-flammable solvent, then wash the same area with soap and water.
2. Allow the surface to fully dry.
3. Remove the backing from the safety sign, exposing the adhesive surface.
4. Apply the safety sign to the position shown in the diagram above and smooth out any bubbles.

INSTRUCTIONS

- Keep all safety signs clean and legible.
- Replace all missing, illegible, or damaged safety signs.
- Replacement for parts with safety signs attached must also have safety signs attached.
- Safety signs are available from your dealer or from Digga Australia.

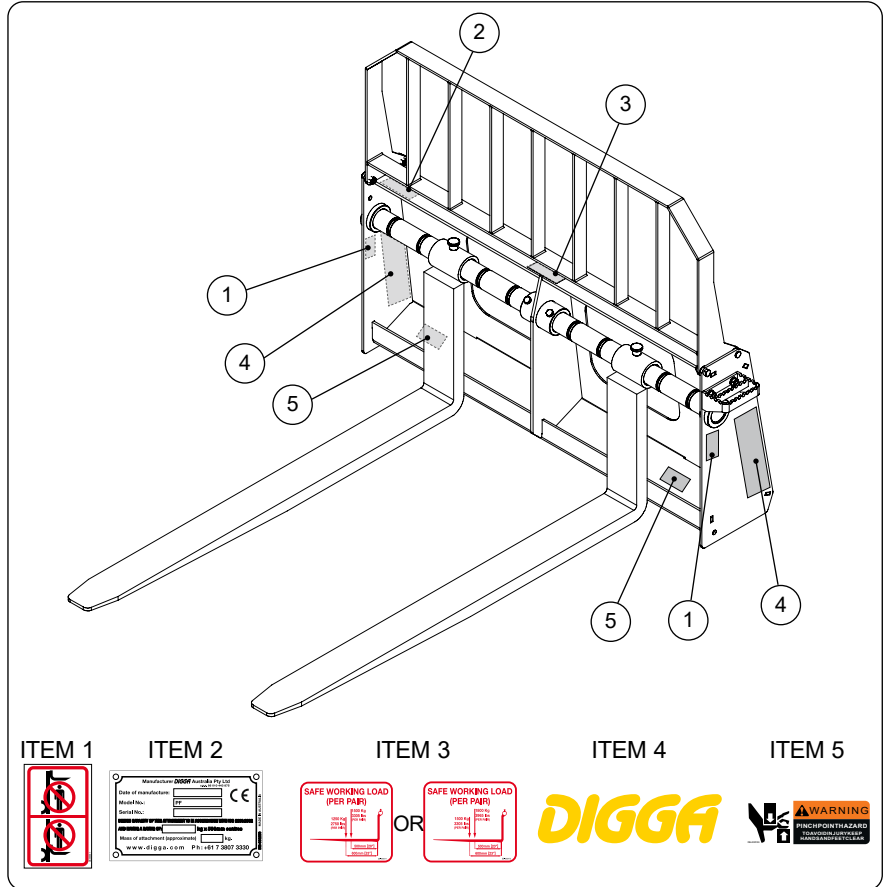

ITEM NO	ORDER CODE	DESCRIPTION	QTY
1	DE-000051	Fork Lift Safety	2
2	DE-000256	Serial Tag	1
3	DE-000471	SWL1500kg	1
	DE-000472	SWL1800kg	1
4	DE-000049	Digga Decal	2
5	DE-000129	Pinch Point Warning	2

ITEM 1



ITEM 2



ITEM 3



ITEM 4



ITEM 5



TAKE NOTE! THIS SAFETY ALERT SYMBOL FOUND THROUGHOUT THIS MANUAL IS USED TO CALL YOUR ATTENTION TO INSTRUCTIONS INVOLVING YOUR PERSONAL SAFETY OR OTHERS. FAILURE TO FOLLOW THESE INSTRUCTIONS CAN RESULT IN INJURY OR DEATH.

THIS SYMBOL MEANS:



**ATTENTION!
BECOME ALERT!
YOUR SAFETY IS INVOLVED!**

SIGNAL WORDS: Note the use of signal words DANGER, WARNING, and CAUTION with the safety messages. The appropriate signal word for each has been selected using the following guidelines:

DANGER: Indicates an imminently hazardous situation, which if not avoided, will result in death or serious injury. This signal word is to be limited to the most extreme situations, **typically for machine components which, for functional purposes, cannot be guarded.**

WARNING: Indicates a potentially hazardous situation, which if not avoided, could result in death or serious injury, and includes hazards that are exposed when guards are removed. It may also be used to alert against unsafe practices.

CAUTION: Indicates a potentially hazardous situation, which if not avoided, may result in minor or moderate injury. It may also be used to alert against unsafe practices.

This section is composed of various warnings and safety tips. **Read and learn all the information in this section before you attempt to use your attachment.** Also read your vehicle owner's manual before using your equipment. This knowledge will help you operate your unit safely. **Do not take this information lightly, it is presented for your benefit and for the benefit of others working around you.**

The "Safety Alert Symbol"  will be used throughout this manual. It will appear with the word **DANGER, WARNING, or CAUTION**, and a safety message pertaining to the specific topic being covered. Take the time to read these messages as you come across them.

TO THE OPERATOR

The primary responsibility for safety with this equipment falls to the operator. Make sure that the equipment is operated only by trained individuals that have read and understand this manual. Don't hurry the learning process or take the unit for granted. It is the skill, care, common sense, and good judgement of the operator that will determine how efficiently and safely the job is performed. Know your equipment before you start. Know its capabilities and how to operate all the controls. Visually inspect your equipment before you start, ensure correct assembly and installation of the attachment and never operate equipment that is not in proper working order. Practice the operation of your new attachment and become familiar with the controls and the way it handles on your machine. If there is any portion of this manual or function you do not understand, contact your local authorized dealer or the manufacturer.

8 SAFETY PRECAUTIONS - GENERAL INFORMATION

1. Never operate the Pallet Fork without first reading and understanding the **entire** operator's manual.
2. **Do not paint over**, remove or deface any safety signs or warning decals on your equipment.
3. **Follow all safety decals**. Keep them clean and replace them if they become worn, damaged or illegible.
4. Know your equipment inside and out. Know how to operate all controls and know emergency shut down procedures.
5. **Keep all stepping surfaces, pedals, and controls free from dirt, grease and oil**. Keep equipment clean to help avoid injury from slipping or falling when getting on or off equipment.
6. Operate the attachment only in daylight or sufficient artificial light.
7. Always carry loads close to the ground. Do not step off platform with load raised.
8. **Turn off engine before performing maintenance**. All maintenance can be performed with the machine arms lowered. If lift arms must be left raised for any reason, use a positive lift arm lock to secure the arms in place. Serious damage or personal injury could result from lift arms accidentally lowering.
9. **To avoid overturning the machine. Reduce speed when driving over rough terrain**, on a slope, or turning.
10. **Check your work area and know where all utility lines are**. Avoid hitting underground or overhead electrical wires, cables, pipes, fence posts, gas lines, etc.
11. **Never operate equipment while under the influence of** alcohol, prescription drugs or any other form of illegal recreational drugs which could inhibit physical and/or mental capacity.
12. Do not exceed recommended safe operating load of machine, as machine may become unstable resulting in loss of control.
13. **Slow down before turning**. Sharp turns on any terrain may cause loss of control.
14. **Always lower the loader arms to the ground**, shut off the engine and remove the key before getting off the unit.
15. Operators, helpers, and other personnel working near the equipment must wear steel-toe safety shoes, safety glasses, and hard hats as a minimum. Hearing protection, respirators, and personnel protective clothing will be specified in the site-specific Health and Safety Plan.
16. Do not smoke when refuelling. Allow room in the gas tank for expansion. Wipe up any spilt fuel. Secure cap tightly when done.
17. Be alert to others in the work area. Be sure others know when and where you will be working. Make sure no one is behind equipment or within 15 metres of it operating.
18. Loose fitting clothing, long hair, jewellery and equipment which might become entangled in moving equipment are prohibited while working near the Pallet Fork.
19. The equipment must be shut down and properly locked-out and tagged before repairs or maintenance is performed. Only properly trained and qualified individuals are permitted to perform repairs and maintenance.
20. Site workers shall not be allowed on the attachment while it is in operation.
21. Machinery must be shut down and the key removed before being left unattended.
22. Controls must be engaged slowly until hydraulic fluids and the unit are up to operating temperature. This is critical during cold weather impact or shock loading of the Pallet Fork is prohibited.
23. The Pallet Fork shall be used only for its designed intent and shall not be loaded beyond its rated capacity. Overloading or exceeding the manufacturers specifications will void all warranty.

24. Sharp braking or hoisting is prohibited.
25. Riding in or on the attachment is prohibited.
26. Only authorised, properly trained workers will be permitted to operate the Pallet Fork. All unnecessary personnel will stand clear while it is in operation.
27. The operator shall verbally alert site workers and visually ensure all site workers are clear from dangerous parts of equipment before starting or engaging equipment.
28. Operations must be stopped in the event of local thunderstorm, or lightning activity. During operation, weather conditions shall be monitored: operations shall cease during electrical storms or when electrical storms are imminent.

WHEN MOUNTING THIS PRODUCT TO YOUR LOADER

- Refer to the operator's manuals of your loader, and your quick-attach for special or detailed mounting instructions.
- This product should fit onto the quick-attach Frame.
- If this product does not fit properly, contact your Digga Dealer before operating.
- Never place any part of your body into the mounting plate or 3-point hitch or loader holes. A slight movement of the power unit in this product could cause serious injury.



ENSURE LOCKING PINS ON YOUR QUICK ATTACH ARE FULLY ENGAGED

BEFORE EACH USE, THOROUGHLY INSPECT THIS PRODUCT AND

- Make certain that all safety signs are in place and legible. Refer to the safety sign page in this manual for the placement of safety signs for this product.
- Replace all damaged or excessively worn parts and hardware only with genuine Digga parts or with properly rated fasteners or fittings.
- Make certain that all locking pins, latches, and connection devices are properly installed and secured.
- Make certain that all protective guards, canopies, doors, etc., are in place and secure.

WHEN ADJUSTING, SERVICING OR REPAIRING THIS PRODUCT

- Make no modifications to your pallet fork.
- When making repairs, use only genuine Digga parts or for fasteners, use only correctly rated parts.
- All maintenance should be performed with the machine arms lowered. If lift arms must be raised for any reason, use a positive lift arm lock to secure the arms in place. Serious damage or personal injury could result from lift arms accidentally lowering.
- Replacement parts, for parts with safety signs attached, must also have safety signs attached.

9 SAFETY - WORKING WITH THE ATTACHMENT

WHEN OPERATING THIS PRODUCT IN ACCORDANCE WITH DESIGN INTENTIONS

- Know your working area! Look up before raising pallet forks. Avoid hitting overhead wires, and other hazards.
- When the Pallet Fork is to be used on a seated Loader or Tractor, ensure that the machine is equipped with a cab or ROPS (Roll Over Protection Structure) and operator restraints (seat belts or equivalent devices).
- Do not use the Pallet Fork to dislodge overhead objects. Objects could fall and cause injury.
- Do not attach any other attachment or device to the Pallet Fork.
- Know your loader's safe operating weight limit, and the weight of loaded attachment. Refer to page 12
- Use caution when working close to fences and ditches, or on uneven ground.

10 TECHNICAL SPECIFICATIONS

	PF-001130-1500	PF-0011300-1800
Length	1314mm (51.7")	1464mm (57.6")
Height	964mm (38")	964mm (38")
Width	1170mm (46")	1170mm (46")
Weight	138Kg (304 lbs)	157Kg (346 lbs)
SAFE WORKING LOAD - SEE ILLUSTRATION ON PAGE 12		

For additional safety information please see Risk Management booklet. To obtain a copy contact Digga Head Office on 07 3807 3330

WARRANTY

All new Digga products are warranted to be free from defects in materials or workmanship, for a period of twelve (12) months from date of original purchase, which may cause failure under normal usage and service when used for the purpose intended. In the event of failure within twelve (12) months from initial retail sale, lease or rental date (excluding cable, ground engaging parts such as sprockets, digging chain, bearings, teeth, tamping and demolition heads, blade cutting edges, pilot bits, auger teeth, auger heads & broom bristles), if after examination, Digga determines failure was due to defective material and/or workmanship, parts only will be repaired or replaced. Digga may request defective product or products be returned prepaid to them for inspection at their place of business at 4 Octal Street Yatala, Queensland, or to a location specified by Digga. The warranty will be considered void if the product or any part of the product is modified or repaired in any way not expressly authorized by Digga, or if closed components are disassembled prior to return. Closed components include, but are not limited to: gearboxes, hydraulic pumps, motors, cylinders and actuators. Any goods returned to Digga by the customer under warranty or repair must have all freight charges prepaid for on the customers account. Any claims under this warranty must be made within fifteen (15) days after the Buyer learns of the facts upon which such claim is based. All claims not made in writing and received by Digga outside the time period specified above shall be deemed waived.

THIS WARRANTY IS IN LIEU OF ALL OTHER WARRANTIES EXPRESSED OR IMPLIED AND THERE ARE NO WARRANTIES OF MERCHANTABILITY OR OF FITNESS FOR A PARTICULAR PURPOSE. IN NO EVENT SHALL DIGGA BE LIABLE FOR CONSEQUENTIAL OR SPECIAL DAMAGE. DIGGA'S LIABILITY FOR ANY AND ALL LOSSES AND DAMAGES TO BUYER, RESULTING FROM ANY CAUSE WHATSOEVER, INCLUDING DIGGA'S NEGLIGENCE, IRRESPECTIVE OF WHETHER SUCH DEFECTS ARE DISCOVERABLE OR LATENT, SHALL IN NO EVENT EXCEED THE PURCHASE PRICE OF THE PARTICULAR PRODUCTS WITH RESPECT TO WHICH LOSSES OR DAMAGES ARE CLAIMED, OR, AT THE ELECTION OF DIGGA, THE REPAIR OR REPLACEMENT OF DEFECTIVE OR DAMAGED PRODUCTS.



Australian Designed and Manufactured

Available through

**EARTHMOVING
WAREHOUSE**

earthmovingwarehouse.com.au

0459927346 (0459 WAREHOUSE)
Shed C1/C2 194 Zillmere Road,
Boondall Brisbane 4034
QLD