

**HAMILTON** 

# Microlab<sup>®</sup> 700 Series

Smart Liquid Handling



**Microlab® 700 Series**  
Smart Liquid Handling



# Table of contents

Introducing the Microlab 700.....	4
Dual Syringe Diluters .....	6
Dispensers .....	10
Standalone Syringe Pumps .....	12
Microlab 700 Hardware .....	14
Microlab Software.....	16
Controller.....	18
Universal Valves.....	20
Bubble Free Prime Syringes .....	21
Accessories.....	22
Replacement Parts .....	24
Specifications.....	26



# Introducing the Microlab<sup>®</sup> 700

Microlab<sup>®</sup> 700 is a highly precise syringe pump with a new generation touchscreen controller that brings a superior technological solution, interface designed to quickly and easily dilute and dispense fluids. This positive displacement system provides better than 99% accuracy, independent of a liquid's viscosity, vapor pressure, and temperature. The inert fluid path minimizes sample carryover and is compatible with harsh chemicals.

## All Laboratories can use the Microlab 700

Every laboratory has tasks too small to automate and too large to reliably accomplish by hand. The Microlab 700 is a semi-automated liquid handler designed specifically for these in-between applications that increase throughput and consistency while reducing cost and wasted buffer. Common industries using the product are:

- Pharma
- Biotechnology
- IVD and Forensics
- Food Industry
- Dairy Industry
- Environmental Analysis
- Mining Industry
- Textile Industry



## Advantages of the new Microlab 700 Controller

- ✓ Innovative possibilities for communication options
- ✓ A full range of peripherals and documentation solutions
- ✓ Easier troubleshooting and failure statistics
- ✓ Smart data storage
- ✓ Designed for easy integration into LIMS systems



# Dual Syringe Diluters

## Concorde Hand Probe

The Dual Syringe Diluter configuration uses two syringes to create up to a 1:50,000 dilution in a single step, drastically reducing preparation time and wasted buffer. The diluent washes the tubing between each sample, minimizing carryover for even the most sensitive techniques including:

- Atomic absorption (AA)
- Inductively coupled plasma spectroscopy (ICP)
- High performance liquid chromatography (HPLC)
- Gas chromatography (GC)
- Liquid scintillation



How Does It Work?

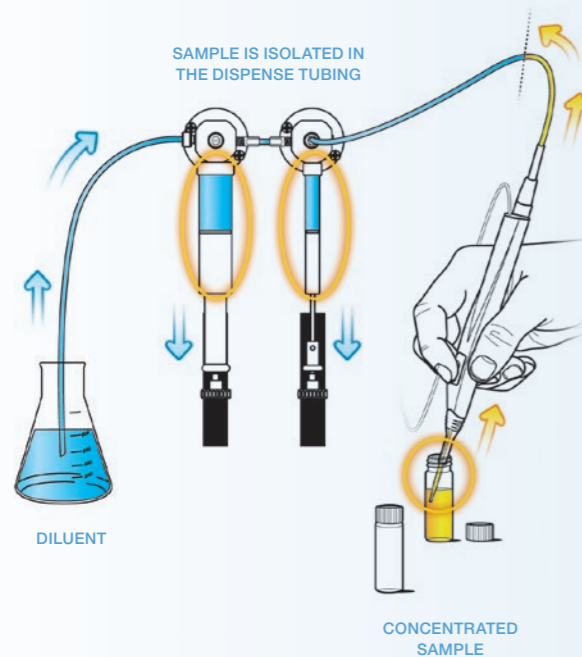

- Step 1**  
Program sample and diluent volume.
- Step 2**  
Trigger the hand probe to fill left syringe with diluent and aspirate sample into the hand probe with the right syringe.
- Step 3**  
Trigger the hand probe to dispense the sample and then the diluent into the vial to complete the dilution and wash the tube for the next sample.

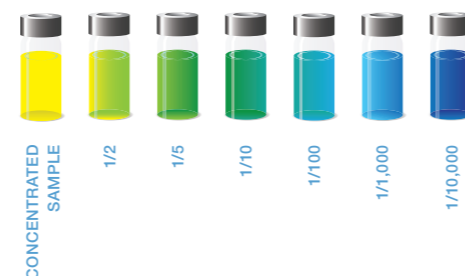

### Dilution Wizard

Accurately dilute concentrated samples with diluent over a wide range of dilution ratios.

#### Dual Syringe Dilution

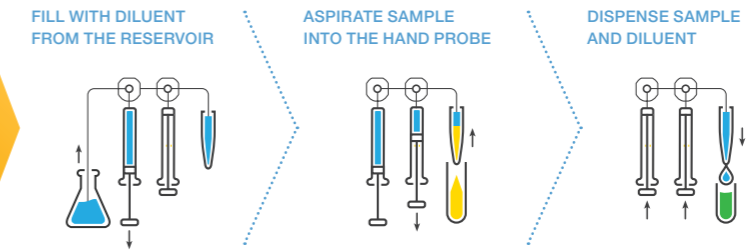

#### Serial Dilution (Programmed)

Repeat the steps for single or dual dilution with varying dilution ratios and the same final volume.

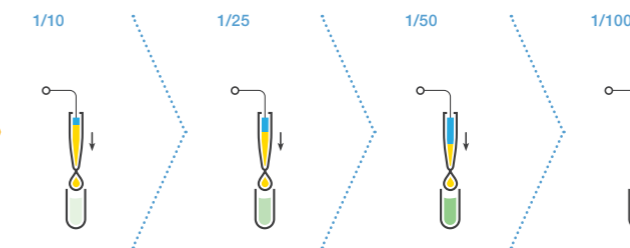

#### Serial Dilution (Tube to Tube)

Repeat the steps for single or dual dilution and use the resulting dilution as the sample for the next dilution.

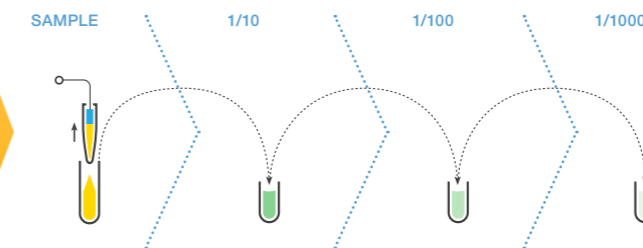

#### Multi Sample Dilution (or Internal Standard Addition)

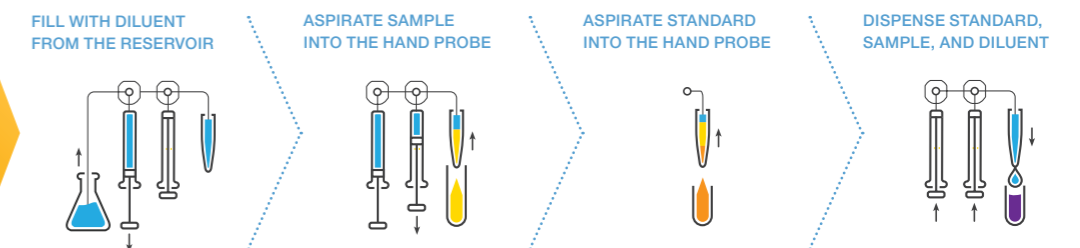

#### Icon Key

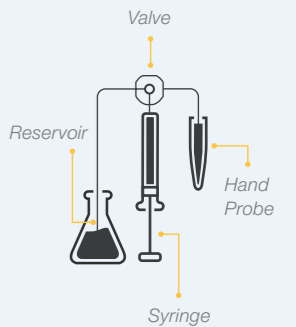

#### Color Guide

- Diluent 1 / System Fluid
- Sample
- Diluted Sample
- Standard
- Diluted Sample + Standard

### Diluter Ordering Information

Part number	Product name	Description
10103468	ML715-DIL	Dual syringe diluter with Advanced controller
10103471	ML725-DIL	Dual syringe diluter with Premium controller

The -DIL model ships with the Concorde hand probe, universal valves, fill/dispense tubing, accessory holder, country-specific power cord, and the choice of two syringes. If syringes are not selected at the time of the order, 2.5 mL and 250 µL syringes are included.







# Disposable Tip Hand Probe (DTHP)

For sensitive applications, the sample is aspirated into a disposable plastic tip which is thrown away between each sample, eliminating any chance for carryover. Applications that benefit from the DTHP include:

- Forensics – for some applications regulatory considerations make disposable tips the preferred option
- Sterile samples – sterile disposable tips can be used to avoid transferring contamination between sample vessels
- DNA amplification – for applications where a single amplified strand of DNA is enough to impact results



## Dilution Options

### Single Sample Dilution

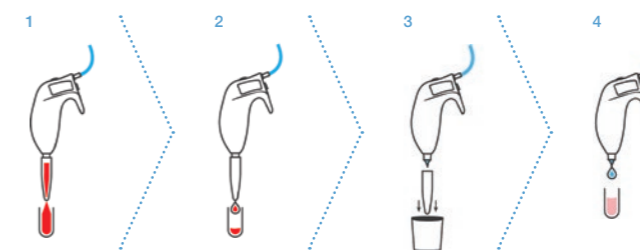

- The trigger is pressed and the sample is aspirated into the tip using the right syringe while diluent is drawn into the left syringe
- The trigger is pressed again and the sample is dispensed from the tip
- The tip is ejected
- Another trigger dispenses the diluent to complete the dilution

### Multi Sample Dilution

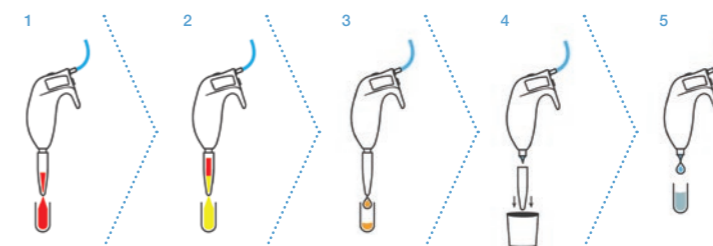

- Aspirate Sample 1 into ClickSure Tip
- Aspirate Sample 2. Repeat with additional solutions
- Dispense Samples
- Discard ClickSure Tip
- Dispense Diluent

### Icon Key

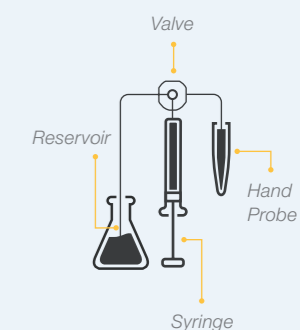

### Color Guide

- Sample 1
- Sample 2
- Dispensed Samples
- Diluted Sample
- Diluted Samples

## Disposable Tip Hand Probe Ordering Information

Part number	Product name	Description
10103470	ML725-DTHP	Microlab 700 Diluter with Disposable tip Hand probe

## ClickSure Tips for DTHP Ordering Information



Part Number	Description	Part Number	Description
235537	50 µL, non-sterile ClickSure Tips, 960 tips, racked	235539	1 mL, non-sterile ClickSure Tips, 960 tips, racked
235543	50 µL, non-sterile ClickSure Tips, 960 tips, bulk	235545	1 mL, non-sterile ClickSure Tips, 960 tips, bulk
235536	50 µL, sterile ClickSure Tips, 960 tips, racked	235538	1 mL, sterile ClickSure Tips, 960 tips, racked

The -DTHP model ships with the Disposable Tip Hand Probe, universal valves, fill tubing, Cable Management System, country-specific power cord, and the choice of two syringes. If syringes are not selected at the time of the order, 2.5 mL and 250 µL syringes are included.



# Dispensers

The Microlab 700 is able to dispense volumes from 100 nL to 50 mL and uses positive displacement syringes to accurately dispense volatile, viscous, and dense liquids independent of atmospheric influences. The inert fluid path is compatible with harsh chemicals, making the Microlab 700 the most reliable and robust dispensing system available.



## Single Syringe Dispenser

The syringe fills from a reservoir and dispenses from the hand probe.

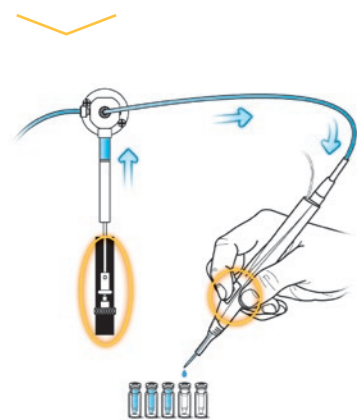

## Dual Syringe Dispenser

Each syringe fills from a separate reservoir and dispenses separately from the hand probe.

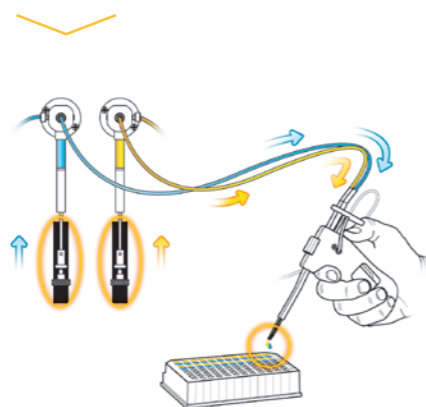

## Continuous Dispenser

One syringe fills while the other syringe is dispensing from the same reservoir.

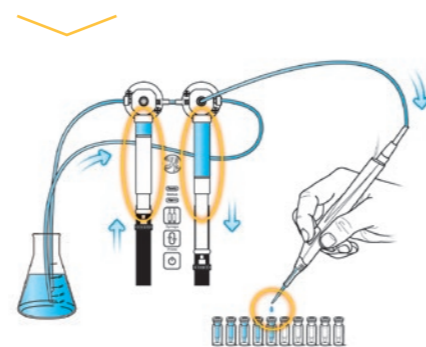

## Aliquot Dispense Wizard

Repetitively dispense aliquots of the same volume at the press of a button.

### Single Syringe Aliquot or Serial Dispense

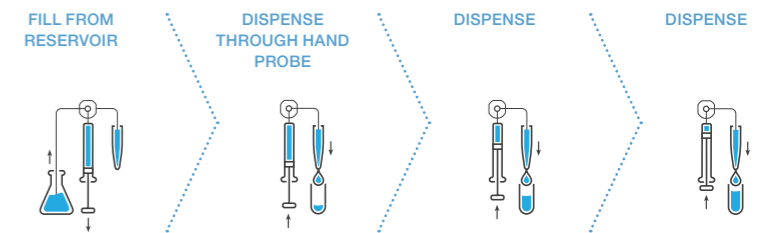

## Serial Dispense Wizard

Repetitively dispense aliquots of differing volumes at the press of a button.

### Dual Syringe Aliquot or Serial Dispense

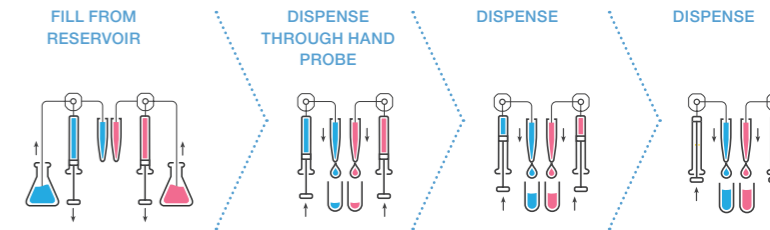

## Titration Wizard

Slowly add liquid to another liquid until an end-point is reached. An example of this application is adding acid or base to a pH buffer.

### Titration

A large initial volume is dispensed to get close to the endpoint. Then a smaller step volume is dispensed until the endpoint is reached.

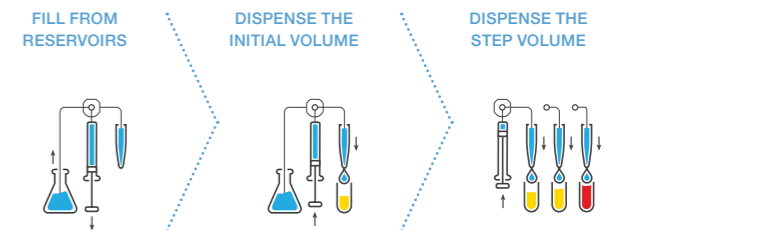

## Pipette Wizard

Simulate a manual pipette used to transfer liquid from one vessel to the next.

### Pipette

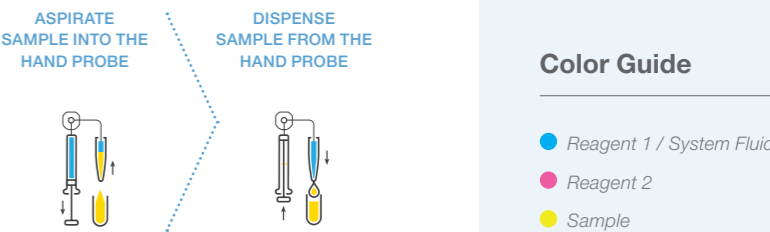

### Color Guide

- Reagent 1 / System Fluid
- Reagent 2
- Sample
- Titration Endpoint

## Dispenser Ordering Information

Part number	Product name	Description
10103458	ML710-DIS	Single Syringe Dispenser with Advanced Controller
10103460	ML720-DIS	Single Syringe Dispenser with Premium Controller
10103461	ML715-DIS	Dual Syringe Dispenser with Advanced Controller
10103464	ML725-DIS	Dual Syringe Dispenser with Premium Controller
10103465	ML715-CNT	Dual Syringe Continuous Dispenser with Advanced Controller
10103467	ML725-CNT	Dual Syringe Continuous Dispenser with Premium Controller

All dispensers ship complete with a Concorde hand probe (the dual -DIS uses the Dual Push Button hand probe), universal valve(s), fill/dispense tubing assembly, accessory holder, country-specific power cord, and the choice of syringes. If no syringe(s) are selected at the time of the order the -DIS will ship with 1 mL syringe(s) and the -CNT will ship with 10 mL syringes.





# Standalone Syringe Pumps

## Simple to Integrate

Take full command of your diluting and dispensing applications with the Microlab 700 standalone syringe pump. The standalone syringe pump allows you to custom program methods and deploy commands to any instrument on your network from anywhere in the world, giving you unparalleled control of your process.



## Choose Ethernet or RS-232 Communication

### Choose Ethernet Communication if

- The application requires control over all details of the pump like the front LED lights, acceleration speeds, custom initialization routines, etc.
- Remote control or monitoring of the pump is important. This includes dispensing in restricted environments like clean rooms, rooms with high radioactivity, or chemical contamination, etc.
- Development is being done in a Microsoft .NET 2.0 programming environment. The API simplifies programming with on screen help in an industry standard format.

### Choose RS-232 Communication if

- The control device is a Programmable Logic Controller.
- The control device is not a PC running Windows® or the programming language is not compatible with Microsoft® .NET 2.0 framework.
- The application has already been implemented using an older RS-232 device like Microlab 500.
- The application requires the use of another Hamilton RS-232 device like Modular Valve Positioner.

### Standalone Pump Ordering Information

Part Number	Description
ML630	Single Syringe Pump
ML635	Dual Syringe Pump

*All standalone pumps ship complete with a universal valve(s), country-specific power cord, Custom Programmer kit, and choice of syringes. If no syringe(s) is/are selected at the time of the order 1 mL syringe(s) will be included automatically.*



# Microlab 700 Hardware

## Controller Features

The Microlab 700 controller features a large, easy-to-use touchscreen with a processor more than 20 times faster than the original controller. A dedicated host USB port enables connection to a keyboard, mouse, printer, scanner, RFID, label printer, and barcode reader.

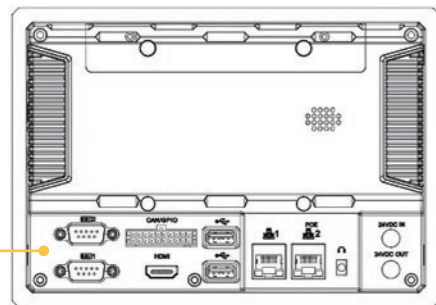

### Microlab 700 Connectors

Connector	Interface	Function
IOIO #1	RS232C COM1	Analytical or precision balance
IOIO #2	RS232C COM2	Label printer, Log printer
Micro SD card slot	Micro SD	Slot for SD cards up to 64 GB
USB-A #1	USB 2.0 host	Slot for USB flash drive up to 64 GB
USB-A #2	USB 2.0 host	RFID-scanner, QR code scanner
RJ-45 #1	LAN-1 100M	Microlab 700 base unit
RJ-45 #2	LAN-2 100M	LAN for intranet and internet
Power Jack IN	24VDC IN	Power input from DC power cable
Power Jack OUT	24VDC OUT, 3A max	Power output for Microlab 700 base unit
SD Slot	Micro SD	Slot for Micro-SD card on the right side
Wi-Fi	802.11 a/b/g/n 2.4 GHz	Wireless LAN for intranet and internet
Bluetooth 4.0	2402MHz-2480MHz	Used for accessories in future



MICROLAB LABEL PRINTER



MICROLAB DIGITAL SCANNER



MICROLAB RFID READER

### Controller Accessories

Part number	Product name
10106736	Microlab RFID Reader
10106738	Microlab Digital Scanner
10106739	Microlab Label Printer*
10106806	Labels for Microlab Label Printer

\* Power supply cord will be selected from page 24

## Syringe Pump Features

The Microlab 700 is available as a single or dual syringe system. The high torque, precision stepper motors provide unsurpassed positional accuracy across the full range of Hamilton syringes from 10 µL to 50 mL. The instrument communicates with the controller or a corporate network via an Ethernet port. Serial communication via RS-232 is also possible for programming in a non Windows® environment.



- 1 High torque valve motors
- 2 Precision syringe drives with 48,000 step resolution over 60 mm
- 3 Lighted power and prime buttons
- 4 Independent left and right trigger ports

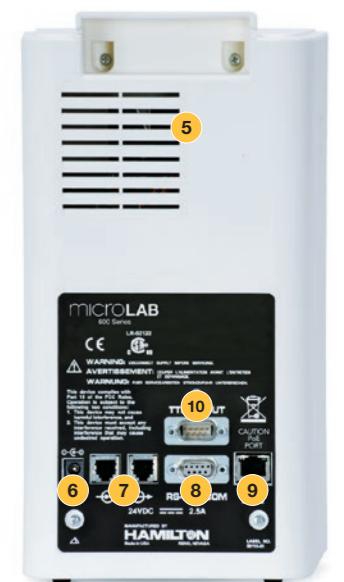

- 5 Fanless heat vent
- 6 24 volt power input
- 7 CAN daisy chain input/output
- 8 RS-232 console port
- 9 Power over Ethernet (PoE)
- 10 TTL input/output



# Microlab Software

## NEW UTILITIES



### New Utility Menus

- Easy to access and human readable error log
- Audit Trail viewer
- Update software via internet
- Update software via USB flash drive / SD card
- Log Viewer: Logs can be opened with PDF viewer, directly on the controller screen
- Possibility to create a full encrypted system backup and device specific (protected to access only for a specific device)
- Restore function

## UPDATED WIZARD



### Dry Weight Dilution 2.0

- Improved usability
- Save to favorites
- Support of many balance models (Mettler, Sartorius, Kern, Ohaus)

## NEW CLEANING MENU



### Cleaning features

- Cleaning reminder (time period-based)
- Cleaning reminder (cycle count based)
- Auto reset of reminder after cleaning

## MAINTENANCE

### Maintenance features

- Error statistics
- Maintenance reminder (date-based)
- Maintenance warning (time period-based)

## NEW USER SUPPORT



### New Help Menu

- Send emails to customer support directly from device
- Read user manual directly from device
- Screen sharing (Remote control)
- Tutorial videos
- Easier understanding of the Microlab platform functionalities through the new help menu

## NEW CONFIGURATIONS



### New LyncStore 700 Menu Premium Version only

- Add LyncStore Account
- Sync Log files
- Sync Audit Trail
- Sync Custom Methods
- Sync Favorite Methods (created by means of the existing Wizards)
- Allow Remote Access



### New Communication Menu

- Manage WLAN
- Manage LAN
- Manage external devices & accessories



### New GLP Printer Menu

- Configure GMP/GLP complaint print content (Protocol Printer)



### New Security Settings

- Multiple Administrator accounts
- Enable Audit Trail Dialogs (Parameter change must be justified)
- Enable PDF signatures
- Automatic sign out after X minutes
- Sign-in with RFID card

# Advanced Controller Software

The controller is ideal for completing simple diluting and dispensing tasks. Quickly set the desired volume in the Quick Start Run Screen and begin.

## Simple Diluting

Diluent is drawn by the left syringe and sample is drawn into the tubing by the right syringe. Both syringes dispense to complete the dilution.

## Simple Dispensing

Solvent is drawn into the syringe and dispensed out through the hand probe.

**Run Screen**

Quick Start

Dispense from left and right syringe

IN → OUT

Volume in  $\mu\text{L}$ : 3000

Volume in  $\mu\text{L}$ : 1000

3,000.0  $\mu\text{L}$  Refill OFF 1,000.0  $\mu\text{L}$

Main Menu Help Run

Press this button to adjust the dispense volume at any time

Graphical status of the current valve and syringe position

Toggle the Auto Refill button ON and OFF

**Configuration Screen**

Microlab 700

Quick Start Wizards Custom Methods

Configuration Utilities Help

Custom Method Scan Log Scan Favorites

Dedicated Wizards for aliquot dispensing, serial dispensing, dilution, pipetting, and titration

Create custom applications not covered by a Wizard

Help menu (see on the left)

Press to proceed to the Run screen

Configure valves, syringes, system settings, view firmware revision, etc.

Review system logs and run system updates

# Controller



## Compliance and Logging

The software provides a variety of security protections, simplifies adherence to FDA GXP regulations, ability to administer user accounts and passwords, create log files that conform to 21 CFR Part 11 and manage log files on a PC using the LyncStore application.



## Language Support

The Microlab 700 features language support for English, Spanish, German, French, Italian, and Chinese.



## Archiving and Sharing Methods

Favorites and Custom Methods are stored on the Internal Storage or external: USB, microSD or remotely by LyncStore connectivity.

## Wizards

Wizards are designed to simplify the programming of common everyday methods. The controller ships with the most popular Wizards installed but it is simple to add or delete Wizards from the menu. Visit [www.hamiltoncompany.com/microlabwizards](http://www.hamiltoncompany.com/microlabwizards) to see a complete list of available Wizards.

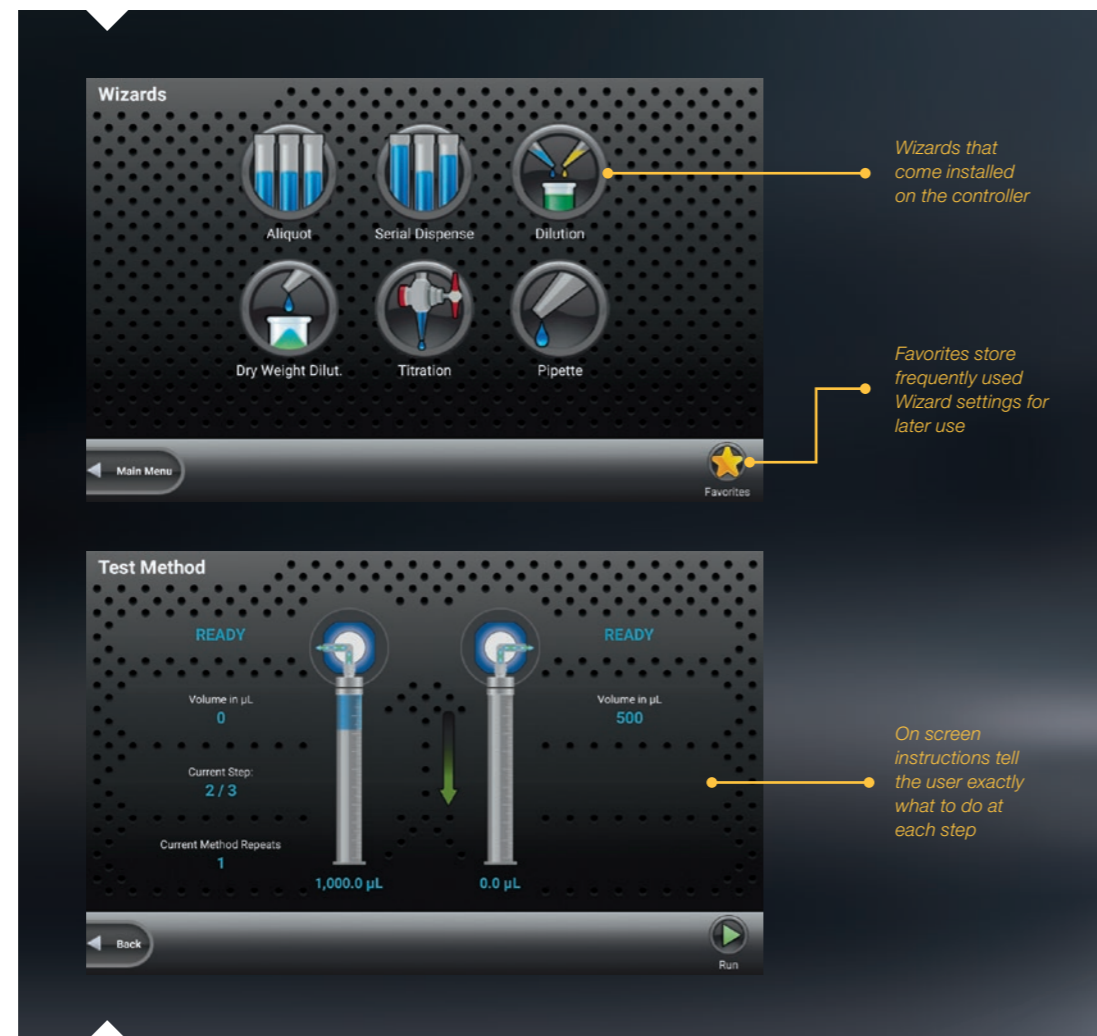

## Custom Methods

Custom methods can be created to accomplish unique liquid handling tasks. Incorporate loops, delays, external triggering, and execution counters with valve and syringe movements to create complex methods.



# Premium Configuration

## LyncStore 700 features

- Best-Practice API documentation with swagger
- Compliant with 21 CFR Part 11
- API comes with a web interface
- Realtime access to Microlab 700
- Automatic data backup
- Remote control

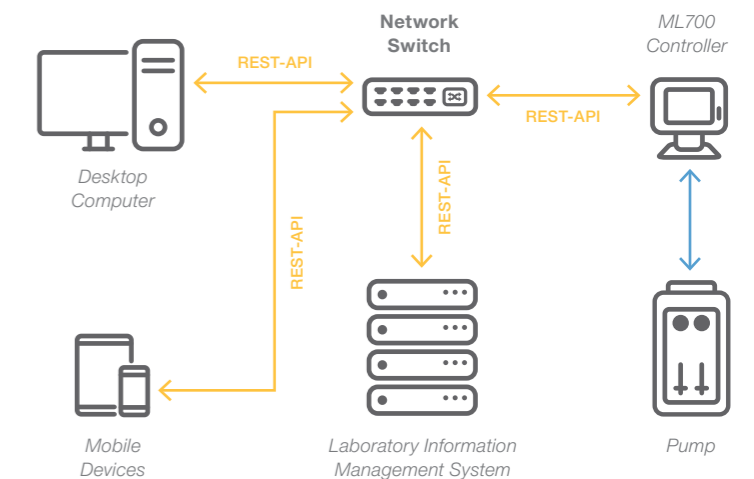

Premium Configuration Screen





# Universal Valves

Innovative fluid logic allows the same universal valve to be used in all Microlab 700 diluting and dispensing applications. Interchange the valve plugs and tubing to achieve the following configurations in a matter of minutes.

Valve Plumbing Based on Instrument Configuration:

## Dual Syringe Diluter

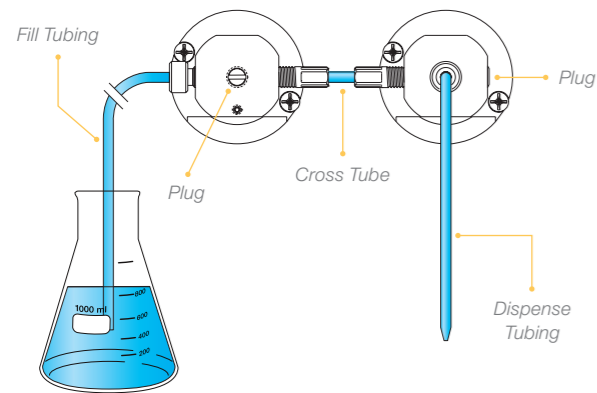

## Single Syringe Dispenser

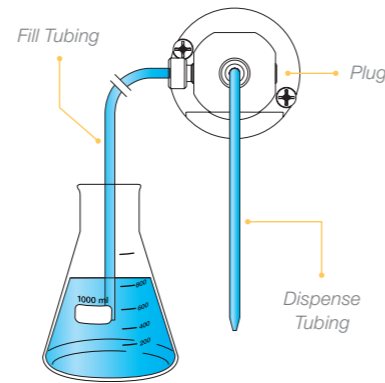

## Dual Syringe Dispenser

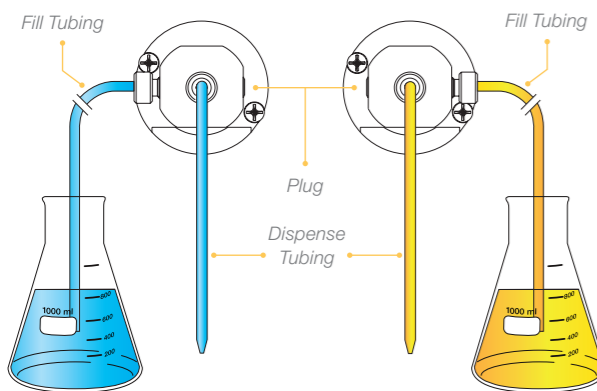

## Continuous Dispenser

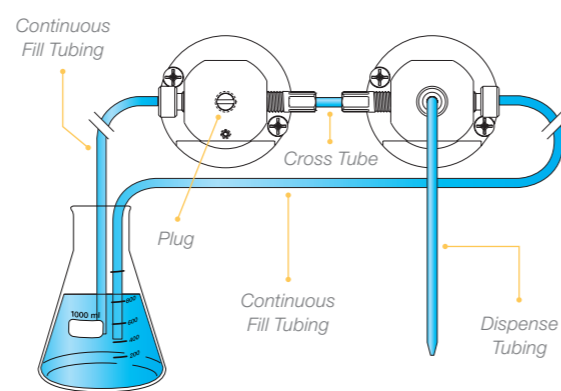

# Bubble Free Prime Syringes

For any syringe pump, the key to achieving the most accurate dispenses is eliminating all air from the fluid path. Traditional syringes trap approximately 50  $\mu\text{L}$  of air between the tip of the syringe and the valve. For small syringes, this trapped air is the last to leave the syringe and the first to be drawn back in, making them difficult if not impossible to prime.

The Bubble Free Prime syringe has a conical plunger tip that extends through the threaded termination and into the valve. This unique design expels the air from the syringe and valve decreasing the number of priming cycles required.

## Bubble Free Prime Syringe

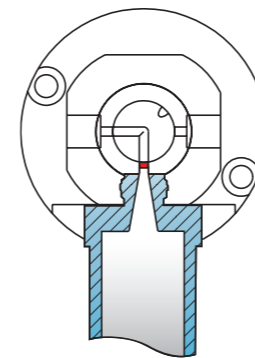

Bubble Free Prime syringes eliminate air from the fluid path

## Standard Syringe

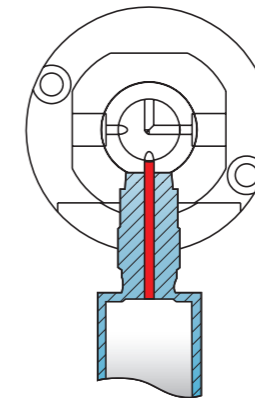

Traditional Luer Lock syringes trap approximately 50  $\mu\text{L}$  of air, making small syringes nearly impossible to prime

### Color Guide

■ Trapped Air   
 ■ Syringe   
 ■ Plunger

Patented conical tip extends through the threaded termination and into the valve



# Accessories

## Protect Your Investment with AirShield

The AirShield is a separate accessory that can be purchased for any Microlab 600 instrument. It creates a positive pressure blanket of fresh air inside the pump that pushes air out over critical components on the outside of the pump, protecting them from the environment.



### Localized Harsh Environment

In many labs the air is relatively clean but samples and reagents placed near the instrument result in a localized environment that can be harmful. For these labs, it is sufficient to source clean air from the back of the instrument away from the microenvironment.



### Optional Snorkel for Fresh Air Supply

For labs with a more demanding atmosphere it is possible to source clean air via a snorkel that connects directly to the AirShield. Fresh air is then brought from outside the harmful environment to create a shield of clean air around all critical instrument components.

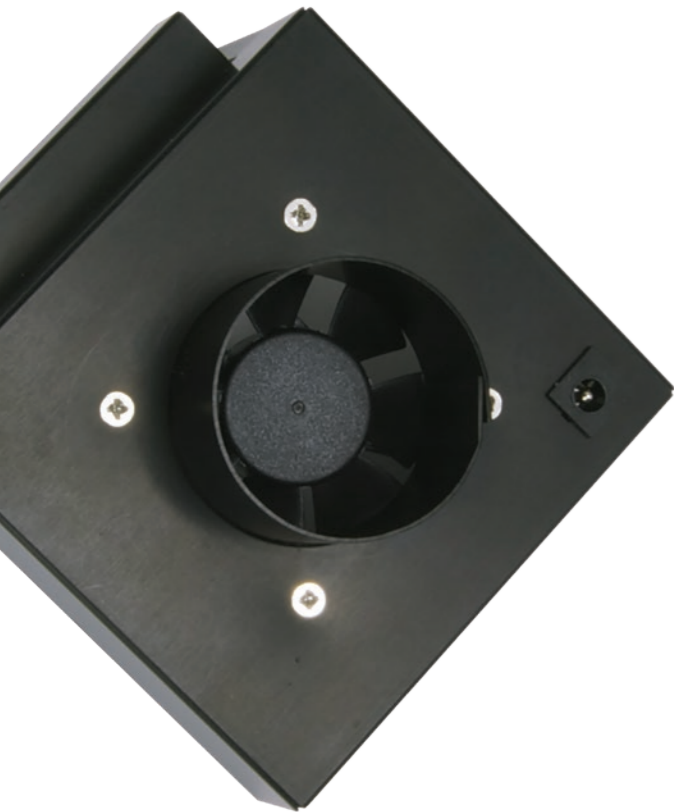

**LUER LOCK CONVERSION KIT**  
P/N 58381-01



**DUAL PUSH BUTTON HAND PROBE**  
Standard with the Dual Syringe Dispenser



**DISPOSABLE TIP HAND PROBE**  
0.5–1000  $\mu$ L

**CONCORDE CT HAND PROBE**  
Standard with the Single Syringe Dispenser,  
Dual Syringe Diluter, and Continuous Dispenser



**LARGE VOLUME DISPOSABLE TIP HAND PROBE**  
1–5 mL

## Hand Probes, Foot Switch, and Printer Kit



**FOOT SWITCH**

### Accessories

Part Number	Description
61401-01	Concorde CT Hand Probe
62541-01	Dual Push Button Hand Probe
63960-02	Disposable Tip Hand Probe (0.5–1000 $\mu$ L)*
62575-01	Large Volume Disposable Tip Hand Probe (1–5 mL)
75702	5 mL Disposable Tips (250/pk)
62576-01	Foot Switch
68562-01	AirShield
93009-01	AirShield Tubing (includes tubing clamp)

\* Tips for this probe can be found on page 9



# Replacement Parts

## Syringes and Power Supplies

### Standard Syringes

Part Number	Syringe Size	Optimal Range
59000-05	10 µL	1–10 µL
59000-10	25 µL	2.5–25 µL
59000-15	50 µL	5–50 µL
59000-20	100 µL	10–100 µL
59000-25	250 µL	25–250 µL
59000-30	500 µL	50–500 µL
59000-35	1.0 mL	100 µL–1.0 mL
59000-40	2.5 mL	250 µL–2.5 mL
59000-45	5.0 mL	500 µL–5.0 mL
59000-50	10.0 mL	1–10.0 mL
59000-55	25.0 mL	2.5–25.0 mL
59000-60	50.0 mL	5–50.0 mL

### SaltLine Syringes

Part Number	Syringe Size	Optimal Range
208335	1 mL	100 µL–1.0 mL
208336	5 mL	500 µL–5.0 mL
208337	10 mL	1–10.0 mL

### Power Supply & Power Cords

Part Number	Description	Diagram of Plug
61092-01	Power Supply Universal (110–220 VAC)	
355008	Switzerland	
3892-01	Continental Europe, Russia, Schuko	
3892-02	Australia, New Zealand, Argentina, China	
3892-03	UK, Ireland, Malaysia, Middle East	
3892-05	USA, Canada, Mexico, Central America, Brazil, Japan	

### Selecting a Syringe

Select the smallest syringe with a maximum volume that is greater than the largest volume to be dispensed. Ideally the smallest volume to be dispensed should fall within the optimal ranges listed to the left. The MicroLab 700 can dispense volumes below the optimal range but there will be some impact on accuracy and precision. The SaltLine Syringes should be used when working with solutions that have a high salt concentration. Contact a Hamilton sales representative for additional assistance.

POWER CORD



POWER SUPPLY

## Miscellaneous Accessories

### Universal Valves & Accessories

Part Number	Valve Assembly Description
60676-01	Left Valve Assembly
60675-01	Right Valve Assembly
61498-01	Valve Cross Tube Assembly
61729-01	Valve Plug (1/pk)

### PTFE Tubing Assemblies

Part Number	Gauge	Type	Length	Internal Volume
61615-01	18	Fill Tubing	48" (1219 mm)	0.96 mL
240134	18	Dispense Tubing	54" (1372 mm)	1.08 mL
1174-02	18	Fill Tubing	Custom Length	0.79 µL/mm
1173-02	18	Dispense Tubing	Custom Length	0.79 µL/mm
61614-01	12	Fill Tubing	48" (1219 mm)	3.83 mL
240133	12	Dispense Tubing	54" (1372 mm)	4.31 mL
1172-02	12	Fill Tubing	Custom Length	3.14 µL/mm
1171-02	12	Dispense Tubing	Custom Length	3.14 µL/mm
61491-02	18	Continuous Fill Tubing		0.79 µL/mm
61491-01	12	Continuous Fill Tubing		3.14 µL/mm

### Activation Key

Part Number	Upgrade Kit
10101502	ML700 Premium Activation Key

### Other Accessories

Part Number	Description
88990	Tubing Clips (5/pk)
61710-01	Accessory Holder & Tubing Wire Stand
65160-01	Cable Management System



LEFT VALVE



RIGHT VALVE



VALVE PLUGS



CROSS TUBE



FILL & DISPENSE TUBING  
Dispense tubing has tapered end



WIRE STAND



TUBING CLIPS



ACCESSORY HOLDER



# Specifications

## Controller Specifications

<b>System Configuration</b>	CPU NXP i.MX 6DualLite 800MHz
	ARM Cortex-A9 processor
<b>Media</b>	RAM: 1 GB DDR3, ROM: 8 GB
	GPU 3D Vivante GC880 35Mtri/s 266Mpxl/s Open GL ES 2.0
<b>Interface</b>	OS: Android 5.1.1 / Linux Debian 8.0
	Audio: MP3, MP4, WMA, WAV...
<b>Function (Optional)</b>	Video Decode 1080p30 + D1
	Video Encode 1080p30 H.264 BP / Dual 720p
<b>Touch Panel</b>	HDMI output, support up to 720p
	Micro SD (TF) card slot, support up to 64G
<b>Display</b>	SIM card slot (mini SIM)
	USB Device 2.0(OTG)x1, USB host 2.0x2
<b>Power supply</b>	Gpio inputx4, Gpio outputx6, CAN 2.0Bx2
	IOIO1 (COM1 COM4 COM5)
<b>Power Consumption</b>	IOIO2 (COM2 RS422 RS485)
	LAN1 100M
<b>Temperature</b>	LAD2 200M, PoE for optional
	Earphone jack
<b>Dimension</b>	DC power input
	3G / 4G
<b>Weight</b>	Wi-Fi 802.11a/b/g/n 2.4 GHz
	Bluetooth 4.0 2402MHz~2480MHz

## Single and Dual Syringe Pump Specifications

<b>Accuracy</b>	+/- 1%
<b>Precision</b>	+/- 0.2%
<b>Syringe drive mechanism</b>	1.8° stepper motor with variable volumetric flow rate
<b>Flow rate</b>	0.003–6000 µL/second (depending on the syringe that is selected)
<b>Syringe resolution</b>	0.002% of the nominal syringe volume
<b>Compatible syringes</b>	10, 25, 50, 100, 250, 500 µL, 1, 2.5, 5, 10, 25, and 50 mL BFP Syringes
<b>Volume range</b>	1.0 µL–50 mL
<b>Fluid path</b>	Borosilicate, PTFE, CTFE
<b>Communication type</b>	Ethernet, 10/100 BASE-T
<b>Communication protocol</b>	.NET 2.0 Application Programming Interface (API)
<b>Pump memory</b>	One method stored in non volatile memory
<b>Calibration</b>	Factory tested and traceable to N.I.S.T. standards
<b>Certifications</b>	CE, CSA
<b>Power requirements</b>	100–240 V 1.5 A max 50160 Hz
<b>Power rating</b>	24 VDC, 2.5 A
<b>Dimensions</b>	7 x 5.5 x 10.5 inch (177.8 x 139.7 x 266.7 mm)
<b>Weight</b>	13 lbs (5.9 kg)

# About Hamilton

## The Measure of Excellence®

Hamilton Company specializes in the development, manufacturing, and customization of precision measurement devices, automated liquid handling workstations, and sample management systems. Hamilton's processes are optimized for quality and flexibility. Whether it's a custom needle with a quick delivery timeframe, a special length pH sensor, or a comprehensive solution to fully automate your assay workflow, trust that Hamilton's products will always meet your needs.

## Our complete portfolio

### Laboratory Products

Hamilton Laboratory Products manufactures Microliter™ and Gastight® syringes that set the standard for analytical fluid measurement. Other products include custom needles, semi-automated diluters and dispensers, polymeric HPLC columns, pH electrodes, pipettes, and more.

### Robotics

Hamilton Robotics provides automated liquid handling workstations and laboratory automation technology for the scientific community. With a focus on innovative design, our products incorporate Hamilton's patented liquid handling technologies for fully automated solutions. In addition to liquid handling platforms, we also offer application-specific solutions, small devices, and consumables.

### Storage

Hamilton Storage offers ultra-low temperature automated sample management systems for storage of a variety of labware. Hamilton's line of biobanking and compound management systems, benchtop devices, and consumables are designed for sample integrity, flexibility, and reliability.

### Process Analytics

Hamilton Process Analytics includes innovative solutions for the online measurement of pH, dissolved oxygen, conductivity, ORP, viable cell density, and total cell density. Hamilton's proprietary Arc® intelligent sensor technology eliminates the need for transmitters and moves the functionality to your smartphone or tablet.

### OEM Solutions

Many of the world's top manufacturers utilize Hamilton products and expertise to get their innovations to market faster with lower development and manufacturing costs. As an OEM partner, we offer the ability to integrate our proven syringe pumps or pipetting channels, customize our proven liquid handling platforms, or design a complete system to automate your novel chemistry.

Hamilton Company has been a leading global manufacturer for more than 60 years, with headquarters in Reno, Nevada; Franklin, Massachusetts; Timișoara, Romania; and Bonaduz, Switzerland; and subsidiary offices throughout the world.







Your Hamilton Representative

©2020 Hamilton Company. All rights reserved.

Microsoft, .NET, Visual C#, and Visual Basic are registered trademarks of Microsoft Corporation in the United States and other countries.

LabVIEW is a trademark of National Instruments. Neither Hamilton Company, nor any software programs or other goods or services offered by Hamilton Company, are affiliated with, endorsed by, or sponsored by National Instruments.

All other trademarks are owned and/or registered by Hamilton Company in the U.S. and/or other countries.

Lit. No. 10108577/00 - 08/2020

**HAMILTON** 

Web: [www.hamiltoncompany.com](http://www.hamiltoncompany.com)

USA: 800-648-5950

Europe: +40-356-635-055

**Hamilton Americas & Pacific Rim**

Hamilton Company Inc.  
4970 Energy Way  
Reno, Nevada 89502 USA  
Tel: +1-775-858-3000  
Fax: +1-775-856-7259  
[sales@hamiltoncompany.com](mailto:sales@hamiltoncompany.com)

**Hamilton Europe, Asia & Africa**

Hamilton Central Europe S.R.L.  
str. Hamilton no. 2-4  
307210 Giarmata, Romania  
Tel: +40-356-635-055  
Fax: +40-356-635-060  
[contact.lab.ro@hamilton-ce.com](mailto:contact.lab.ro@hamilton-ce.com)

To find a representative in your area, please visit [hamiltoncompany.com/contacts](http://hamiltoncompany.com/contacts).