

Operating Instructions

Liquiline Mobile CML18

Multiparameter mobile device







Table of contents







1	About this document	4	10	Diagnostics and troubleshooting	42
1.1	Warnings	4	10.1	Diagnostics information via the local display	42
1.2	Symbols	4			
1.3	Symbols on the device	5			
2	Basic safety instructions	6	11	Maintenance	43
2.1	Requirements for the personnel	6	11.1	Maintenance tasks	43
2.2	Intended use	6	11.2	Measuring and test equipment	43
2.3	Workplace safety	6			
2.4	Operational safety	7	12	Repair	44
2.5	Product safety	7	12.1	Return	44
3	Product description	8	12.2	Disposal	44
3.1	Product design	8	13	Accessories	44
4	Incoming acceptance and product identification	10	13.1	M12 USB data + charging cable	45
4.1	Incoming acceptance	10	13.2	Protective cover	45
4.2	Product identification	10	14	Technical data	46
4.3	Scope of delivery	11	14.1	Input	46
5	Electrical connection	12	14.2	Output	46
5.1	Connecting the sensor	12	14.3	Power supply	47
5.2	Charging the device	13	14.4	Environment	47
5.3	Ensuring the degree of protection	15	14.5	Mechanical construction	48
6	Operation options	16	Index		50
6.1	Overview of operation options	16			
6.2	Internal operating menu with keys	16			
6.3	Operation via SmartBlue app	20			
7	Commissioning	25			
7.1	Preliminaries	25			
7.2	Function check	25			
7.3	Switching on the device	25			
7.4	Setting the display language	26			
7.5	Configuring the measuring device	26			
7.6	Advanced settings	26			
8	Operation	32			
8.1	Calibration	32			
8.2	Reading measured values	32			
9	Firmware update	40			

1 About this document

1.1 Warnings

Structure of information	Meaning
 <p>Causes (/consequences) If necessary, Consequences of non-compliance (if applicable) ▶ Corrective action</p>	<p>This symbol alerts you to a dangerous situation. Failure to avoid the dangerous situation will result in a fatal or serious injury.</p>
 <p>Causes (/consequences) If necessary, Consequences of non-compliance (if applicable) ▶ Corrective action</p>	<p>This symbol alerts you to a dangerous situation. Failure to avoid the dangerous situation can result in a fatal or serious injury.</p>
 <p>Causes (/consequences) If necessary, Consequences of non-compliance (if applicable) ▶ Corrective action</p>	<p>This symbol alerts you to a dangerous situation. Failure to avoid this situation can result in minor or more serious injuries.</p>
 <p>Cause/situation If necessary, Consequences of non-compliance (if applicable) ▶ Action/note</p>	<p>This symbol alerts you to situations which may result in damage to property.</p>

1.2 Symbols

Symbol	Meaning
	Additional information, tips
	Permitted or recommended
	Not permitted or not recommended
	Reference to device documentation
	Reference to page
	Reference to graphic
	Result of a step

1.3 Symbols on the device

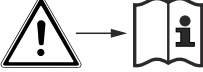
Symbol	Meaning
 The symbol consists of two parts. On the left is a warning symbol: a triangle with a thick border and a large exclamation mark inside. A horizontal arrow points from the right side of the triangle to the left side of the second symbol. The second symbol is an information symbol: an open book with a lowercase letter 'i' inside, representing information.	Reference to device documentation

2 Basic safety instructions

2.1 Requirements for the personnel

- Installation, commissioning, operation and maintenance of the measuring system may be carried out only by specially trained technical personnel.
- The technical personnel must be authorized by the plant operator to carry out the specified activities.
- The electrical connection may be performed only by an electrical technician.
- The technical personnel must have read and understood these Operating Instructions and must follow the instructions contained therein.
- Faults at the measuring point may only be rectified by authorized and specially trained personnel.

 Repairs not described in the Operating Instructions provided must be carried out only directly at the manufacturer's site or by the service organization.

 The battery may only be changed directly at the manufacturer's premises or by the service organization.

2.2 Intended use

The Liquiline Mobile CML18 is a multiparameter mobile device for the connection of digital sensors with Memosens technology and optional operation by smartphone or other mobile devices via Bluetooth.

The device is designed for use in the following industries:

- Life science
- Chemical industry
- Water and wastewater
- Food and beverages
- Power stations
- Other industrial applications

 The device contains a lithium ion battery. For this reason, the device may only be exposed to the operating and storage temperatures indicated.

The device may not be exposed to mechanical shocks of any kind.

The device may not be operated under water.

2.3 Workplace safety

As the user, you are responsible for complying with the following safety conditions:

- Installation guidelines
- Local standards and regulations
- Regulations for explosion protection

2.4 Operational safety

Before commissioning the entire measuring point:

1. Verify that all connections are correct.
2. Ensure that electrical cables and hose connections are undamaged.
3. Do not operate damaged products, and protect them against unintentional operation.
4. Label damaged products as defective.

During operation:

- ▶ If faults cannot be rectified:
products must be taken out of service and protected against unintentional operation.

2.5 Product safety

2.5.1 State-of-the-art technology

The product is designed to meet state-of-the-art safety requirements, has been tested, and left the factory in a condition in which it is safe to operate. The relevant regulations and international standards have been observed.

3 Product description

3.1 Product design

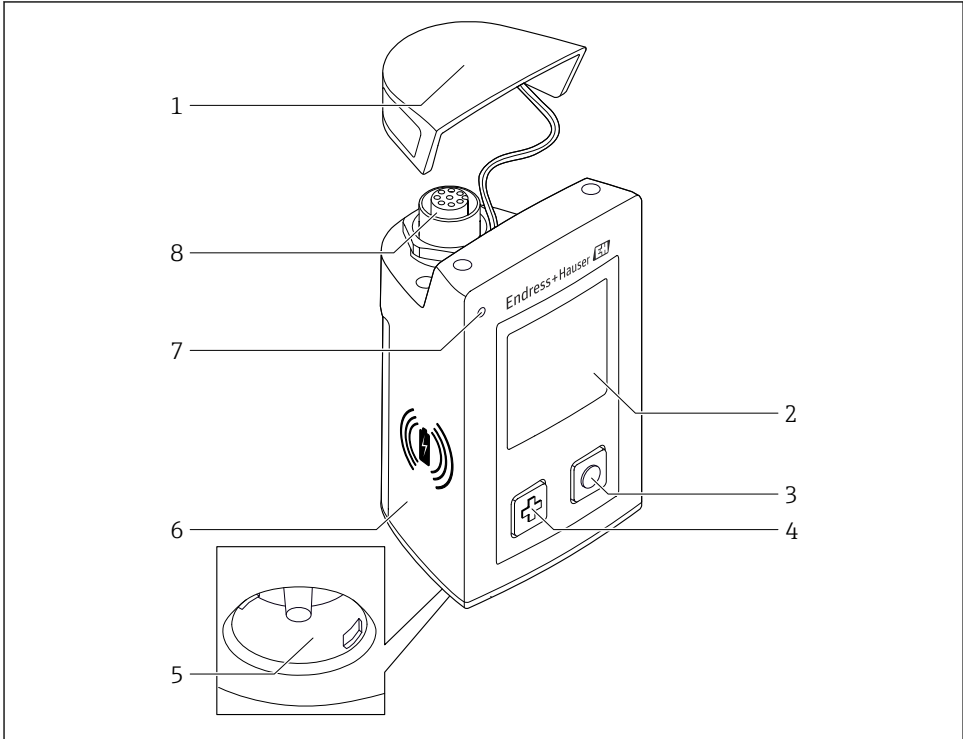

A0040968

1 CML18

- 1 Protection cap
- 2 Display screen with automatic screen rotation
- 3 "Select" button
- 4 "Next" button
- 5 Memosens connection
- 6 Area for wireless charging
- 7 Status LED
- 8 M12 connection

3.1.1 Measuring parameters

The mobile device is designed for digital Memosens sensors with an inductive plug-in head and fixed cable sensors with the Memosens protocol and no external power supply:

- pH
- ORP
- pH/ORP combination sensors
- Conductive conductivity
- Inductive conductivity
- Dissolved oxygen (optical/amperometric)

In addition to measuring the main parameters, Memosens sensors can be used to measure temperature.

The measuring range is adapted to the individual sensor type.

4 Incoming acceptance and product identification

4.1 Incoming acceptance

1. Verify that the packaging is undamaged.
 - ↳ Notify the supplier of any damage to the packaging.
Keep the damaged packaging until the issue has been resolved.
2. Verify that the contents are undamaged.
 - ↳ Notify the supplier of any damage to the delivery contents.
Keep the damaged goods until the issue has been resolved.
3. Check that the delivery is complete and nothing is missing.
 - ↳ Compare the shipping documents with your order.
4. Pack the product for storage and transportation in such a way that it is protected against impact and moisture.
 - ↳ The original packaging offers the best protection.
Make sure to comply with the permitted ambient conditions.

If you have any questions, please contact your supplier or your local Sales Center.

4.2 Product identification

4.2.1 Nameplate

The nameplate contains the following information:

- Manufacturer identification
- Device designation
- Order code
- Serial number
- Protection class
- Ambient and process conditions
- Input and output values

- ▶ Compare the information on the nameplate with the order.

4.2.2 Product identification

Product page

www.endress.com/CML18

Interpreting the order code

The order code and serial number of your product can be found in the following locations:

- On the nameplate
- In the delivery papers

Obtaining information on the product

1. Go to www.endress.com.

2. Call up the site search (magnifying glass).
3. Enter a valid serial number.
4. Search.
 - ↳ The product structure is displayed in a popup window.
5. Click on the product image in the popup window.
 - ↳ A new window (**Device Viewer**) opens. All of the information relating to your device is displayed in this window as well as the product documentation.

Manufacturer's address

Endress+Hauser Conducta GmbH+Co. KG
Dieselstraße 24
D-70839 Gerlingen

4.3 Scope of delivery

The scope of delivery comprises:

- 1 Liquiline Mobile CML18
- 1 set of Operating Instructions in German
- 1 set of Operating Instructions in English



Inductive charger and power unit are available separately.

- ▶ If you have any queries:
Please contact your supplier or local sales center.

5 Electrical connection

5.1 Connecting the sensor

5.1.1 Connecting the Memosens sensor directly

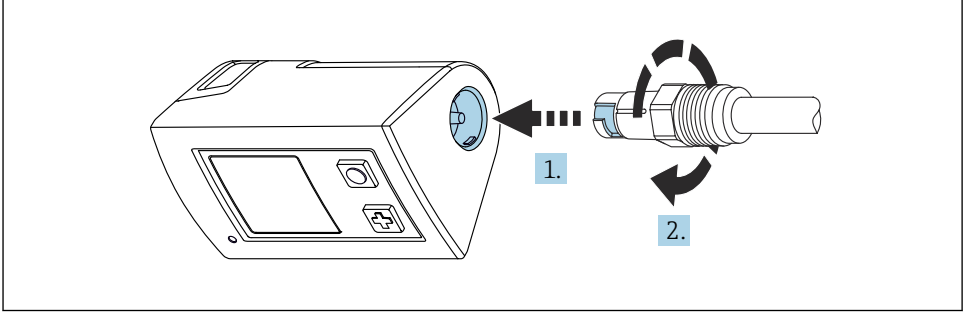

A0040973

2 Sensor connection

1. Insert the sensor into the Memosens connection.
2. Click the Memosens connection into place.

5.1.2 Connecting the Memosens sensor with M12 fixed cable connection

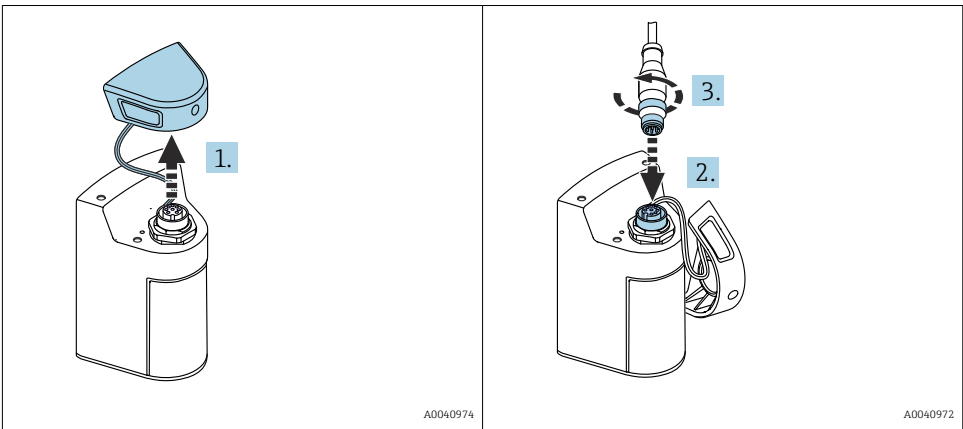

A0040974

A0040972

1. Remove the protection cap.
2. Insert the M12 fixed cable.
3. Screw on the M12 fixed cable.

5.1.3 Connecting the sensor via the Memosens M12 cable

The M12 cable has two different connectors:

- M12 connector for connecting to the device
- Memosens connection for connecting a Memosens sensor

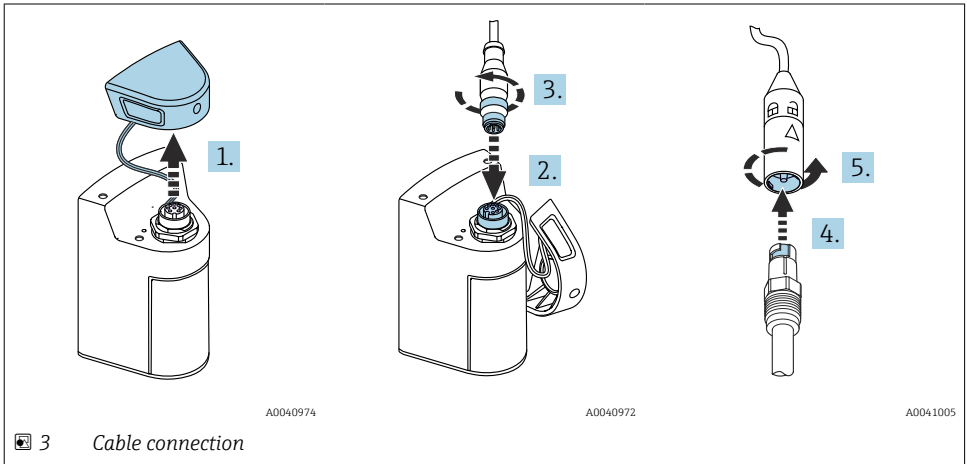

1. Remove the protection cap.
2. Insert the M12 connector.
3. Screw on the M12 connector.
4. Insert the sensor into the Memosens connection.
5. Click the Memosens connection into place.

5.2 Charging the device

i Charge the device fully before initial commissioning.

There are two possible ways to load the device:

- wirelessly via Qi-certified charger
- via cable with M12 USB data + charging cable

The following applies to both options:

- When device is switched on:
 - When charging starts, a flash symbol appears on the display and a confirmation tone sounds.
 - If charging stops before the battery is fully charged, another confirmation tone sounds.
 - When charging is complete, the "charging complete" melody sounds.
- When device is switched off:
 - The green LED flashes during charging.
 - When charging is complete, the "charging complete" melody sounds and the LED is continuously lit green for 10 minutes.
 - The device then switches off.

5.2.1 Charging via Qi charger

 Only use Qi-certified chargers (Qi version 1.2)!

Further information: www.wirelesspowerconsortium.com

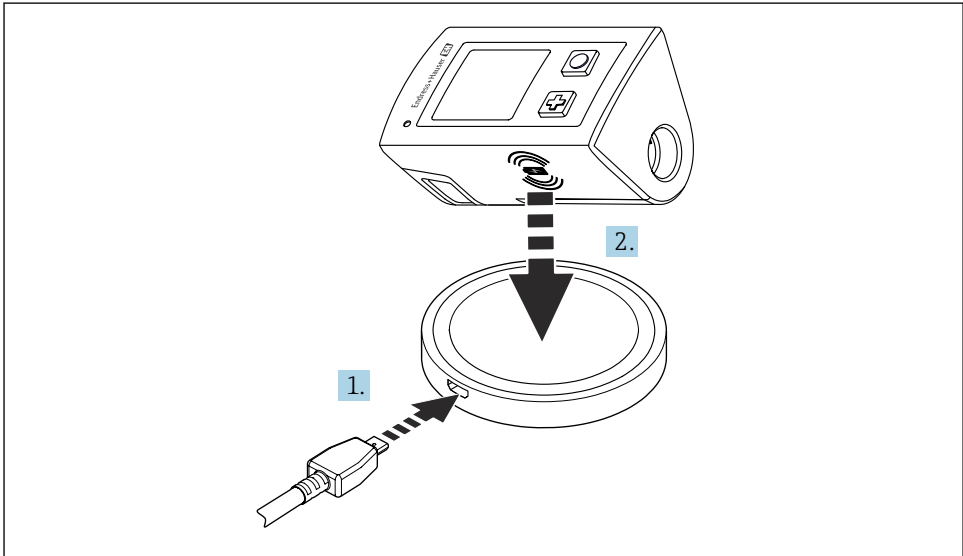

A0044052

4 Inductive charging

1. Connect the charger to the power source.
2. Place the device with the charging side on the charger.

Charging begins and the charging state is indicated on the display.

An acoustic signal indicates that charging is complete.

i During inductive charging, measurement via the integrated Memosens connection on the device is not possible.

A message to this effect is shown on the display.

Measurement via M12 cable is still possible.

5.2.2 Charging via M12 USB data + charging cable

The M12 USB data + charging cable has two different connectors:

- M12 connector for connecting to the device
- USB connector for connecting to a computer or USB charger

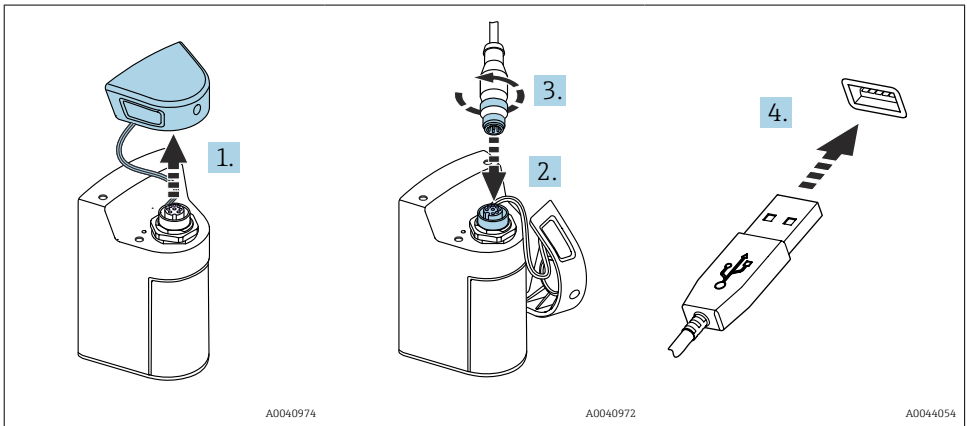

1. Remove the protective cap.
2. Attach the M12 connector of the cable to the device connection.
3. Screw on the M12 connector of the cable.
4. Connect the USB connector to a USB charger or USB port on a computer.

5.3 Ensuring the degree of protection

Only the mechanical and electrical connections which are described in these instructions and which are necessary for the required, designated use, may be carried out on the device delivered.

- ▶ Exercise care when carrying out the work.

Otherwise, the individual types of protection (Ingress Protection (IP), electrical safety, EMC interference immunity) agreed for this product can no longer be guaranteed due, for example to covers being left off or cable (ends) that are loose or insufficiently secured.

6 Operation options

6.1 Overview of operation options

There are two options for operating and configuring the device:

- Internal operating menu with keys
- SmartBlue app via Bluetooth® LE wireless technology → 📄 20

6.2 Internal operating menu with keys

6.2.1 Display and operating elements

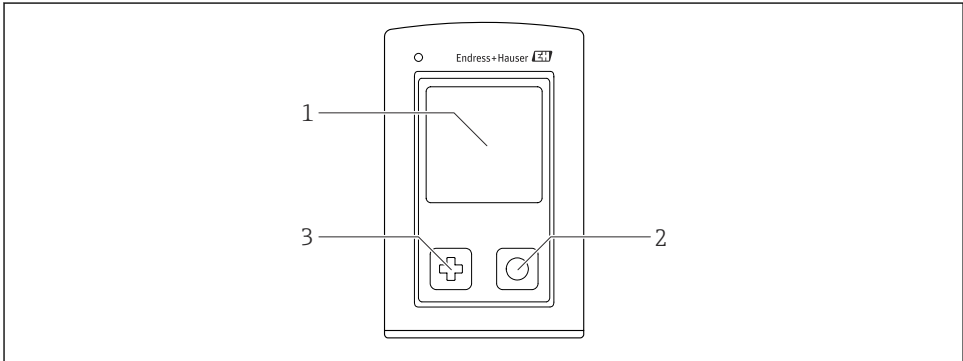

A0040996

📄 5 Overview of display and operating elements

- 1 Display
- 2 "Select" button
- 3 "Next" button

Button functions

Button	Device switched off	On measuring screen	In the menu
⊕	Switching on	Scroll through measuring screens	Scroll down
⊙	Switching on	Save current measured values (Grab Sample)	Confirm/select
⊕ (long hold)	-	Open the menu	Switch to previous menu level/measuring screen
⊕ + ⊙ (pressed for longer than 7 seconds)	Forced hardware reset	Forced hardware reset	Forced hardware reset

6.2.2 Structure and function of the operating menu

Power-off	
Power-off	▶▶

Application			
Data logger	▶	Data logger	▶▶
		Log interval	▶▶
		Cond. unit	▶▶
		Res. unit	▶▶
		Erase data	▶
		Erase grab values	▶
		Abort	▶▶
		Erase	▶▶
		Erase continuous logs	▶
		Abort	▶▶
		Erase	▶▶
Data logger plot	▶▶		
Units	▶▶		

Diagnostics		
Sensor info	▶▶	
Calibration info	▶▶	
Diagnostics list	▶▶	
Data logger entries	▶▶	
Display test	▶▶	
Device info	▶	
	Manufacturer	▶▶
	Software version	▶▶
	Serial number	▶▶
	Description	▶▶
	Extended order code	▶▶

System/Language	
Display language	▶▶
Bluetooth	▶▶
Display brightness	▶▶
Signal sounds	▶▶
M12 CSV	▶▶

System/Language	
Power management	▶ Power save w. charger ▶▶
	Power save w/o charger ▶▶
	Power-off w. charger ▶▶
	Power-off w/o charger ▶▶
Regulatory information	▶▶

Support links	
Support links	▶▶

Guidance	
1 point calib. (ORP)	▶▶
2 point calibration (pH and ISFET)	▶▶
Cell constant (inductive/conductive conductivity)	▶▶
Installation factor (conductive conductivity)	▶▶
Air 100% rh (oxygen)	▶▶
Air variable (oxygen)	▶▶
1 point calib. (oxygen)	▶▶

Display structure

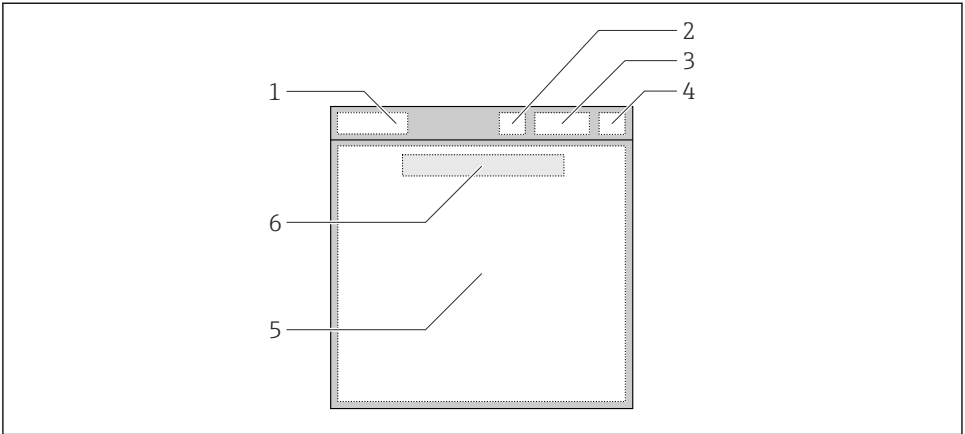

A0044047

6 Schematic representation of the display structure

- 1 Menu path/title of measuring screen
- 2 Bluetooth status
- 3 Battery level, charging information
- 4 NAMUR indicator
- 5 Measuring screen
- 6 Date and time (displayed in main menu and if no sensor is connected)

Status according to NAMUR NE107 categories:

NAMUR indicator	Status
OK	The device and sensor are working reliably.
F	Failure of device or sensor. F status signal as per NAMUR NE107
M	Device or sensor requires maintenance. M status signal as per NAMUR NE107
C	Device or sensor undergoing function check. C status signal as per NAMUR NE107
S	Device or sensor being operated out of specification. S status as per NAMUR NE107

Structure of the measurement window

The measurement window has 3 measuring screens, which the user can scroll through:

Measuring screen (1 of 3)	Measuring screen (2 of 3)	Measuring screen (3 of 3)
Main value	Main and secondary measured value	All measured values of the sensor input

6.2.3 LED status indicator

The status LED is used for the quick visualization of the sensor status.

LED behavior	Status
Solid green	Sensor working correctly
Solid red	No sensor connected
Flashes red	Sensor error

6.3 Operation via SmartBlue app

The SmartBlue App is available for download from the Google Play Store for Android devices and from the Apple App Store for iOS devices.

Download the SmartBlue App.

- Use the QR codes to download the app.

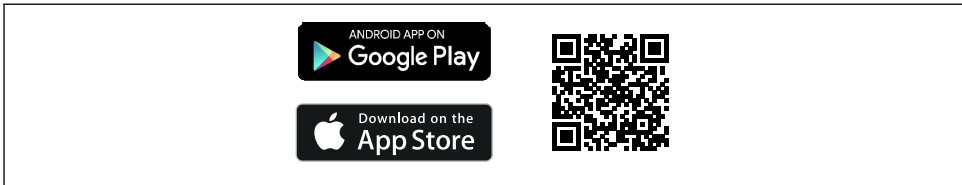

A0033202

 7 *Download links*

System requirements

- iOS devices: iPhone 4S or higher from iOS9.0; iPad2 or higher from iOS9.0; iPod Touch 5th generation or higher from iOS9.0
 - Devices with Android: from Android 4.4 KitKat and Bluetooth® 4.0
 - Internet access
- Open the SmartBlue App.



A0029747

8 SmartBlue App icon

i Bluetooth must be enabled on both devices.

Enable Bluetooth → 26

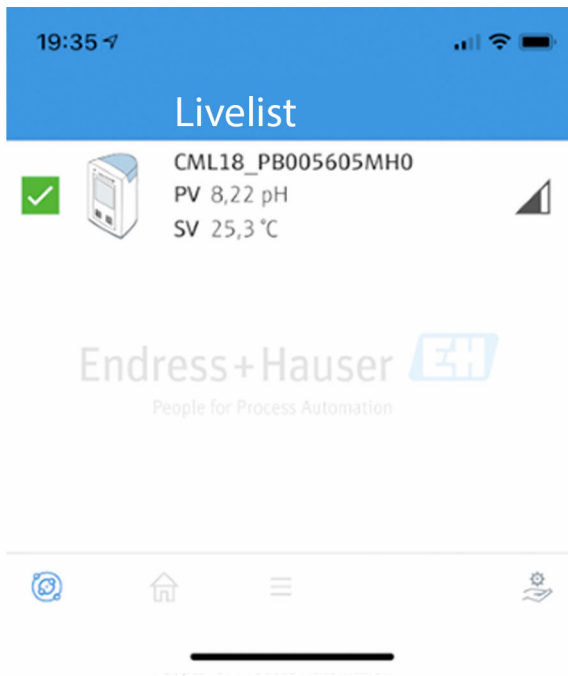

A0044142

9 SmartBlue App Livelist

The Livelist displays all of the devices that are within range.

► Tap the device to select it.

i To be able to use the device with the SmartBlue App, the Bluetooth connection must be confirmed by entering a user name and password.

1. User name >> **admin**
2. Initial password >> **device serial number**

Change the user name and password after logging in for the first time.

The current measured values are displayed in the Home view. The device information (device tag, serial number, firmware version, order code) is also displayed.

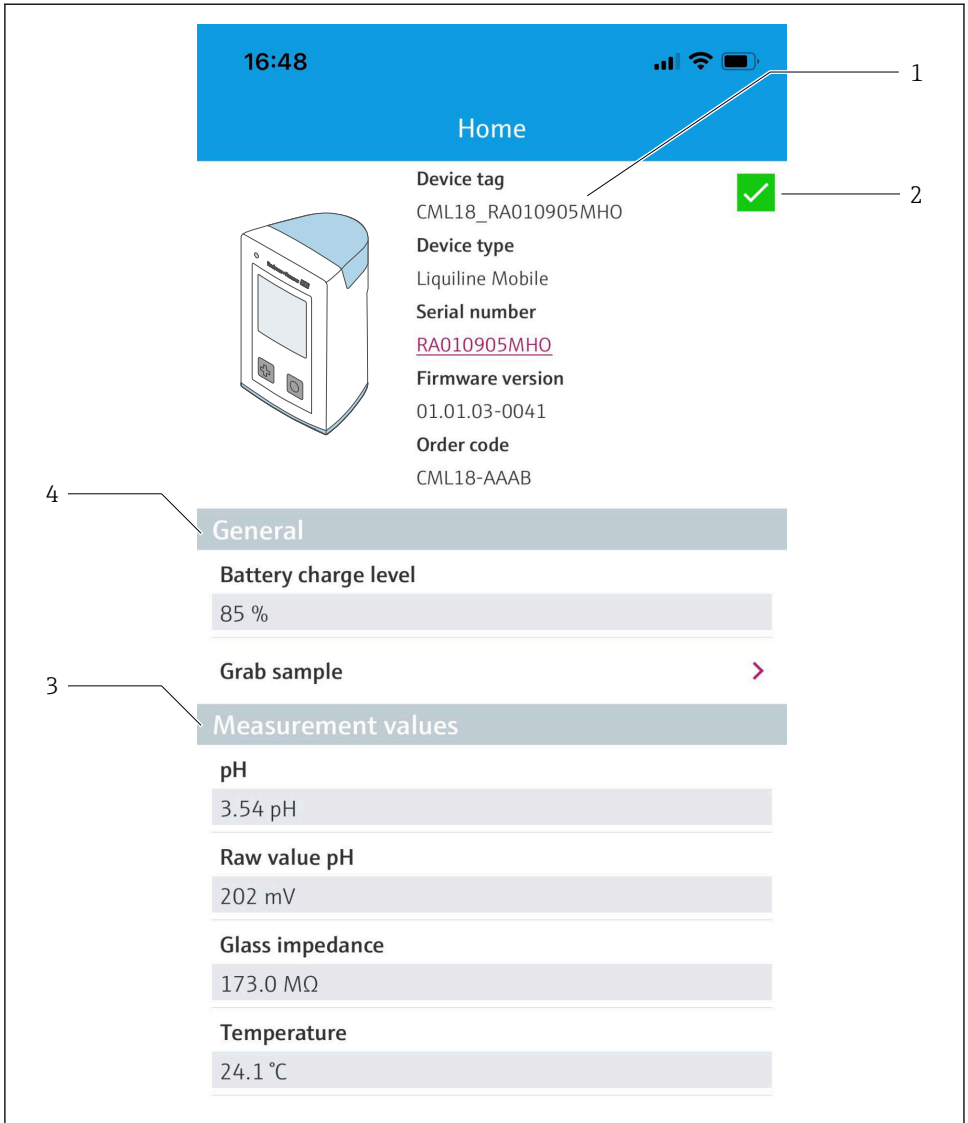

A0048102

10 Home view of SmartBlue App with current measured values

- 1 CML18 system and device information
- 2 Shortcut to diagnostic list
- 3 Overview of measured values of connected sensor
- 4 General information and sampling option

Operation is via 4 main menus:

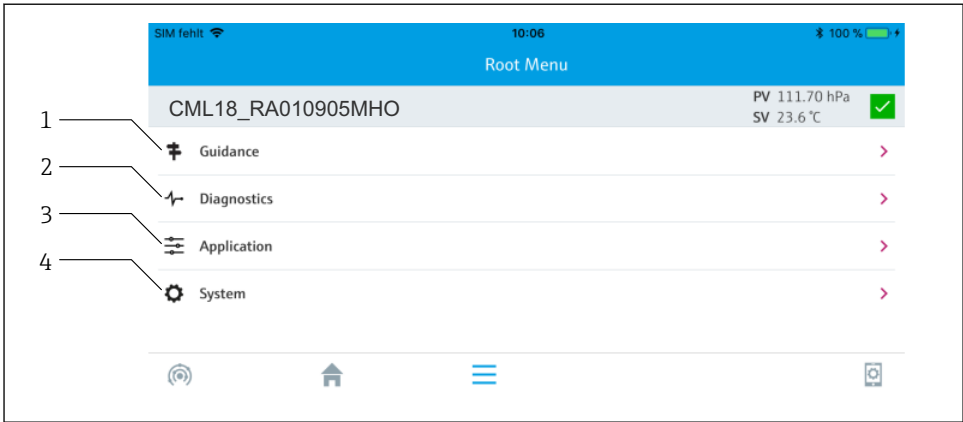

A0048103

11 Main menus of the SmartBlue App

- 1 Guidance
- 2 Diagnostics
- 3 Application
- 4 System

Menu	Function
Guidance	Contains functions involving a self-contained sequence of activities, e.g. for calibration (= "Wizard", guided operation).
Diagnostics	Contains information on operation, diagnostics and troubleshooting, as well as configuration of the diagnostic behavior.
Application	Sensor data for specific optimization and for detailed process adjustment. Adapts the measuring point to the application.
System	These menus contain parameters for configuring the overall system, e.g. Time and date options.

7 Commissioning

7.1 Preliminaries

Charge the device fully before initial commissioning. →  12

Connect the sensor. →  12

7.2 Function check

WARNING

Connection errors

The safety of people and of the measuring point is at risk!

- ▶ Put the device into operation only if you can answer **yes to all** the following questions.

Device condition and specifications

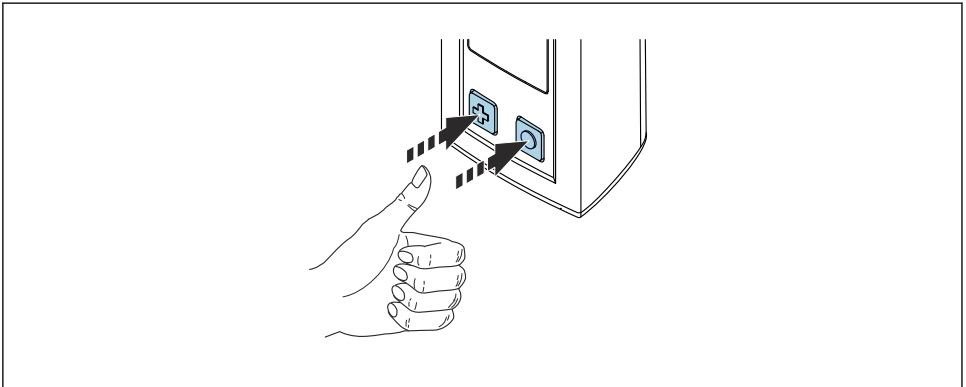

- ▶ Are the device and all the cables free from damage on the outside?
- ▶ Are the mounted cables strain relieved?
- ▶ Are the cables routed without loops and cross-overs?

7.3 Switching on the device



A0040976

 12 *Switching on the device*

- ▶ Press  or .
- ↳ The device starts up.

A connected sensor is recognized automatically.

The time required before a measured value is displayed depends on the sensor type and measuring principle and can vary.

7.4 Setting the display language

1. Navigate to: **Display language**
↳ **Main menu >> System/Language >> Display language**
2. Press  to scroll through the predefined values.

Description of setting	Configuration options
Change the language of the operating menu.	<ul style="list-style-type: none"> ▪ Deutsch ▪ English

7.5 Configuring the measuring device

7.5.1 Configuring the Bluetooth connection

1. Navigate to: **Bluetooth**
↳ **Main menu >> System/Language >> Bluetooth**
2. Press  to scroll through the predefined values.



Description of setting	Configuration options
Switch Bluetooth connection on/off	<ul style="list-style-type: none"> ▪ Enabled ▪ Disabled



If the Bluetooth connection is disabled, operation via the SmartBlue App is not possible.

7.5.2 Setting date and time

Preparatory steps

1. Enable Bluetooth. →  26
 2. Link the device to a mobile terminal via the SmartBlue app. →  20
1. Select the device in the SmartBlue App.
 2. Select **System**.
 3. Select **date/time**.
 4. Select **Take over from mobile device**.
↳ or:
 5. Manually configure the date and time.

7.6 Advanced settings

7.6.1 Displaying device information

1. Navigate to: **Device info**
↳ **Main menu >> Diagnostics >> Device info**

2. Press  to scroll through the **Device info**.

The following information about the device is shown on the display:

- Manufacturer identification
- Software version
- Serial number
- Designation
- Extended order code

7.6.2 Adjusting the energy settings



A maximum battery life of 48 h can be achieved via the energy settings.

For measurements with oxygen sensors, the device remains permanently switched on, regardless of the energy settings selected.

1. Navigate to: **Power management**
 ↳ **Main menu >> System/Language >> Power management**

2. Press  to scroll through the predefined values.

The following energy settings are available:

- Power save w. charger
- Power save w/o charger
- Power-off w. charger
- Power-off w/o charger



The power save mode is activated after the set time if there is no user interaction.

In the power save mode, the display is switched off and the device remains on standby.

There are 2 power save settings:

Power save w. charger

Description of setting	Configuration options
Set the time until the power save mode is activated if the device is connected to the mains.	<ul style="list-style-type: none"> ■ 1 min ■ 5 min ■ 15 min ■ 30 min ■ 1 h ■ 2 h ■ Never

Power save w/o charger

Description of setting	Configuration options
Set the time until the power save mode is activated if the device is running on the battery.	<ul style="list-style-type: none"> ▪ 1 min ▪ 5 min ▪ 15 min ▪ 30 min ▪ 1 h



The device is automatically switched off after the selected time.

The device is not switched off automatically if the Bluetooth connection is enabled.

There are 2 power-off settings:

Power-off w. charger

Functional description	Configuration options
Set the time until the device switches off automatically if it is connected to the mains.	<ul style="list-style-type: none"> ▪ 1 min ▪ 5 min ▪ 15 min ▪ 30 min ▪ 1 h ▪ 2 h ▪ Never

Power-off w/o charger

Functional description	Configuration options
Set the time until the device switches off automatically if it is running on the battery.	<ul style="list-style-type: none"> ▪ 1 min ▪ 5 min ▪ 15 min ▪ 30 min ▪ 1 h ▪ 2 h ▪ Never

7.6.3 Signal sounds

1. Navigate to: **Signal sounds**
 - ↳ **Main menu >> System/Language >> Signal sounds**
2. Press to scroll through the predefined values.
 - ↳ Other settings are possible via the SmartBlue App.

Description of setting	Configuration options
Switch signal sounds on/off	<ul style="list-style-type: none"> ▪ Enabled ▪ Disabled



Additional changes to the signal sounds can be made via the SmartBlue App.

7.6.4 Configuring M12 CSV

Measured values can be output to other devices via the device's M12 connection. The M12 USB data + charging cable → 45 is used for this purpose. The transmitted data can, for example, be further processed in real-time in an external computer program.

A data rate of 9600 bit/s in 8N1 configuration must be used as the connection parameter at the receiving system.

1. Navigate to: **M12 CSV**
 - ↳ **Main menu >> System/Language >> M12 CSV**
2. Press to scroll through the predefined values.

Description of setting	Configuration options
Switch on/off M12 CSV	<ul style="list-style-type: none"> ▪ On ▪ Off



When the M12 CSV option is enabled, no sensor can be operated via cable. Operation via the Memosens connection on the device is still possible.

A message to this effect is shown on the display.

7.6.5 Adjusting the display brightness

1. Navigate to: **Display brightness**
 - ↳ **Main menu >> System/Language >> Display brightness**
2. Press to adjust the display brightness.

Description of setting	Configuration options
Set the display brightness	<ul style="list-style-type: none"> ▪ Low ▪ Medium ▪ High ▪ Maximum

7.6.6 Hardware reset in an emergency



This type of restart should only be performed in an emergency if the device does not respond to any other input.

- ▶ Press and hold and simultaneously for at least 7 seconds.
 - ↳ The device restarts.

7.6.7 Displaying regulatory information and approvals

1. Navigate to: **Regulatory information**
↳ **Main menu >> System/Language >> Regulatory information**
2. Press  to display regulatory information and approvals.

7.6.8 Data logger

Defining the log interval

 The log interval can only be changed if the data logger is deactivated.

1. Navigate to: **Log interval**
↳ **Main menu >> Application >> Data logger >> Log interval**
2. Press  to scroll through the predefined values.

Description of setting	Configuration options
Set the time until the next measured value is saved automatically.	<ul style="list-style-type: none"> ▪ 1 s ▪ 2 s ▪ 10 s ▪ 20 s ▪ 30 s ▪ 1 min ▪ 5 min ▪ 30 min ▪ 1 h

 If the device is woken up to record a log value, any existing switch-on / settling times of the connected sensor are not taken into account.

When measuring with oxygen sensors, such as the Oxymax COS51D or COS22D, the device with activated data logger remains permanently switched on, regardless of the energy settings selected.

Adjust the energy settings: →  27

Enabling/disabling the data logger

 The data logger must be deactivated in the following cases:

- if changes are made to the measurement settings
- if the measured values are exported
- if the sensor is replaced

1. Navigate to: **Data logger**
↳ **Main menu >> Application >> Data logger >> Data logger**
2. Press  to scroll through the predefined values.



Description of setting	Configuration options
Enable/disable automatic data logger	<ul style="list-style-type: none"> ▪ On ▪ Off

3. Exit the menu.
4. Once activated, the data logger automatically starts recording the measured values.
 - ↳ If the data logger is activated, the display flashes alternately between the "**Logging...**" message and the current menu path/measuring screen title.
4. Press  to change the active measuring window.

Configuring the data logger for ultrapure water

Prior to activating the data logger, the measured value units can be adjusted for conductivity measurement with the data logger in ultrapure water. An adjustment is necessary to eliminate rounding errors in the smallest measured values.

The units for conductivity and resistance can be permanently configured.

1. Navigate to: **Cond. unit**
 - ↳ **Main menu >> Application >> Data logger >> Data logger >> Cond. unit**
2. Press  to scroll through the predefined values.
1. Navigate to: **Res. unit**
 - ↳ **Main menu >> Application >> Data logger >> Data logger >> Res. unit**
2. Press  to scroll through the predefined values.

7.6.9 Switching units



Only the units used by the sensor are displayed.



1. Navigate to: **Units**
 - ↳ **Main menu >> Application >> Units**
2. Press  to scroll through the predefined values.

8 Operation

8.1 Calibration

To calibrate sensors, the calibration settings are first configured via the SmartBlue app. The calibration can then be started from the device.

Configure the calibration settings in the SmartBlue app:

1. Enable Bluetooth. →  26
2. Link the device to a mobile terminal via the SmartBlue app. →  20
3. Select the device in the SmartBlue App.
4. Navigate to: **Calibration settings**
 - ↳ **Application** >> **Sensor** >> **Advanced settings** >> **Calibration settings**
5. Configure the calibration settings.
 - ↳ e.g. Manufacturer and calibration buffer.

Perform calibration on the device:

1. Navigate to: **Guidance**
 - ↳ Select the desired calibration.
2. Press  to navigate through the calibration.

The following calibrations can be performed:

Type of calibration	Measuring parameters	Navigate to:
1-point calibration	ORP	>> 1 point calib.
2-point calibration	pH or ISFET	>> 2 point calibration
Cell constant calibration	Inductive/conductive conductivity	>> Cell constant
Installation factor calibration	Conductive conductivity	>> Installation factor
Air 100%rH calibration	Oxygen	>> Air 100% rh
Air variable calibration	Oxygen	>> Air variable
1-point calibration	Oxygen	>> 1 point calib.

8.2 Reading measured values

Measuring screens are shown on the display when a sensor is connected.

For each sensor, there are 3 measuring screens with different measured variables →  19.

To scroll through the measuring screens:

- ▶ Press .

After the last measuring screen, the display returns to the first measuring screen.

8.2.1 Saving the sample (Grab Sample)

Samples can be assigned IDs and a user-definable text. By assigning an ID, samples can be assigned more easily to a measuring point, for example.



IDs and the associated texts can be changed via the SmartBlue App. → 33

1. In the measurement window, press .
 - ↳ A new window appears.
2. Give the sample an ID.
 - ↳ Press to scroll through the available IDs.
3. Press to save the sample with the selected ID.
 - ↳ Or: Press and hold to discard the sample.

8.2.2 Changing the sample IDs

The 10 pre-set IDs for samples can be changed via the SmartBlue App.

Preparatory steps

1. Enable Bluetooth. → 26
2. Link the device to a mobile terminal via the SmartBlue app. → 20

Transferring the data

1. Select the device in the SmartBlue App.
2. Select **Grab sample**.
3. Select ID text.
 - ↳ Click in the line of text to assign an individual text for the selected ID.



Depending on the input language selected, there are up to 32 characters available for the assignment of the individual ID.

8.2.3 Saving measured values automatically (Data logger)

Configure the data logger → 30.

8.2.4 Displaying saved measured values

- ▶ Navigate to: **Log entries**
 - ↳ **Main menu >> Diagnostics >> Log entries**

This menu displays the number of saved entries for the different log procedures.

8.2.5 Exporting measured values

Export to mobile terminal device

Saved data can be transferred from the internal device memory to mobile terminals.

Preparatory steps

1. Install the SmartBlue app on a mobile terminal. → 📄 20
2. Enable Bluetooth. → 📄 26
3. Link the device to a mobile terminal via the SmartBlue app. → 📄 20

Transferring the data

1. Select the device in the SmartBlue app.
2. Select ☰ in the SmartBlue app.

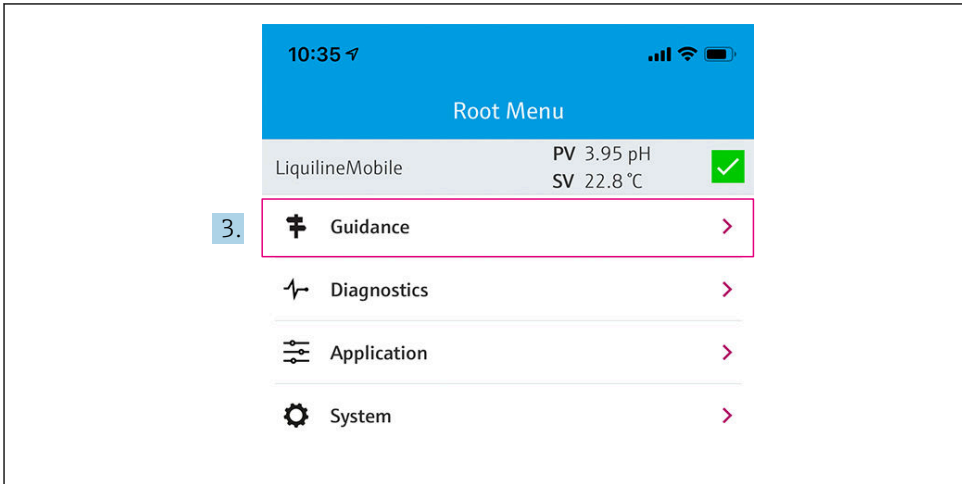

A0042257

3. Select **Guidance**.

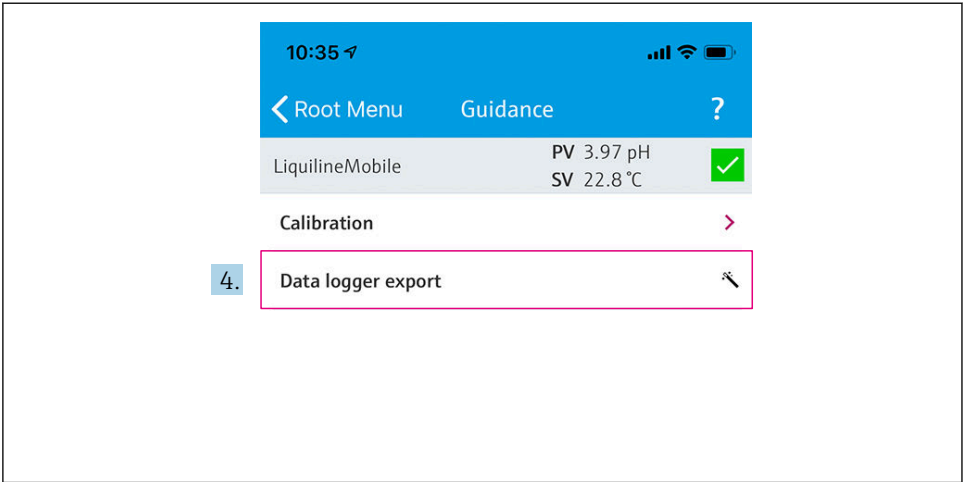

A0042258

4. Select **Data transfer**.

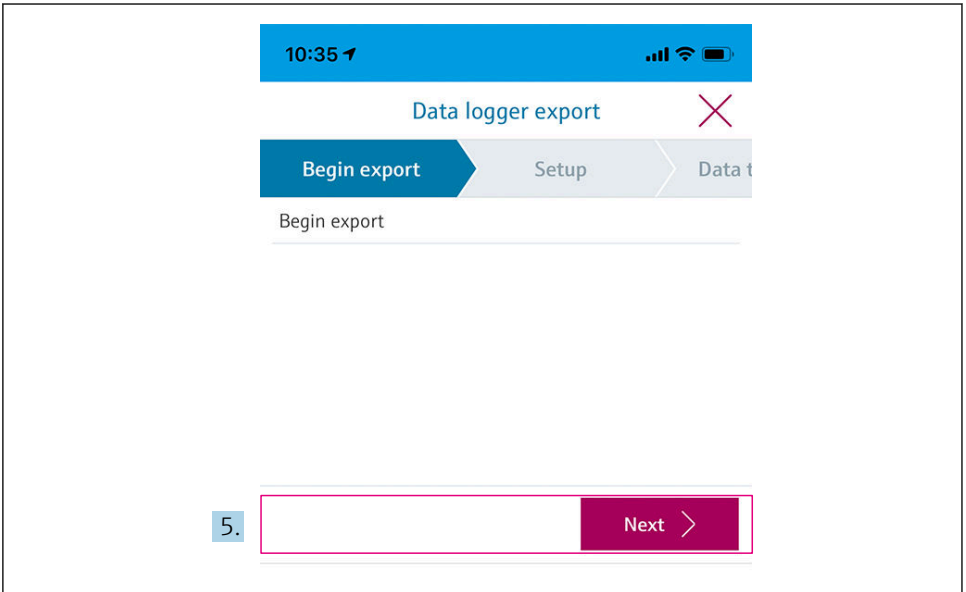

A0042261

5. Continue with **Next**.

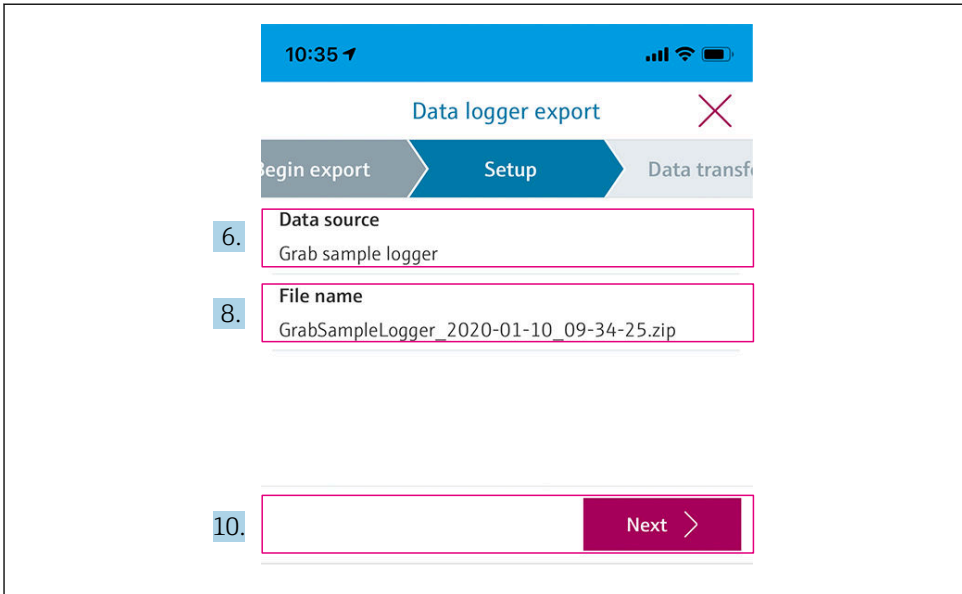

A0042260

6. Select **Data source**.
 - ↳ Select **Grab sample logger** for saved samples.
Select **Cont. data logger** for data records of data logger.
7. Press **Ok** to confirm.
 - ↳ Press **←** to discard changes and close the drop-down menu.
8. Select **File name**.
 - ↳ Click the text line to enter an individual name for the generated data package.
9. Press **Ok** to confirm.
 - ↳ Press **←** to discard changes and close the drop-down menu.
10. Press **Next** to continue.
 - ↳ Data transfer starts.
A progress bar indicates the progress percentage.

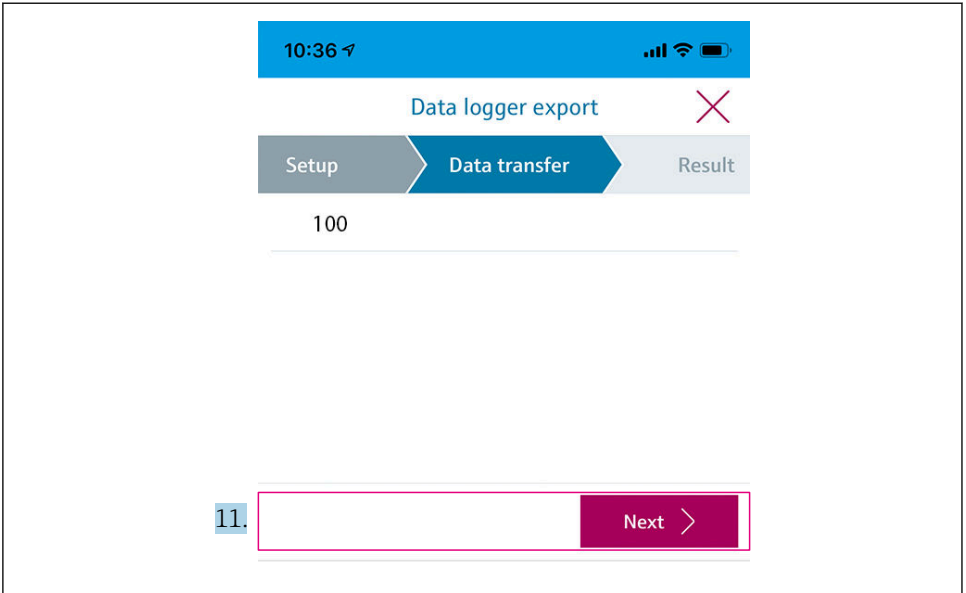

A0042265

- 11. When the transfer is complete, press **Next** to continue.
 - ↳ The result of the data transfer is displayed.

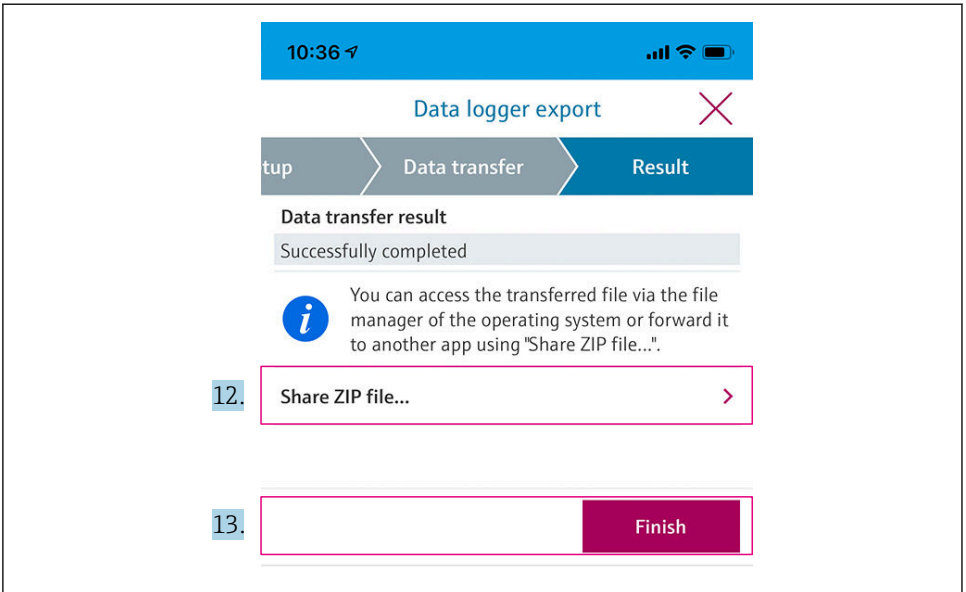

A0042265

12. Use **Share ZIP file...** to send the exported data records or save them locally.
13. Complete export by pressing **Finish**.

Exporting to a computer

Preparatory steps:

1. Download the CML18 readout tool to the target computer and save it.
 - ↳ The current readout tool can be found in the Download area on the product page under www.endress.com/CML18.
 2. Deactivate the data logger. → 📄 30
-
1. Remove all the sensors from the device.
 2. Connect the device to a computer via the M12 USB data + charging cable. → 📄 15
 3. Run the CML18 readout tool on the computer.
 4. Follow the instructions given by the tool.
 - ↳ The measured values are exported to an .xlsx file for table programs such as Microsoft Excel.

 The export files of the grab sample and data logger measured values have a different display format.

Elements of the export file	
Data logger export file	Grab sample export file
<p>Elements in the general information section of the export file:</p> <ul style="list-style-type: none"> ▪ Filename ▪ File content ▪ Format version ▪ Device type ▪ Device tag ▪ Device serial number ▪ Device firmware version ▪ Sensor serial number ▪ PV name ▪ PV unit ▪ SV name ▪ SV unit ▪ TV name ▪ TV unit <p>Elements of the individual measured value entries:</p> <ul style="list-style-type: none"> ▪ Sample number ▪ Status ▪ PV value ▪ SV value ▪ TV value ▪ Timestamp 	<p>Elements in the general information section of the export file:</p> <ul style="list-style-type: none"> ▪ Filename ▪ File content ▪ Format version ▪ Device type ▪ Device tag ▪ Device serial number ▪ Device firmware version <p>Elements of the individual measured value entries:</p> <ul style="list-style-type: none"> ▪ Sample number ▪ Status ▪ PV name ▪ PV value ▪ PV unit ▪ SV name ▪ SV value ▪ SV unit ▪ TV name ▪ TV value ▪ TV unit ▪ Timestamp ▪ Sensor serial number ▪ Sample ID

Description of the individual elements of the export files	
Filename	Name of the export file, based on the date/time of the first logged entry. If the sensor, sensor type or unit settings are changed, a new export file is created.
File content	Contents of the export file: <ul style="list-style-type: none"> ■ Data logger always "Continuous log" ■ Sample always "Grab sample logs"
Format version	Version of the format structure of the generated export file. The number increases if the structure changes with a new firmware.
Device type	Type of device used for logging. "Liquiline Mobile" in the case of CML18.
Device tag	Tag of the device used for logging.
Device serial number	Serial number of the device used for logging.
Device firmware version	Firmware version of the device used for logging.
Sample number	Unique entry number. This value is increased for each logged entry. It is reset if the entries are deleted.
Status	NAMUR device status when the entry is logged.
PV name	Name of the primary value.
PV value	Numerical display of the primary value of the logged entry.
PV unit	Unit of the primary value.
SV name	Name of the secondary value.
SV value	Numerical display of the secondary value of the logged entry.
SV unit	Unit of the secondary value.
TV name	Name of the tertiary value.
TV value	Numerical display of the tertiary value of the logged entry.
TV unit	Unit of the tertiary value.
Timestamp	Time and date stamp of the logged unit.
Sensor serial number	Serial number of the sensor used for logging.
Sample ID	User-defined text to identify the entry.

8.2.6 Deleting measured values

► Navigate to: **Erase data**

↳ **Main menu >> Application >> Data logger >> Erase data**





The data are divided into 2 categories:

- Erase continuous logs
Selects all data logger entries for deletion.
- Erase grab values
Selects all grab values (samples) for deletion.

NOTICE**Deletion of data!**

Once data are deleted, they cannot be restored. The deletion of data must be confirmed.

- ▶ Save data before deletion.

1. Press  to navigate to the desired category.
2. Press  to select the category to be deleted.
3. Press  to select **Erase** or **Abort**.
4. Press  to select **Erase** or **Abort**.

8.2.7 Switching off the device

1. Navigate to: **Power-off**
↳ **Main menu >> Power-off**
2. Press  to switch off the device.

9 Firmware update

The firmware of the device can be updated to the latest version via the Smartblue App.

 All saved data logger entries must be exported before each firmware update.

A firmware update can take up to one hour.

There must be sufficient battery charge; if necessary, connect the device to the mains.

→  13

The device is prevented from switching off automatically if is connected to the SmartBlue app.

NOTICE**Damage to firmware!**

Risk of incomplete update and limited functionality of the device.

- ▶ During a firmware update, do not switch off the device manually or disconnect it from the mobile terminal.



 A video tutorial on how to update the firmware is available on Endress+Hauser's YouTube channel via the following link or QR code: [Firmwareupdate CML18](#)





A0045926

 13 Scan the QR code to access the instruction video

Preparatory steps

1. Download the firmware update package and save to the terminal.
 - ↳ The current firmware update package can be found in the Downloads area on the product page at www.endress.com/CML18.
2. Enable Bluetooth. →  26
3. Link the device to a mobile terminal via the SmartBlue app. →  20

Starting a firmware update

1. Select the device in the SmartBlue App.
 2. Select  in the SmartBlue app.
 3. Select **System**.
 4. Select **Firmware update**.
 5. Search for the available firmware update package on the terminal device and select it.
 - ↳ If the update is not displayed, the firmware update package must be opened once using the SmartBlue App.
 6. Start the update.
 7. After updating the firmware successfully, update the time and date. →  26
-  Following a firmware update, Bluetooth functionalities are restarted in the background. This process may take some time. All other functions of the device can be used immediately.

10 Diagnostics and troubleshooting

10.1 Diagnostics information via the local display

10.1.1 Accessing sensor information

1. Navigate to: **Sensor info**
 - ↳ **Main menu >> Diagnostics >> Sensor info**
2. Press  to access the sensor information.



10.1.2 Accessing calibration information

1. Navigate to: **Calibration info**
 - ↳ **Main menu >> Diagnostics >> Calibration info**
2. Press  to access the calibration information.

10.1.3 Opening the diagnostics list

1. Navigate to: **Diagnostics list**
 - ↳ **Main menu >> Diagnostics >> Diagnostics list**
2. Press  to open the diagnostics list.

10.1.4 Display testing

1. Navigate to: **Display test**
 - ↳ **Main menu >> Diagnostics >> Display test**
2. Press  to invoke the screen test.
3. Press  to scroll through the test windows and check the display for damage.

11 Maintenance

11.1 Maintenance tasks

11.1.1 Cleaning

- ▶ Only clean with a damp cloth and commercially available cleaning agents.

The device is resistant to:

- Ethanol (for a short time)
- Soap-based household cleaning agents
- Dishwashing detergent

NOTICE

Cleaning agents not permitted

Damage to the housing surface or housing seal

- ▶ Do not use concentrated mineral acids or alkaline solutions for cleaning.
- ▶ Do not use organic cleaners such as acetone, benzyl alcohol, methanol, methylene chloride, xylene or concentrated glycerol cleaner for cleaning.
- ▶ Do not use high-pressure steam for cleaning.

11.2 Measuring and test equipment

Calibrated and adjusted sensors with Memosens technology save their calibration data directly in the sensor.

The sensors can be used as testing equipment thanks to this functionality.

The device can be used to display the measured values of such test equipment. Each connected sensor uses its own calibration data.

Using the SmartBlue App, a sensor can be calibrated, recalibrated and adjusted in a suitable testing medium directly at the device.

12 Repair

12.1 Return

The product must be returned if repairs or a factory calibration are required, or if the wrong product was ordered or delivered. As an ISO-certified company and also due to legal regulations, Endress+Hauser is obliged to follow certain procedures when handling any returned products that have been in contact with medium.

To ensure the swift, safe and professional return of the device:

- ▶ Refer to the website www.endress.com/support/return-material for information on the procedure and conditions for returning devices.

12.2 Disposal

The device contains electronic components. The product must be disposed of as electronic waste.

- ▶ Observe the local regulations.



If required by the Directive 2012/19/EU on waste electrical and electronic equipment (WEEE), the product is marked with the depicted symbol in order to minimize the disposal of WEEE as unsorted municipal waste. Do not dispose of products bearing this marking as unsorted municipal waste. Instead, return them to Endress+Hauser for disposal under the applicable conditions.



The battery cannot be replaced or removed by the end customer!

It may only be disposed of by trained staff.

13 Accessories

The latest list of accessories and all compatible Memosens sensors is provided on the product page:

www.endress.com/CML18

13.1 M12 USB data + charging cable

Order code: 71496600

- Charging via cable
- Data backup
- Live data transfer

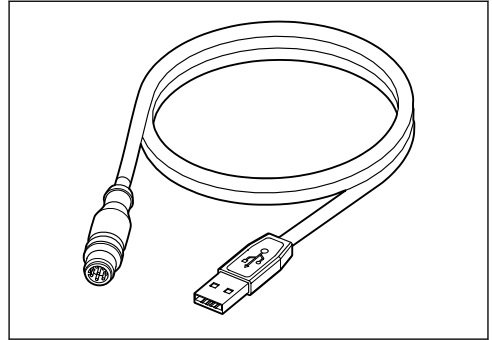

A0047709

13.2 Protective cover

Order code: 71530939

- Comprehensive protection
- Extremely robust
- Tabs and eyelets provide a range of securing options

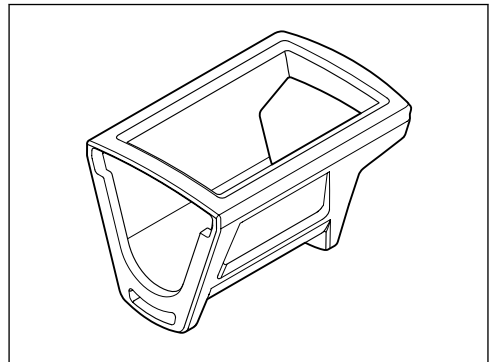

A0047710

14 Technical data

14.1 Input

14.1.1 Input power

Wireless charging	5 W
M12 connection	5 V; 0.6 A

14.1.2 Measured variables

- pH
- ORP
- pH/ORP
- Oxygen
- Conductivity
- Temperature

14.1.3 Measuring range

→ Documentation of the connected sensor

14.1.4 Type of input

Memosens connection for sensors with Memosens technology

M12 connection for digital measuring cable CYK10, CYK20 for sensors with Memosens technology

A complete list of supported sensors is provided on the device product page:

www.endress.com/CML18 -> Documents/Manuals/Software -> Certificates ...

Supported sensors from the lab portfolio include:

- CPL51E, CPL53E, CPL57E, CPL59E
- CLL47E
- COL37E

Supported sensors from the process portfolio include:

- CPS11D, CPS12D, CPS16D, CPS31D, CPS41D, CPS42D, CPS47D, CPS71D, CPS72D, CPS76D, CPS77D, CPS91D, CPS92D, CPS96D, CPS97D
- CPS171D, CPS341D, CPS441D, CPS471D, CPS491D
- CPF81D, CPF82D
- CLS15D, CLS16D, CLS21D, CLS82D
- CLS50D, CLS54D
- COS21D, COS22D, COS51D, COS81D

14.2 Output

14.2.1 Output signal

Memosens M12 (maximum 80 mA)

14.3 Power supply

14.3.1 Supply voltage

Inductive charging: use Qi-certified devices (min. 5 W output power)

The power supply unit must supply an output current of at least 1500 mA.

14.3.2 Battery rated capacity

1 000 mAh (min. 950 mAh)

14.3.3 Battery life

Max. 48 h (with adapted energy settings)

14.3.4 Overvoltage protection

IEC 61 000-4-4 with 0.6 kV

IEC 61 000-4-5 with 2.0 kV

14.3.5 Sensor connection

Sensors with Memosens technology

14.3.6 Cable specification

Digital measuring cable CYK10-Axx2+x

Digital measuring cable CYK20-AAxxC1

M12 USB data + charging cable

14.4 Environment

14.4.1 Ambient temperature range

Charging: 0 to +45 °C (32 to 113 °F)

Operation: -10 to +60 °C (14 to 140 °F)



The maximum ambient temperature depends on the process temperature and the installation position.

14.4.2 Storage temperature

-20 to +45 °C (-4 to 113 °F)



Elevated storage temperatures reduce the battery capacity.

14.4.3 Relative humidity

0 to 95 %

14.4.4 Degree of protection

IP66

14.4.5 Electrical safety

EN 61010-1

14.4.6 Pollution degree

Complete device:	Pollution level 4
Internal:	Pollution level 2

14.5 Mechanical construction

14.5.1 Dimensions

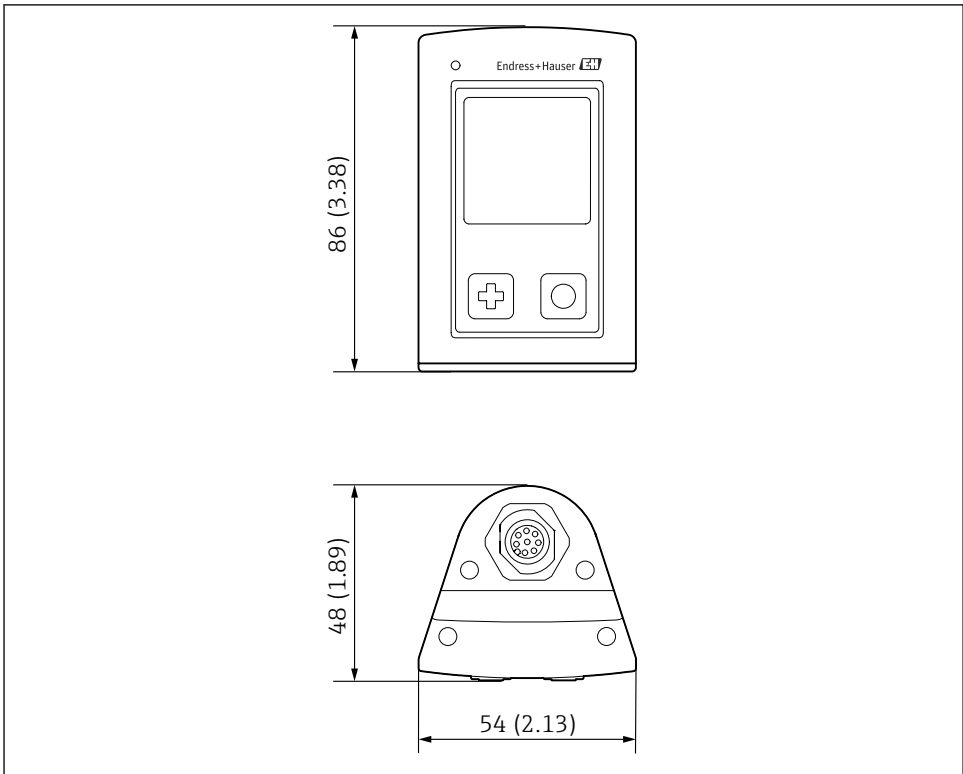

A0044044

14 Dimensions: mm (in)

14.5.2 Materials

Components	Material
Housing	PBT
Display window, light guide	PMMA
Buttons, cap	TPE
M12 connection	CuZn, nickel-plated

14.5.3 Materials not in contact with the medium

Information according to REACH Regulation (EC) 1907/2006 Art. 33/1:

The device battery contains the SVHC 1.3 propane sulton ; ethylene glycol dimethyl ether (CAS number ¹⁾ 110-71-4) with more than 0.1% (w/w). The product does not present a hazard if it is used as designated.

14.5.4 Impact loads

The product is designed for mechanical impact loads of 1 J (IK06) as per the requirements of EN 61010-1.

14.5.5 Weight

Liquiline Mobile CML18	155 g (5.5 oz)
------------------------	----------------

1) CAS = Chemical Abstracts Service, international identification standard for chemical substances

Index

A

- Accessories 44
- Ambient temperature 47

B

- Battery life 47
- Bluetooth connection 26

C

- Cable specification 47
- Charging the device 13
- Cleaning 43
- Commissioning 25
- Connection
 - Fixed cable sensor 12
 - Measuring cable 13
 - Sensor 12
 - Sensors 47
 - Supply voltage 47

D

- Data logger 30
 - Enable/disable 30
 - Log interval 30
 - Ultrapure water 31
- Date and time
 - Date 26
 - Time 26
- Degree of protection 15, 47
- Device information
 - Device name 26
 - Extended order code 26
 - Manufacturer identification 26
 - Serial number 26
 - Software version 26
- Dimensions 48
- Display language 26

E

- Electrical connection 12
- Electrical safety 48

F

- Firmware update 40

H

- Hardware reset 29

I

- Impact loads 49
- Incoming acceptance 10
- Input
 - Measured variables 46
- Intended use 6

L

- Language 26

M

- Manufacturer's address 11
- Materials 49
- Measured variables 46
- Measuring parameters 9
- Measuring range 46

N

- Nameplate 10

O

- Operation 32
 - Calibration 32
 - Device operation 16
 - Grab Sample 33
 - LED status indicator 20
 - Operating menu 17
 - Reading measured values 32
 - Saving the sample 33
 - SmartBlue app 20
- Operation options 16
- Order code 10
- Output signal 46
- Overvoltage protection 47

P

- Pollution degree 48
- Power supply 47
 - Overvoltage protection 47
 - Sensor connection 47
 - Supply voltage 47
- Product description 8
- Product design 8

Product identification	10
Product page	10
Product safety	7

R

Relative humidity	47
Requirements for the personnel	6

S

Safety

Operational safety	7
Product	7
Workplace safety	6

Safety instructions	6
-------------------------------	---

Saving the measured value

Data logger	33
-----------------------	----

Scope of delivery	11
-----------------------------	----

Sensor

Connection	47
----------------------	----

Settings	26
--------------------	----

Audio	28
Data logger	30
Display brightness	29
Energy settings	27
Signal sounds	28
Switching units	31

State-of-the-art technology	7
---------------------------------------	---

Storage temperature	47
-------------------------------	----

Supply voltage	47
--------------------------	----

Switching off	40
-------------------------	----

Switching on	25
------------------------	----

Symbols	4, 5
-------------------	------

T

Technical data	46
--------------------------	----

Environment	47
-----------------------	----

Input	46
-----------------	----

Mechanical construction	48
-----------------------------------	----

Output	46
------------------	----

Technical personnel	6
-------------------------------	---

Types of input	46
--------------------------	----

U

Update	40
------------------	----

Use

Intended	6
--------------------	---

W

Warnings	4
--------------------	---

Weight	49
------------------	----

Workplace safety	6
----------------------------	---



71558219

www.addresses.endress.com
