

VK Pro

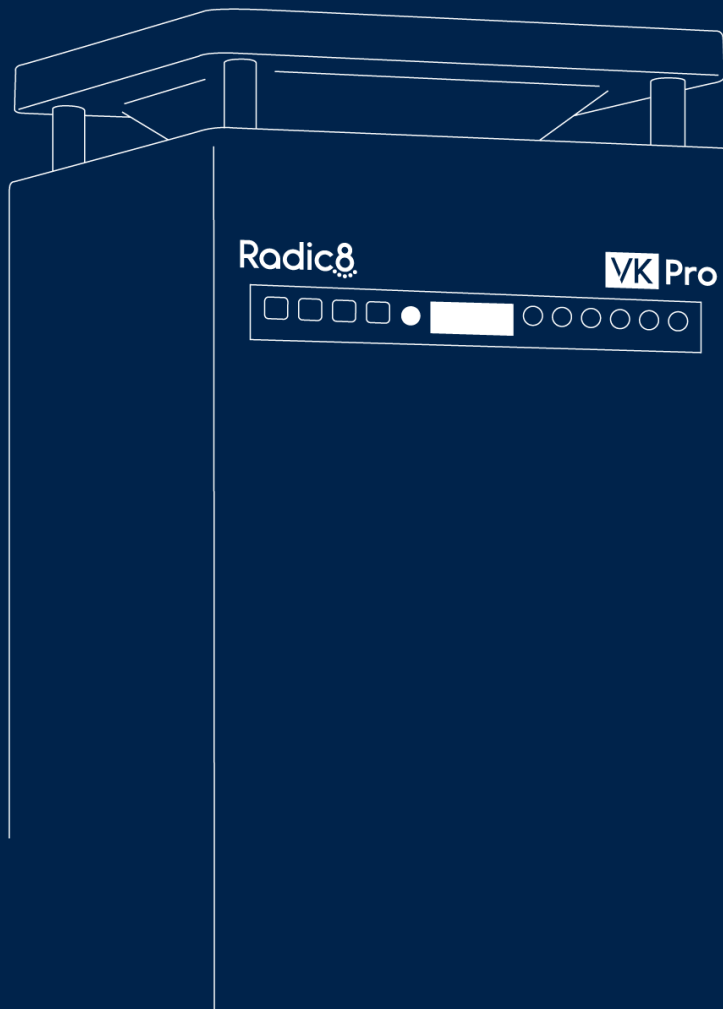

Radic8
www.radic8.com

Table of Contents

- 1. VK Pro 1**
- 2. Safety and Regulation 2**
 - 2.1. Safety Information 3
 - 2.2. Regulatory Information 5
- 3. Warranty 8**
- 4. Product Overview 9**
 - 4.1. Package Contents 10
 - 4.2. VK Pro 11
 - 4.3. Control Panel 12
 - 4.4. Remote Control 14
- 5. Installation 15**
- 6. Operation 19**
- 7. Maintenance 23**
 - 7.1. VK Pro Filters 24
 - 7.2. Changing the Filters 26
 - 7.3. Replacing the Reactor Chamber 37
 - 7.4. Cleaning the Device 38
 - 7.5. Troubleshooting 39
 - 7.5.1. Error Messages 40
- 8. Specifications 41**
- 9. Support 43**

1. VK Pro

User Manual

Version 1.0

Document Number VKP-4-10.3

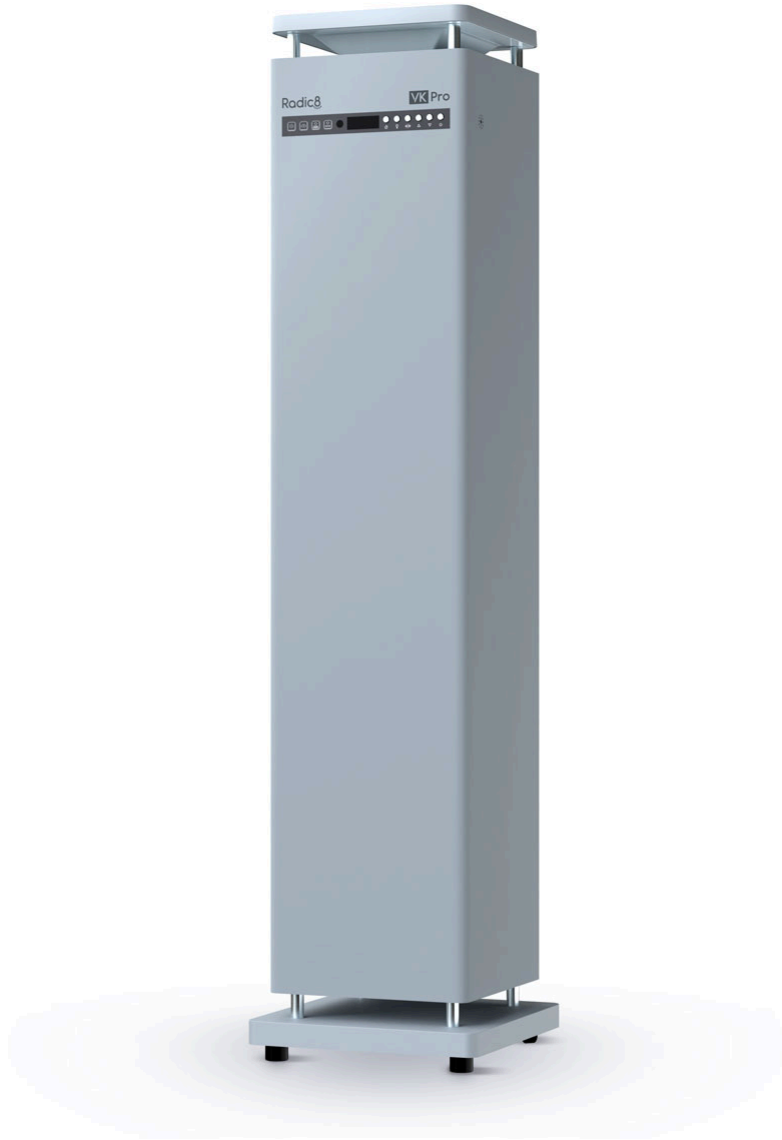

For the latest version of this manual, go to radic8.com/support

2. Safety and Regulation



Radic8 will not be responsible for any injury or loss resulting from the user's failure to operate this device in accordance with its user manual, as updated from time to time, available on www.radic8.com

2.1. Safety Information

 Read and save these user servicing instructions.

Warning

To reduce the risk of fire, electric shock, or injury to persons, please follow the instructions below:

- Use this device only in the manner intended by the manufacturer.
- No modification of this device is allowed.
- This device is not intended for use by persons (including children) with reduced physical, sensory, or mental capabilities or lack of experience and knowledge, unless they have been given supervision or instruction concerning use of the device by a person responsible for their safety.
- Children shall not play with the appliance. Cleaning and user maintenance shall not be made by children without supervision.
- Before use, ensure correct mains AC voltage.
- Do not operate the device with a damaged power cord or plug.
- Do not attempt to alter or modify the power cord or plug.
- Do not run cord under carpeting. Do not cover cord with throw rugs, runners, or similar coverings. Do not route cord under furniture or appliances. Arrange cord away from trafficked areas to ensure it will not be tripped over.
- Do not position the device in a way that makes it difficult to disconnect the plug from the wall socket.
- Prior to cleaning or other maintenance, the appliance must be switched off and disconnected from the supply mains.
- Wear personal protective equipment (PPE) such as a disposable face mask and gloves when handling serviceable parts.
- Do not obstruct the device's airflow intakes or outlets.
- Remove batteries from the remote control if not in use for an extended period.
- For products containing batteries, ensure the user does not make contact with the battery case and patient simultaneously.
- Do not use the fan in this device with any solid-state speed control device.
- This device contains a UV-C emitter. Do not stare at the light source.
 - Unintended use of the device or damage to the housing may result in the escape of dangerous UV-C radiation. UV-C radiation may, even in small doses, cause harm to the eyes and skin.
 - Devices that are obviously damaged must not be operated.
 - Do not attempt to replace the UV-C emitter. This must be performed by a trained technician. Please contact your local Radic8 distributor to perform maintenance.
- Skin or eye damage may result from directly viewing the light produced by the lamp in this apparatus. Always disconnect power before servicing.
- Do not immerse any part of the device in liquid or allow liquid or spray aerosols to enter the device.
- In the event of smoke, unusual odors, or strange noises, switch off the device immediately and disconnect from power. Contact your local Radic8 distributor for support.

- Dispose of device in accordance with local regulations.
- Use biocides safely and sustainably. It is illegal to use this product in a manner other than prescribed on this label.
- **EU ONLY:** This appliance can be used by children aged 8 years and over, as well as persons with reduced physical, sensory, or mental capabilities, or lack of experience and knowledge, provided they have been given supervision or instruction concerning use of the appliance in a safe way and understand the hazards involved.

Please refer to the [Maintenance](#) section of this manual for details concerning the method, frequency of cleaning, and necessary precautions to be taken during maintenance of this device.

2.2. Regulatory Information

Use Environment

The VK Pro should be used indoors and must not be placed outdoors or anywhere that it will be exposed to water, rain, or the elements.







User Proficiency

The VK Pro does not require any specific skills to operate. Follow the simple instructions when required to replace the filters and contact a Radic8-approved distributor when the Reactor Chamber requires replacing. The Reactor Chamber must be replaced by a Radic8-approved technician only.

Principle method:





Mechanical air filtration and UV sterilization. This device is equipped with a UV lamp and does not employ ionizers or other ozone-generating components.

Labelling Symbols





	Follow instructions for use
	Manufacturer identification
	Date of manufacture
	Catalog number
	Serial number
	Waste electrical and electronic equipment (WEEE). It is the responsibility of the end user to dispose of this equipment at a designated collection point.
	Restriction of Hazardous Substances. The RoHS directive restricts the use of ten hazardous materials in the manufacture of various types of electronic and electrical equipment.

	<p>Ingress Protection or International (or Internal) Protection. IP20 indicates protection of this device against intrusion of solid objects larger than 12mm (accidental finger contact).</p>
---	--

Transport and Storage Symbols

	<p>Indicates correct upright position of the transport package.</p>
	<p>Indicates that the transport package shall be kept away from rain and in dry conditions.</p>
	<p>Indicates that the contents of the transport package are fragile and that the package shall be handled with care.</p>
	<p>Indicates that the package shall be handled with care.</p>

Certification

	<p>European Conformity indicates that a product has been assessed by the manufacturer and deemed to meet European Union (EU) safety, health, and environmental protection requirements. This certification is required for products manufactured anywhere in the world that are marketed in the EU.</p>
	<p>The Federal Communications Commission certification indicates that the device meets regulated limits for ionizing radiation and is employed on electronic products manufactured or sold in the United States. This indicates that the electromagnetic radiation from the device is below the limits specified by the Federal Communications Commission and the manufacturer has followed the requirements of the Supplier's Declaration of Conformity authorization procedures.</p>
	<p>UL Listing means that UL has tested representative samples of a product and determined that the product meets specific, defined requirements. These requirements are based on UL's published and nationally recognized standards for safety.</p>
	<p>The UKCA (UK Conformity Assessed) indicates that a product has been assessed by the manufacturer and deemed to meet the UK safety, health, and environmental protection requirements. This certification is required for products manufactured anywhere in the world that are marketed in the UK.</p>
	<p>BSMI certification is mandatory for electrical and electronic products under the Commodity Inspection Act and applicable to certain products that are marketed in Taiwan.</p>

FCC Notice

This device complies with part 15 of the FCC Rules. Operation is subject to the following two conditions: (1) This device may not cause harmful interference, and (2) this device must accept any interference received, including interference that may cause undesired operation.

As far as possible this device should not be used in the immediate vicinity of other electrical equipment. Normal operation of all electrical equipment in the same vicinity should be observed and verified that normal functionality is being maintained.

NOTE: This equipment has been tested and found to comply with the limits for a Class B digital device, pursuant to part 15 of the FCC Rules. These limits are designed to provide reasonable protection against harmful interference in a residential installation. This equipment generates, uses, and can radiate radio frequency energy and, if not installed and used in accordance with the instructions, may cause harmful interference to radio communications. However, there is no guarantee that interference will not occur in a particular installation. If this equipment does cause harmful interference to radio or television reception, which can be determined by turning the equipment off and on, the user is encouraged to try to correct the interference by one or more of the following measures:

- Reorient or relocate the receiving antenna.
- Increase the separation between the equipment and receiver.
- Connect the equipment into an outlet on a circuit different from that to which the receiver is connected.
- Consult the dealer or an experienced radio/TV technician for help.

Please note that changes or modifications not expressly approved by the party responsible for compliance could void the user's authority to operate the equipment.

Disposal

Dispose of device in accordance with local regulations. Consisting of steel, plastic, and rubber, significant portions of this device are recyclable and should be disposed of in an environmentally friendly manner by a third-party recycling company.

3. Warranty

In the event of a warranty claim, please immediately contact your local Radic8 distributor about your warranty and follow your local Radic8 distributor's instructions. The Radic8 authorized distributor must follow Radic8's warranty policy and warranty claim process.



Please take note of the important conditions forming part of any product warranty that may be in place, including but not limited to the following:

- Immediately turn off and stop using this product as soon as any defect is detected. Failure to do so will exclude any warranty claim.
- Any damage due to external causes will exclude any warranty claim, including without limitation, accident, abuse, misuse, mishandling, negligence, incorrect and/or inconsistent power supply and/or any other electrical power supply reason, water or moisture damage, abnormal storage, abnormal working conditions, and any damage caused by consumables and parts not supplied by Radic8.
- Only Radic8 parts must be used when replacing consumables, maintaining and/or repairing this product, and failure to do so will exclude any warranty claim.
- Only a Radic8-approved technician may perform any required repairs, and failure to do so will exclude any warranty claim.
- Any warranty that may be in place is non-transferable and is only granted to the customer who purchased this product directly from a Radic8 authorized distributor ("Customer").
- It is the Customer's responsibility to ensure that this product is operated and maintained in accordance with the instructions as set out in this product's user manual, as updated from time to time, and failure to do so will exclude any warranty claim.

4. Product Overview

The VK Pro is designed for uncompromising clean air performance in busy environments of all kinds. It is intended to be used for clean air delivery in large, communal, or open-plan spaces.

4.1. Package Contents

	VK Pro		User manual
	IEC power cable (plug type based on region)		Remote control (batteries not included)

4.2. VK Pro



1	Tower light	Signals device is operational
2	Control panel	Displays device information and provides input
3	Indoor Air Quality (IAQ) sensor	Detects VOC and PM levels in Auto mode
4	AC input	Power input from the included C13 mains plug
5	Back filter tray	Houses back pre-filter, carbon filter, and HEPA filter
6	Bottom filter tray	Houses bottom pre-filter, carbon filter, and HEPA filter

4.3. Control Panel

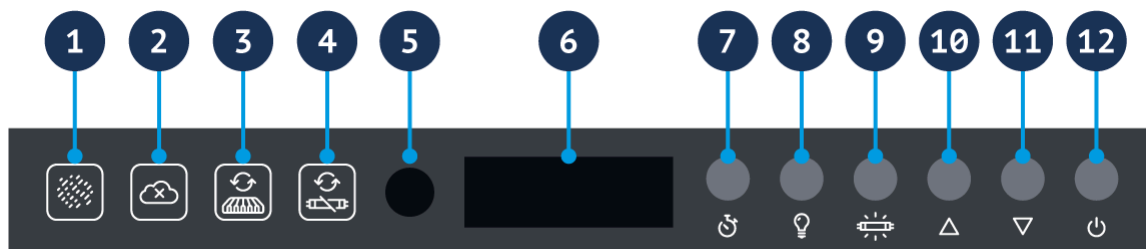

1	PM indicator	Indicates increased levels of particulate matter (PM)
2	VOC indicator	Indicates increased levels of volatile organic compounds (VOCs)
3	Filter replacement indicator	Indicates when the filters must be replaced
4	Reactor Chamber replacement indicator	Indicates when the Reactor Chamber must be replaced by a Radic8-approved technician
5	IR sensor	Accepts input from the included remote control
6	LCD display	Displays operational and device information
7	Timer	Cycles through timer modes of 3, 6, or 9 hours
8	Lamp button	Switches the tower light on or off
9	UV-C button	Switches the internal UV-C Reactor Chamber on or off
10	Up button	Increases the fan speed

11	Down button	Decreases the fan speed
12	Power button	Switches the device on or off

4.4. Remote Control

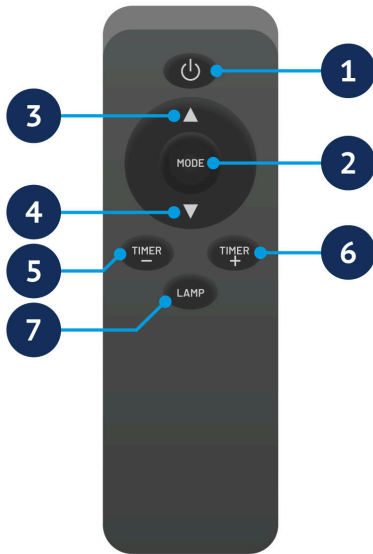

1	Power button	Switches the device on or off
2	Mode button	Displays and cycles through device information on the LCD display
3	Up button	Increases the fan speed
4	Down button	Decreases the fan speed
5	Timer (-) button	Cycles down through timer modes of 3, 6, or 9 hours
6	Timer (+) button	Cycles up through timer modes of 3, 6, or 9 hours
7	Lamp button	Switches the tower light on or off

5. Installation

- ! Before installation, ensure you have read this manual and understand the operational requirements of the device.

1. Place the device upright in the desired location.

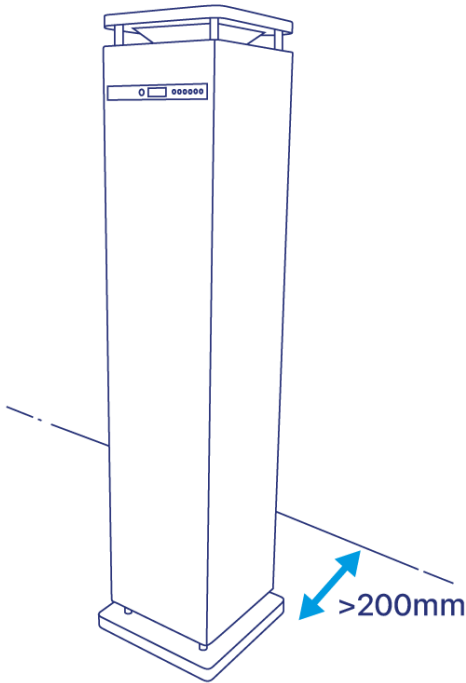

Placement guidance:

- Ensure the air intake and outlet are not obstructed.
- The VK Pro should be placed centrally for maximum benefit.
- Ensure the VK Pro is placed at least 200mm (8") from a wall.

2. Prepare the remote control:

A) While pressing the release latch on the back of the remote control, remove the battery compartment cover.

B) Insert two AAA batteries (not included) into the battery compartment. Ensure the negative terminals (marked by '-' symbols) on the batteries make contact with the springs in the battery compartment.

C) Replace the battery compartment cover.

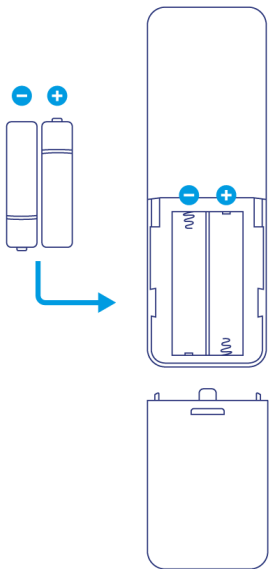

! Remove batteries from the remote control if not in use for an extended period.

3. Retrieve the power cable from the bottom of the device.

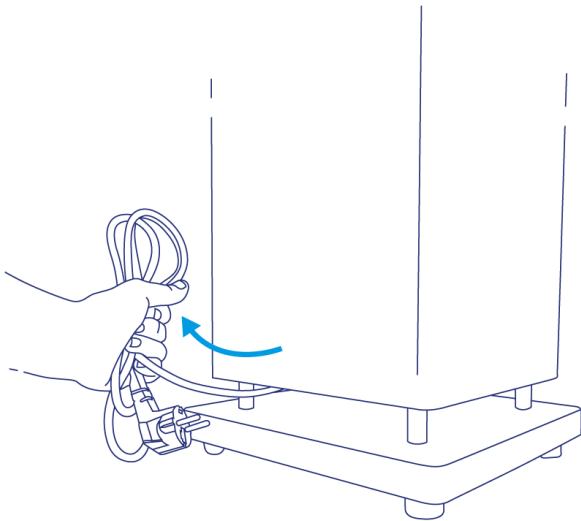

4. Ensure the power plug is securely seated in the AC input.

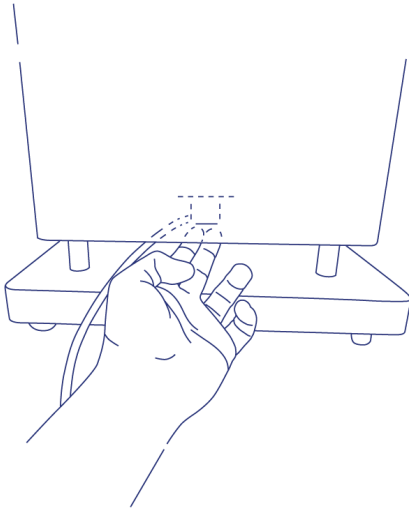

5. Insert power plug into wall socket, ensuring correct mains voltage.

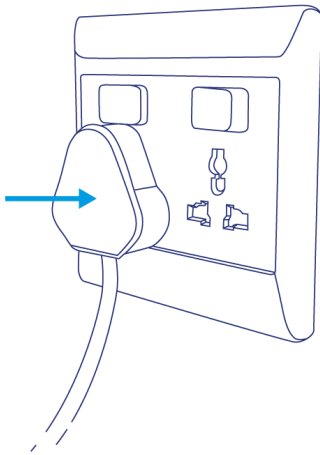

6. The device will automatically power on in [Auto mode](#).

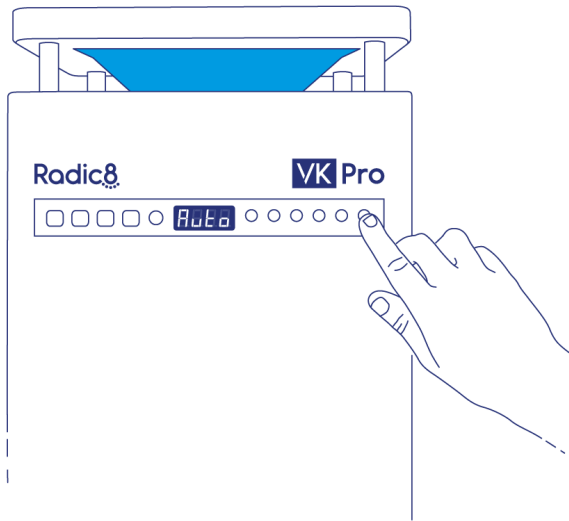

6. Operation

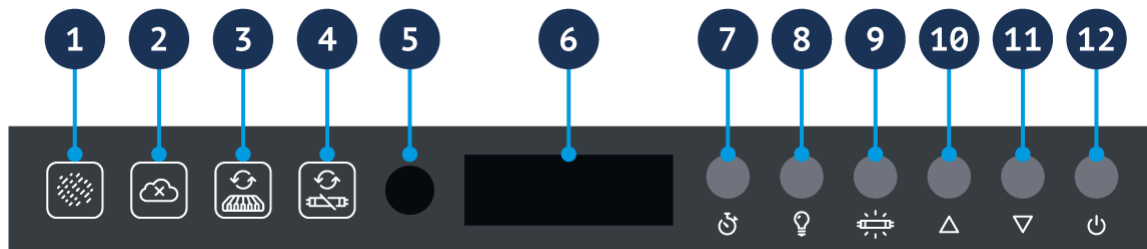

Turn the device on or off



During installation, the VK Pro automatically powers on in Auto mode. Turn the device off or back on again by pressing the power button (1) on the control panel or on the remote control.

✿ If the device remains unused for a long period of time, remove the power cord, unplug the mains plug from the wall socket, and store the device away safely.

LCD display

LCD display	Text	Fan mode	Description
	AUTO	Auto	The device is in Auto mode
	FAN 1	Manual	Low fan speed
	FAN 2	Manual	Medium fan speed
	FAN 3	Manual	High fan speed
	FAN 4	Manual	Highest fan speed
	-001	–	Reactor Chamber replacement warning
	FILT	–	Filter replacement warning







Auto and Manual Modes







Move between Auto and Manual modes by pressing the Up () or Down () buttons on the control panel or remote control.

Auto Mode

Auto mode is indicated by 'AUTO' shown on the LCD display.

In Auto mode, the VK Pro detects the quality of the air with a built-in indoor air quality (IAQ) sensor that monitors levels of volatile organic compounds (VOCs) and particulate matter (PM), and automatically sets the fan speed:



- When low levels of PM or VOCs are present, the PM () or VOC () lights on the control panel will remain white. The fan will run at low speed for quieter operation.
- When moderate levels of PM or VOCs are detected, the PM () or VOC () lights on the control panel will turn yellow. The fan speed will automatically increase for greater airflow and rapid filtration.
- When high levels of PM or VOCs are detected, the PM () or VOC () lights on the control panel will turn red. The fan speed will increase significantly to help quickly reduce the presence of these airborne pollutants.

	PM	VOCs	Fan speed in AUTO mode
Normal / low levels detected			Low
Moderate levels detected			Medium
High levels detected			High

Manual Mode

Manual mode is indicated by 'FAN1-4' shown on the LCD display.

Adjusting the fan speed

In Manual mode, the VK Pro's fan runs at a constant speed, as set by the user. Press the Up () or Down () buttons on the control panel or remote control to adjust the fan speed.

In Manual mode, the fan will not automatically adjust based on the built-in IAQ sensor.

Viewing device information

Press the Mode button (2) on the [remote control](#) once to display the Reactor Chamber runtime (hours). After a few seconds, the current fan speed will display.

Press the Mode button (2) on the [remote control](#) twice to display the particulate matter sensor count ($\mu\text{g}/\text{m}^3$). After a few seconds, the fan speed will display.

Lock the control panel (child lock)

Hold the Power button (1) on the control panel for five seconds to lock the control panel.





While the control panel is locked, the control panel buttons will be inactive. However, the remote control can still be used to change the device settings.

To unlock the buttons, hold the Power button on the control panel for another five seconds.

Set the timer

The VK Pro has a timer that can be set for three, six, or nine hours, after which time the device will power off.

Select a timer setting by pressing the Timer – (5) or Timer + button (6) on the remote control or by pressing the Timer button on the control panel (7). The display will show the following to indicate which timer setting has been selected:

	No timer/ cancel timer	Device will continue to operate
	Sets timer for 3 hours	Device will switch off after 3 hours
	Sets timer for 6 hours	Device will switch off after 6 hours
	Sets timer for 9 hours	Device will switch off after 9 hours

Deactivate the tower light

Press the Lamp button () on the remote control or control panel to turn the tower light on or off.

Deactivate the UV-C Reactor Chamber

Press the UV-C button () on the control panel to turn the Reactor Chamber on or off. The UV-C text below the UV-C button will go dark to indicate the Reactor Chamber is off and illuminate when the Reactor Chamber is switched on.

When the Reactor Chamber is switched off, the device will continue to filter the air but will not expose the air to UV-C or PCO active decontamination.

7. Maintenance

! Always wear personal protective equipment (PPE) such as a disposable face mask and gloves when replacing the filter(s) on your device.

! Before handling the device to perform maintenance, lightly mist the body with an 85% alcohol-based (or equivalent) sanitizer.

Maintenance of your VK Pro and replacement of consumables is essential to ensure the longevity of the device.

Ensure the device is switched off and disconnected from the mains before conducting any maintenance.

7.1. VK Pro Filters

The VK Pro contains two filter trays:

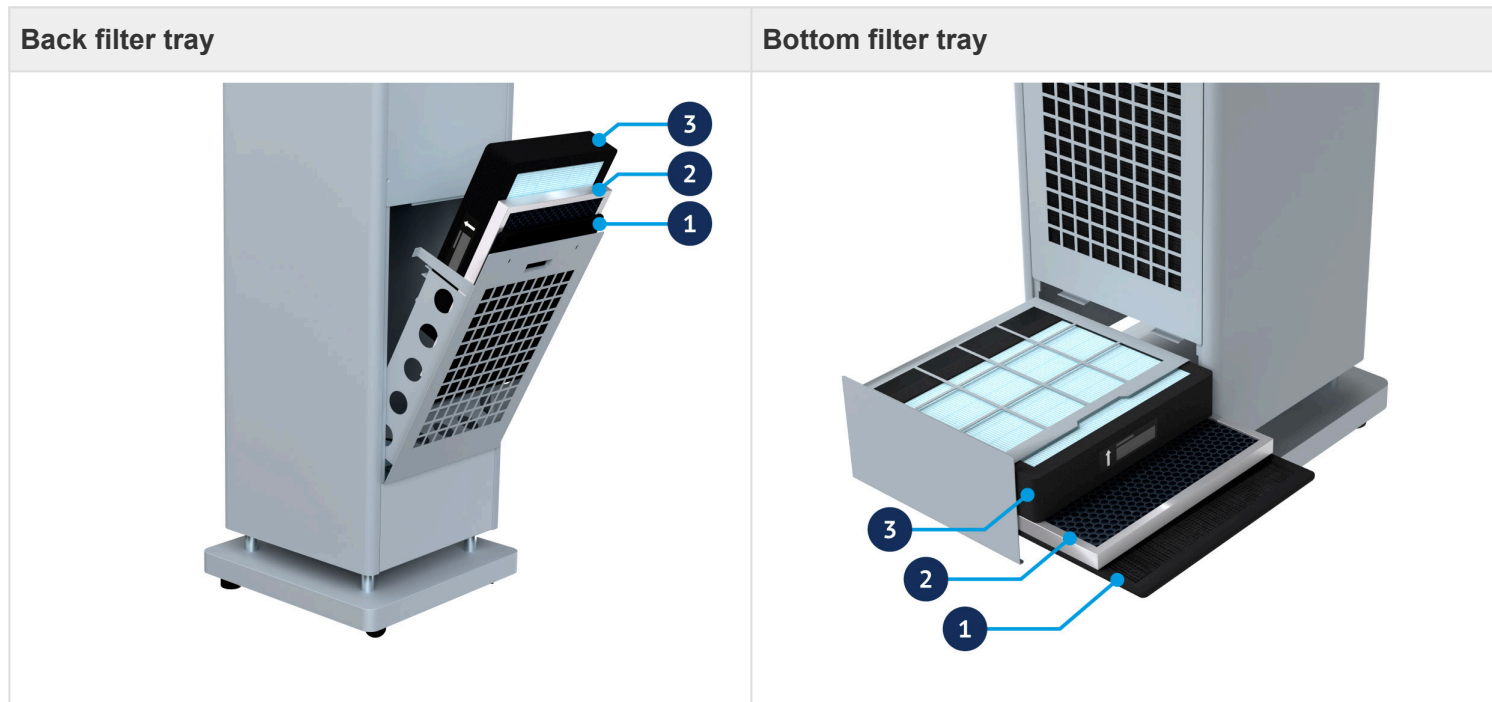

Each filter tray contains three filters:

1	Pre-filter	Reusable. Clean regularly for efficient operation.
2	Carbon filter	Disposable. Replace when the filter replacement indicator illuminates.
3	HEPA filter	Disposable. Replace when the filter replacement indicator illuminates.

The filters should always be arranged in the filter trays with the pre-filter closest to the outside of the device, the carbon filter in the middle, and the HEPA filter towards the inside of the device. In addition, the HEPA filter has an arrow on its label to indicate the airflow direction. The arrow should point towards the inside of the device:

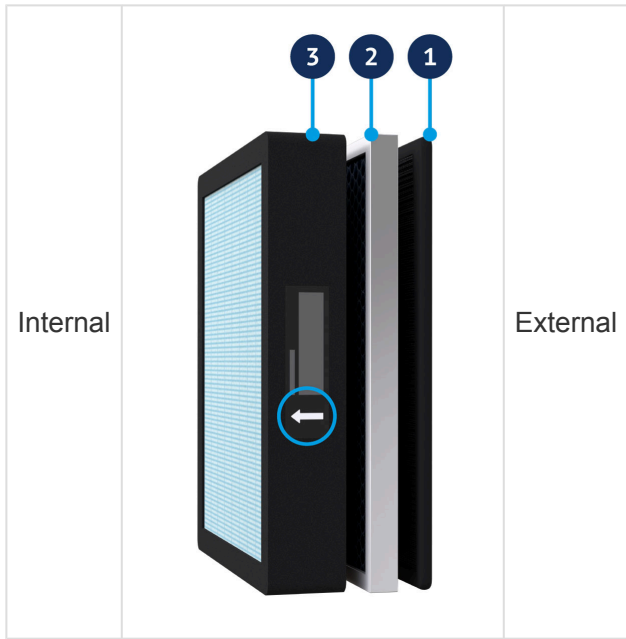

7.2. Changing the Filters

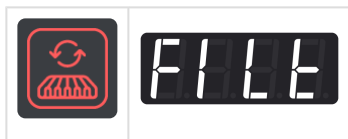

When the carbon and HEPA filters are due to be replaced, the filter replacement indicator on the control panel will turn red and the LCD display will read 'FILT'.

Please contact your local Radic8 distributor to purchase replacement HEPA and carbon filters.

Changing the back filters

1. Switch off the device and remove the AC plug from the wall socket.
2. Remove the two screws from the back filter tray:

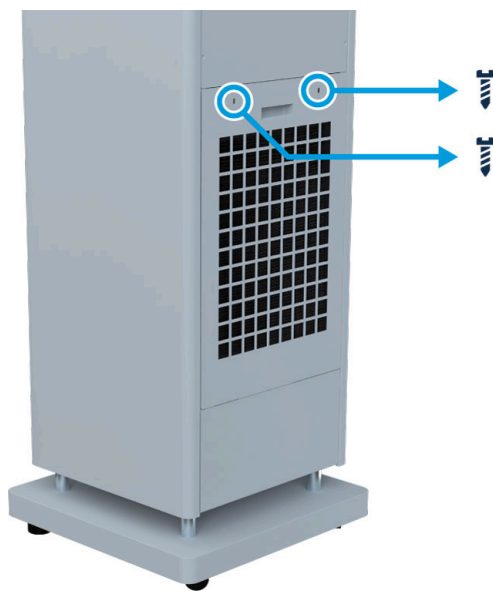

3. Slowly pull and lower the tray out of the device and carefully remove it:

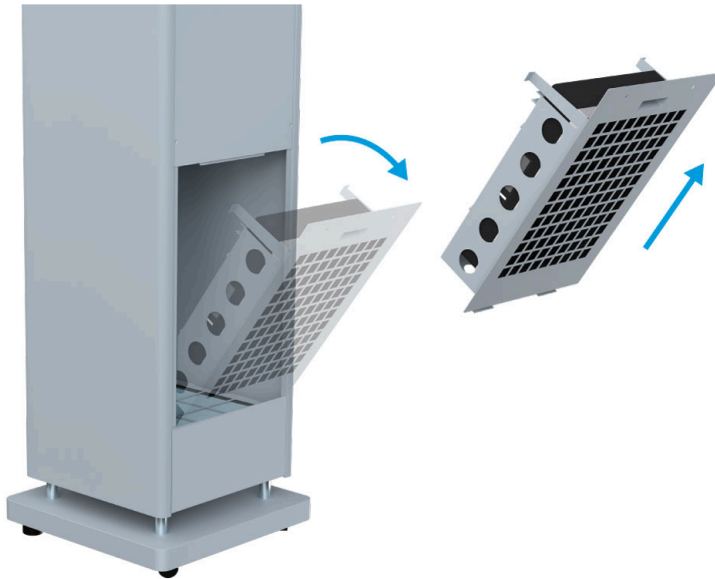

4. Undo the four filter grid screws and slide out the filter grid:

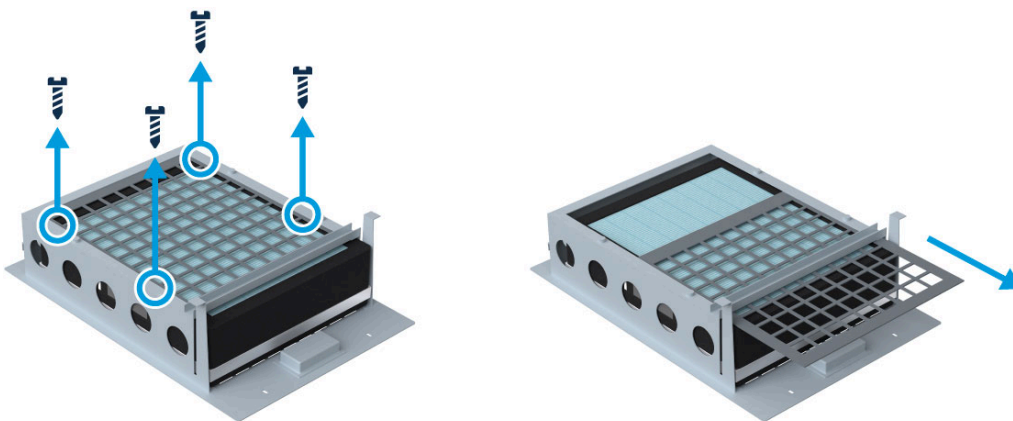

5. Remove the HEPA filter and carbon filter from the filter tray and [safely dispose of them](#):

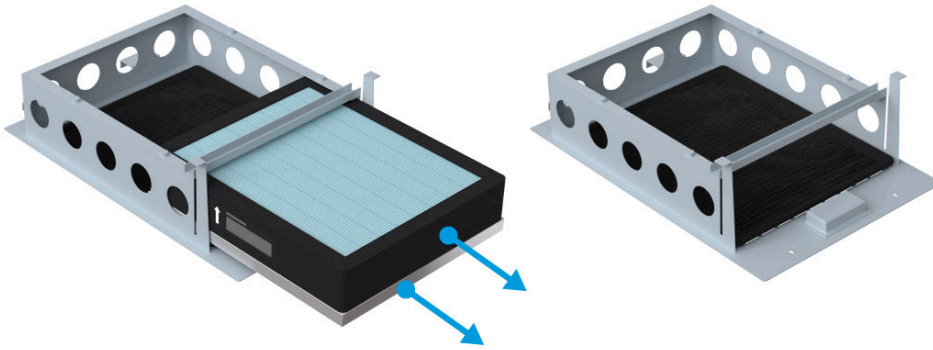

6. Slide out the pre-filter and [clean it](#) with a damp dust cloth:

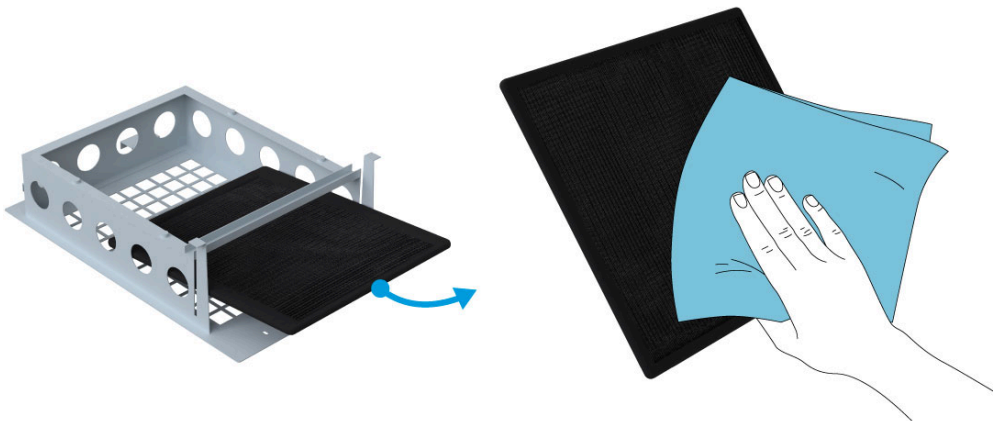

7. Ensure the pre-filter is completely dry and reinsert it into the filter tray towards the external side of the tray. Insert a new carbon filter in the middle of the filter tray:

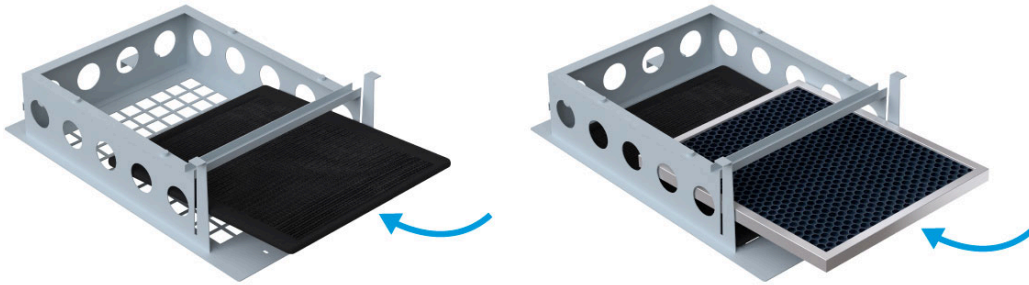

8. Insert a new HEPA filter into the filter tray towards the internal side of the tray. Ensure the arrow on the HEPA filter label points towards the inside of the device:

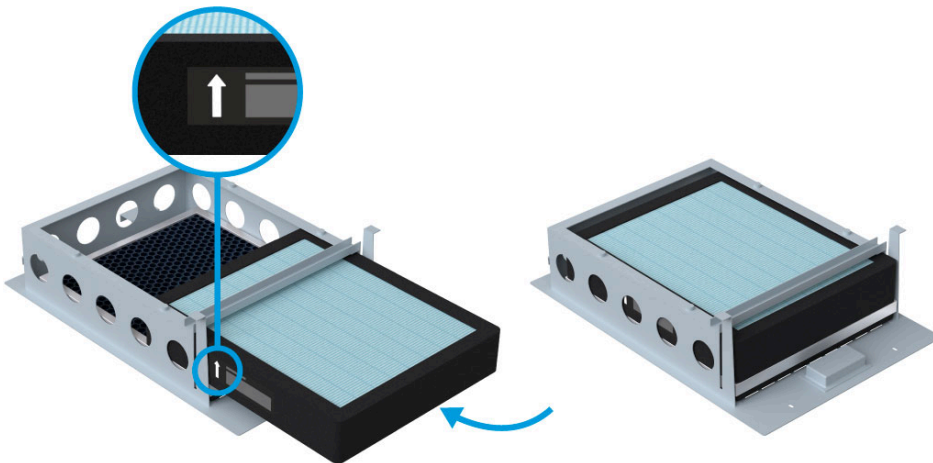

9. Reinsert the filter grid and secure with the four filter grid screws:

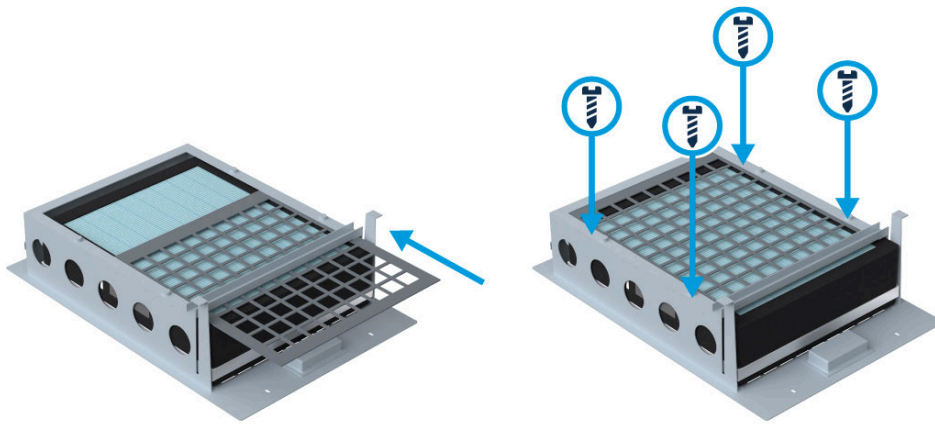

10. Reinsert the back filter tray into the device and push it back into place:

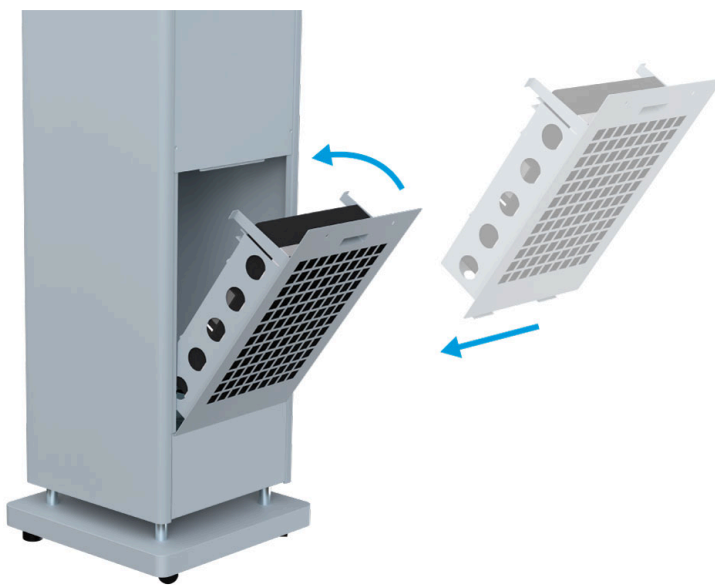

11. Secure the back filter tray with the two screws:

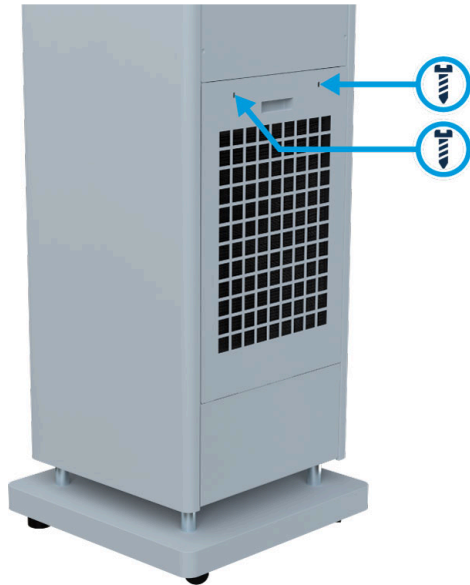

Changing the bottom filters

1. Switch off the device and remove the AC plug from the wall socket.
2. Remove the two screws from the bottom filter tray:

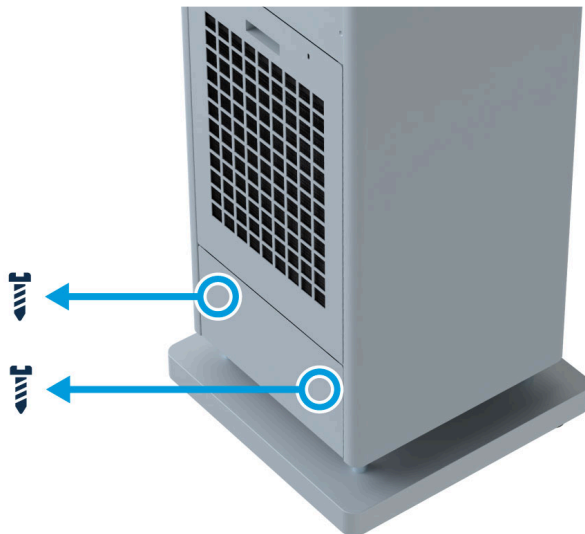

3. Grip the filter tray and pull it down towards the floor, then pull it outwards:

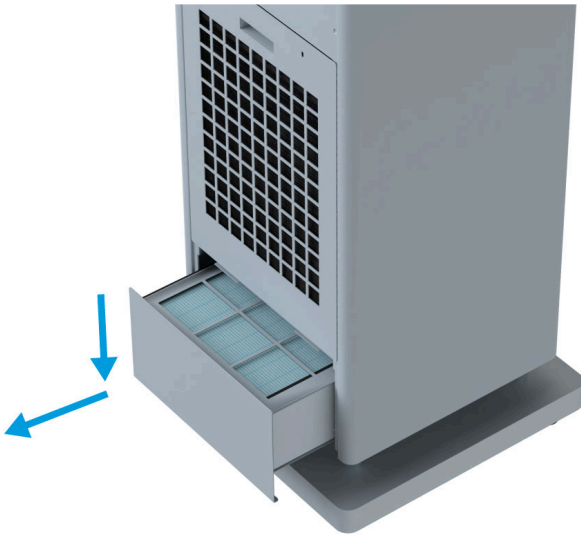

4. Undo the four filter grid screws and slide out the filter grid:

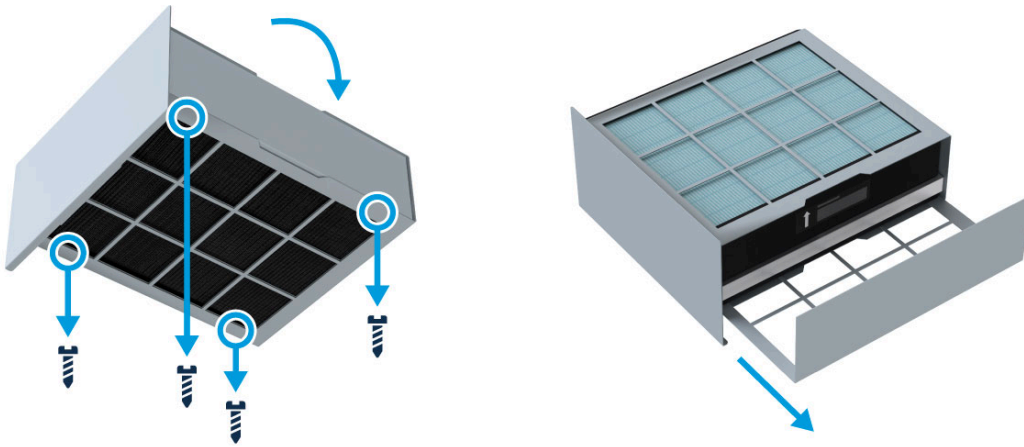

5. Remove the HEPA filter and carbon filter from the filter tray and [safely dispose of them](#):

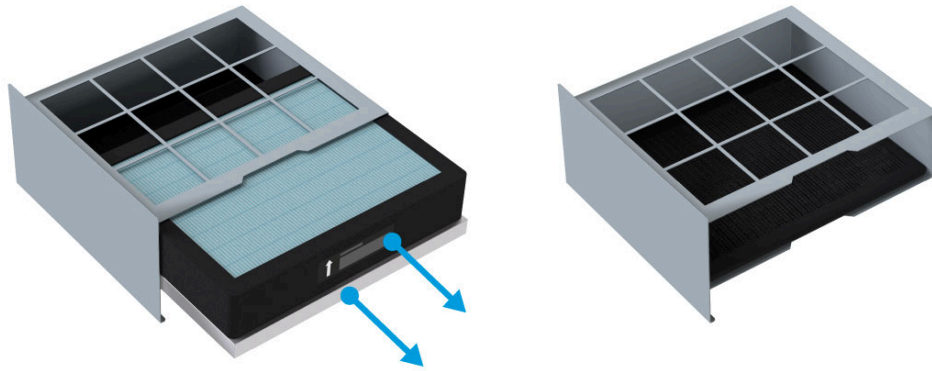

6. Slide out the pre-filter and [clean it](#) with a damp dust cloth:

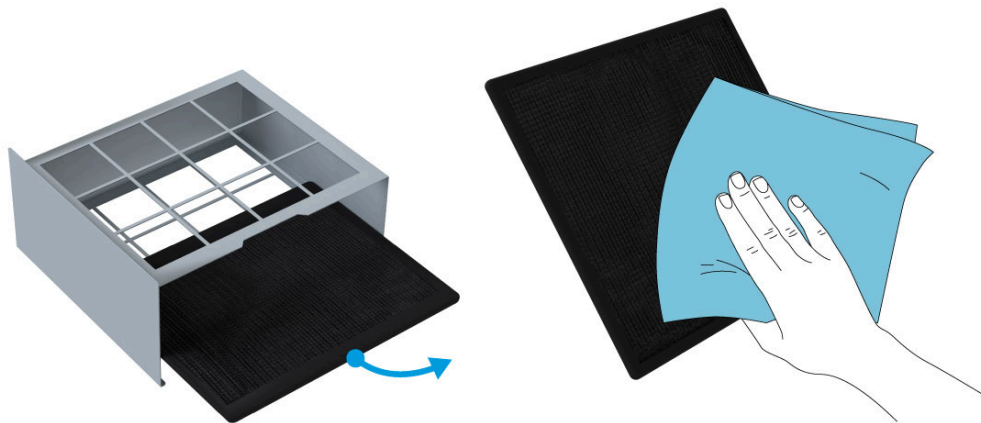

7. Ensure the pre-filter is completely dry and reinsert it into the bottom of the filter tray. Insert a new carbon filter in the middle of the filter tray:

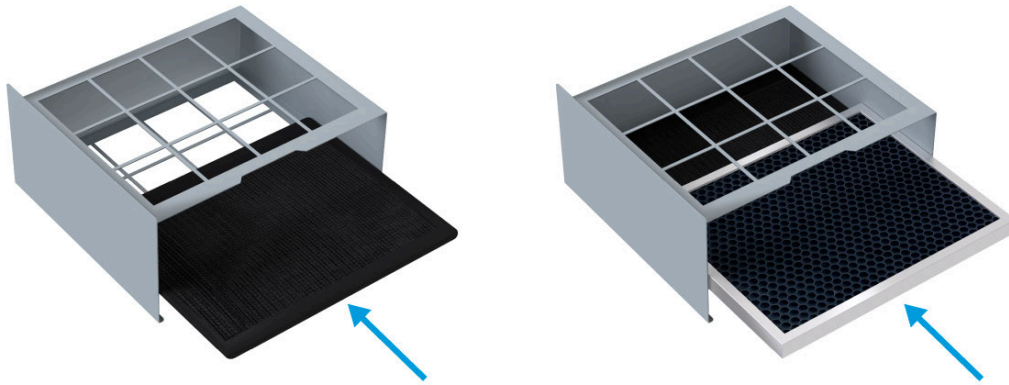

8. Insert a new HEPA filter into the top of the filter tray. Ensure the arrow on the HEPA filter label points towards the inside of the device (upwards):

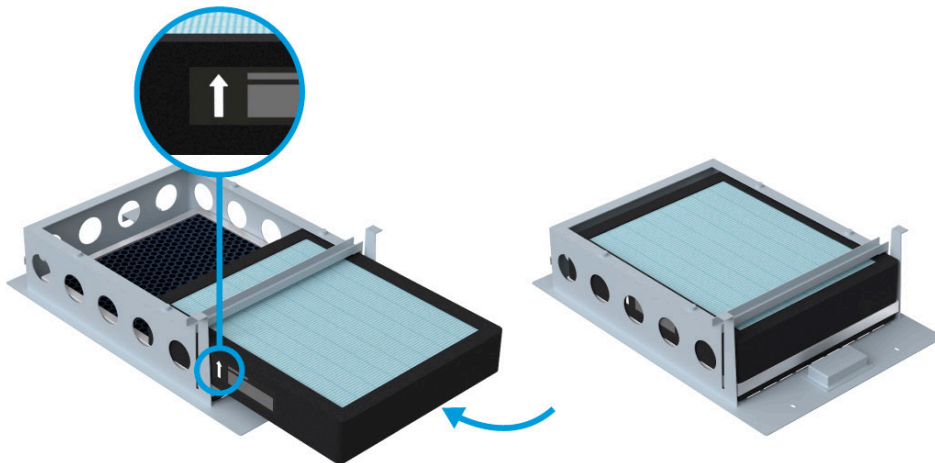

9. Reinsert the filter grid and secure with the four filter grid screws:

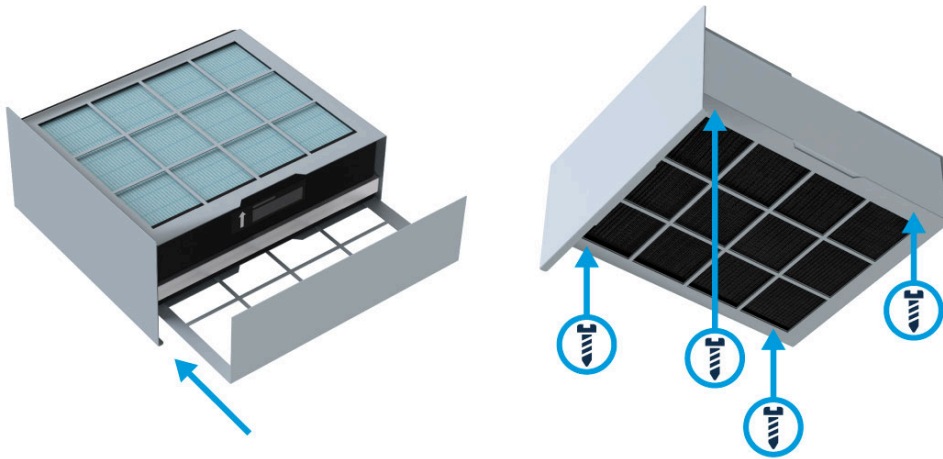

10. Slide the filter tray back into the device:

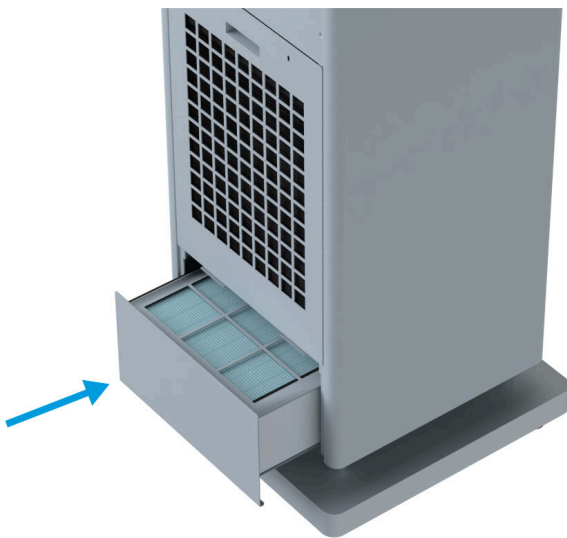

11. Secure the back filter tray with the two screws:

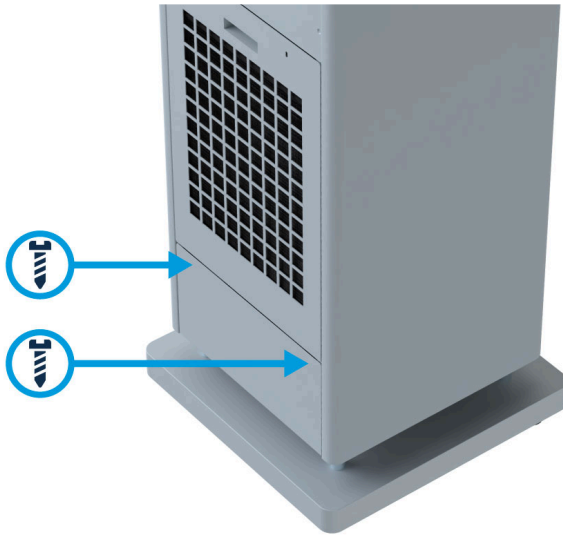

Disposing of filters

After the used filter has been removed, lightly mist the filter material with an 85% alcohol-based sanitizer, place it in a tied or sealed plastic bag, and safely dispose of it.

Resetting the filter warning

Once both filter trays are securely replaced, turn the device on and hold the [Up button on the control panel](#) for five seconds to reset the filter timer.

Cleaning the pre-filter

The pre-filters in the back and bottom filter trays can be cleaned and reused. Radic8 recommends cleaning the pre-filters regularly for optimal performance, depending on the environment in which the device operates.

Clean the pre-filter with a damp dust cloth, ensuring the filter is completely dry before [returning to the filter tray](#).

7.3. Replacing the Reactor Chamber

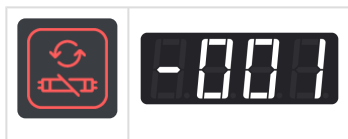

When the Reactor Chamber replacement indicator on the control panel turns red and the LCD display shows '-001', the internal Reactor Chamber must be replaced.

! The Reactor Chamber must be replaced after 8,000 hours of use by a Radic8-approved technician only.

Please contact your local Radic8 distributor or a Radic8-approved technician to have the Reactor Chamber replaced. Radic8 will provide the necessary servicing information and guidance as requested by the approved technician.

7.4. Cleaning the Device

Turn off the device. Switch off the power at the wall socket and remove the plug from the mains supply.

Every week, or when the device is dirty, use a damp dust cloth to wipe down the body of the device to remove excess dust. If using a cleaning product, spray the product directly onto the cloth before wiping the device. Radic8 recommends using an 85% alcohol-based sanitizer for cleaning the body of the device.







 The device and its internals must not be exposed to excess moisture. Ensure the device is completely dry before being powered back on.

7.5. Troubleshooting

Problem	Solution
The device will not switch on	<ul style="list-style-type: none">• Ensure the power cable is firmly seated in the device AC input and the wall socket.
The device switches itself off	<ul style="list-style-type: none">• Ensure that the Timer function has not been activated.• Ensure the power cable is firmly seated in the device AC input and the wall socket.
Minimal airflow	<ul style="list-style-type: none">• The pre-filter may need to be cleaned and the HEPA filter replaced.• Ensure the device's airflow intake or outlet are not obstructed.• Consider increasing the fan speed.
The timer preset does not work	<ul style="list-style-type: none">• Ensure the Timer function has been correctly set for 3, 6, or 9 hours.
Unusual odor emitted from device	<ul style="list-style-type: none">• The pre-filter may be slightly damp. After cleaning, ensure the pre-filter is completely dry before returning to the filter tray.• The carbon filters may need to be replaced.

7.5.1. Error Messages

! In the event of any of the below error messages, turn off the device, switch off the power at the wall socket, and contact your local Radic8 distributor for assistance.

LCD display	Text	Description
	Er – 0	Main PCB overheat error. The device will power off.
	Er – 1	Reactor Chamber not plugged in. The device will power off.
	Er – 2	Fan operation error. The device will power off.
	Er – 3	Micro switch error. The device will power off.
	Er – 4	Input PCB error. The device will not power on.
	Er – 5	Device memory error. The device will not power on.

8. Specifications

 Specifications and design of the VK Pro are subject to change without notice.

Operating Specifications

Firmware Version: v0.3

Fuse: 5A

 Ensure correct mains voltage before use.

110–120V Device

Voltage:	AC 110–120V, 50–60 Hz
Current:	2.2A

220–240V Device

Voltage:	AC 220–240V, 50–60 Hz
Current:	1.1A

Technical Specifications

Model:	VK Pro
Description:	Air Purifier
Mode of operation:	Continuous
Weight:	34.8kg (76.72lbs)
Dimensions (mm):	1570 (H) x 320 (W) x 320 (D)
Dimensions (in):	61.8 (H) x 12.6 (W) x 12.6 (D)
Coverage (1 ACH): *	280m ²
Coverage (2 ACH): *	140m ²
Airflow (CFM):	50–400

Noise (dBA):	30–57 **
Typical Power:	220W ***
IAQ Sensor:	Particulate matter (PM) and volatile organic compounds (VOC) ****
Reactor Chamber lifespan:	8,000 Hours
HEPA filter lifespan:	6 months (approx. 4,000 hours) *****
Carbon filter lifespan:	6 months (approx. 4,000 hours) *****
Pre-filter:	Reusable
Warranty:	1-Year Manufacturer Warranty
Temperature:	10–45°C (50–113°F)
Relative Humidity:	30–80%
Pressure:	80–106kPa
Installation:	Freestanding

* Air changes per hour based on 2.4m (7.8ft) ceiling height.

** Sound pressure level calculated from sound power level as tested against ISO 3744.

*** Measured at highest fan speed.

**** The built-in VOC sensor calibrates each time the device powers on.

***** Dependent on operating environment.

Firmware versions will be based on serial numbers for each device.

The device cannot be installed in an outside area where it will be subject to water, rain, and the elements.

Operation and Transport Conditions: 10–45°C, below 70% RH, 106 KPa

9. Support

For hardware support, please contact your local Radic8 distributor or a Radic8-approved technician.



Radic8 PTE Ltd
9 Raffles Place
27 – 00 Republic Plaza
Singapore, 048619
info@radic8.com



The model and serial number can be found on the label on the device.