

DIA. 18.0

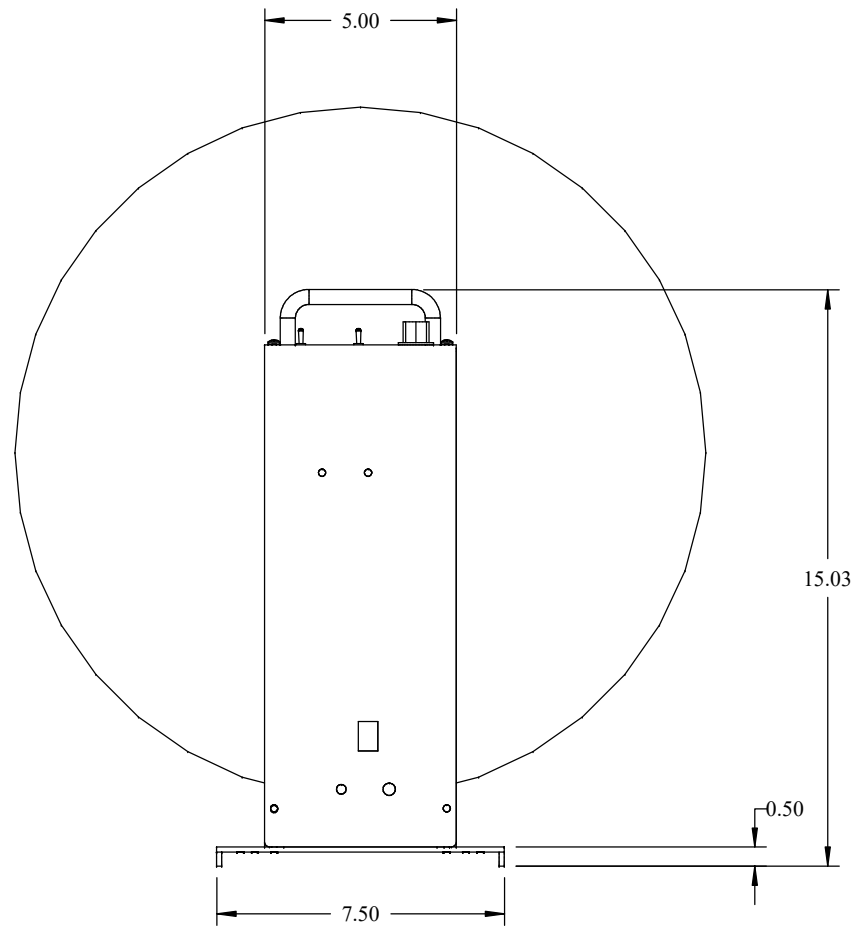
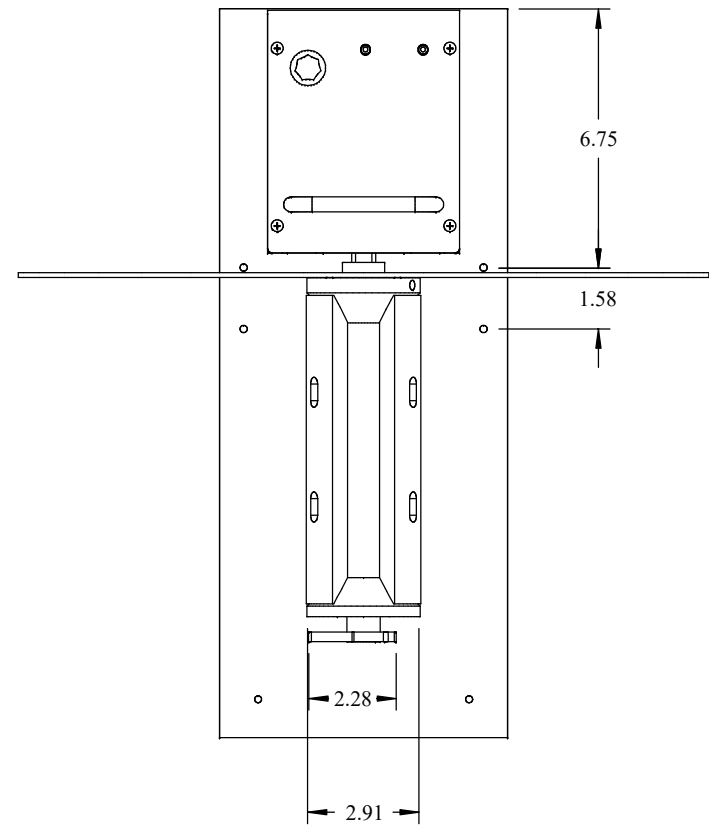
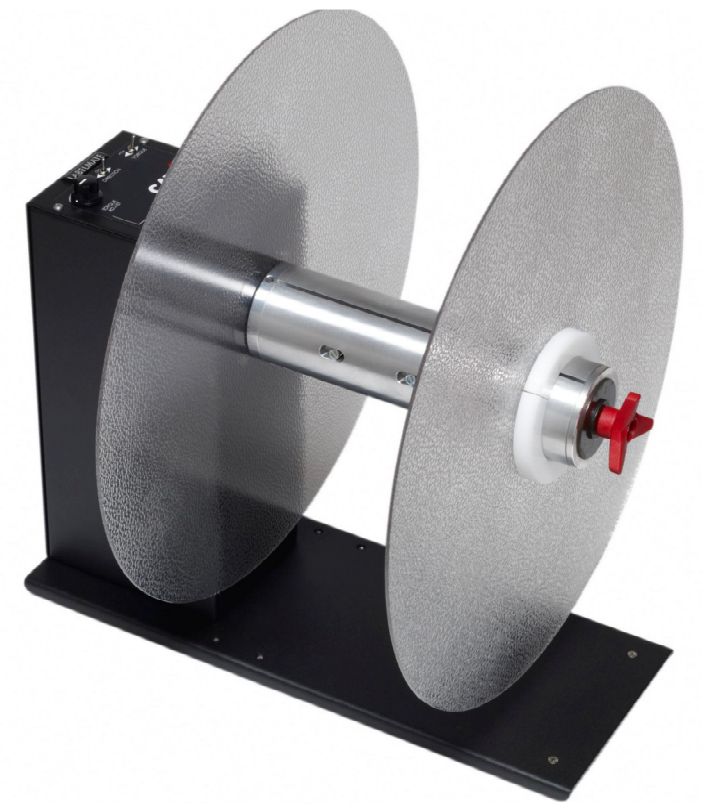
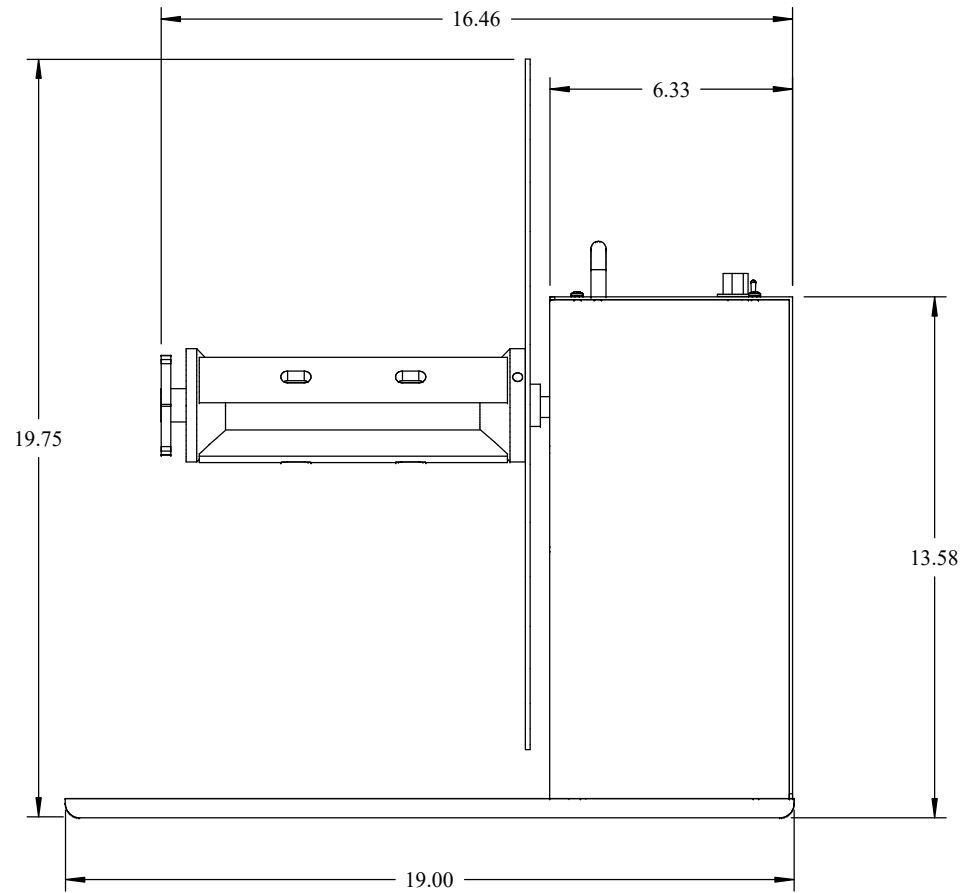
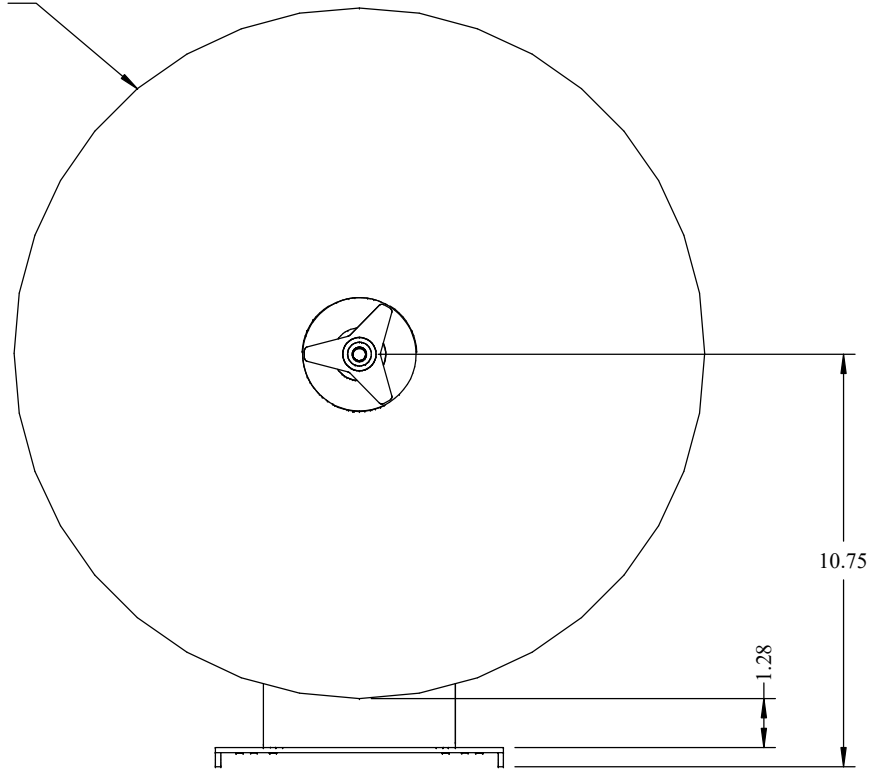

LABELMATE USA 12A Sunset Way, Henderson NV, 89014		
TITLE CAT-3-R18-CHUCK-220		
DATE 7/21/20	PART NO. 80-203-0025	REV A
POWER ADAPTOR PS-65	SHEET 1 OF 1	