

NOTES:

Mechanical Core-Chuck, 3" diameter, 8.6" Length.

- Core Diameter: 3" (76mm)
- Length: 8.6" (220mm)
- Mounting: Setscrew, press fit
- Mounting Hole Diameter: 0.626" (15.9mm)
- Mounting Hole Depth: 1.33" (34mm)
- Composition: Anodized Aluminum
- Warranty: 3 Year Parts and Labor Limited Warranty

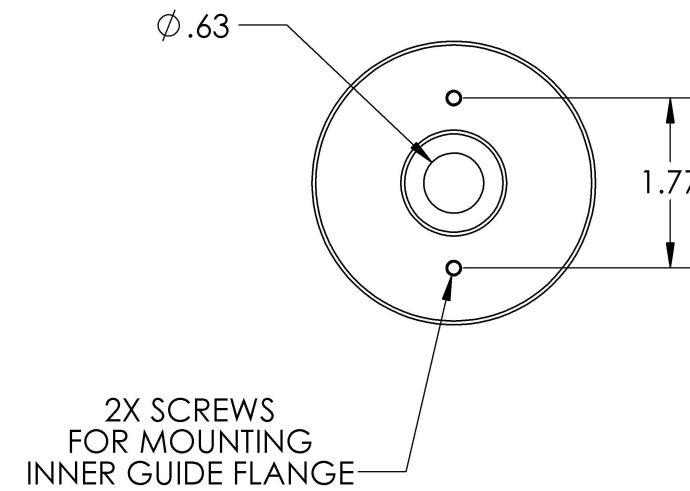
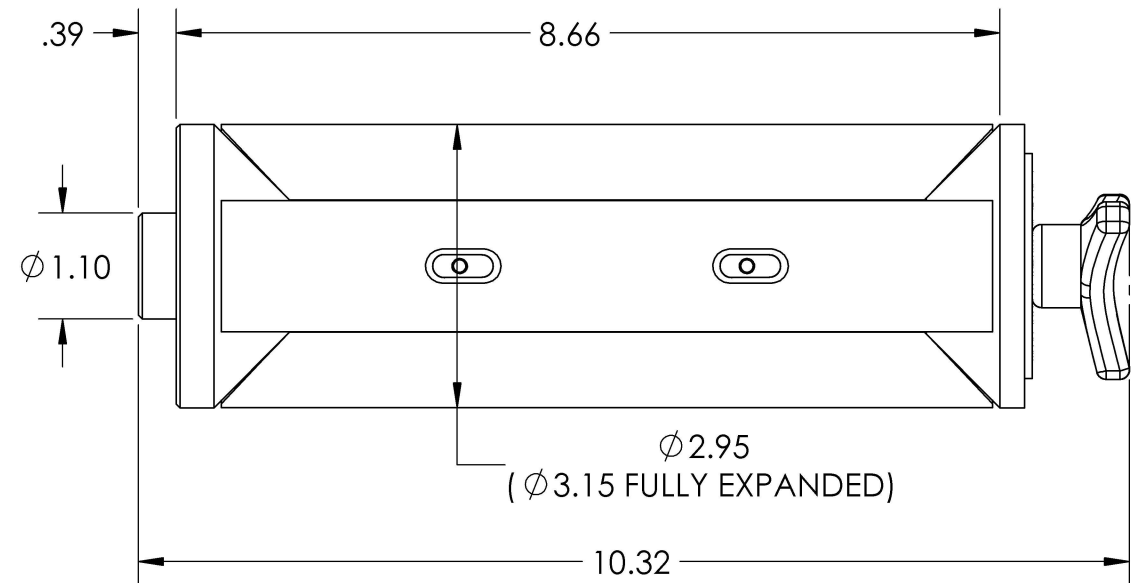
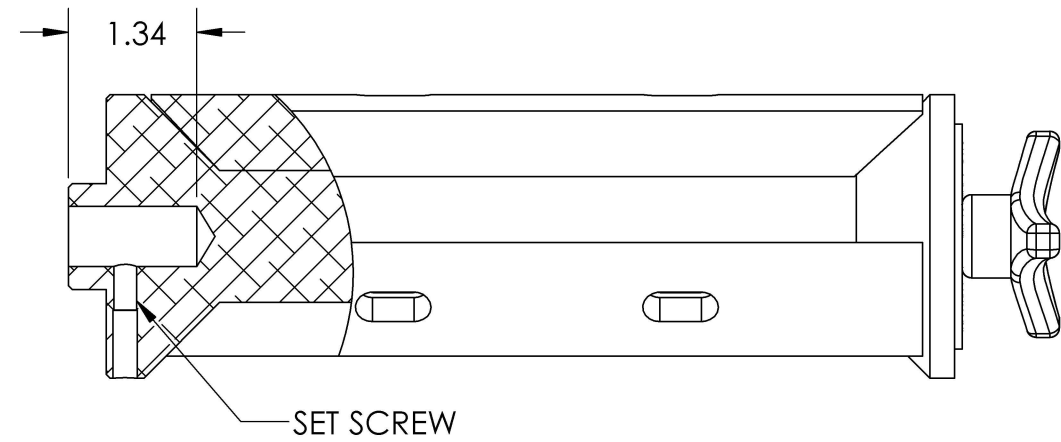

ITEM ID:		
C76-220		
DRAWN BY:	DATE:	PART NO.
TAH	2/1/2023	80-197-0005
POWER SUPPLY:	INPUT:	
PART NO.	OUTPUT:	