

101

C O P E N H A G E N

ARC DINNING TABLE // ASSEMBLY INSTRUCTIONS

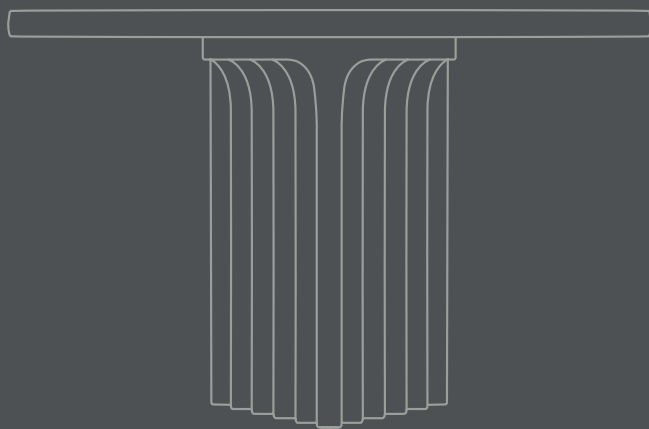



ABOUT 101 COPENHAGEN

101 Copenhagen is a Danish design brand founded in 2017. With a vision to honor exquisite quality and craftsmanship, the collection encompasses furniture, lighting and accessories in a timeless, yet modern design. With a true passion for materials and refined textures, organic shapes and colours, 101 Copenhagen presents the epitome of classics and must-have novelties for Scandinavian and international interior connoisseurs alike.

OUR CREATIVE DRIVE

The design of 101 Copenhagen is firmly rooted in the Scandinavian soil and nourished by Japanese minimalist aesthetics. Sharing an emphasis on quality materials, techniques and traditions, the meeting between the North and the East is notable in the holistic collections of 101 Copenhagen. The design approach is dynamic and characterised by freedom of expression - creating unique and timeless pieces without compromising on playfulness and individuality.

OUR DESIGN TEAM

An attention to detail and a shared sense of aesthetics is what drives the two main designers of 101 Copenhagen, Tommy Hyldahl and Kristian Sofus Hansen. Merging their backgrounds and experiences from the fashion industry, the Royal Danish Academy of Fine Arts and travels in Japan respectively, a narrative of minimalist, sculptural and conceptual design is evident throughout the collections. Translating and transforming the simplistic inspiration from Japan in a Scandinavian context is all about honouring quality, heritage and materiality while never seizing to compromise on form and function. Trained as an architect, the third designer, Nicolaj Noddesbo, adds knowledge on innovative light solutions and timeless novelties to the 101 Copenhagen collections. 101 Copenhagen is a curated selection of tactile, bold objects standing out in a crowd and gathers as a whole.

**CONGRATULATIONS
ON YOUR NEW PRODUCT FROM
101 COPENHAGEN**

101

C O P E N H A G E N

ARC DINING TABLE

As an ode to the Art Deco period, Arc is a transformation of lavish architectural details into a collection of minimalist furniture. Featuring a Console, Bench and Dining Table, the Arc collection is characterized by steps and arches, creating a certain depth and play of shadows. Arc Dining Table goes perfectly together with the Brutus Dining Chairs to create a brutalistic and architectural look. Made from cast fiber concrete, the Arc Dining Table has a tactile stone-looking surface with small holes and colour variations. Due to the product is cast and afterwards hand painted, each product is unique. Arc Dining Table comes in two pieces - table top and base, easily assembled with four screws hidden underneath the table top.

Designed by Kristian Sofus Hansen & Tommy Hyldahl.

Product no: 233004

Type: Table - Indoor

Designer / Year of design:

Kristian Sofus Hansen & Tommy Hyldahl, 2022

Colour: Coffee

Material: Fiber Concrete

Care instructions:

Gently wipe the table with a soft, dry cloth to keep the surface dust-free and pristine. Avoid using household cleaners, especially those with acidic components, to preserve the table's finish. With proper care, your Artist Dining Table will be a cherished centrepiece in your home for many years.

Dimensions: L120 / W120 / H78 CM

Weight capacity: 200 Kgs

Country of origin: CN

Product weight:

Tabletop: 31,8 Kgs

Base: 30,6 Kgs

Packaging:

Dimensions:

Tabletop: L133 / W133,5 / H16 CM

Base: L91 / W63 / H65 CM

Total weight incl. product:

Tabletop: 34 Kgs

Base: 33 Kgs

Number of parcels: 2

Material: Brown cardboard

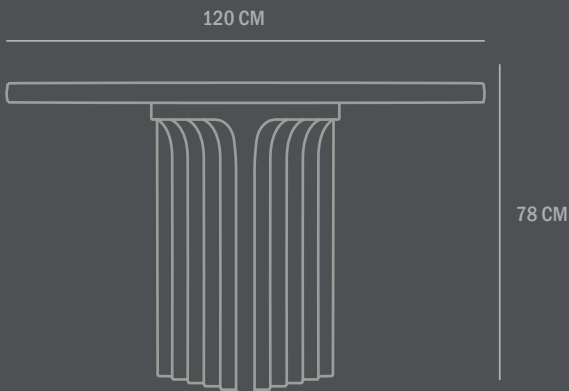
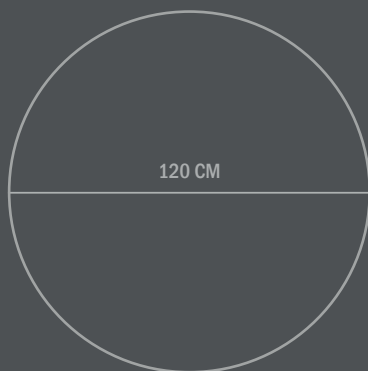

TO ASSEMBLE:

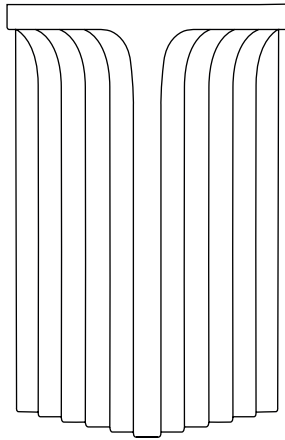

1. Place the table base on the ground.

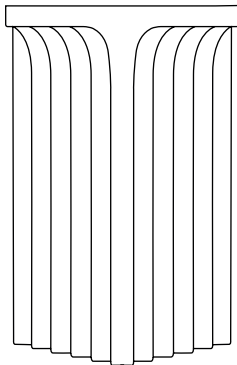
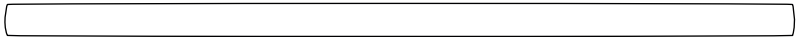

2. You will need 3-4 people to assist with positioning the tabletop onto the table base. Ensure that the groove on the tabletop aligns with the table base.

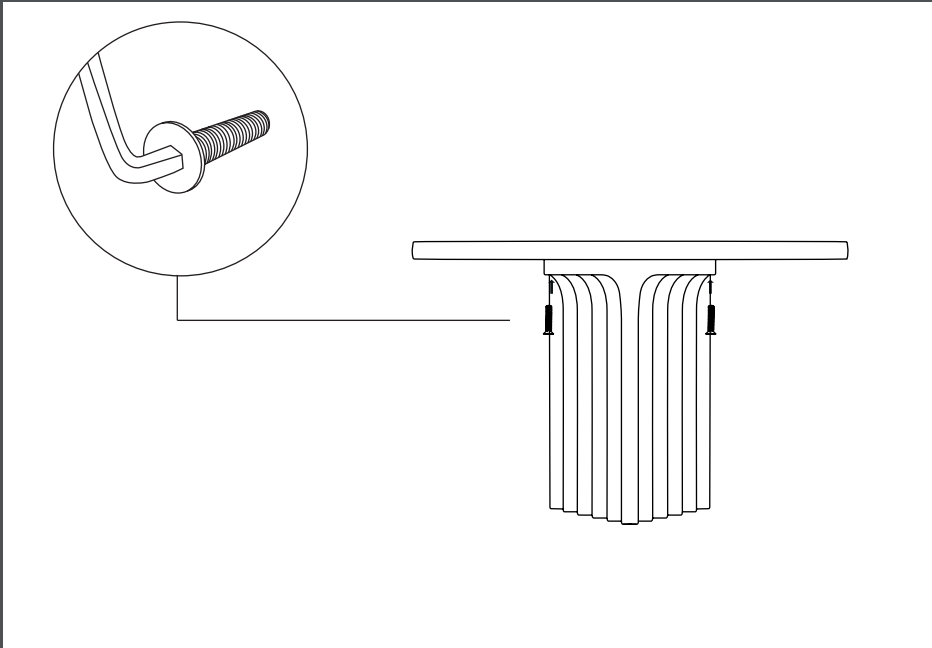

3. Once aligned, insert and align the four screws to secure the installation.

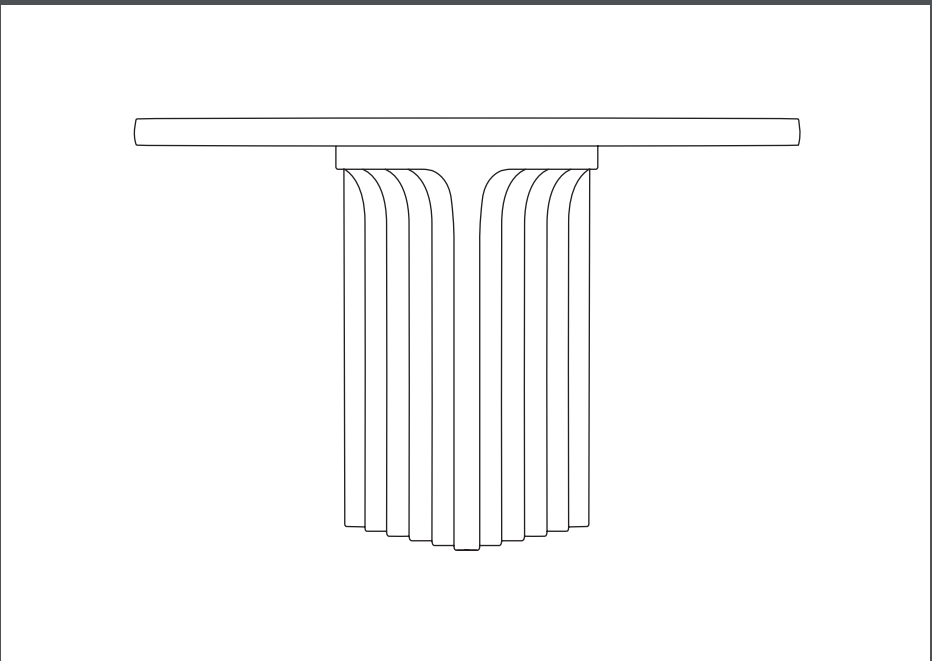

4. If the tabletop doesn't fit properly, adjust the orientation of the base or tabletop until it lines up with the screw openings intended for installation.



GLOBAL SALES INQUIRIES: SALES@101CPH.COM

SUPPORT INQUIRIES: SUPPORT@101CPH.COM

PRESS INQUIRIES: PRESS@101CPH.COM



PRESS KIT & IMAGEBANK PLEASE GO TO:

WWW.101CPH.COM OR SCAN THE QR CODE AND GAIN ACCESS TO OUR IMAGE BANK, CATALOGUE AND MORE.

SHOWROOM BY APPOINTMENT ONLY // ØSTERGADE 17, 3RD & 4TH FLOOR, 1100 COPENHAGEN, DENMARK.