

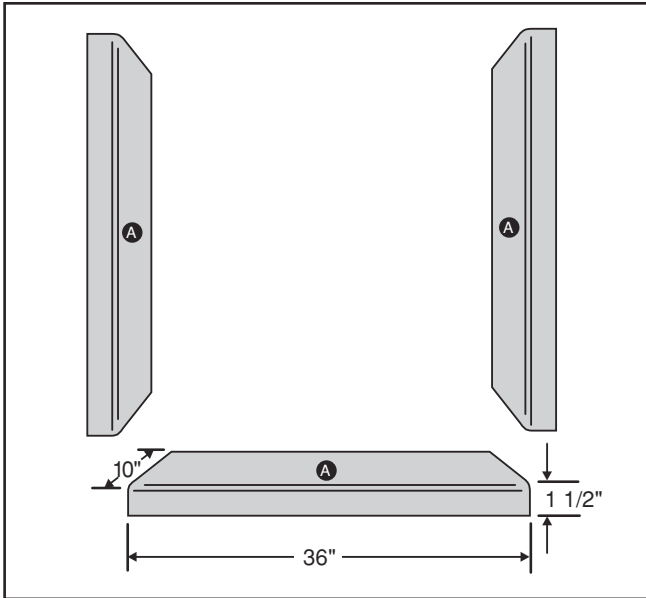

WINDOW TRIM KIT MODEL SS WTK



Installation Procedure for Swanstone Window Trim Kit MODEL SS WTK

INCLUDED IN CARTON:

A. Three sill/jamb panels

CAUTION:

Read *ALL* instructions carefully *BEFORE* starting your installation.

Save this manual for future reference

INSTALLATION OPTIONS

When installing the Swanstone Window Trim Kit, you have four options. Before you begin, decide on the application best suited for you. Allow panels to adjust to room temperature for at least six hours (65° - 90°F). The options are as illustrated below.

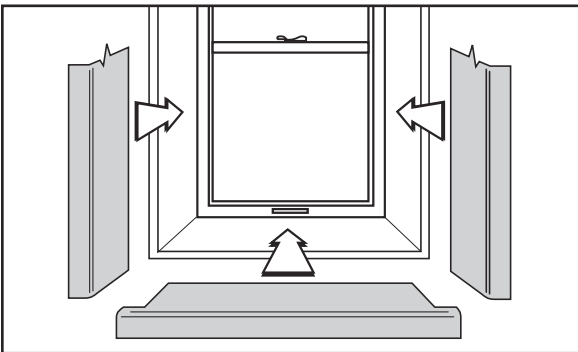

Option 1. Notching the sill panel only.

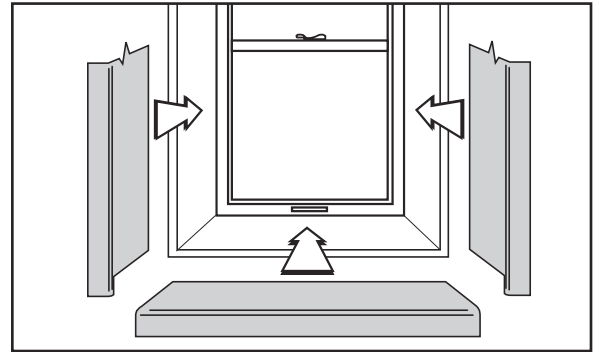

Option 2. Notching the two jamb panels.

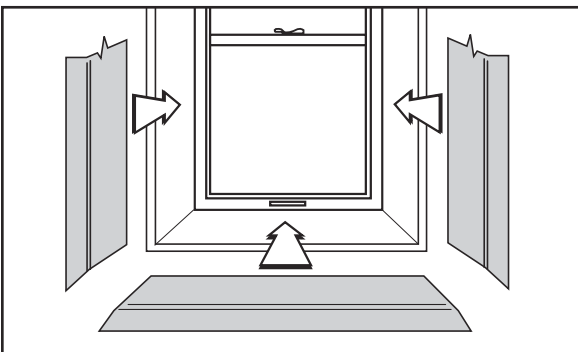

Option 3. Mitering all three panels.

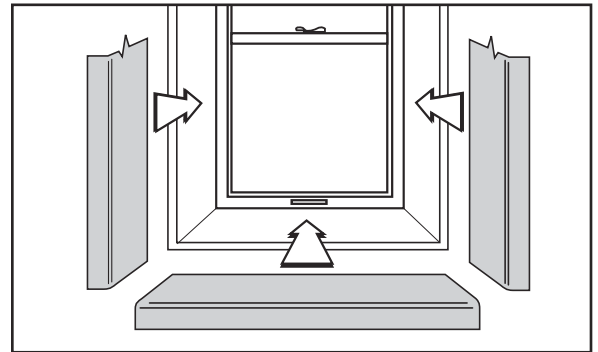

Option 4. Trimming to fit all panels with no notching or mitering.



WINDOW TRIM KIT MODEL SS WTK

TOOLS REQUIRED TO INSTALL

The only tools needed are a saber saw, ruler, and caulking gun.

DO NOT NAIL PANELS TO WINDOW SILL OR JAMBS.

INSTALLATION PROCEDURE

Remove unnecessary window moldings, if any, and clean area of dirt, chipped paint, loose plaster, etc.

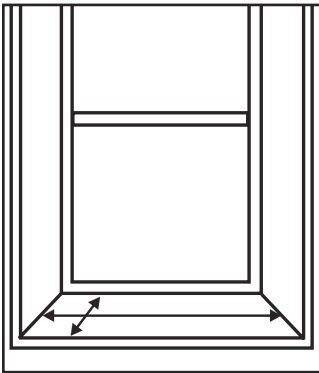

A. Taking into account the installation option you choose, measure the side of the sill opening. Then measure the depth of the sill area, mark and cut panel to exact size.

NOTE: IT IS ADVISABLE TO TRIAL FIT ALL THREE PANELS BEFORE CUTTING.

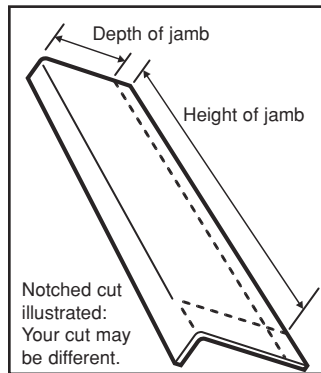

B. Cut the left and right jamb panels to the desired height and depth. Again, consider the application that you have chosen; this will determine the size of your cut. If applicable, you may wish to line up the jamb panels with the height of the tub surround material.

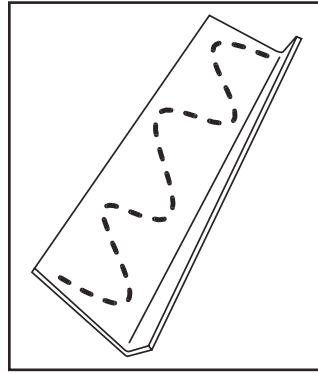

C. Apply adhesive per "S" pattern shown to the underside of the sill and press firmly into place. Repeat the same procedure for the two jamb panels. Press down on all panels to insure good contact.

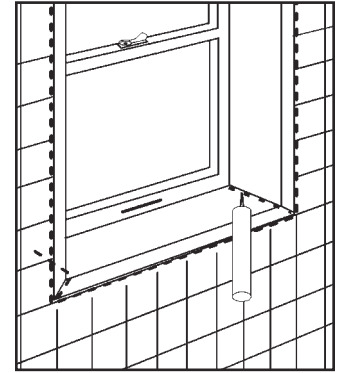

D. Caulk all edges to seal out moisture.

NOTE: ALLOW ADHESIVE AT LEAST 24 HOURS TO CURE BEFORE USING.

CLEANING

Clean your Swanstone Window Trim Kit as you would any other fine bath fixture, using normal household detergents and cleansers. Just wiping the surface quickly removes watermarks and residue. Occasional scrubbing with household abrasive cleansers maintains Swanstone's beautiful luster.

REPAIRING

Use 400 grit sandpaper to remove scratches and gouges in the surface. A "Scotchbright" pad can be used to blend the repair into the surrounding area.

