



WideWheel PRO User Manual



Introduction manual

Before using the product, please read the instructions.
Some features are subject to change without notice to improve product performance.

Important Checklist

CAUTION

To prevent safety accidents, check the product before and during use. If abnormal symptoms are found, stop using the product immediately, contact a self-examination center or a customer service center and use the product safely.

● Accelerated lever (throttle)

- ▶ Check the accelerator lever for normal operation before driving
- ▶ Before driving, check if the lever is returned to its original position.
- ▶ Maintaining smooth operation when driving
- ▶ Check or replace if there is a large gap or impact of the acceleration lever
- ▶ Requires regular inspection of the bolts that secure the accelerator lever.

● Folding part, fork, and neck part

- ▶ Extreme and stunt driving is strictly prohibited.
- ▶ In the event of heavy operation of equipment carrying the weight of the handle and the fixed bolts on the showed part, neck, and fork parts, the associated parts may become stressed, and may become less binding and loose due to fatigue damage or deformation, and parts need to be replaced after a certain period of use.

⚠ WARNING

- ※ Ensure that bolts, nuts are secure and free from loss wherever the product is constructed
- ※ Signs of crack and other damage must be verified always before use
- ※ Check that the folding fasteners are securely fixed before use.

● Brake

- ▶ Replace cables if they are not operating smoothly
- ▶ When operating the brake lever, after a major impact, such as a fall, the brake lever must be inspected or replaced
- ▶ Prior to driving, the braking force must be checked at all times.

- ▶ Check brake function and brake pad consumption
- ▶ Replacement is required when the disc is deformed or stamped and calibration is not possible.

● Front and Rear Suspension

- ▶ Ensure that the mounting bolts and nuts are tightened.
- ▶ After a fall, major impact, etc., check the suspension arms for damage and replace them before use
- ▶ If a certain amount of time is spent and there is a decrease in resiliency and other functions, please replace before using



Please familiarize yourself with the manual before using the product. Some features can be changed without prior notice to improve the performance of the product.

WARNING

◆ General safety precautions

- ▶ Do not allow water to flow into the components of the product.
- ▶ All wet conditions such as rain, snow, hail, etc. are prohibited. Clean with water is a source of trouble and subject to fire. Any defects will be paid within the warranty period
- ▶ Any disassembly, modification or modification of products and components is not warranted and the manufacturer and dealer is not responsible for any problems caused by them.
- ▶ Unlicensed, drunk driving and cargo-loaded driving are prohibited. Observe the Road Traffic Act and related statutes according to the location of use.
- ▶ Extreme driving and dexterity driving are prohibited because the product is severely impacted, causing failure and accident. Manufacturing and retailers will not be responsible for any problems caused by this.
- ▶ Users who are not familiar with the product are at high risk of a safety accident and are encouraged to drive at low speed. For safety reasons, beginners should practice riding safely in a large area before using it.
- ▶ Acceleration on the downhill is very dangerous because braking distances are longer and visibility is difficult, so do not accelerate at all and the brakes should be used properly to slow down. Stop driving and lower the heat of the brake disc as the brakes may overheat on very long downhill roads.
- ▶ Please be careful not to injure yourself when moving the product after folding.

◆ Prerequisite checks before driving

- ▶ Before use, check the tread plate tightening bolts, tire conditions, other equipment conditions, and safety conditions.
- ▶ Protective equipment (heels, gloves, upper body protection, knee, elbow protection, joint protection, etc.) must be worn before use.
- ▶ Check the acceleration lever (throttle) for normal operation before driving and refrain from the sudden operation.
- ▶ If the braking force is insufficient, change the pads, adjust the gap, and adjust the brake after checking the brake magnetic field.
- ▶ Turn on the power to check the remaining battery capacity before driving.
- ▶ Avoid driving at night for safety reasons, and In case of unavoidable night driving, please consider the surrounding situation and drive safely at low speed.
- ▶ Please make sure to drive with the driving mode that suits you.
- ▶ Practice slowing down and stopping slowly to cope with possibly unexpected situations when driving.
- ▶ When turning left and right, slow down sufficiently to avoid the risk of rollover, check if there are any obstructions, and then keep the wide radius and turn slowly.
- ▶ Be sure to hold and use the handle with both hands, and always hold the handle to ensure that the brakes are immediately held in case of unforeseen circumstances.

Precautions

- ▶ Safety precautions..... P. 01

Components and name

- ▶ Component guidance..... P. 02
- ▶ Names of external components..... P. 03

Dashboard

- ▶ Name and setup of the instrument panel..... P. 04

Driving

- ▶ Driving method..... P. 05

Folding

- ▶ Folding method..... P. 06

Battery

- ▶ Charging the battery..... P. 07
- ▶ Usage and management of lithium-ion batteries..... P. 08
- ▶ Precautions for battery charging..... P. 09

Product Specifications

- ▶ Specification..... P. 10

Exchange / Refund / Warranty Period / Related to A.S.

- ▶ Product Exchange, Refund and Warranty periods..... P. 11
- ▶ AS Tip guide..... P. 12

– Please, read the following notes before using the products.

- 1) Please read this manual before using the product.
- 2) After you read it, please keep it where easy to find.
- 3) Under the Korean Road Traffic Law, wide heels are classified as prime movers.
- 4) In this User's manual, some device-based features and items may not be available or may be optional.
- 5) There's some different used image in the cover and main text from actual product.
- 6) This product and its documentation subject might be changed without notice.



WARNING

- ▶ This product is made for single use. Do not burn your passenger.
- ▶ Do not change mechanical structural.
- ▶ Do not drive in environment with a risk of accident.
- ▶ Do not Sudden turning during driving.

◆ Safety Prevention Principle

- ▶ Do not carry out any dangerous movements, and always put both hands on the handlebars.
- ▶ Do not drive on angled jaws(hills) or stairs
- ▶ Do not carry heavy objects on the handle bar
- ▶ Electric products may cause corrosion or breakdown in wet environment. It is recommended to use in sunny weather.

◆ Safety accident prevention

- ▶ Please wear safety protective gear (helmet, protector, etc.) when driving.
- ▶ Please pay attention to terrain and ground. If you are driving on unpaved roads, please drive slowly.
- ▶ Please refrain from operating on roads with many vehicles.
- ▶ The electronic control system of this product has been developed with safety first, so please do not change the electric circuit or install other electric devices.
- ▶ If the battery gauge has only one space remaining, stop operation and charge it.
- ▶ Regularly check the connection status between the wires and the connector.
- ▶ Avoid driving in places where people are crowded or where pedestrian safety is a concern.
- ▶ Do not use it on slippery places or ice roads due to water.
- ▶ Do not use it on steep grades over 15 degree.
- ▶ Do not use on rainy and snowy days.
- ▶ Be safe at low speeds on ramps.
- ▶ For safety during operation, please operate safely within 20km/h.

– Component guidance



Wide Wheel PRO Body



Battery Charger

The battery charging adapter and charging gender are shipped connected

※Please note that the charging terminal will be damaged if the charging connection is impacted while the charger is connected. The lithium ion battery must be charged only with the charger included with the product. If you charge the battery with a non-standard or non-certified charger, it may cause product failure or fire.



User manual

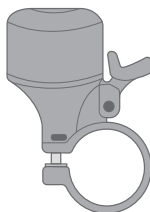

Bell



Hex Key
and other tools

Components and names

CONSTRUCTION

– Names of external components

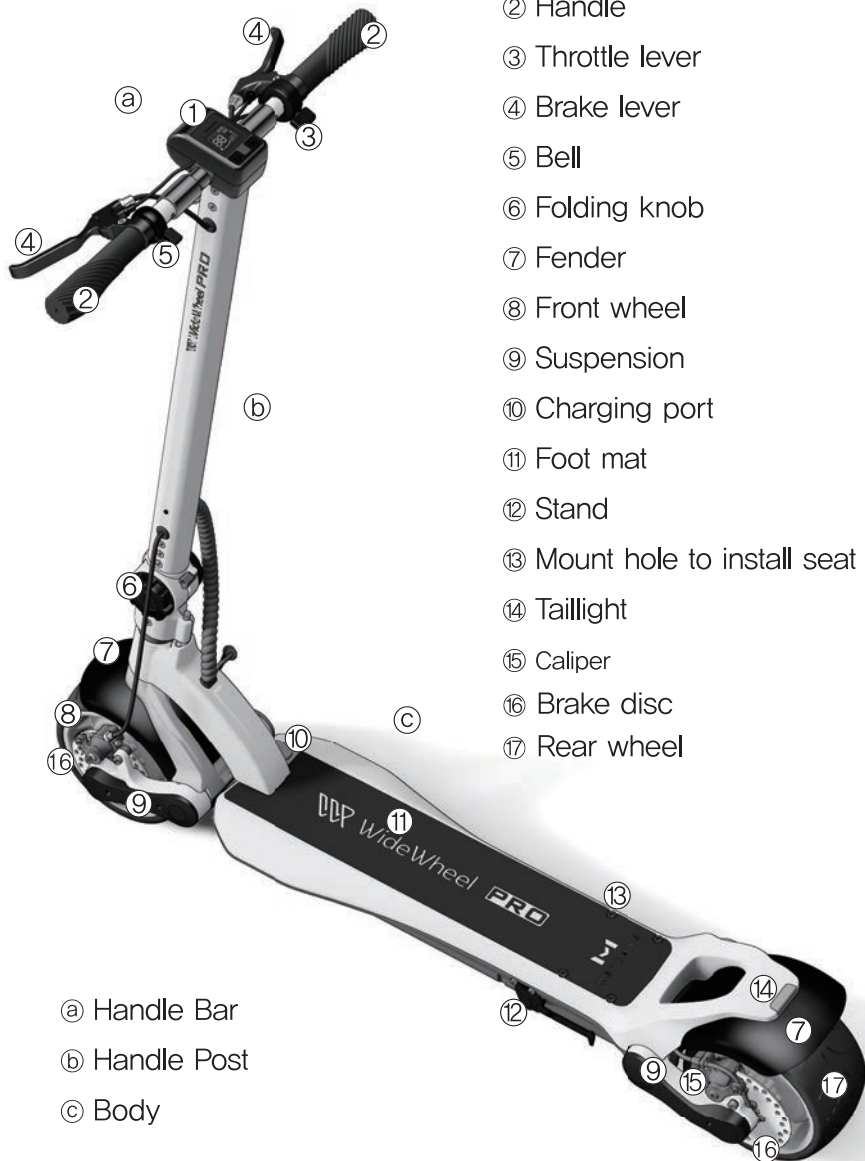



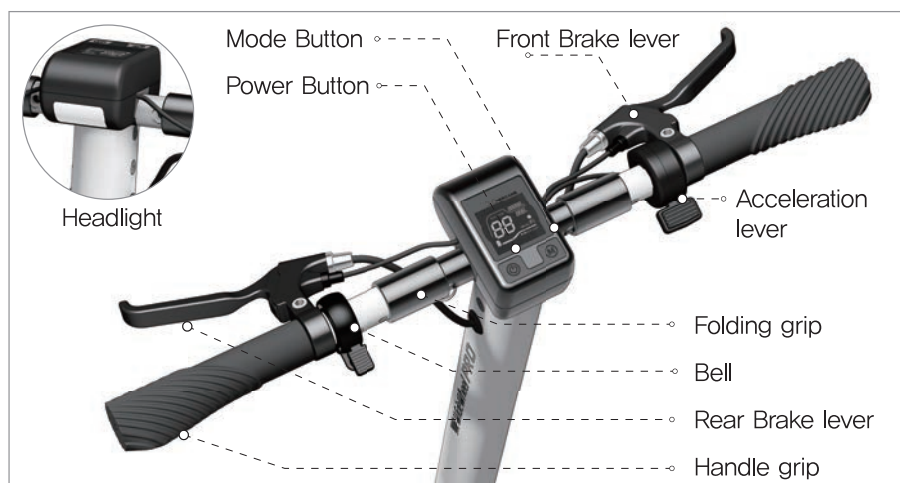

– Name and setup of the instrument panel

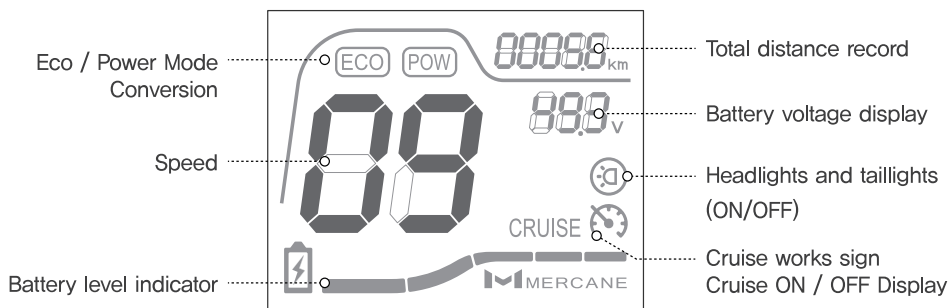

– Instruction



– User driving settings:

- ① Pressing the  button (power button) for about 2 seconds turns the power ON. When Power is ON, , press the button for about 2 seconds to turn OFF the power.
- ② When Power is ON , press the button once to switch the modes: ECO/POWER.
- ③ When Power is ON  press the button (mode button) once to turn the Headlamp / Taillight ON/OFF.
- ④ When Power is ON  press the button for 2 seconds to turn the cruise control ON/OFF.

– Driving Method

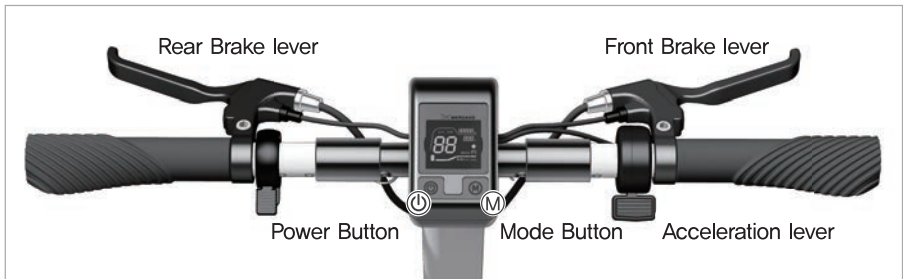

- ① Pressing the button for about 2 seconds turns the power ON.
- ② Set the desired driving mode (check the "dashboard setting")
- ③ When Power is ON, push the scooter and gently press the accelerator to operate.
- ④ Use the brake lever to slow down and stop.
- ⑤ When Power is ON, , press the button for about 2 seconds to turn OFF the power.

► Please note, there is a built-in kick & go function, so when driving for the first time, push the product with one foot so the kickboard can move forward. After doing so, you must use the accelerator to drive.

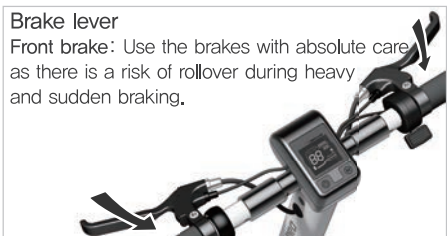

Brake lever

Front brake: Use the brakes with absolute care as there is a risk of rollover during heavy and sudden braking.

※ Please, use extra caution to keep safe driving while using the front and rear brake. You must have basic knowledge about characteristics before use.

◆ Driving mode can be selected manually according to the user's desire.

Eco mode :

This mode allows smooth and efficient driving by adjusting the output and acceleration.

Power mode :

Users can use maximum output and torque of the product.

This mode allows active driving with fast response speed. However, in Power mode, the speed is automatically limited when the speed exceeds 25 km/h according to law.



If you brake continuously on the downhill, you must be cautious of the use as it may cause the brake function deterioration and accidents. Also, be sure to drive safely at low speed as it may cause damage to the motor and controller during excessive driving.

– Handlebar folding method

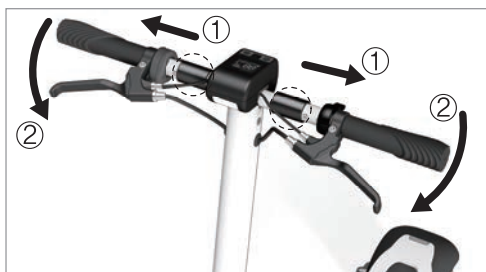

Ⓐ Pull the handlebar folding control cover in the direction of the arrow and lower the handle in the downward direction.



Ⓑ When you open it, hold the handlebar and slowly move it upwards to return the folding control cover to its original position.

– Handlepost folding method



Ⓐ Loosen the folding knob 7–10 turns in the direction of the arrow (counterclockwise).

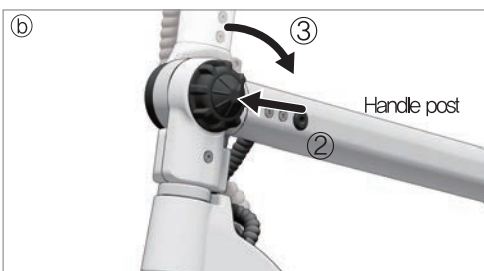

Ⓑ Push the folding knob in the ② direction and push the handle post in the ③ direction when the handle post is pushed to the right – the lock is released.

Ⓒ Lower the folding knob until the handle post 'clicks' and then turn the folding dial in the opposite direction to tighten it.

Ⓓ Unfold the product in the reverse order of folding, then tighten the folding dial to secure the handle post.

- ※ When the product is first received, it is folded. Turn the folding dial 7 ~ 10 times and push the folding dial to unlock it. Then, lift up the handle post until it locks, and then tighten the folding dial.
- ※ Lock the folding dial firmly so that the folding does not loosen while driving.

– Charging the battery



Open the charging port on the front of your Wide Wheel (as shown in the picture above) and connect the power cord into the charging port.

◆ Charging Instruction

- ▶ Charging port is located on the right side of the front wheel.
- ▶ Charge your batteries for 6–7 hours and do not charge your batteries for more than 10 hours to prevent the batteries from overheating.
- ▶ Charge the battery when driving slows down.
- ▶ When the Wide Wheel is plugged in and charging, charger LED will be red.
- ▶ When the battery is charged, indicator turns into green.
- ▶ Charging should be done only in well ventilated room.
- ▶ Battery pack is consumable device. Please, replace to new one when battery life time serves less than half of initial battery life.
- ▶ The product cannot be operated while the battery is charging.

◆ Charger connection guide

▶ If you connect the charger to the product and then plug the outlet, it may cause a spark. Please make sure to charge in the same way as the connection procedure below.



- ① Connecting adapter to charging port
- ② Connecting charging plug to wall outlet
- ③ Connecting charging port to product

– Using and managing Lithium Ion batteries

**Warning**

- ▶ Must be using the standard charger supplied with the product. Using non-standard charger may cause product malfunction and topic.
- ▶ It should be charged from 0 to 40 degrees Celsius, and should be stored at temperatures between –20 and 60 degrees Celsius. Charging or discharging at temperatures over this range may damage the battery.
- ▶ To avoid exposed to direct sunlight for a long time or in high temperatures. Charge the product and charger in a safe place with no flammable material around.
- ▶ If you enter the warm space from the cold outside in the winter season, it may cause condensation inside due to the temperature difference. Do not charge it immediately and charge it after the temperature difference decreases after a certain period of time.
- ▶ If the protection circuit is damaged If there is any leakage or smell from the battery, stop using it immediately and contact the place of purchase for technical support and service.
- ▶ Care should be taken to avoid exposure to children or pets.
- ▶ Be careful not to short-circuit the charging terminal or change the polarity, and be careful that the battery may be damaged or explode in case of external shock or short circuit.
- ▶ If multiple Li-ion batteries are assembled and the product is packed and subjected to excessive external impact, the battery will be damaged due to electrode separation and short circuit, which increases the possibility of ignition. Therefore, when the battery is installed in the product, you must not run for a long time in uneven road surface, do not carry jumps or drops, and check the battery if a strong shock from the accident is applied to the battery.
- ▶ In the event of flooding, stop using it immediately and contact your dealer for assistance. Do not connect the charger to water because there is a risk of electric shock when flooded.
- ▶ Do not disassemble it. It is prohibited to incinerate when disposing. It should be classified as industrial waste and care should be taken to avoid shorts at the terminals.
- ▶ It has a characteristic that the discharge performance is reduced by 10% or more when charging and discharging 300 times or more. If the battery usage time becomes too short due to long use, the battery should be replaced through the place of purchase.
- ▶ Energy density is very high so, there is a possibility that if the battery pack is charged for a long time under short-circuit, short-circuit, leakage, or battery failure, it may be ignited. Therefore, it should be avoided to charge the room indoors for a long time in the absence of a person, or to charge for a long time while sleeping at night.

– Battery charging precautions

Warning

◆ To prevent fire and electric shock

- ▶ Be sure to use the charger and battery supplied with the product
- ▶ Do not use the battery and charger of this product for other products. Over-heating, fire, explosion may occur.
- ▶ Never modify the electrical circuit. Any manipulation of the electric circuit may cause shock, fire, explosion and damage to the product.
- ▶ Do not charge the battery while it is charging. Charging should only be done in a well-ventilated room.
- ▶ Do not carry the battery by the wire or charger. Doing so may damage the battery or cause a fire. When lifting the battery, hold the battery case.
- ▶ The built-in battery may cause fire due to strong shock or high temperature.

◆ Handling Precautions

- ① If you are not going to use it for a long time, please separate the battery and connection cable.
- ② You must recharge and maintain it at least once a month to use the battery longer.
- ③ Since the battery is a consumable item, it is not a free A / S item. Please use it after repacking in case of complete discharge.
- ④ Operating in sub-zero weather conditions can significantly reduce battery life, so please do not use below minus 5 degrees.
- ⑤ Be sure to familiarize yourself with the characteristics of charging and discharging
- ⑥ Disassembling or tuning the product without going through the designated service center may cause the product to malfunction.

- ▶ Do not disassemble or repair the battery.
- ▶ Do not drop the battery. It may permanently damage the battery and cause serious injury.
- ▶ Before charging the battery, check the battery, charger, connector, and connectors for damage. If the battery, charger and related parts are damaged, stop charging.
- ▶ Do not completely discharge the battery. After using the battery, please be sure to fully charge the battery. If not used, charge it regularly at least once a month.

SPECIFICATION

SPECIFICATION

– WideWheel PRO SPEC

TYPE	SPECIFICATION
Motor	48V 500W BLDC Hub Motor / Dual front and rear
Battery	48V 15Ah (optional) Lithium Ion
Charging time	5~7 hours
Max Speed	25km/h (speed limit)
Driving Range	70 Km(depends on driving condition)
Max Climbing Ability	<25% ~ <40% (Different / depending on single or dual)
Weight limits	100kg
Suspension	Link type front and rear suspension
Braking method	Disc breaking
Headlamp / Taillight	LED Lamp
Tire	100mm wide tire / aluminum
Product weight	22 kg
Overcurrent Protection Device	Software : Auto Power OFF when current exceeds 15 A
	Battery : Protection module (PCM) installed / Power is automatically turned of due to slow battery transferring
	Short circuit and Interruption protection : Battery protection with short circuit detection and circuit protection

Product Dimensions

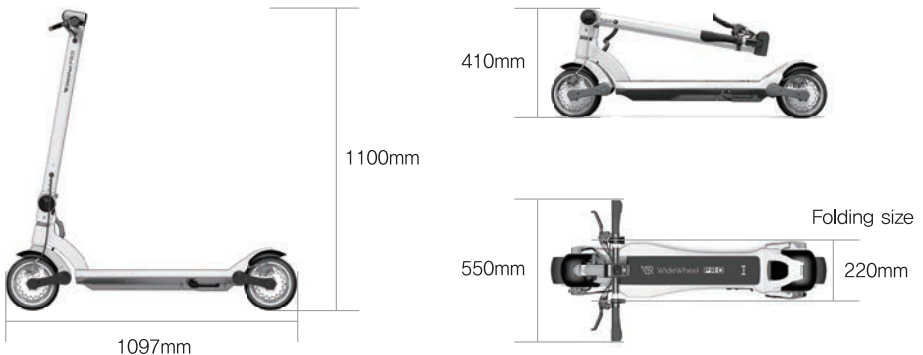

※ To improve quality and safety of the product, the specifications might be changed without prior notice.

EXCHANGE /REFUND . WARRANTY PERIOD GUARANTEE

– Product exchange, refund and warranty period

© Exchange and Refund Policy

◆ Product exchange regulations _____

- ▶ If product is different from purchased model
- ▶ If product is damaged during delivery time
- ▶ In case of requesting hardware order within 7 days after purchase
- ▶ If trouble occurred after repairing same area three times
- ▶ If failure occurred within warranty period

Notice

- 1) The exchange is made by individual parts (exp.: if the wheels fail, only wheels will be exchanged)
- 2) For exchanges without any damages, customer has to pay round delivery fee.
- 3) If other accessories or parts are defective, they are replaced with those parts only.
- 4) Remuneration is made within 14 days from the notification date.

◆ Refund Policy _____

- 1) If product is different from purchased model
- 2) If it is needed to repair important hardware within 7 days after purchase
- 3) If customer wants to exchange or refund due to simple remorse without defect within 7 days after purchase. In this case, all round delivery fee is covered by customer.

◆ Exchange and Refund Not Applicable _____

- 1) If the accessories and parts are defective, it is not eligible for a refund.
- 2) If the software is defective it is not eligible for exchange / refund.
- 3) If the product opened and judged to be defective as a new product, it is not eligible to return.
- 4) If customer does not have a product purchase receipt or proof , customer is not able to get a refund.

– A.S Tip

◆ If power is ON, but product still does not operate

- ▷ Wide Wheel PRO is a product with built in kick function. It can be operated after pushing the product with one foot.
- ▷ Also, the setting mode must be changed into driving mode to operate

◆ If there is noise, when rear wheel is equipped with disc brake.

- ▷ Please refer to the guideline of manual, and adjust the contact area between the pad and the disc to optimize braking operation.

◆ If the brake is pushed, a wire type disc brakes.

- ▷ Needs to adjust the sensitivity depending on the user's preference.
Adjust the brake sensitivity by referring to the manual and Mercane's official website.

◆ When folding the product, the folding bar is disengaged.

- ▷ Wide Wheel PRO has a scale folding system to minimize device's portable function.
If you turn the folding dial as much as possible,
it will be removed. Turn it 7~9 times and refer to the User Manual.

◆ If there is a problem with changing and understanding of operating modes.

- ▷ Wide Wheel PRO uses only most necessary and intuitive dashboard. Please be sure to familiarize yourself about functions and operating methods with the manual and videos from Mercane's official websites while using the product first time. .

※If you have any further questions or inquires ,
please contact us at www.mercane.com or Mercane Customer Center.

MEMO

MEMO

MEMO



The most comfortable and
stylish E-Scooter "WideWheel Pro"



WideWheel PRO Introduction manual
<http://www.mercanemall.com>