





Unlocked



Locked

HLS™ 9000 Features & Benefits

- Stainless Steel is highly corrosion resistant.
- Retractable hooks create a clean look on the door and jamb when open.
- Two point locking system allows for optimum locking point contact with the jamb to assure passing the most stringent forced entry testing.
- Mishandling device prevents retractable hooks from accidentally firing and potentially damaging the hardware, door or frame.
- Manual lock operation eliminates inadvertent locking of the door.
- Limited Lifetime Mechanical Warranty.
- Available in 30 mm & 35 mm backset.
- Full-length faceplate available to cover continuous.
- Faceplate with radius at top and bottom available for simplified door edge preparation on tall doors.
- Easily adjustable strikes help solve the problem of door panel movement or settling of the house.
- Exceeds the current 100,000 operational cycle testing requirements.

Sliding Door Trim Features & Benefits

- Solid brass forged handles and backplates.
- Single design theme means corresponding finishes and styles for both sliding and hinged doors.
- Spring assist for easy locking of the system.
- Locked or unlocked status of the door can be easily seen from a distance due to 90 degree cylinder operation.
- Matching dummy trim available for passive panel door.
- Resista® finishes have a Limited Lifetime Finish Warranty.

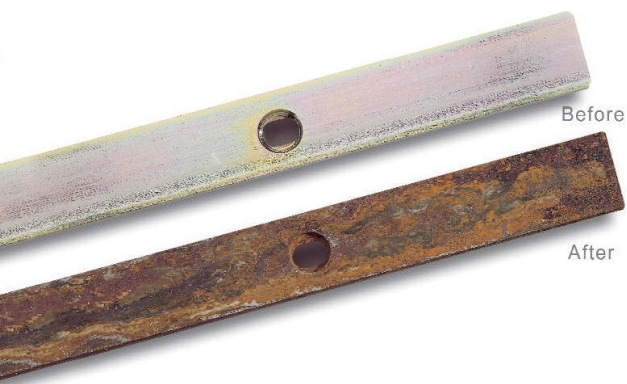

3,000 hours Salt Spray Test
Stainless Steel

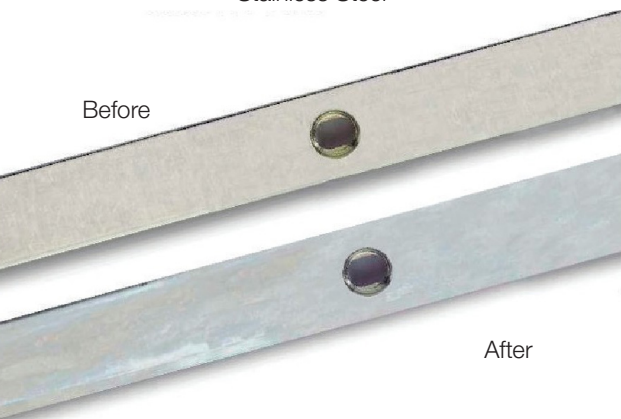

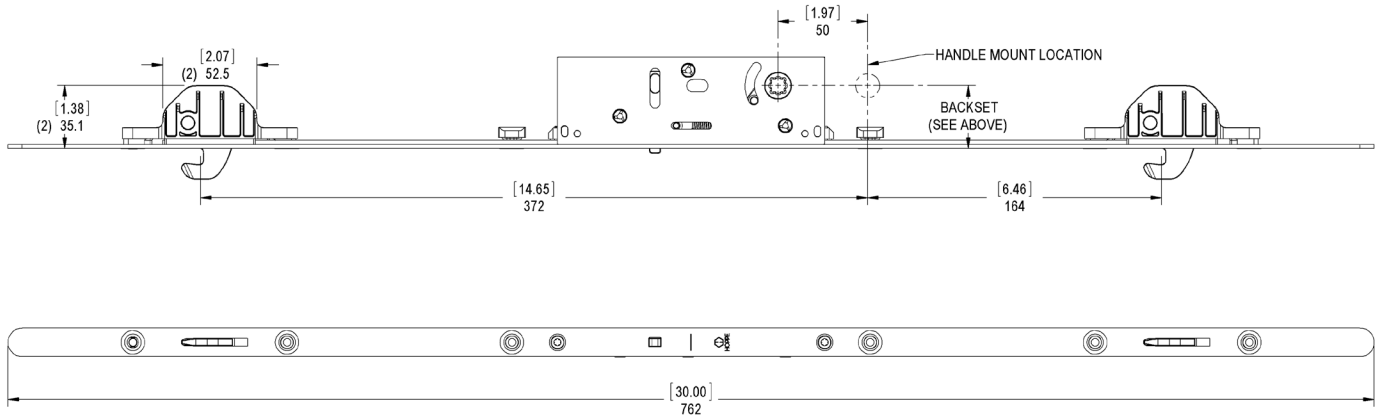

16mm Faceplate Gear

Description	Part Number
30mm backset gear	2082775
35mm backset gear	2082783

20mm Faceplate Gear

Description	Part Number
30mm backset gear	2184018
35mm backset gear	2184000

Strike

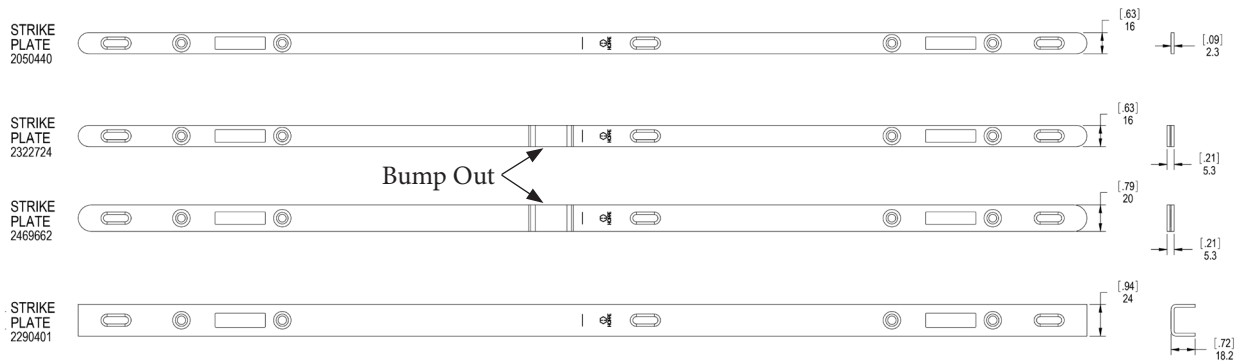

16mm Strike

Description	Part Number
Strike 16mm	2050440
Strike 16mm	2322724

20mm Strike

Description	Part Number
U-Rail Strike	2290401
Strike 20mm	2469662

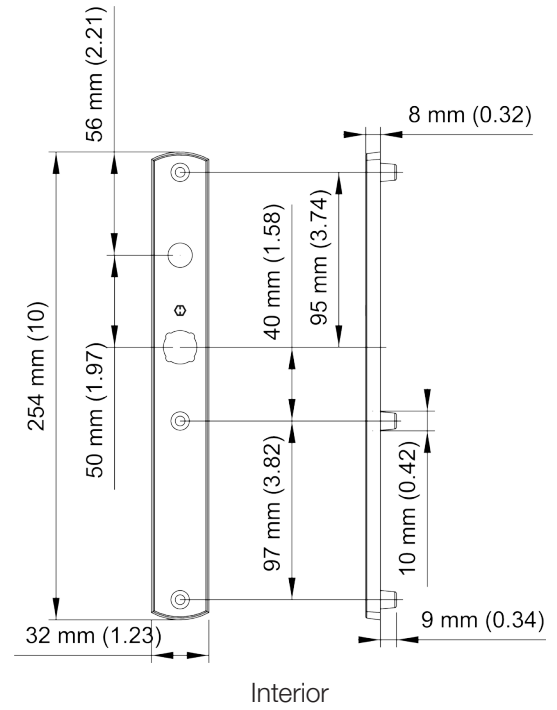
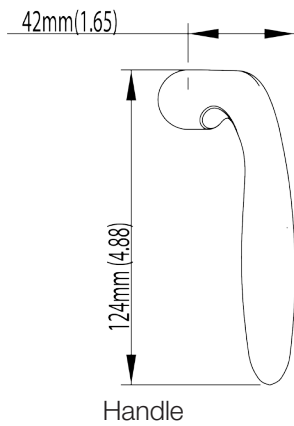
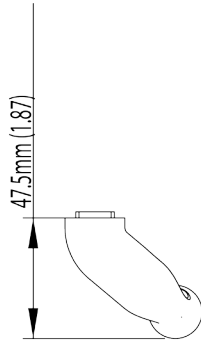
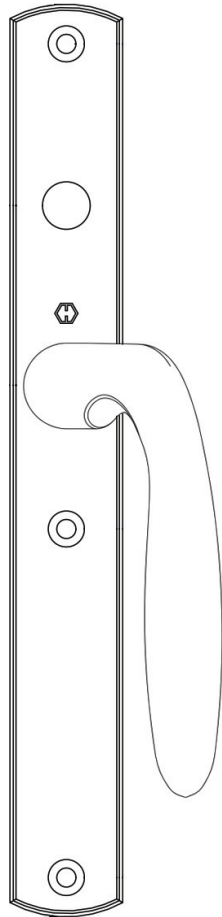

Interior

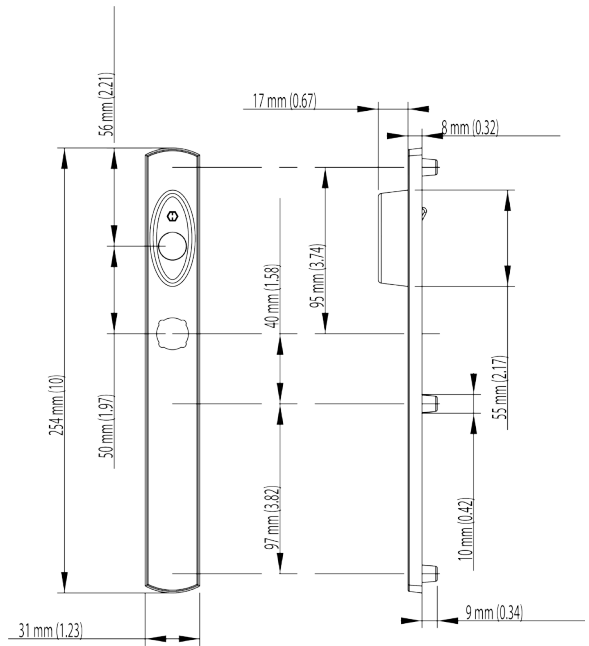

Exterior

M151VK/M2165N	F77-R Resista Brass	F73 Antique Brass	F41-R Brushed Chrome	F49 -R Polished Chrome	F9010 White	F9714 Matte Black	F42-R Satin Nickel	F44-R Antique Nickel	F79 Oil Rub Brass	F8709 Rustic Umber
Active with Cylinder	2081959	2081967	2081975	2081983	2081991	2082003	2082011	2082020	2082038	2083743
Active without Cylinder	2082492	2082505	2082513	2082521	2082530	2082548	2082556	2082564	2082572	2083807
Dummy Pair	2082927	2082935	2082943	2082951	2082960	2082978	2082986	2082994	2083006	2165757

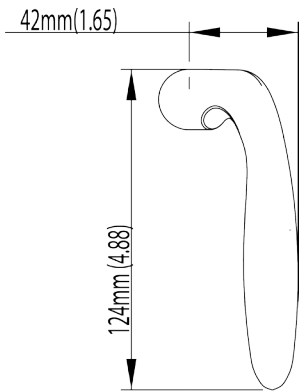
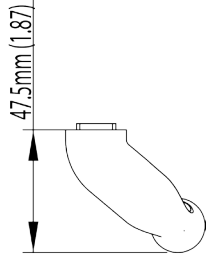
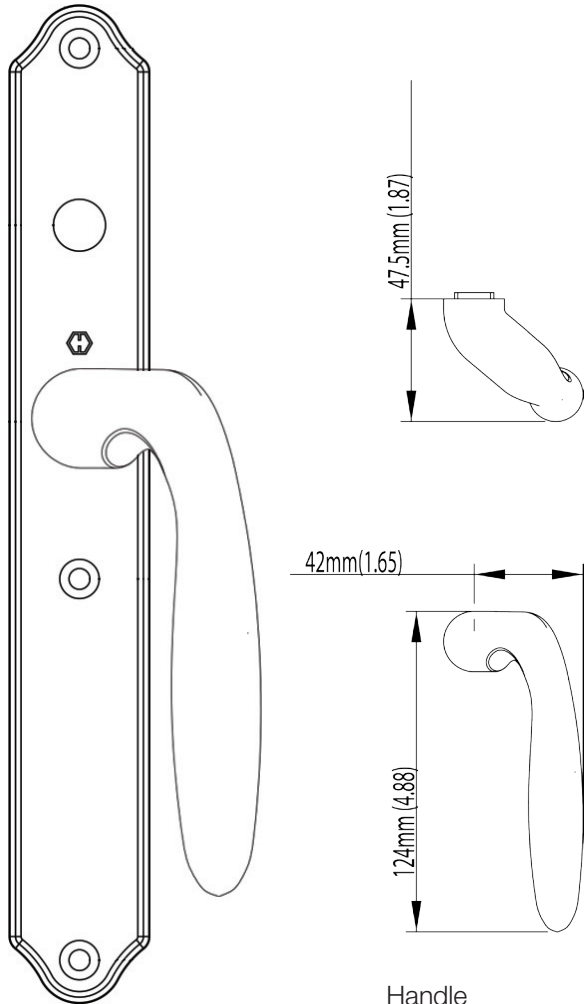

Handle

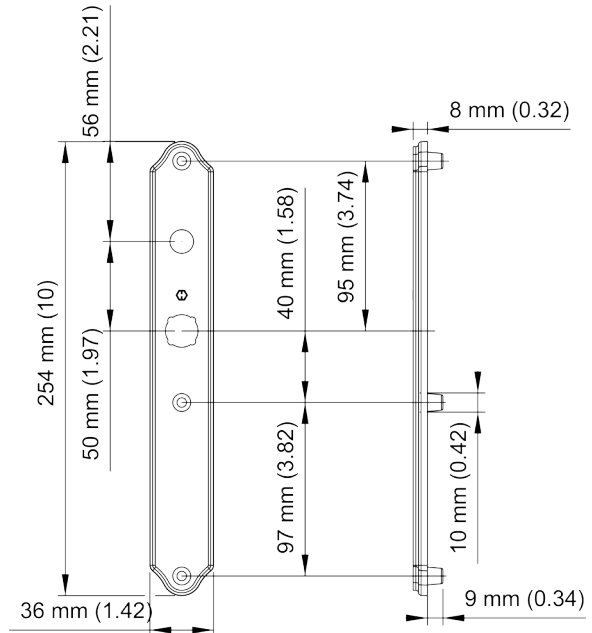

Interior

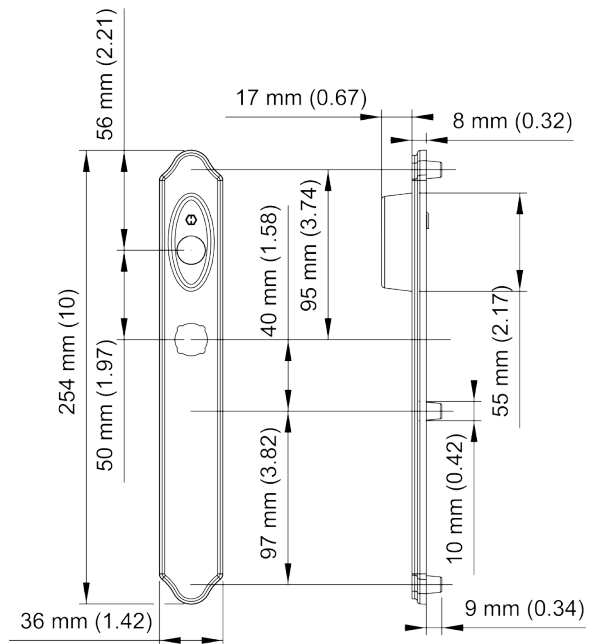

Exterior

M151VK/M2170N	F77-R Resista Brass	F73 Antique Brass	F41-R Brushed Chrome	F49 -R Polished Chrome	F9010 White	F9714 Matte Black	F42-R Satin Nickel	F44-R Antique Nickel	F79 Oil Rub Brass	F8709 Rustic Umber
Active with Cylinder	2081684	2081692	2081705	2081713	2081721	2081730	2081748	2081756	2081764	2083735
Active without Cylinder	2082222	2082231	2082249	2082257	2082265	2082273	2082281	2082290	2082302	2083794
Dummy Pair	2082839	2082847	2082855	2082863	2082871	2082880	2082898	2082901	2082919	2165749

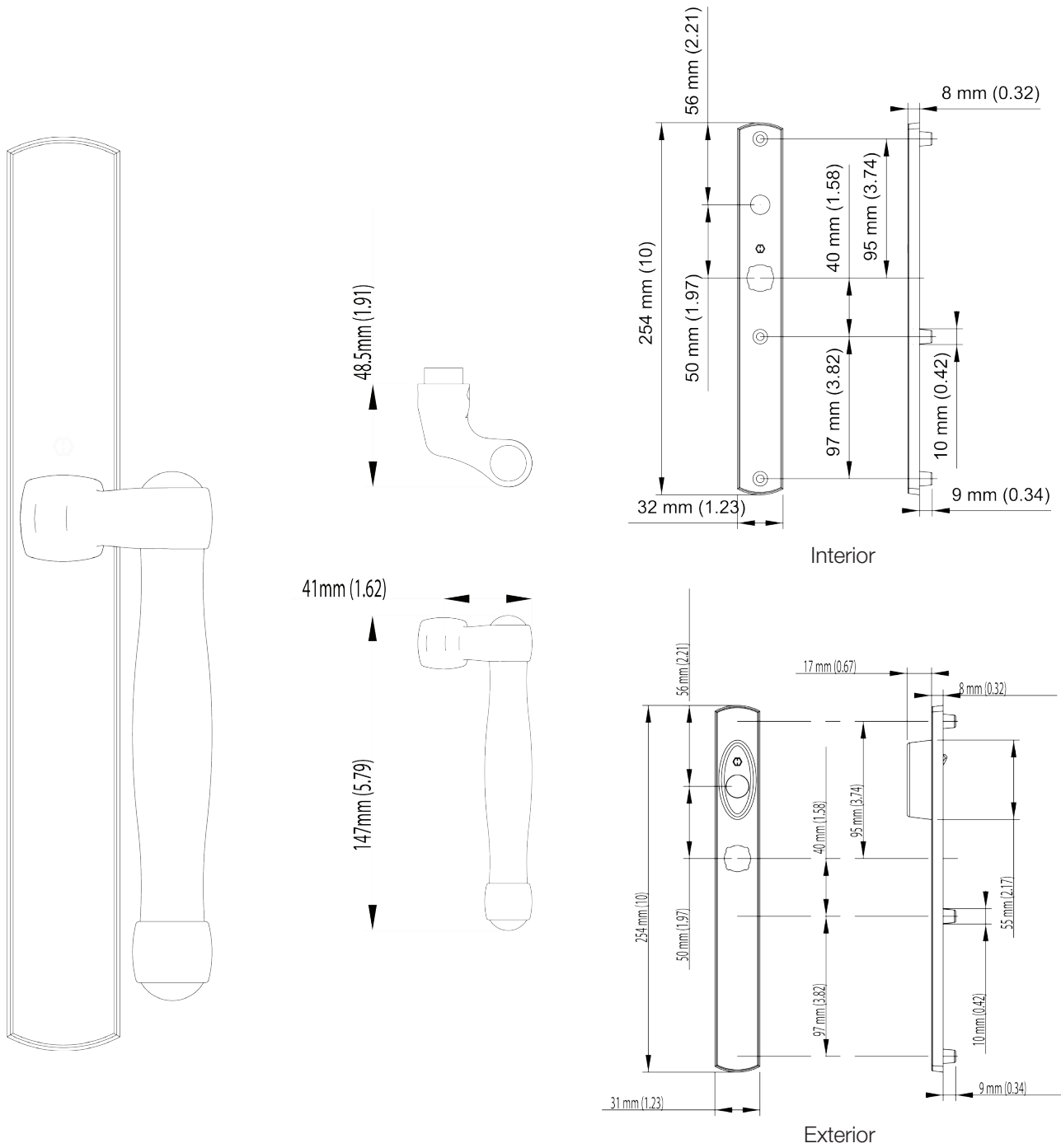

M574/M2165N	F77-R Resista Brass	F73 Antique Brass	F41-R Brushed Chrome	F49 -R Polished Chrome	F9010 White	F9714 Matte Black	F42-R Satin Nickel	F44-R Antique Nickel	F79 Oil Rub Brass	F8709 Rustic Umber
Active with Cylinder	2082134	2082142	2082151	2082169	2082177	2082185	2082193	2082206	2082214	2083786
Active without Cylinder	2082679	2082687	2082695	2082708	2082716	2082724	2082732	2082741	2082759	2165731
Dummy Pair	2083284	2083292	2083305	2083313	2083321	2083330	2083348	2083356	2083364	2165790

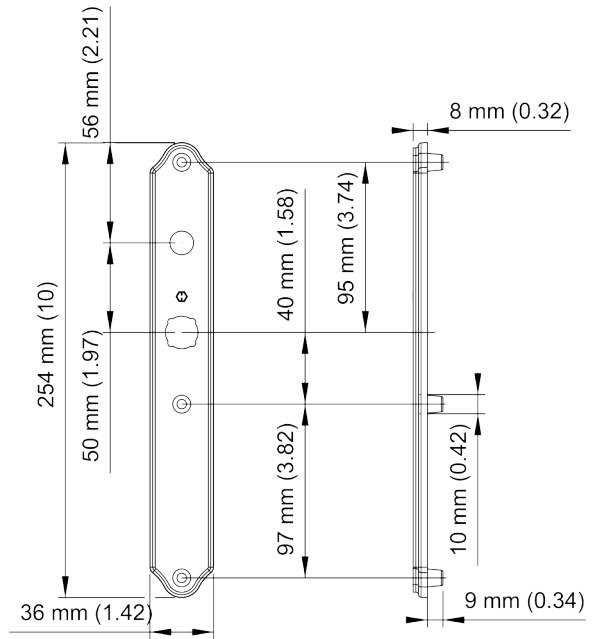
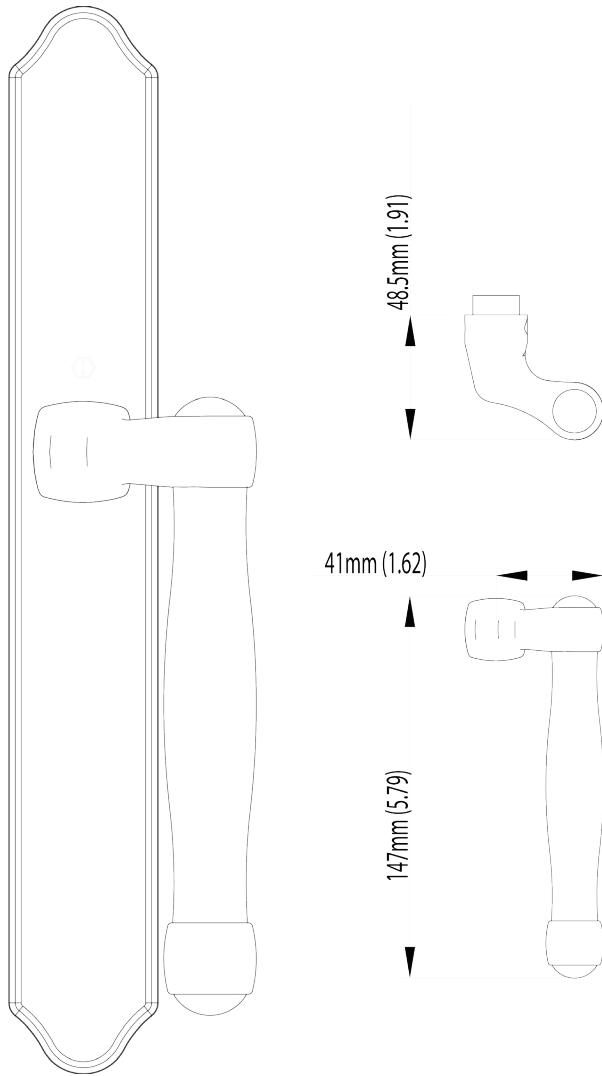

Interior

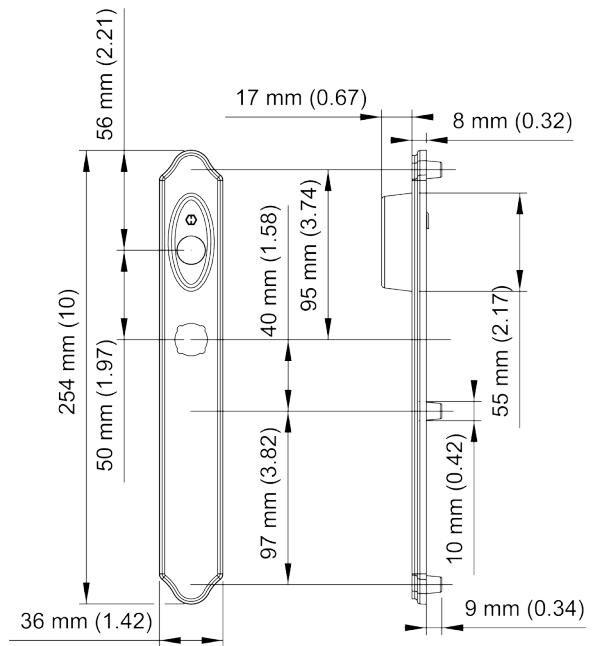

Exterior

M574/M2170N	F77-R Resista Brass	F73 Antique Brass	F41-R Brushed Chrome	F49 -R Polished Chrome	F9010 White	F9714 Matte Black	F42-R Satin Nickel	F44-R Antique Nickel	F79 Oil Rub Brass	F8709 Rustic Umber
Active with Cylinder	2081861	2081879	2081887	2081895	2081908	2081916	2081924	2081932	2081941	2083778
Active without Cylinder	2082409	2082417	2082425	2082433	2082441	2082450	2082468	2082476	2082484	2083831
Dummy Pair	2083196	2083209	2083217	2083225	2083233	2083241	2083250	2083268	2083276	2165781



03/14/????

HOPPE North America, Inc.
205 E. Blackhawk Drive
Fort Atkinson, WI 53538-1268
 920-563-2626
 920-563-4408

HOPPE North America, Inc.
6345 Netherhart Road, Unit #1
Mississauga, ON L5T 1B8
CANADA
 905-564-7344
 905-564-7301

1-888-485-4885
 info@us.hoppe.com
 www.us.hoppe.com
com