

HLS®7 Series Multipoint Hardware System

Edition 3

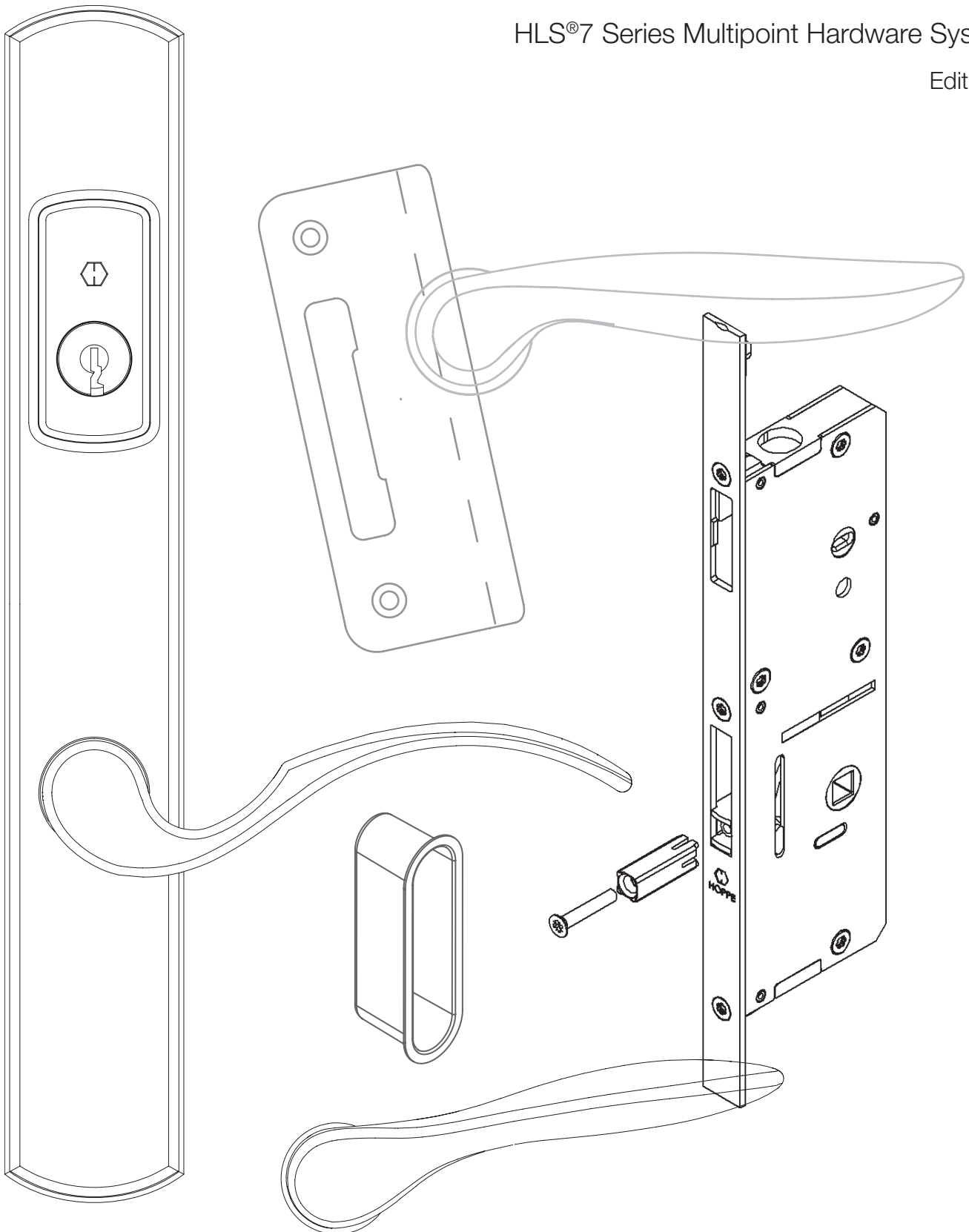

HLS®7 Series Multipoint Hardware System

The next generation of Multipoint Locking Systems from HOPPE North America, Inc.

- Stainless Steel and other non-corrosive components.
- Anti-Back Drive prevents locking points from disengaging from the outside for added security.
- Latch Blocker on inactive systems will not allow multipoint activation until inactive system is activated.
- Lock Out Feature on interior system allows for multipoint activation from the exterior of the door by lifting handle.
- Backset of 45mm (1.77) available.
- Available in the active systems of Shootbolt, Tongue, Swinghook, Swinghook/Shootbolt, Tongue/Shootbolt and the inactive systems of Shootbolt and Rod Lock.
- Available in all current HOPPE Brass handle series and finishes with two new backplate styles.
- Backplate and cylinder housing are forged into one piece for improved appearance and easier installation.
- HOPPE's proprietary Quick-Fit Connection™* handle mounting system allows for the handle to be pushed onto the spindle eliminating set screws for easy installation.
- US style cylinder lock located above the handle.
- Simultaneous retraction feature enables all locking points to be retracted by pushing down on the inside handle.
- Locked or unlocked status of the door can easily be seen from a distance due to 90 degree cylinder operation.



Locked Position



Unlocked Position

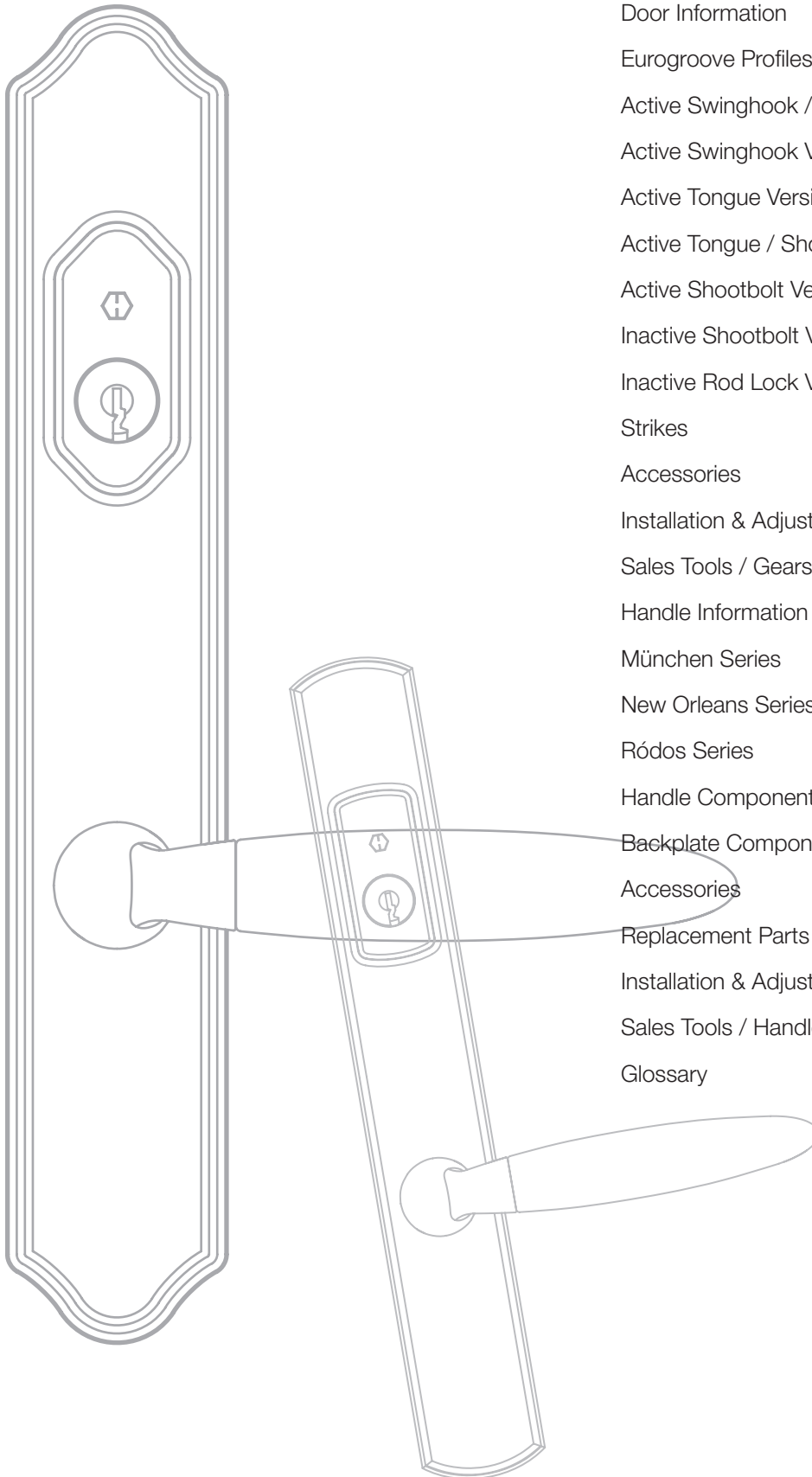

Door Information	Page 4
Eurogroove Profiles	Page 5
Active Swinghook / Shootbolt Version	Page 8
Active Swinghook Version	Page 10
Active Tongue Version	Page 11
Active Tongue / Shootbolt Version	Page 12
Active Shootbolt Version	Page 14
Inactive Shootbolt Version	Page 16
Inactive Rod Lock Version	Page 17
Strikes	Page 18
Accessories	Page 22
Installation & Adjustment / Gears	Page 23
Sales Tools / Gears	Page 28
Handle Information	Page 30
München Series	Page 31
New Orleans Series	Page 33
Ródos Series	Page 34
Handle Components	Page 35
Backplate Components	Page 37
Accessories	Page 39
Replacement Parts	Page 40
Installation & Adjustment / Handles	Page 41
Sales Tools / Handles	Page 45
Glossary	Page 46

Door Information

Gear Version References

An active gear is the primary functioning gear in a door. The active gear must be disengaged first to unlock the door or engaged last in a pair of French doors for locking.

An inactive gear is the secondary functioning gear in a pair of French doors and can only be opened after the “active gear” or primary gear has been activated. The inactive gear makes the secondary door handle operable.

RH is the standard abbreviation for right handed.

LH is the standard abbreviation for left handed.

HLS®7 Series gears are orientated for left or right doors. See handing chart below.

Standard backset of 45mm featured in this catalog.

All information is for reference only and subject to change without notice.

Handing

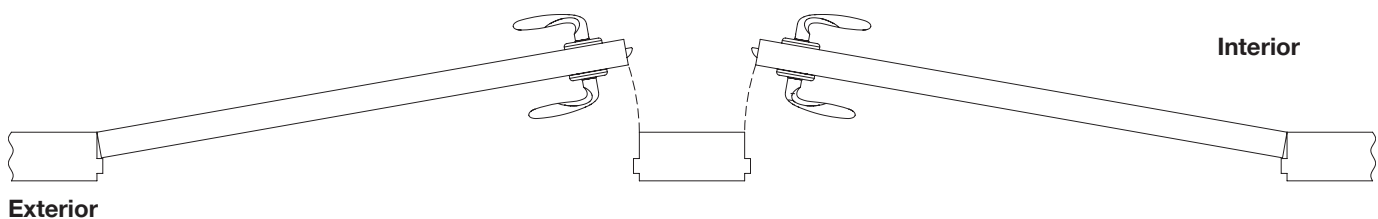

Door handing is always determined from the exterior. When hinges are on the left, the door is LH; when hinges are on the right, door is RH. Inswing or outswing does not determine handing.

Wood

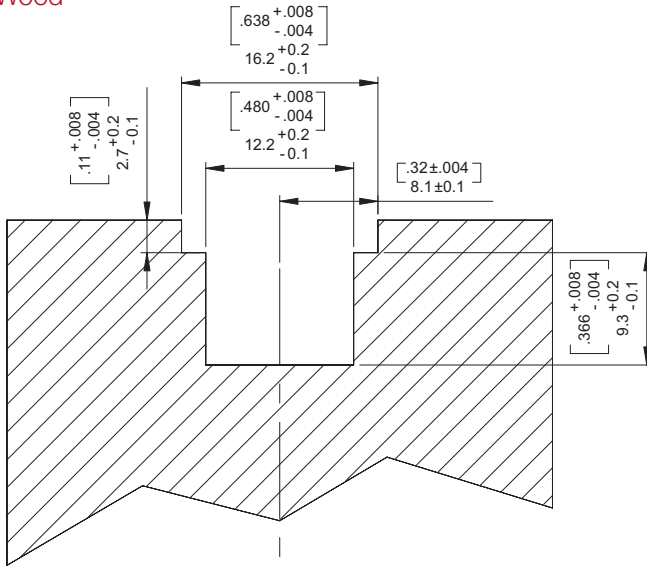

Jig system available for wood.
Contact your local representative.

Generic Profile Shown

Aluminum

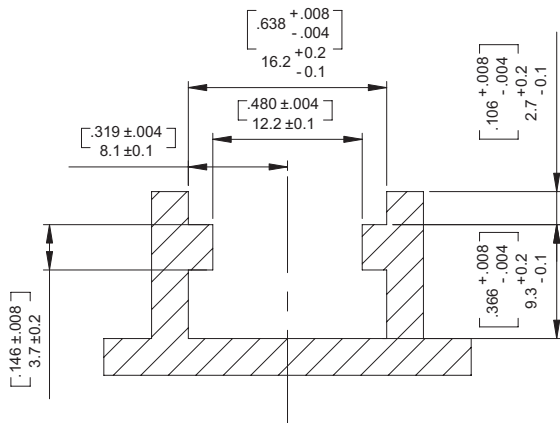

Generic Profile Shown

UPVC

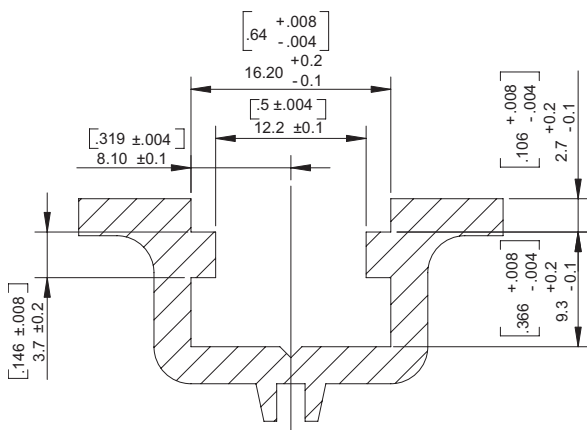

Generic Profile Shown

16mm Eurogroove Profiles

Active & Inactive Gears

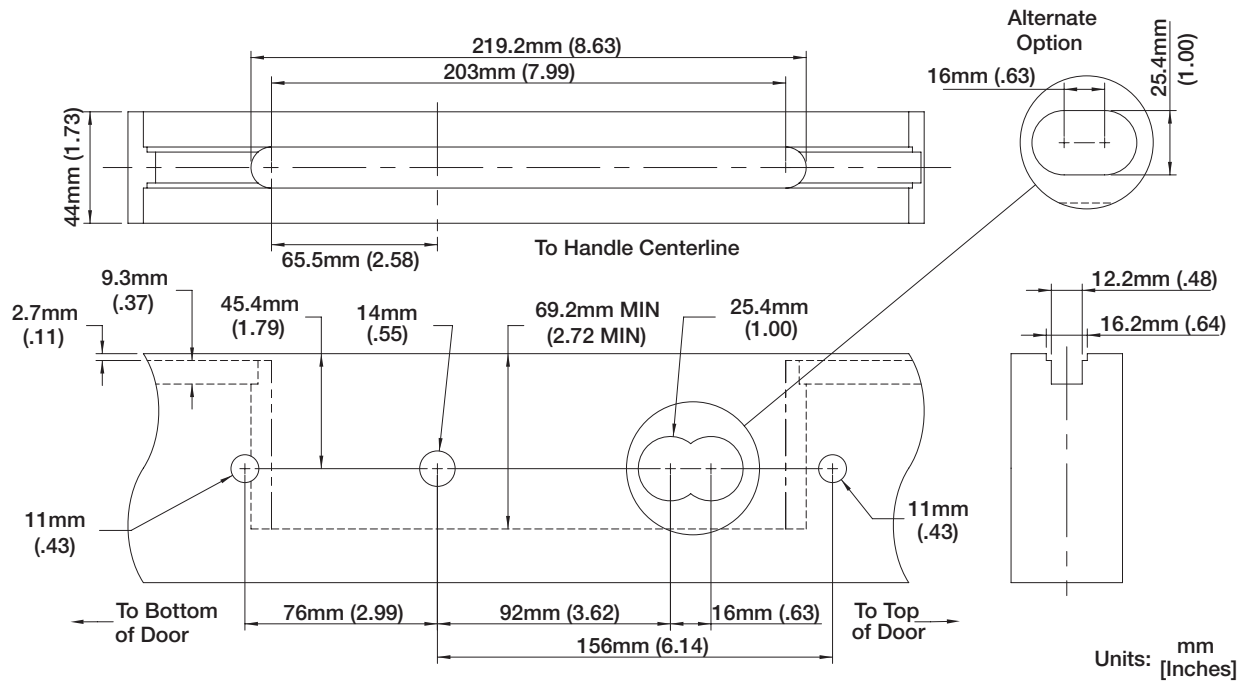

Active Swinghook / Shootbolt - 16mm Faceplate 25mm Shootbolt Throw

ACTIVE SWINGHOOK / SHOOTBOLT VERSION

The Active Swinghook / Shootbolt version offers the highest level of security through the swinghooks which extend the reach into the door frame for added protection against extreme weather conditions. The Shootbolts engage into both the head and sill of the door frame for added confidence and security. The Active Swinghook / Shootbolt version offers the maximum strength both horizontally and vertically.

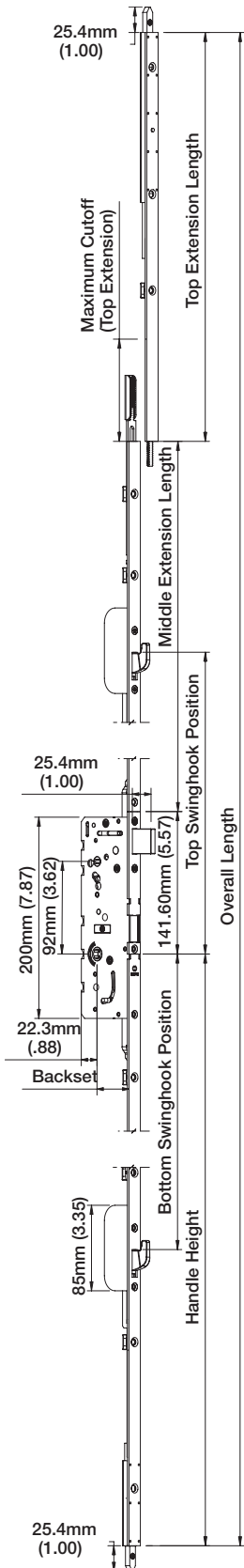
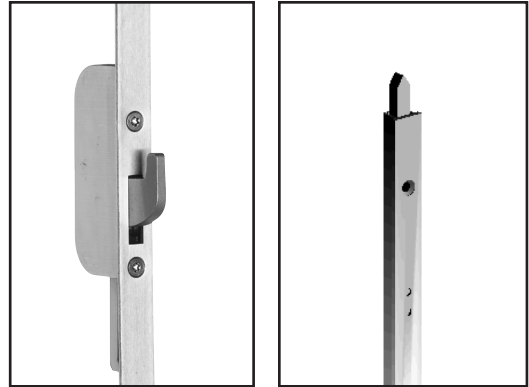

For 6' 8" Door Panel Size with 914mm (36") Handle Height
Top Extension

Part Number	Description	Overall Length	Extension Length	Maximum Cutoff	Number of Screws
2666359	M 558.8 SB 16S 25 101.6	1930.4mm - 2032mm (76.00 - 80.00)	558.8mm (22.00)	101.6mm (4.00)	3

Middle Extension

Item Number	Description	Extension Length	Second Swinghook Position	Maximum Cutoff	Number of Screws
2667343	M 417.2 SW 400 16S	417.2mm (16.43)	400mm (15.75)	N/A	2

For 6' 10" Door Panel Size with 914mm (36") Handle Height

Top Extension

Item Number	Description	Overall Length	Extension Length	Maximum Cutoff	Number of Screws
2665583	M 457.2 SB 16S 25 101.6	2032mm - 2133.6mm (80.00 - 84.00)	457.2mm (18.00)	101.6mm (4.00)	4

Middle Extension

Item Number	Description	Extension Length	Top Swinghook Position	Maximum Cutoff	Number of Screws
2667360	M 620.4 SW 600 16S	620.4mm (24.43)	600mm (23.62)	N/A	3

For 7' 0" Door Panel Size with 914mm (36") Handle Height

Top Extension

Item Number	Description	Overall Length	Extension Length	Maximum Cutoff	Number of Screws
2665583	M 457.2 SB 16S 25 101.6	2032mm - 2133.6mm (80.00 - 84.00)	457.2mm (18.00)	101.6mm (4.00)	4

Middle Extension

Item Number	Description	Extension Length	Top Swinghook Position	Maximum Cutoff	Number of Screws
2667360	M 620.4 SW 600 16S	620.4mm (24.43)	600mm (23.62)	N/A	3

Active Swinghook / Shootbolt - 16mm Faceplate 25mm Shootbolt Throw

For 8' 0" Door Panel Size with 914mm (36") Handle Height

Top Extension

Item Number	Description	Overall Length	Extension Length	Maximum Cutoff	Number of Screws
2666359	M 558.8 SB 16S 25 101.6	1930.4mm - 2032mm (76.00 - 80.00)	558.8mm (22.00")	101.6mm (4.00)	3

Middle Extension

Item Number	Description	Extension Length	Top Swinghook Position	Maximum Cutoff	Number of Screws
2667378	M 823.6 SW 743 16S	823.6mm (32.43)	743mm (29.25)	N/A	4

For 9' 0" Door Panel Size with 914mm (36") Handle Height

Top Extension

Item Number	Description	Overall Length	Extension Length	Maximum Cutoff	Number of Screws
2666367	M 660.4 SB 16S 25 101.6	2946.4mm - 3048mm (116.00 - 120.00)	660.4mm (26.00)	101.6mm (4.00)	4

Middle Extension

Item Number	Description	Extension Length	Top Swinghook Position	Maximum Cutoff	Number of Screws
2671220	M 1026.8 SW 743 16S	1026.8mm (40.43)	743mm (29.25)	N/A	5

Complete system requires a gear, top extension and middle extension. See chart below for gear part numbers.
Part number for gear depends on LH or RH orientation.

Gear

Part Number	Description	Orientation	Backset	Deadbolt Throw	Handle Height	Bottom Locking Position	Maximum Cutoff	Number Of Screws
2666498	M/45/25 914 LI SWS 620 16S 25	LH	45mm (1.77)	25.4mm (1.00)	914mm (36.00)	620mm (24.41)	N/A	5
2716627	M/45/25 914 RE SWS 620 16S 25	RH	45mm (1.77)	25.4mm (1.00)	914mm (36.00)	620mm (24.41)	N/A	5

Active Swinghook Version - 16mm Faceplate

Active Swinghook Version

The Active Swinghook version offers the highest level of security through the swinghooks which extends the reach into the door frame farther than the Active Tongue version. The Active Swinghook pulls the door into the frame for added protection against extreme weather conditions.

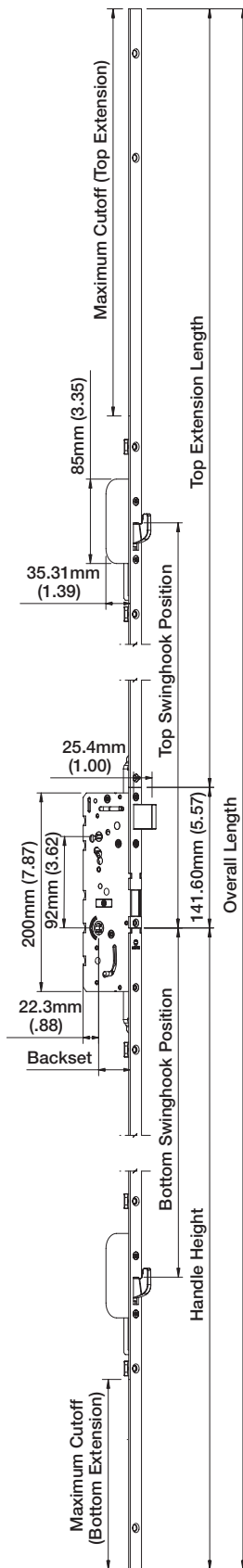
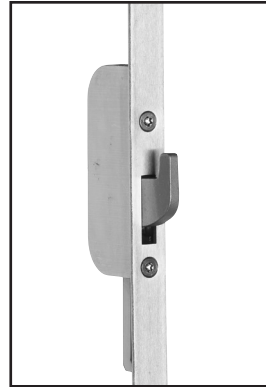

Top Extension

For 6' 8" Door Panel with 914mm (36") Handle Height

Item Number	Description	Overall Length	Extension Length	Top Swinghook Position	Maximum Cutoff	Number of Screws
2663027	M 976 SW 600 16S 410	1622mm - 2032mm (63.86 - 80.00)	976mm (38.43)	600mm (23.62)	410mm (16.14)	3

For 6' 10" & 7' 0" Door Panel with 914mm (36") Handle Height

Item Number	Description	Overall Length	Extension Length	Top Swinghook Position	Maximum Cutoff	Number of Screws
2663035	M 1077.6 SW 743 16S 370	1763.6mm - 2133.6mm (69.43 - 84.00)	1077.6mm (42.43)	743mm (29.25)	370mm (14.57)	4

For 8' 0" Door Panel with 914mm (36") Handle Height

Item Number	Description	Overall Length	Extension Length	Top Swinghook Position	Maximum Cutoff	Number of Screws
2663043	M 1382.4 SW 945 16S 475	1963.4mm - 2438.4mm (77.30 - 96.00)	1382.4mm (54.43)	945mm (37.20)	475mm (18.70)	5

For 9' 0" Door Panel with 914mm (36") Handle Height

Item Number	Description	Overall Length	Extension Length	Top Swinghook Position	Maximum Cutoff	Number of Screws
2663051	M 1687.2 SW 1193 16S 530	2213.2mm - 2743.2mm (87.13 - 108.00)	1687.2mm (66.43)	1193mm (46.97)	530mm (20.87)	6

For 10' 0" Door Panel with 914mm (36") Handle Height

Item Number	Description	Overall Length	Extension Length	Top Swinghook Position	Maximum Cutoff	Number of Screws
2663060	M 1992 SW 1500 16S 530	2518mm - 3048mm (99.13 - 120.00)	1992mm (78.43)	1500mm (59.06)	530mm (20.87)	7

Complete system requires a gear and top extension. See chart below for gear part number. Part number for gear depends on LH or RH orientation.

Gear

Part Number	Description	Orient ation	Backset	Deadbolt Throw	Handle Height	Bottom Swinghook Position	Maximum Cutoff	Number of Screws
2664222	M/45/25 914 LI SW 620 16S	LH	45mm (1.77)	25.4mm (1.00)	914mm (36.00)	620mm (24.41)	187mm (7.36)	5
2664231	M/45/25 914 LI SW 753 16S	LH	45mm (1.77)	25.4mm (1.00)	914mm (36.00)	753mm (29.65)	54mm (2.13)	5
2716635	M/45/25 914 RE SW 620 16S	RH	45mm (1.77)	25.4mm (1.00)	914mm (36.00)	620mm (24.41)	187mm (7.36)	5
2716643	M/45/25 914 RE SW 753 16S	RH	45mm (1.77)	25.4mm (1.00)	914mm (36.00)	753mm (29.65)	54mm (2.13)	5

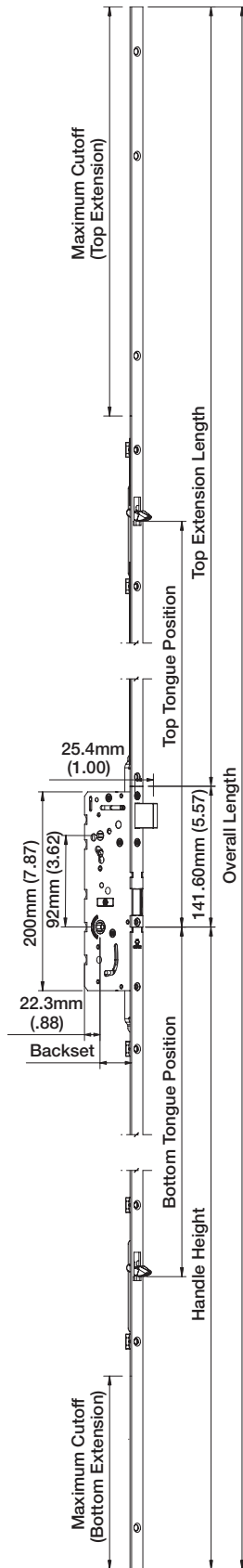

Active Tongue Version

The Active Tongue version retracts into the edge of the door when opened, giving a smooth, clean appearance. The Active Tongue version secures the door in the closed position in two locations by pulling the door into the door frame for additional weather tightness.



Top Extension

For 6' 8" Door Panel with 914mm (36") Handle Height

Item Number	Description	Overall Length	Extension Length	Top Swinghook Position	Maximum Cutoff	Number of Screws
2661056	M 976 TN 600 16S 385	1647mm - 2032mm (64.84 - 80.00)	976mm (38.43)	600mm (23.62)	385mm (15.16)	3

For 6' 10" & 7' 0" Door Panel with 914mm (36") Handle Height

Item Number	Description	Overall Length	Extension Length	Top Swinghook Position	Maximum Cutoff	Number of Screws
2661064	M 1077.6 TN 743 16S 345	1788.6mm - 2133.6mm (70.42 - 84.00)	1077.6mm (42.43)	743mm (29.25)	345mm (13.58)	4

For 8' 0" Door Panel with 914mm (36") Handle Height

Item Number	Description	Overall Length	Extension Length	Top Swinghook Position	Maximum Cutoff	Number of Screws
2661072	M 1382.4 TN 945 16S 445	1993.4mm - 2438.4mm (78.48 - 96.00)	1382.4mm (54.43)	945mm (37.20)	445mm (17.52)	5

For 9' 0" Door Panel with 914mm (36") Handle Height

Item Number	Description	Overall Length	Extension Length	Top Swinghook Position	Maximum Cutoff	Number of Screws
2661081	M 1687.2 TN 1193 16S 505	2238.2mm - 2743.2mm (88.12 - 108.00)	1687.2mm (66.43)	1193mm (46.97)	505mm (19.88)	6

For 10' 0" Door Panel with 914mm (36") Handle Height

Item Number	Description	Overall Length	Extension Length	Top Swinghook Position	Maximum Cutoff	Number of Screws
2661099	M 1992 TN 1500 16S 500	2548mm - 3048mm (100.31 - 120.00)	1992mm (78.43)	1500mm (59.06)	500mm (19.69)	7

Complete system requires a gear and top extension. See chart below for gear part number. Part number for gear depends on LH or RH orientation.

Gear

Part Number	Description	Orient ation	Backset	Deadbolt Throw	Handle Height	Bottom Tongue Position	Maximum Cutoff	Number of Screws
2661101	M/45/25 914 LI TN 620 16S	LH	45mm (1.77)	25.4mm (1.00)	914mm (36.00)	620mm (24.41)	185mm (7.28)	5
2661110	M/45/25 914 LI TN 753 16S	LH	45mm (1.77)	25.4mm (1.00)	914mm (36.00)	753mm (29.65)	52mm (2.05)	6
2716601	M/45/25 914 RE TN 620 16S	RH	45mm (1.77)	25.4mm (1.00)	914mm (36.00)	620mm (24.41)	185mm (7.28)	5
2716619	M/45/25 914 RE TN 753 16S	RH	45mm (1.77)	25.4mm (1.00)	914mm (36.00)	753mm (29.65)	52mm (2.05)	6

Complete system requires a gear and top extension. See chart below for gear part number. Part number for gear depends on LH or RH orientation.

Active Tongue / Shootbolt Version - 16mm Faceplate 25mm Shootbolt Throw

Active Tongue / Shootbolt Version

The Active Tongue / Shootbolt version engages shootbolts into both the head and sill of the door frame as well as two tongues into the frame for added confidence and security. The Active Tongue / Shootbolt version offers exceptional strength both horizontally and vertically against intense weather conditions.

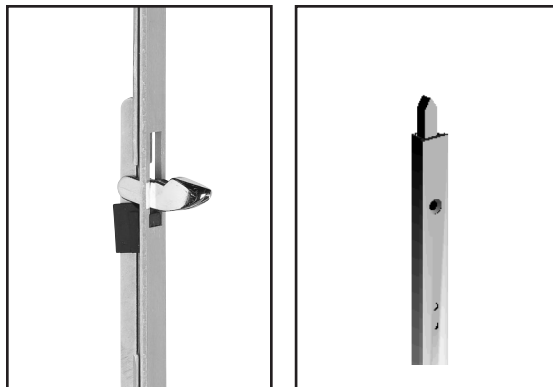

For 6' 8" Door Panel Size with 914mm (36") Handle Height

Top Extension

Item Number	Description	Overall Length Combined with M/0468	Extension Length	Maximum Cutoff	Number of Screws
2666359	M 558.8 SB 16S 25 101.6	1930.4mm - 2032mm (76.00 - 80.00)	558.8mm (22.00)	101.6mm (4.00)	3

Middle Extension

Item Number	Description	Extension Length	Second Tongue Position	Maximum Cutoff	Number of Screws
2666615	M 417.2 TN 400 16S	417.2mm (16.43)	400mm (15.75)	N/A	3

Complete system requires a gear, top extension and middle extension. See next page for gear part numbers. Part number for gear depends on LH or RH orientation.

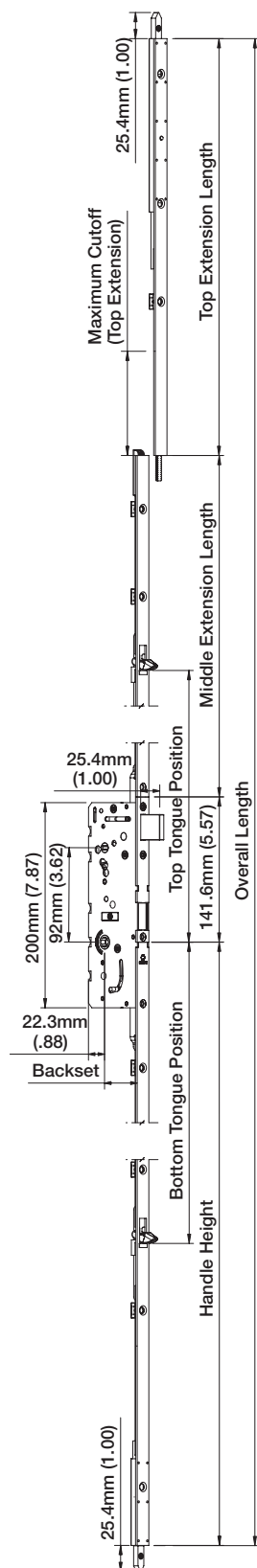

Complete system requires a gear, top extension and middle extension. See next page for gear part numbers. Part number for gear depends on LH or RH orientation.

Active Tongue / Shootbolt Version - 16mm Faceplate 25mm Shootbolt Throw

For 8' 0" Door Panel Size with 914mm (36") Handle Height

Top Extension

Item Number	Description	Overall Length Combined with M/0874.4	Extension Length	Maximum Cutoff	Number of Screws
2666359	M 558.8 SB 16S 25 101.6	2336.8mm - 2438.4mm (92.00 - 96.00)	558.8mm (22.00)	101.6mm (4.00)	3

Middle Extension

Item Number	Description	Extension Length	Second Tongue Position	Maximum Cutoff	Number of Screws
2666631	M 823.6 TN 743 16S	823.6mm (32.43)	743mm (29.25)	N/A	5

Complete system requires a gear, top extension and middle extension. See chart below for gear part numbers.
Part number for gear depends on LH or RH orientation.

Complete system requires a gear, top extension and middle extension. See chart below for gear part numbers.
Part number for gear depends on LH or RH orientation.

Gear

Item Number	Description	Orientation	Backset	Deadbolt Throw	Handle Height	Bottom Locking Position	Maximum Cutoff	Number of Screw Holes
2666480	M/45/25 914 LJ TNS 620 16S 25	LH	45mm (1.77)	25.4mm (1.00)	914.4mm (36.00)	620mm (24.41)	N/A	5
2716651	M/45/25 914 RE TNS 620 16S 25	RH	45mm (1.77)	25.4mm (1.00)	914.4mm (36.00)	620mm (24.41)	N/A	5

Active Shootbolt Version - 16mm Faceplate 25mm Shootbolt Throw

Active Shootbolt Version

The Active Shootbolt version adds vertical strength and security through locking points engaging in the head and sill of the door frame. The Active Shootbolt version provides improved vertical strength and added defense against twisting, warpage and door movement.

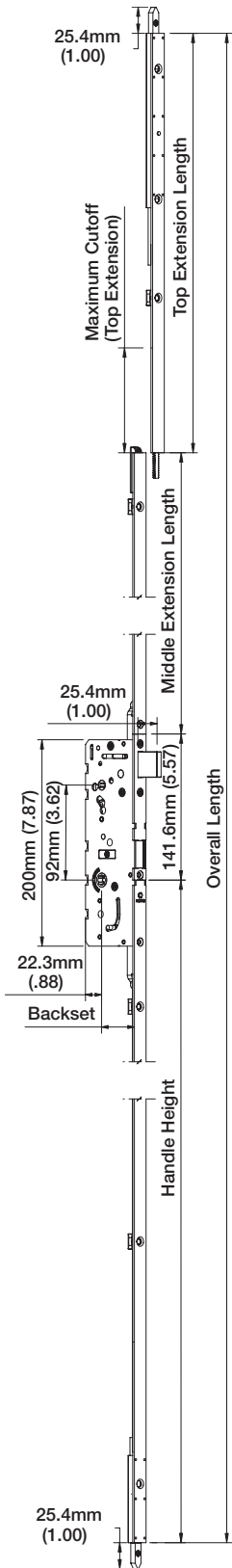
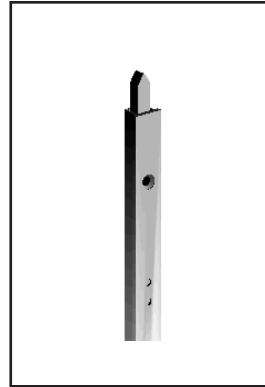

For 6' 8" Door Panel Size with 914mm (36") Handle Height

Top Extension

Item Number	Description	Overall Length Combined with M/0468	Extension Length	Maximum Cutoff	Number of Screws
2666359	M 558.8 SB 16S 25 101.6	1930.4mm - 2032mm (76.00 - 80.00)	558.8mm (22.00)	101.6mm (4.00)	3

Middle Extension

Item Number	Description	Extension Length	Maximum Cutoff	Number of Screws
2665495	M 417.2 16S	417.2mm (16.43)	N/A	2

Complete system requires a gear, top extension and middle extension. See next page for gear part numbers. Part number for gear depends on LH or RH orientation.

For 6' 10" Door Panel Size with 914mm (36") Handle Height

Top Extension

Item Number	Description	Overall Length Combined with M/0468	Extension Length	Maximum Cutoff	Number of Screws
2665583	M 457.2 SB 16S 25 101.6	2032mm - 2133.6mm (80.00 - 84.00)	457.2mm (18.00)	101.6mm (4.00)	4

Middle Extension

Item Number	Description	Extension Length	Maximum Cutoff	Number Of Screws
2665508	M 620.4 16S	620.4mm (24.43)	N/A	2

Complete system requires a gear, top extension and middle extension. See next page for gear part numbers. Part number for gear depends on LH or RH orientation.

For 7' 0" Door Panel Size with 914mm (36") Handle Height

Top Extension

Item Number	Description	Overall Length Combined with M/0468	Extension Length	Maximum Cutoff	Number of Screws
2665583	M 457.2 SB 16S 25 101.6	2032mm - 2133.6mm (80.00 - 84.00)	457.2mm (18.00)	101.6mm (4.00)	4

Middle Extension

Item Number	Description	Extension Length	Maximum Cutoff	Number Of Screws
2665508	M 620.4 16S	620.4mm (24.43)	N/A	2

Complete system requires a gear, top extension and middle extension. See next page for gear part numbers. Part number for gear depends on LH or RH orientation.

Active Shootbolt Version - 16mm Faceplate 25mm Shootbolt Throw

For 8' 0" Door Panel Size with 914mm (36") Handle Height

Top Extension

Item Number	Description	Overall Length Combined with M/0874.4	Extension Length	Maximum Cutoff	Number of Screws
2666359	M 558.8 SB 16S 25 101.6	2336.8mm - 2438.4mm (92.00 - 96.00)	558.8mm (22.00)	101.6mm (4.00)	3

Middle Extension

Item Number	Description	Extension Length	Maximum Cutoff	Number of Screws
2665516	M 823.6 16S	823.6mm (32.43)	N/A	4

Complete system requires a gear, top extension and middle extension. See chart below for gear part numbers.
Part number for gear depends on LH or RH orientation.

For 9' 0" Door Panel Size with 914mm (36") Handle Height

Top Extension

Item Number	Description	Overall Length Combined with M/1077.6	Extension Length	Maximum Cutoff	Number of Screws
2666367	M 660.4 SB 16S 25 101.6	2641.6mm - 2743.2mm (104.00 - 108.00)	660.4mm (26.00)	101.6mm (4.00)	4

Middle Extension

Item Number	Description	Extension Length	Maximum Cutoff	Number of Screws
2665575	M 1026.8 16S	1026.8mm (40.43)	N/A	5

Complete system requires a gear, top extension and middle extension. See chart below for gear part numbers.
Part number for gear depends on LH or RH orientation.

For 10' 0" Door Panel Size with 914mm (36") Handle Height

Top Extension

Item Number	Description	Overall Length	Extension Length	Maximum Cutoff	Number of Screws
2666367	M 660.4 SB 16S 25 101.6	2946.4mm - 3048mm (116.00 - 120.00)	660.4mm (26.00)	101.6mm (4.00)	4

Middle Extension

Item Number	Description	Extension Length	Maximum Cutoff	Number of Screws
2665524	M 1331.6 16S	1331.6mm (52.43)	N/A	6

Complete system requires a gear, top extension and middle extension. See chart below for gear part numbers.
Part number for gear depends on LH or RH orientation.

Gear

Item Number	Description	Orientation	Backset	Deadbolt Throw	Handle Height	Maximum Cutoff	Number of Screws
2664214	M/45/25 914 LI SB 16S 25	LH	45mm (1.77)	25.4mm (1.00)	914.4mm (36.00)	N/A	4
2717179	M/45/25 914 RE SB 16S 25	RH	45mm (1.77)	25.4mm (1.00)	914.4mm (36.00)	N/A	4

Inactive Shootbolt - 16mm Faceplate 25mm Shootbolt Throw

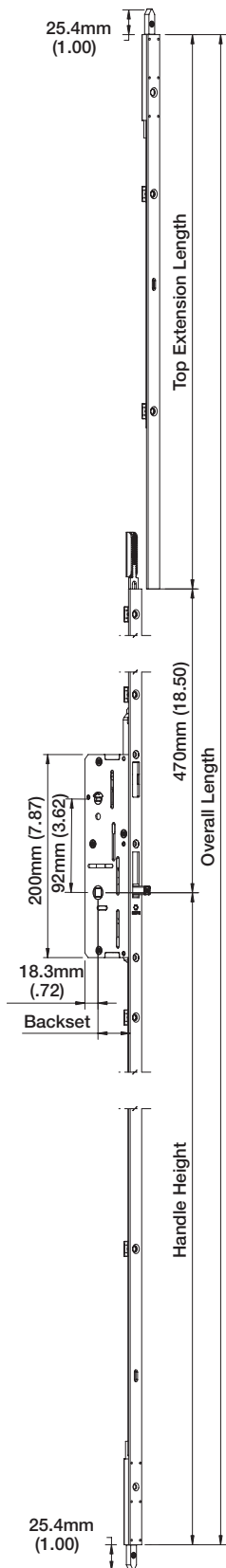

Inactive Shootbolt Version

The Inactive Shootbolt version offers security on the secondary panel through the handle-operated shootbolt throw, engaging in the head and sill of the door frame. The Inactive Shootbolt version not only adds vertical strength to the door but the added beauty of operable handles on French doors.



Top Extension

For 6' 8" Door Panel with 914mm (36") Handle Height

Item Number	Description	Overall Length	Extension Length	Maximum Cutoff	Number of Screws
2665241	IA 0647.6 SB 16S 25	1930.4mm - 2032mm (76.00 - 80.00)	647.6mm (25.50)	101.6mm (4.00)	3

For 6' 10" & 7' 0" Door Panel with 914mm (36") Handle Height

Item Number	Description	Overall Length	Extension Length	Maximum Cutoff	Number of Screws
2665250	IA 0749.2 SB 16S 25	2032mm - 2133.6mm (80.00 - 84.00)	749.2mm (29.50)	101.6mm (4.00)	3

For 8' 0" Door Panel with 914mm (36") Handle Height

Item Number	Description	Overall Length	Extension Length	Maximum Cutoff	Number of Screws
2665284	IA 1054 SB 16S 25	2336.8mm - 2438.4mm (92.00 - 96.00)	1054mm (41.50)	101.6mm (4.00)	4

Complete system requires a gear and top extension. See chart below for gear part number.

Gear

Item Number	Description	Backset	Latch Blocker Length	Handle Height	Maximum Cutoff	Number of Screws
2665356	IA/45 914 SB 16S 25	45mm (1.77)	N/A	914.4mm (36.00)	N/A	6
2665364	IA/45 914 27.5 SB 16S 25	45mm (1.77)	27.5mm	914.4mm (36.00)	N/A	6
2665399	IA/45 914 37.5 SB 16S 25	45mm (1.77)	37.5mm	914.4mm (36.00)	N/A	6

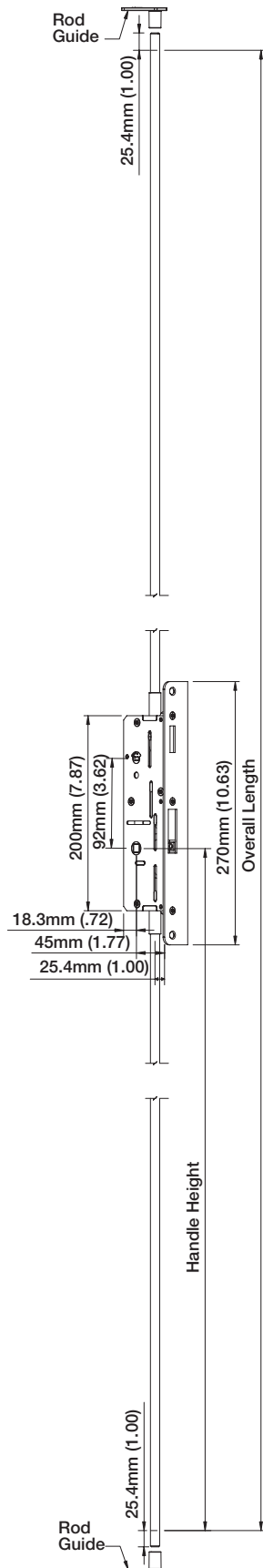

Inactive Rod Lock Version

The Inactive Rod Lock version can be used when there is no astragal between the door panels of a French door or used with an astragal to conceal the faceplate. The handle-operated Inactive Rod Lock secures the door at the head and sill of the door frame while allowing the active lock to engage into the inactive panel.



8mm Rods with 8mm threads

Part Number	Description	Rod Length
8786895	BK/SS/08/08/0599.6/B	8mm x 599.6mm (.31 X 23.61)
8779363	BK/SS/08/08/0972/B	8mm x 972mm (.31 X 38.27)
8779367	BK/SS/08/08/1035.5/B	8mm x 1035.5mm (.31 X 40.77)
8786907	BK/SS/08/08/1188.6/B	8mm x 1188.6mm (.31 X 46.79)
8779379	BK/SS/08/08/1695.9/B	8mm x 1695.9mm (.31 X 66.77)

9.5mm Rods with 8mm threads

Part Number	Description	Rod Length
8789539	BK/SS/9.5/08/0676/B	9.5mm x 676mm (.37 X 24.33)
8789547	BK/SS/9.5/08/1005/B	9.5mm x 1005mm (.37 X 39.57)
8786855	BK/SS/9.5/08/1038.7/B	9.5mm x 1038.7mm (.37 X 40.89)
8789551	BK/SS/9.5/08/1183/B	9.5mm x 1183mm (.37 X 46.57)
8786863	BK/SS/9.5/08/1394.3/B	9.5mm x 1394.3mm (.37 X 54.89)
8786867	BK/SS/9.5/08/1699.1/B	9.5mm x 1699.1mm (.37 X 66.71)
8786871	BK/SS/9.5/08/2003.9/B	9.5mm x 2003.9mm (.37 X 78.89)

Handle Actuated Gear with Faceplate*

Part Number	Description	Backset	Orientation	Number Of Screws
2661013	IA/45 16S 25	45mm (1.77)	LH	2
2661030	IA/45 16S 25	45mm (1.77)	RH	2

See page 19 for Rod Guides.

Notes:

1. The 8mm rods have 25.4mm of thread but only thread into this lock 10mm.
2. To reduce the throw of the rod, cut rod so that it pulls back into the door.

Strikes

Latch and Deadbolt Strikes

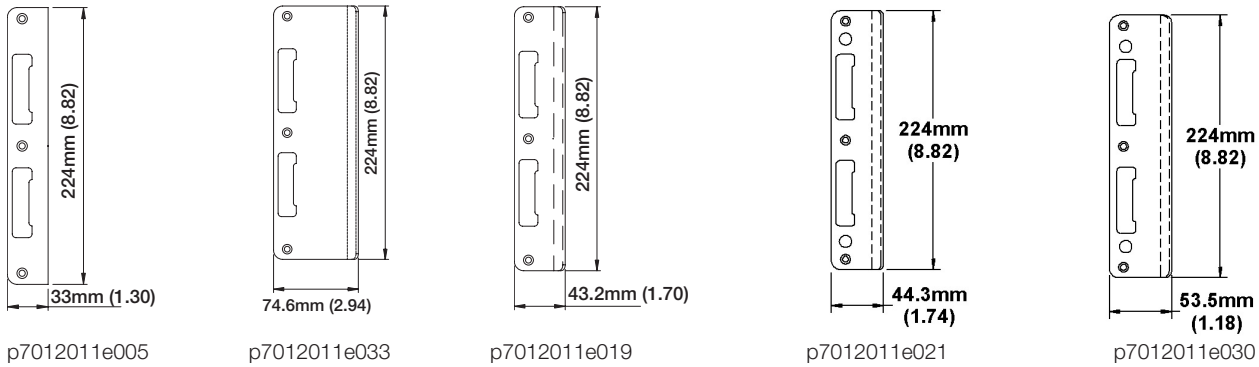

Latch and Deadbolt Strike - Flat & Non Handed

	Brass	Stainless Steel	Rustic Umber (F8709)
p7012011e005	2342194	2342311	2621821

NOTE: Rebated vinyl profile strikes are profile specific. Contact your representative for specific profiles required.

Latch and Deadbolt Strike - Extended Curved Lip & Non Handed

	Brass	Stainless Steel	Rustic Umber (F8709)
p7012011e033	3879701	8787743	2829867

Latch and Deadbolt Strike - Curved Lip & Non Handed

	Brass	Stainless Steel	Rustic Umber (F8709)
p7012011e019	1963546	1963554	2162880

Strike Extender - Curved Lip & Non Handed

	Stainless Steel
p7012011e080	1972477

Latch and Deadbolt Strike - Curved Lip with Inactive Cylinder Hole & Non Handed Contains access hole for reaching the cylinder screw on inactive panel

	Brass	Stainless Steel	Matte Black (F9714)	Satin Nickel (F42)	Rustic Umber (F8709)
p7012011e021	8787715	8787747	8787735	2127443	2616554

Latch and Deadbolt Strike - extended curved lip, non handed For centered 2-1/4" panels

	Brass	Stainless Steel	Rustic Umber (F8709)
p7012011e030	2014019	2014027	3772612

Extender for use with Latch & Deadbolt - Curved Lip & Non Handed

	Stainless Steel
p7012011e080	1972477

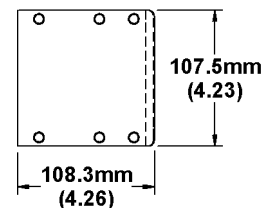

p7012011e080

Tongue Strikes

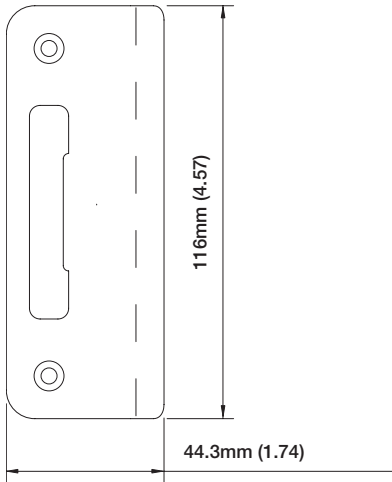

p7012008E009

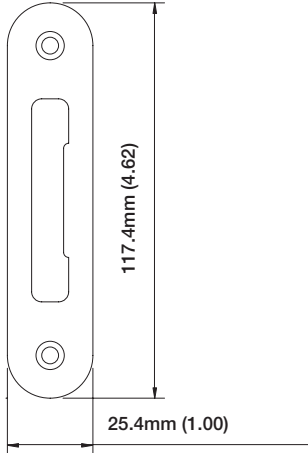

p7012008e011

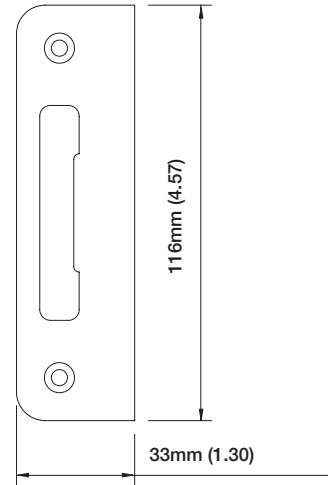

p7012008e007

Tongue Strike - Curved Lip

	Brass	Stainless Steel	Rustic Umber (F8709)
p7012008E009	8784675	1964522	2163006

Tongue Strike - Radius Lip

	Brass	Stainless Steel	Rustic Umber (F8709)
p7012008e011	2025181	2025199	2671238

Tongue Strike - Flat

	Brass	Stainless Steel	Brushed Chrome (F41)	Matte Black (F9714)	Satin Nickel (F42)	Rustic Umber (F8709)
p7012008e007	8784699	8784707	8786559	8786575	2127486	2245597

Swing Bolt Strikes

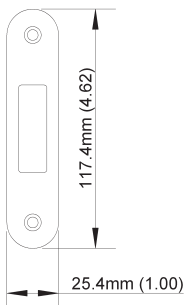

p70120014e001

Swing Bolt Strikes - Flat

	Stainless Steel
p7012014e001	2736661

Strikes

Double Door Strikes

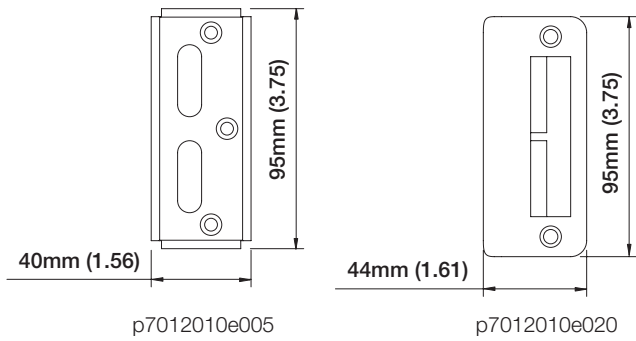

Double Shootbolt Strike

	Brass	Stainless Steel
p7012010e005	N/A	8752847
p7012010e020	8789023	8789027

High Performance Cover Plate

	Stainless Steel
p7012016e001	2512296

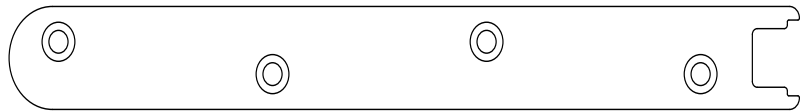

Rod Guides

Rod Guide

	Standard 8mm	Standard 9.9mm
Black	1900916	1900908

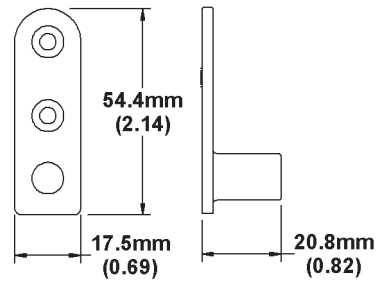

Standard

Shootbolt Strikes

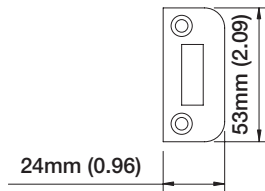

p7012010e057

Shootbolt Strike - For Single Door

	Brass	Stainless Steel
p7012010e057	2016559	2058724

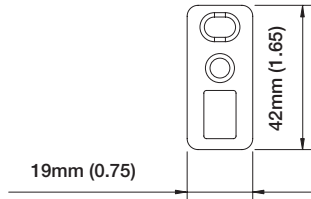

p7012010e032

Shootbolt Strike - For Single Door

	Brass	Stainless Steel
p7012010e032	2135259	2098911

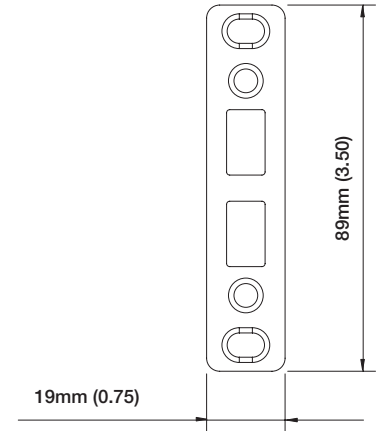

p7012010e007

Shootbolt Strike - For Double Door

	Stainless Steel
p7012010e007	2098945

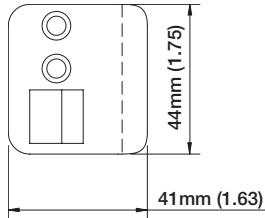

p7012010e037

Shootbolt Strike - Left Handed for Single Door / Curved Lip

	Brass	Stainless Steel
p7012010e037	8784095	8784091

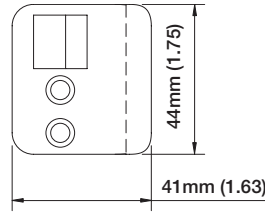

p7012010e038

Shootbolt Strike - Right Handed for Single Door / Curved Lip

	Brass	Stainless Steel
p7012010e038	8784067	8783923

Socket Strikes

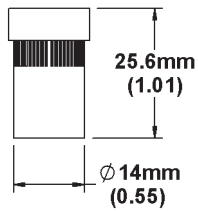

p7012018e001

Socket Strike - 1" Throw

	Brass
p7012018e001	2024962

Accessories

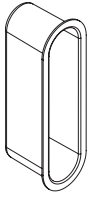

Dust Cap

	Part Number	Finish
For Latch & Deadbolt Strike or Tongue Strike	8786547	Black

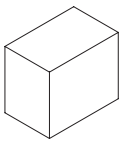

Foam Eurogroove Plug

	Part Number	Finish
For behind the faceplate	1963538	Black

Screws

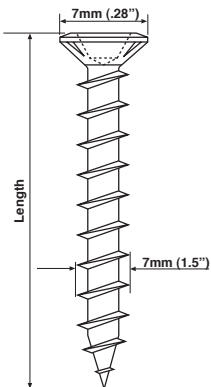

Screws for Vinyl Profiles

Part Number	Description	Length	Quantity Per Box
8785667	Stainless Steel Screw - 7mm Head Size	19mm (0.75)	1000
11756415	Stainless Steel Screw - 7mm Head Size	25mm (1.00)	1000
11756421	Stainless Steel Screw - 7mm Head Size	35mm (1.38)	1000

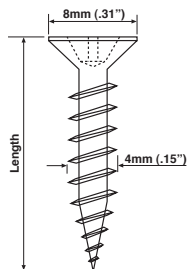

Screws for Wood Profiles

Part Number	Description	Length	Quantity Per Box
8785687	Stainless Steel Screws - 8mm Head Size	20mm (0.79)	1000
8785691	Stainless Steel Screws - 8mm Head Size	30mm (1.18)	1000
8785695	Stainless Steel Screws - 8mm Head Size	35mm (1.38)	1000
8785699	Stainless Steel Screws - 8mm Head Size	45mm (1.77)	500
8785703	Stainless Steel Screws - 8mm Head Size	60mm (2.36)	500

HL®7 Series Identifying & Reversing Gear Handing

IMPORTANT NOTE: Due to the Anti-Panic feature, this lock must be properly oriented to interior/ exterior of door, in order for it to function properly.

Locate screw positions A, B, Y and Z on sides of lockcase. Using the graphic below, determine interior/exterior side and right/left hand by determining which two locations contain a screw.

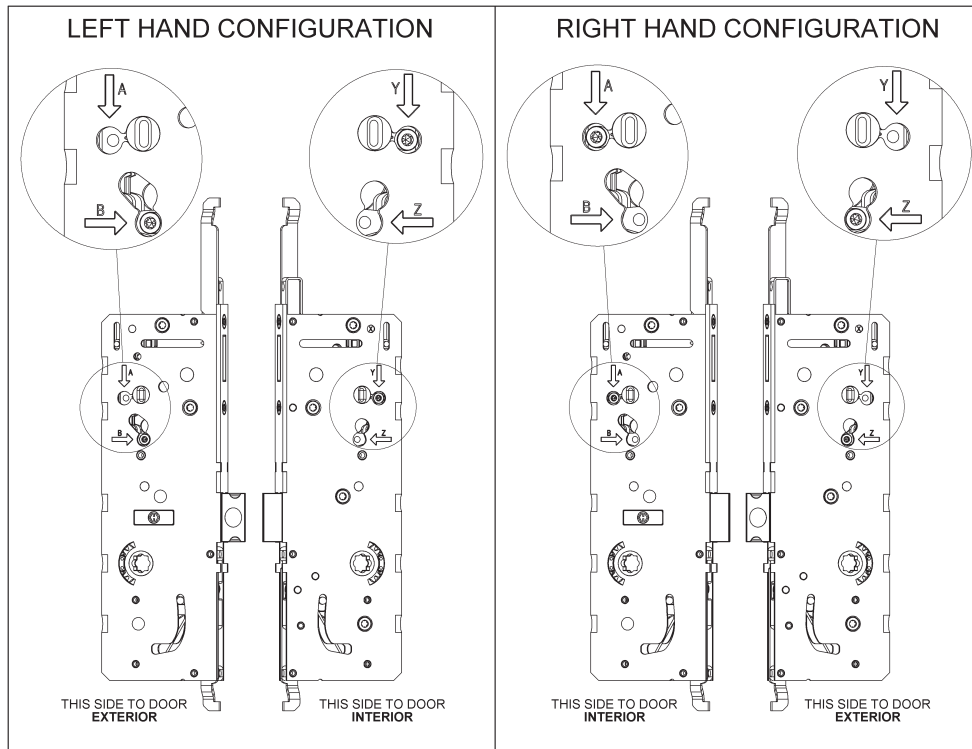

To Reverse Handing of Gear:

IMPORTANT: USE ONLY A HAND SCREWDRIVER – NOT A POWER DRIVER

1. Locate screw positions A, B, Y and Z on sides of lockcase, and switch the locations of the screws according to the chart below.
2. To reverse latch, pull straight out and rotate 180°.

Handing Change	Remove From	Install Into
From Right Hand to Left Hand	A & Z	B & Y
From Left Hand to Right Hand	B & Y	A & Z

If both screws are installed in same side of lockcase, the gear will not function properly.

HLS®7 Series Multipoint Locking Hardware Installation Instructions

1. Slide main gear into place aligning lockcase with pre-drilled handle holes or bottom of the door. Check to make sure the gear does not extend past the bottom of the door.
2. Slide top extension into place and fasten to door with a installation screw. Check again to make sure the gear does not extend past the bottom of the door.
3. Install backplates with mounting screws and hand tighten. See Handle Set Installation Instruction sheet on page 50.

NOTE:

Main gear and extensions should be hand tightened only.

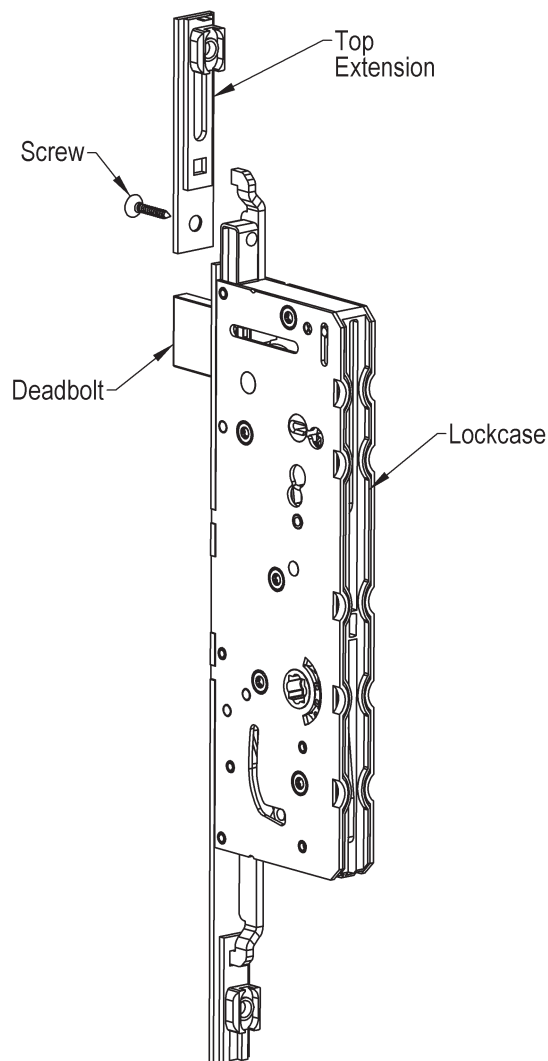

HLS®7 Series System Terminology

1. Trim Maintenance:
Use water and a soft cloth to clean. Do not use brass cleaner as it will remove the protective coating.
2. Note: All options are shown for the sake of terminology. The gear system you have will NOT contain all the components as shown in the diagram below.

Terminology:

1. Top Shootbolt
2. Bottom Shootbolt
3. Deadbolt
4. Latch
5. Cylinder Tail Piece Hole
6. Handle Hole
7. Lockcase
8. Drive Rail
9. Faceplate
10. Screw Support
11. Tongue
12. Swinghook

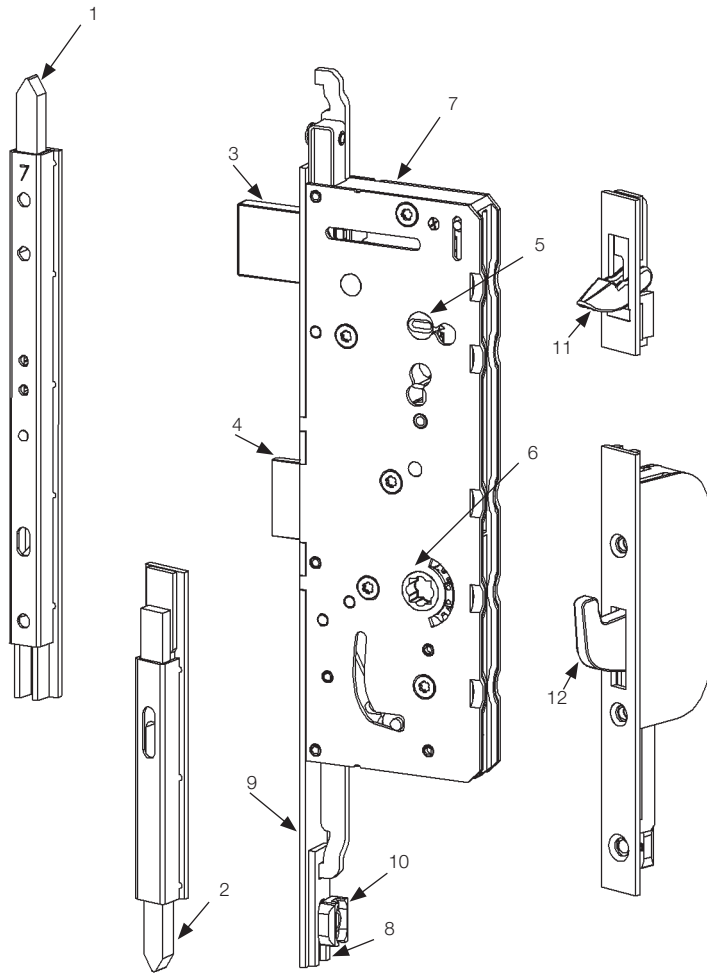

HLS®7 Series Inactive Gear Latch Blocker Instructions

The Latch Blocker is a design feature of the HLS®7 Series multipoint gear system which enables the operational timing/sequencing between the active and inactive gears. The function of the Latch Blocker is to prevent the latch of the active system from engaging into the strike until the inactive system is activated. Once the inactive system is activated, the Latch Blocker moves out of the way enabling the latch to engage into the strike. The multipoint can then be activated.

For an inactive gear system featuring the Latch Blocker, the Latch Blocker is adjustable to provide increased length. Make this adjustment when the Latch Blocker is not providing adequate functionality. The Latch Blocker is factory installed in a recessed position. To increase the length, follow these steps:

1. Remove the Phillips head screw.
2. Rotate the Latch Blocker 90° in either direction after extracting it from the gear.
3. Re-insert the Latch Blocker.
4. Re-install the Phillips head screws. Do not over-tighten the screw.

The length adjustment is approx. 1/16". If further length is required, select the next Latch Blocker length.

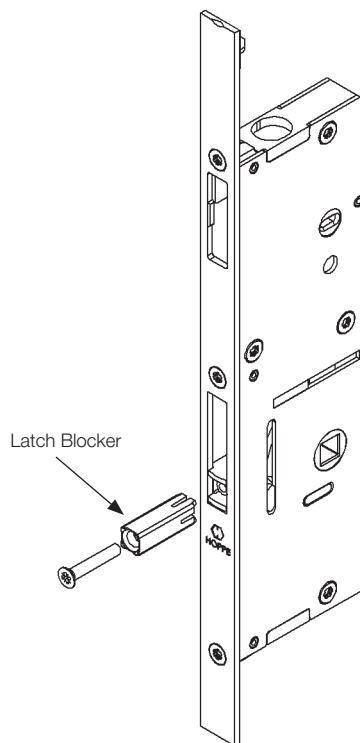

HLS®7 Series Inactive Assembly Instructions

We recommend assembly of the inactive gear in the activated (locked) position. To be consistent in the operation and assembly, you should assemble the gear operator as follows:

Install main gear body assembly into stile using either method:

- a. If using a jig to center the gear on the handle hole, slide into place and screw down.
 - b. If aligning the gear from the bottom, match the bottom of the gear to the bottom of the door and put a few screws in place.
1. Operate and extend the shootbolt mechanism with the handle.
 2. Pull and/or push shootbolt out and place top extension into Eurogroove so the serrations on the extension connect to the gear serrations.
 3. Finish screwing the inactive system onto the stile. Be sure you install screws only in the holes that will not be filled when the astragal is applied.
 4. Operate the thumbturn and handle set to retract and extend the shootbolts. The shootbolt mechanisms should operate freely.
 5. The inactive gear is a two-handed operation. Turn and hold the thumbturn while depressing the handle to retract the shootbolts. Lift the handle to extend the shootbolts. The shootbolt mechanism should operate freely.

Note: There is an allowance of up to 1/8" (3mm) between the gear and extension as long as the driverail and faceplate relationship is kept intact.

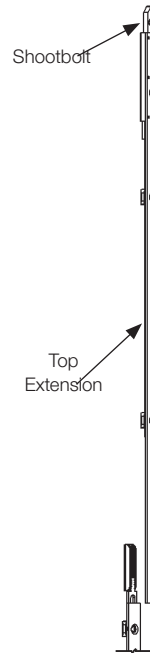

Sales Tools

Part Number	Backset	Locking Type
2836565	45mm (1.79")	Active Multi-Function
2836557	45mm (1.79")	Inactive
2836573	45mm (1.79")	Rod-Lock

Multi-function version shown includes tongue, shootbolt and swinghook functions. Active and Inactive include gear, mount and sales case.

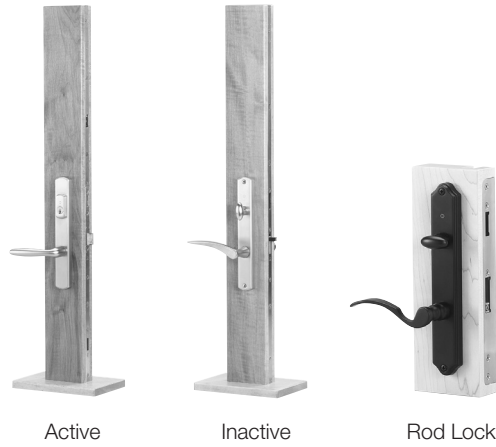

Black Sales Case

Part Number	Description
2824783	Telescoping Handle & Wheeled 38 x 9 x 10

Handle set is specified by customer.

For more details on obtaining sales tools above, contact your local representative.



Part Number	Description
2824783	Telescoping Handle & Wheeled 38 X 9 X 10

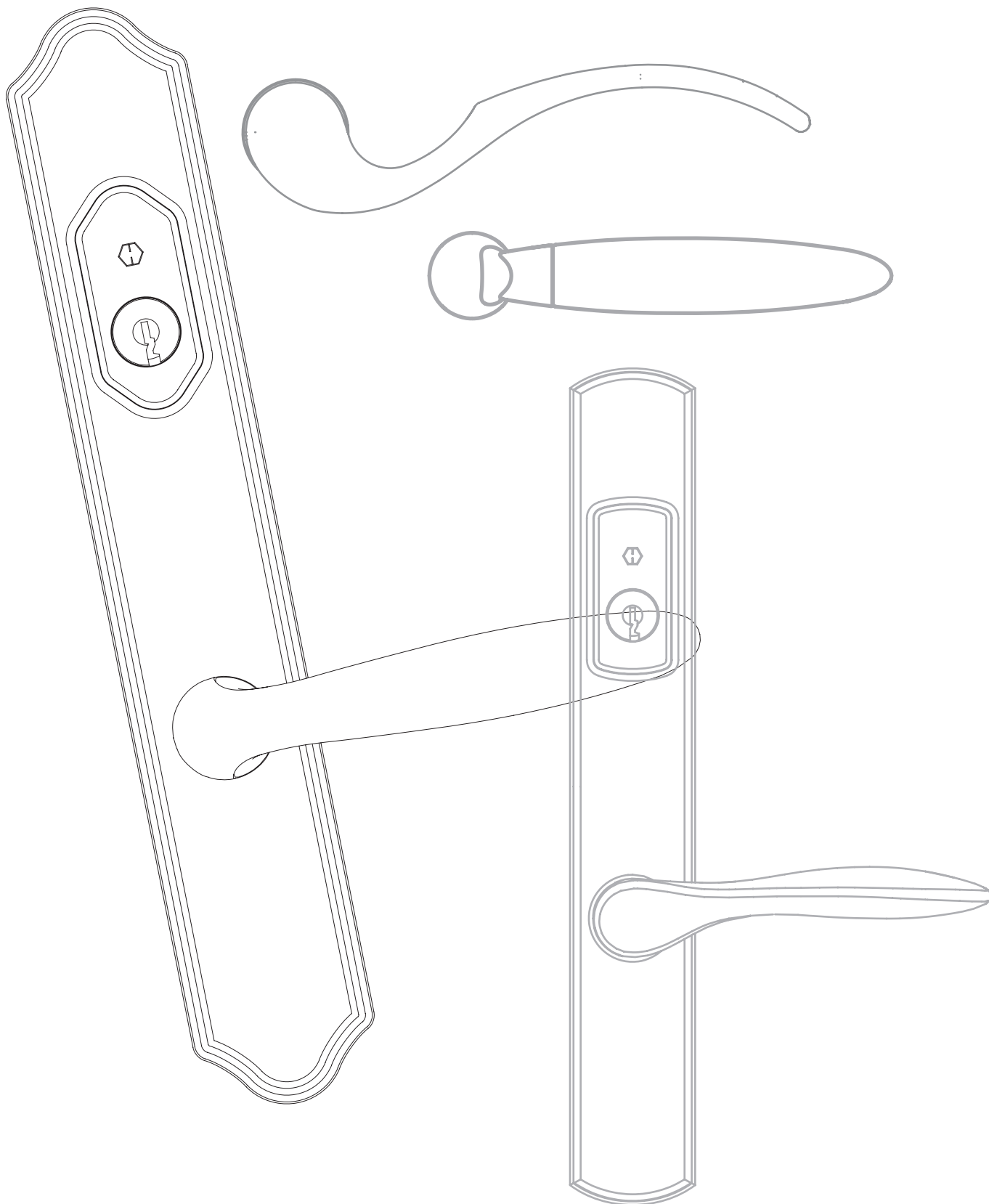

HOPPE's Proprietary Quick-Fit Connection

Handle sets for the HLS®7 range of multipoint locks feature the HOPPE quick-fit connection. The HOPPE quick-fit technology allows the handle to be firmly and quickly fixed to the spindle simply by putting these two pieces together. This means no set screws, no tools and no hassle. Installation time and effort are reduced – another benefit of the HLS®7 line of products. Disengaging the quick-fit connection is simple and fast. Insert the release tool (provided) into the handle near the neck. Use a small (0.100"), flathead screwdriver if the HOPPE release tool is not available. Rotate and hold the release tool while pulling the handle. The handle will slide off of the spindle. Remove the release tool before re-installing the handle.

Handle Set References

An **active door set** is the handle set used on the primary functioning door. The set will always have a cylinder on the outside backplate and a thumbturn on the interior backplate.

An **inactive door set** is the handle set used on the inactive panel. This set will have only a thumb turn on the interior backplate.

A **pair fixed dummy** is a handle set which is usually "fixed" in place by a fixing nut. They serve only as pull handles and do not operate.

An **active or inactive interior** backplate contains a thumb turn for activating the deadbolt.

An **active exterior** backplate contains a cylinder hole.

An **inactive exterior** backplate contains no cylinder hole.

RH is the standard abbreviation for right handed. See handing chart below.

LH is the standard abbreviation for left handed. See handing chart below.

Non-Handed means that the handle can be used for either a right or left handed door.

Resista® - The HOPPE Surface Guarantee

HOPPE's Resista® program of finishes is available on selected solid brass handle sets and protects against tarnishing, peeling and cracking. All Resista® finishes are indicated by an "R" after the handle color code and are covered by our Resista® Finish Limited Lifetime Warranty which is explained on page 57.

It is important to remember to use water and a soft cloth to clean brass. Do not use brass cleaner, detergents or chemical cleansers as they may remove the protective coating.

Handing

Resista®
Limited Lifetime Finish Warranty

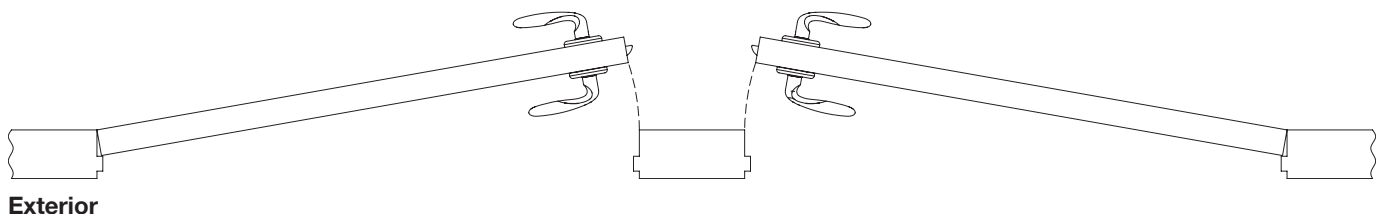

Door handing is always determined from the exterior. When hinges are on the left, the door is LH; when hinges are on the right, door is RH. Inswing or outswing does not determine handing.

München
Solid Brass
M112P/2167N

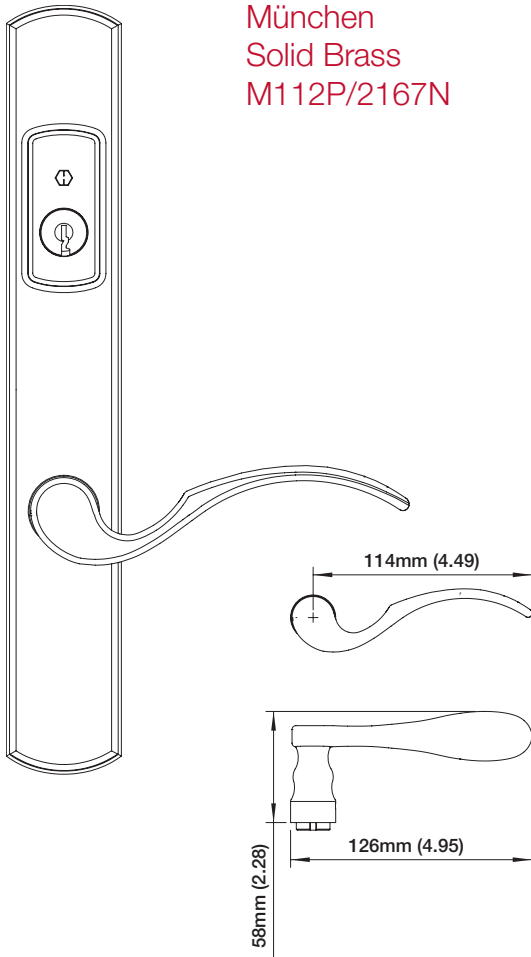

Right Hand Shown

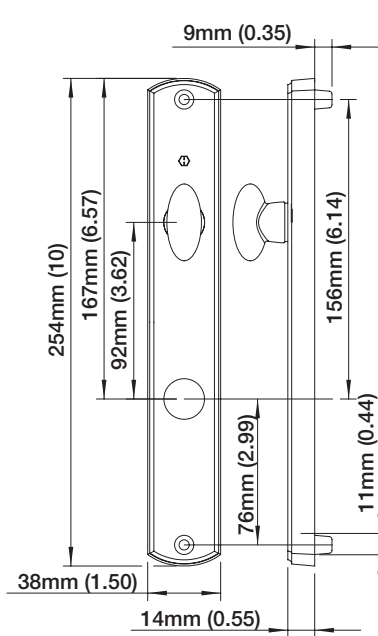

Interior Backplate

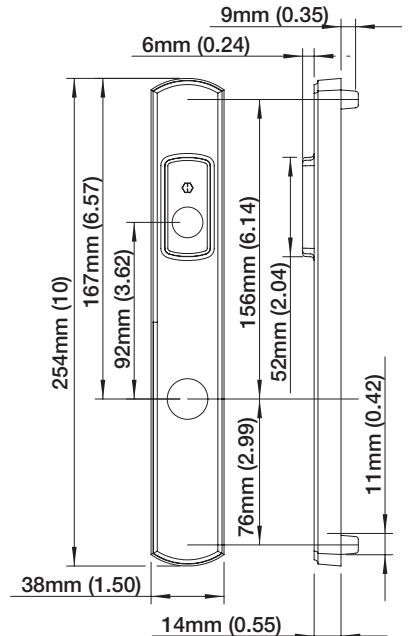

Exterior Backplate

	Brass Resista® (F77-R)	Oil- Rubbed Brass (F79)	Rustic Umber (F8709)
Active Door Set	2740627	2744089	2744151
Inactive Door Set	2749197	2749226	2749285
Dummy Handle Set		2751713	

Active Door Sets have a cylinder on the outside backplate and a thumbturn on the interior backplate.
Inactive Door Sets have only the thumbturn on the interior plate.
Pair Fixed Dummy Sets do not operate.

München
Solid Brass
M112P/2172N

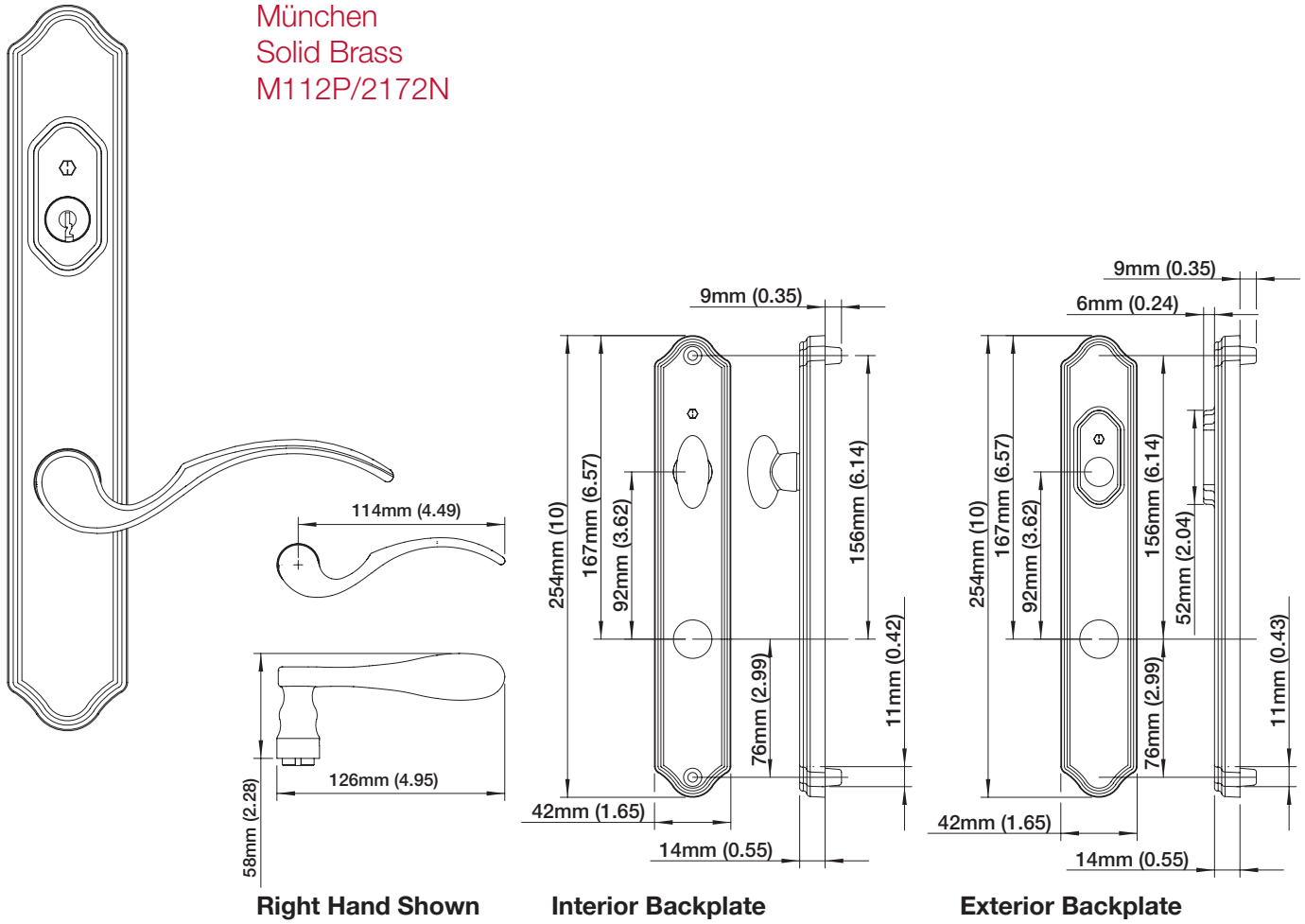

Right Hand Shown

Interior Backplate

Exterior Backplate

	Satin
Model: M112P/2172N	Nickel
Material: Solid Brass	Resista® (F42-R)
Active Handle sets	2745911
Inactive Handle sets	2749883
Dummy Handle sets	2752476

Active Door Sets have a cylinder on the outside backplate and a thumbturn on the interior backplate.
Inactive Door Sets have only the thumbturn on the interior plate.
Pair Fixed Dummy Sets do not operate.

New Orleans
Solid Brass
M1610/2167N

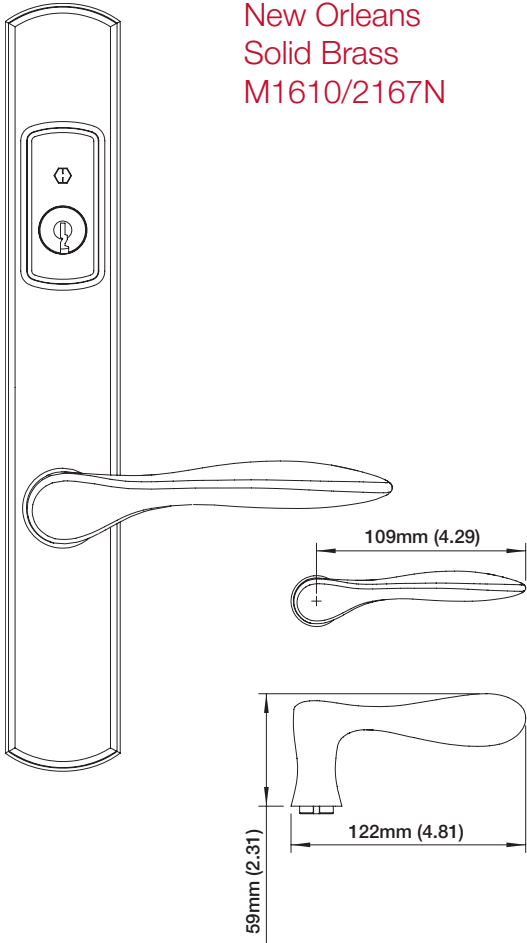

Right Hand Shown

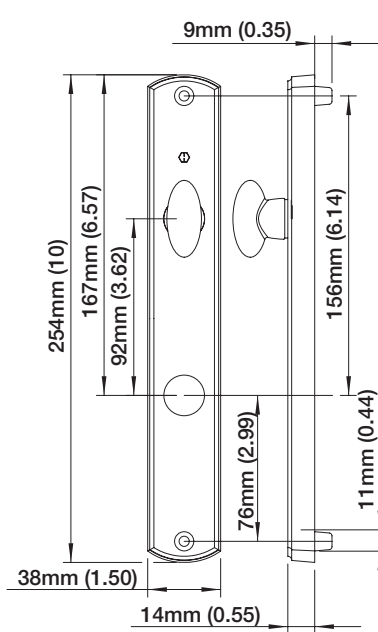

Interior Backplate

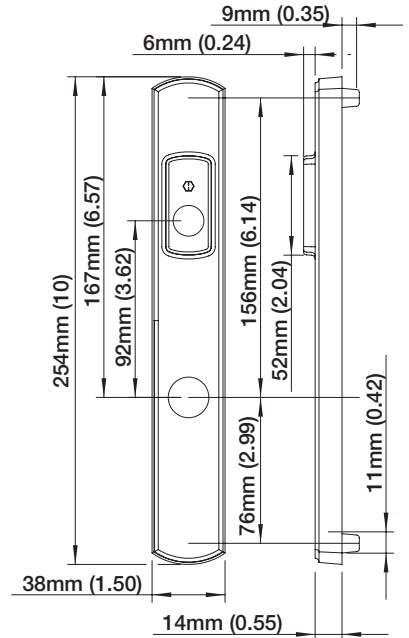

Exterior Backplate

	Satin
Model: M1610/2167N	Nickel
Material: Solid Brass	Resista® (F42-R)
Active Handle sets	2747061
Inactive Handle sets	2749787
Dummy Handle sets	

Active Door Sets have a cylinder on the outside backplate and a thumbturn on the interior backplate.
Inactive Door Sets have only the thumbturn on the interior plate.
Pair Fixed Dummy Sets do not operate.

Ródos Series

Ródos
Solid Brass
M1603/2167N

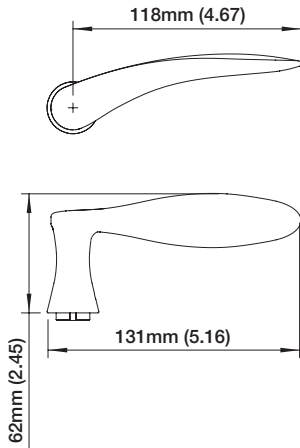
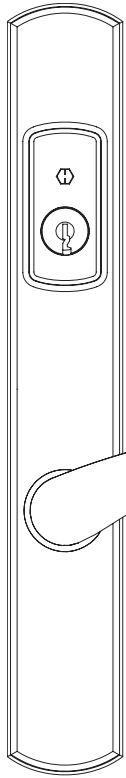

Right Hand Shown

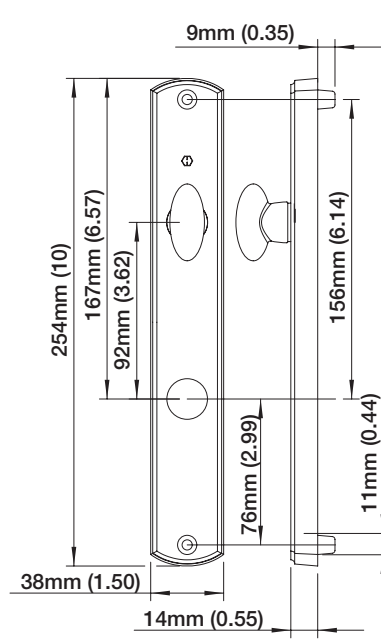

Interior Backplate

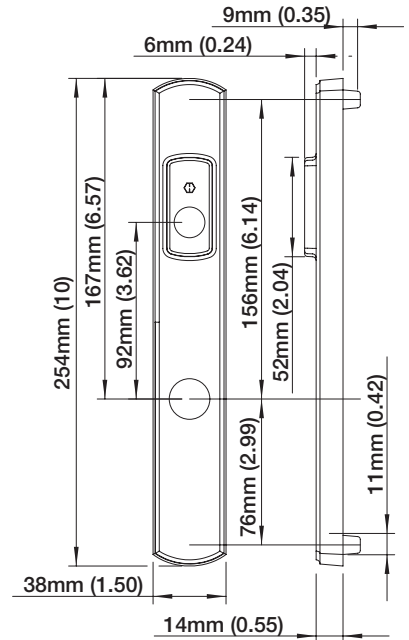

Exterior Backplate

Active Door Sets have a cylinder on the outside backplate and a thumbturn on the interior backplate.
Inactive Door Sets have only the thumbturn on the interior plate.
Pair Fixed Dummy Sets do not operate.

München
Solid Brass
M112P

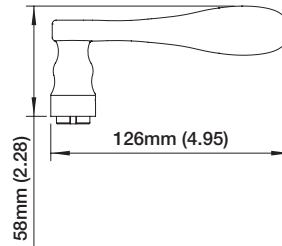
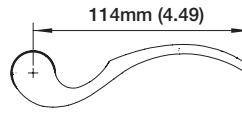
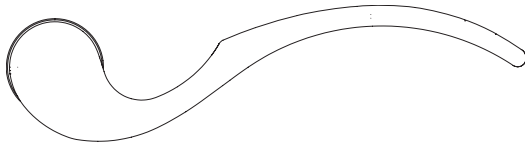

Right Hand Shown

Description	Resista Brass (F77-R)	Brushed Chrome (F41-R)	Polished Chrome (F49-R)	Matte Black (F9714)	Satin Nickel (F42-R)	Rustic Umber (F8709)
RH Handle	2789527	2789471	2789501	2789551		2790843
LH Handle	2789439	2789383	2789412	2789463	2789391	2790835

All handles include HOPPE's Quick-Fit Connection™* and Handle Release Tool.

Verona
Solid Brass
M151

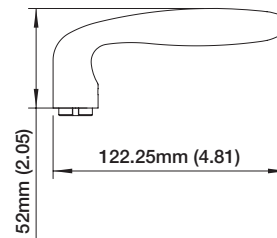
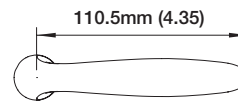
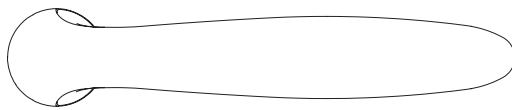

Non-Handed

Description	Brushed Chrome (F41-R)	Polished Chrome (F49-R)	Matte Black (F9714)	Satin Nickel (F42-R)	Rustic Umber (F8709)
Non-Handed	2789922	2789957	2790018	2789931	2789990

All handles include HOPPE's Quick-Fit Connection™* and Handle Release Tool.

Handle Components

Toronto
Solid Brass
M1020

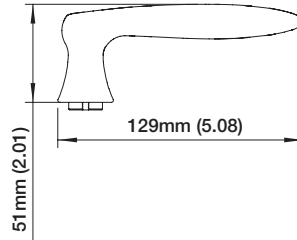
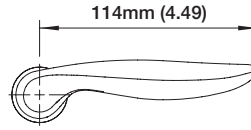
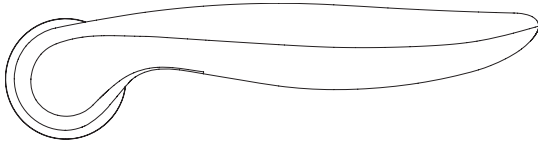

Description	Rustic Umber (F8709)
RH Handle	
LH Handle	2789797

All handles include HOPPE's Quick-Fit Connection™ and Handle Release Tool.

Ródos
Solid Brass
M1603

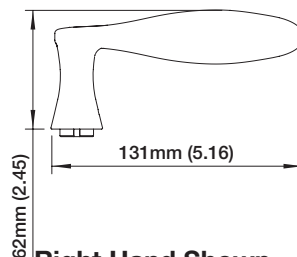
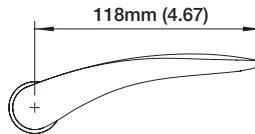
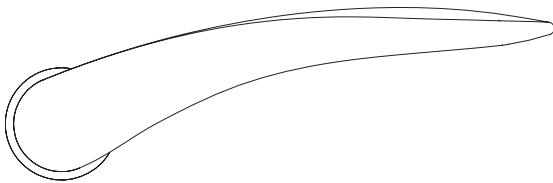

Right Hand Shown

Description	Brushed Chrome (F41-R)	Matte Black (F9714)	Satin Nickel (F42-R)	Rustic Umber (F8709)
RH Handle	2789640	2789711	2789658	2789703
LH Handle	2789560	2789631	2789578	2789623

All handles include HOPPE's Quick-Fit Connection™ and Handle Release Tool.

Backplate
Solid Brass
M2167N

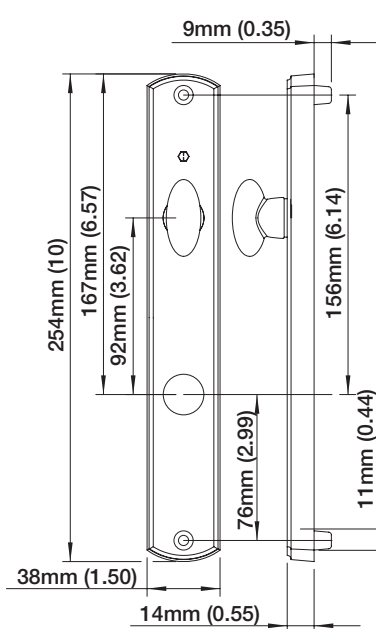
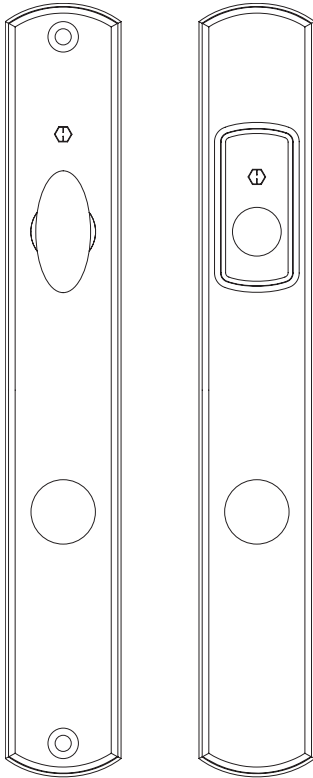

Interior Backplate

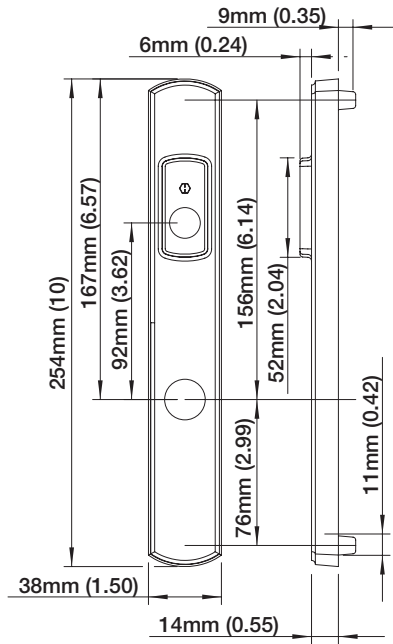

Exterior Backplate

Description	Brushed Chrome (F41-R)	Pure White (F9010)	Satin Nickel (F42-R)
Active or Inactive Interior - with thumbturn	2743625	2744290	2744142
Active Exterior - with thumbturn		2791731	2791758
Inactive Exterior - no thumbturn	2792291		

All interior backplates include gasket, bushing, mounting screws and thumbturn for 45mm (1.75) door thickness.
All exterior backplates include gasket and bushing.

Backplate Components

Backplate
Solid Brass
M2172N

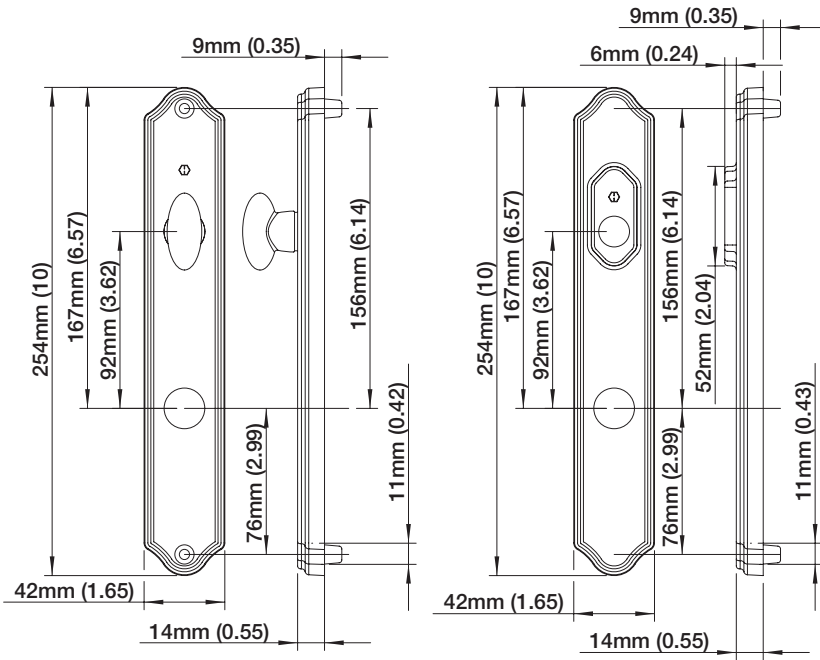
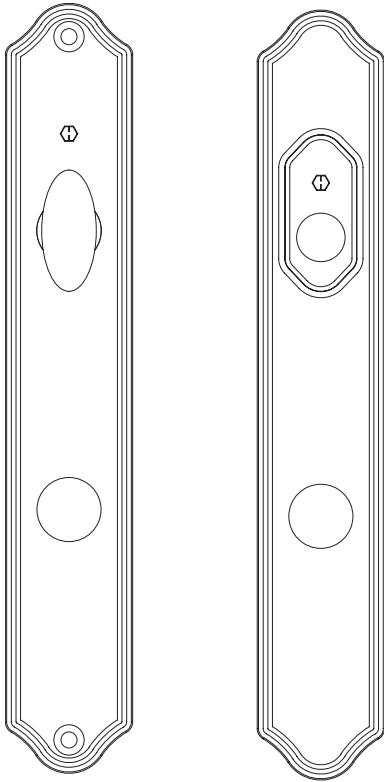

Interior Backplate

Exterior Backplate

Description	Brushed Chrome (F41-R)	Polished Chrome (F49-R)	Oil-Rubbed Brass (F79)	Satin Nickel (F42-R)
Active or Inactive Interior - with thumbturn	2744311	2744345	2744370	2744329

All interior backplates include gasket, bushing, mounting screws and thumbturn for 45mm (1.75) door thickness.
 All exterior backplates include gasket and bushing.

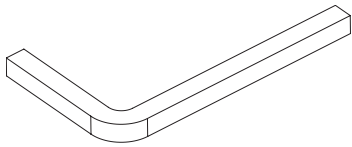

Construction Handle	Part Number
Steel C-Handle 8mm	2426890

Use during construction to operate latch.
May be used with construction backplate.
A construction handle is included in each new handle set.



Screws for Construction Plate

	Part Number
2 per plate	2591511

Sold separately from backplate

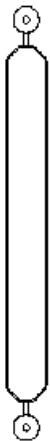

Construction Backplate

Door Thickness	45mm	57mm
	(1.77)	(2.24)
Part Number	2760791	2774667

Exterior backplate to use during construction phase to cover door prep holes.
Prevents operation of the latch and locking mechanism from the outside.

Add Interior Backplate that was created for Kawneer
Also add ISO view of construction backplate.

Replacement Parts

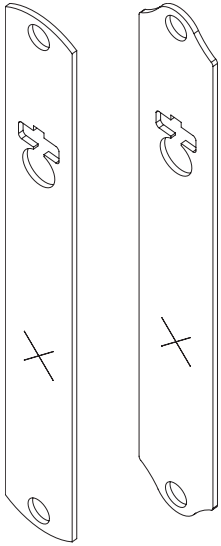

M2167N M2172N

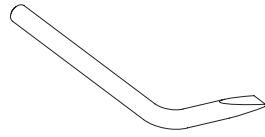

Quick-Fit Connection™ Handle Tool

Description	Part Number
For Removal of Handle	7192488

Backplate Gaskets

Description	Part Number
M2167N Backplate	2737559
M2172N Backplate	2737567

Parts Pack for Active Handle Set - 2 Each C-Washers, Spring Cartridges, Cylinder Screws & Handle Spindles
1 Each Handle Release Tool and Black Plastic Insert

	45mm (1.77)	57mm (2.24)	57mm Offset (2.24)
Part Number	2753954	2776136	3084211

Parts Pack for Inactive Handle Set - 2 Each C-Washers, Spring Cartridges & Handle Spindles
1 Each Handle Release Tool, Black Plastic Insert and 76mm Tailpiece to Insert in Plastic Insert

	45mm (1.77)	57mm (2.24)	57mm Offset (2.24)
Part Number	2753920	2753938	3084220

All items are included in handle sets.

HLS®7 Series Active Panel Trim Installation Instructions

A Phillips screwdriver is required.

A Quick-Fit Connection release tool (for removing handles if necessary), and a construction handle are provided in the hardware package.

Use only water and a soft cloth to clean trim. Do not use brass cleaner or solvent-based cleaning agent, as it will remove the protective coating.

Note: Handles and backplates vary by style but the application is the same.

1. Remove any construction trim that was previously installed.
2. Make sure locking system is fully unlocked before proceeding with trim installation. To be certain, insert construction handle into the interior handle hub and push handle down until latch retracts. Next, allow latch to return, and remove construction handle. All locking mechanisms will now be in unlocked position and trim may be installed.
3. Insert black tail piece adaptor into base of thumbturn.
4. Secure cylinder to exterior backplate with (2) 14mm (9/16") screws provided. It is important to be sure cylinder is evenly positioned, and screws are not overtightened.
5. Press nylon handle bushings (2 provided) into backplates.
6. **IMPORTANT:** Handle portion of shaft is identified with a chamfered end and a notch in each side edge. Slide C-washer into groove in shaft, and pass handle portion of shaft through underside of backplate. Be certain that C-washer properly seats into backplate as shown below.
7. While holding C-washer in place, push handle onto shaft until handle stops at backplate. Properly orient direction of handle for right hand or left hand, and slide spring cartridge onto shaft until cartridge rests into backplate. For left hand handles, spring cartridge should be positioned with springs below shaft. For right hand handles, spring cartridge should be positioned with springs above shaft. Turn backplate over, and place end of shaft against a solid surface. Push handle firmly onto shaft to completely secure handle to backplate.
8. Apply gasket to underside of each backplate.
9. Apply exterior trim to door stile while aligning shaft and cylinder tail piece into gear. Cylinder tail piece slot in gear should be in the vertical position – if not, repeat step 2 before installing trim.
10. While holding exterior trim in place, apply interior trim in the same manner, and joining cylinder tail piece to appropriate slot of black adaptor in thumbturn. Both tail piece and thumbturn should be in the vertical position as shown below.
11. Fasten backplates with 2 screws provided. Tighten screws with Phillips screwdriver. **DO NOT OVERTIGHTEN.**

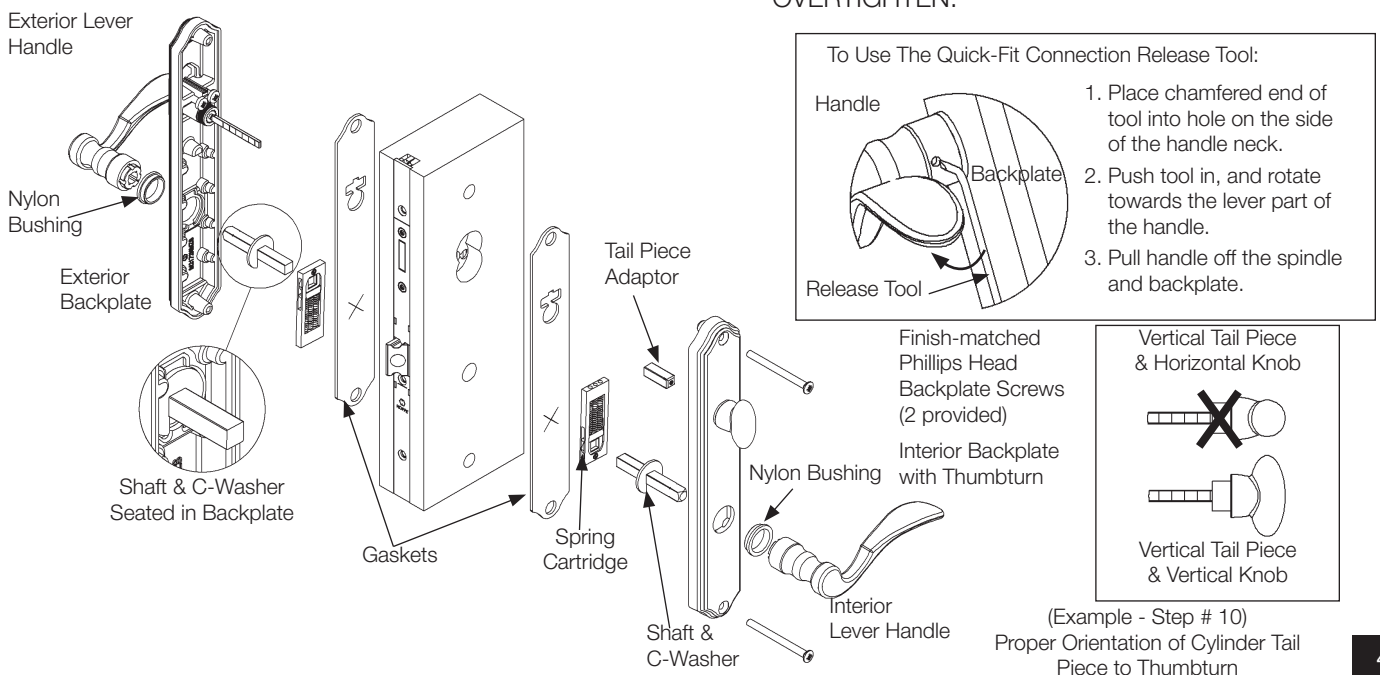

(Example - Step # 10)
Proper Orientation of Cylinder Tail Piece to Thumbturn

HLS®7 Series Active Panel Operation Instructions

Active Gear Operating Sequence

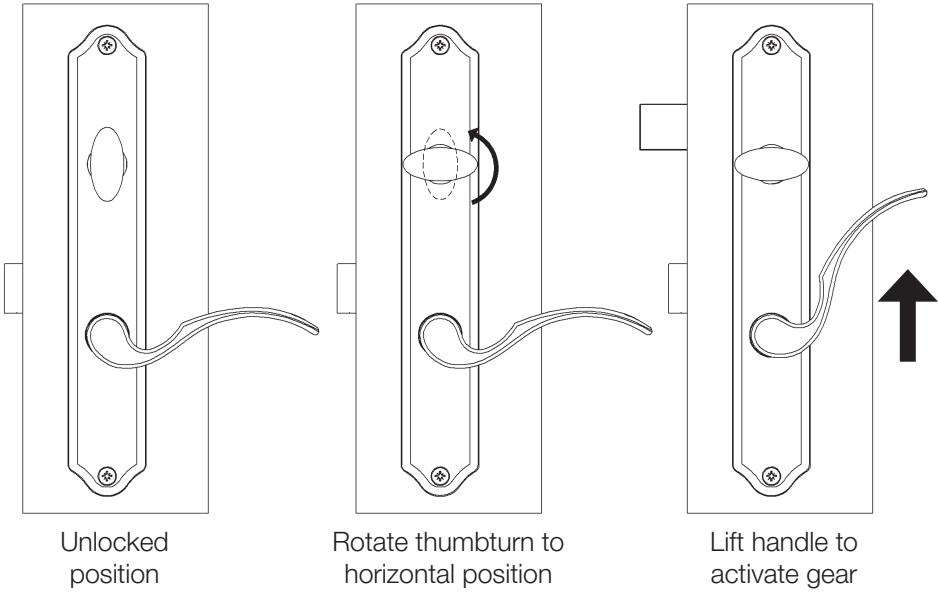

Simultaneous Retraction

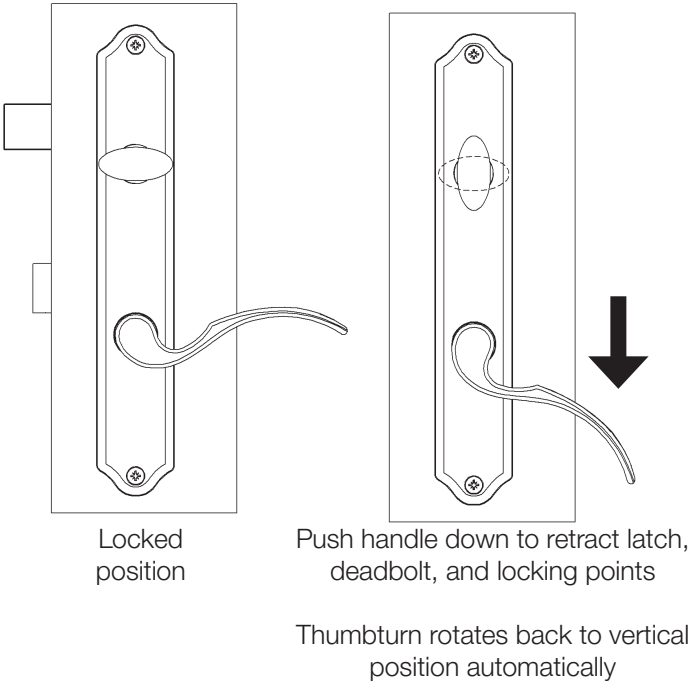

HLS®7 Series Inactive Panel Handle Set Installation Instructions

A Phillips screwdriver is required.

A Quick-Fit Connection release tool (for removing handles if necessary), and a construction handle are provided in the hardware package.

Use only water and a soft cloth to clean trim. Do not use brass cleaner or solvent-based cleaning agent, as it will remove the protective coating.

Note: Handles and backplates vary by style but the application is the same.

1. Remove any construction trim that was previously installed.
2. Insert tail piece with adaptor into base of thumbturn.
Be sure tail piece matches the same horizontal/vertical direction of the thumbturn when inserted.
See illustration below.
3. Press nylon handle bushings (2 provided) into backplates.
4. IMPORTANT: Handle portion of shaft is identified with a chamfered end and a notch in each side edge. Slide C-washer into groove in shaft, and pass handle portion of shaft through underside of backplate. Be certain that C-washer properly seats into backplate as shown below.
5. While holding C-washing in place, push handle onto shaft until handle stops at backplate. Properly orient direction of handle for right hand or left hand, and slide spring cartridge onto shaft until cartridge rests into backplate. For left hand handles, spring cartridge should be positioned with springs below shaft. For right hand handles, spring cartridge should be positioned with springs above shaft. Turn backplate over, and place end of shaft against a solid surface. Push handle firmly onto shaft to completely secure handle to backplate.
6. Apply gasket to underside of each backplate.
7. Apply exterior trim to door stile while aligning shaft into gear.
8. While holding exterior trim in place, apply interior trim in the same manner, also inserting tail piece through slot in gear.
9. Fasten backplates with 2 screws provided. Tighten screws with Phillips screwdriver. **DO NOT OVERTIGHTEN.**

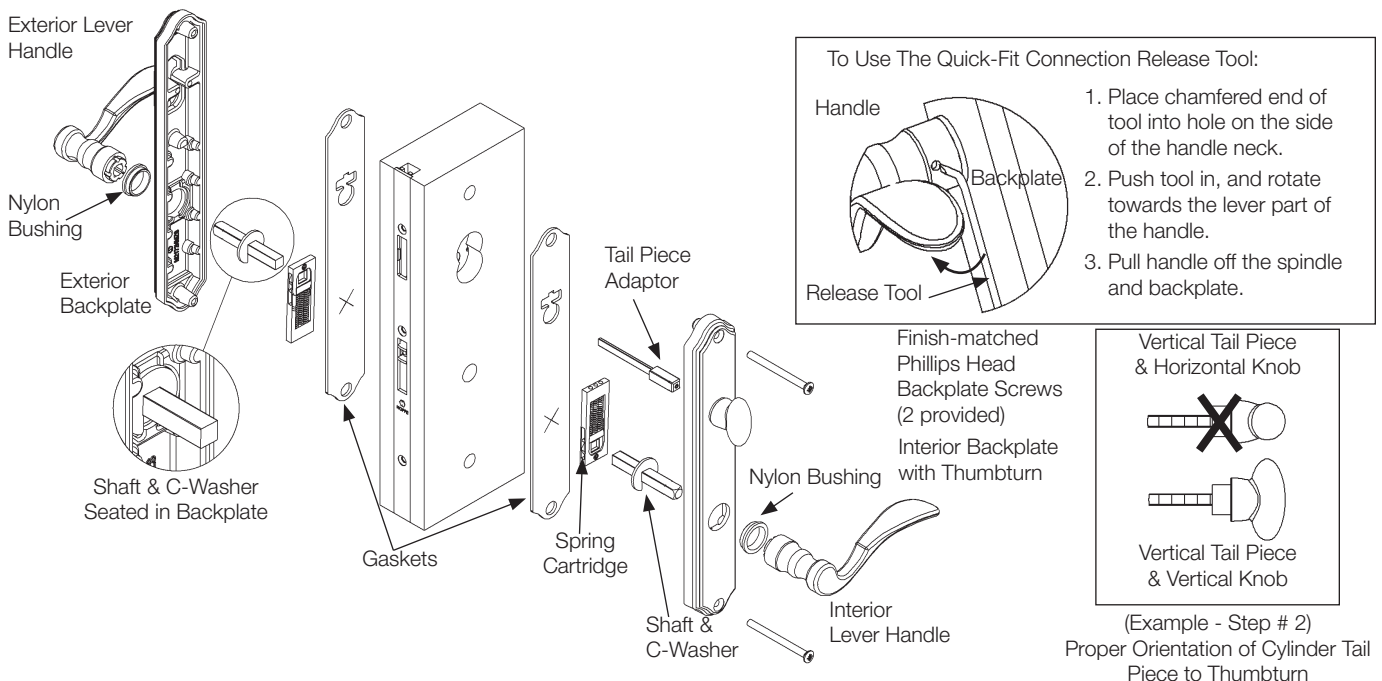

HLS®7 Series Inactive Panel Operation Instructions

Inactive Gear Operating Sequence

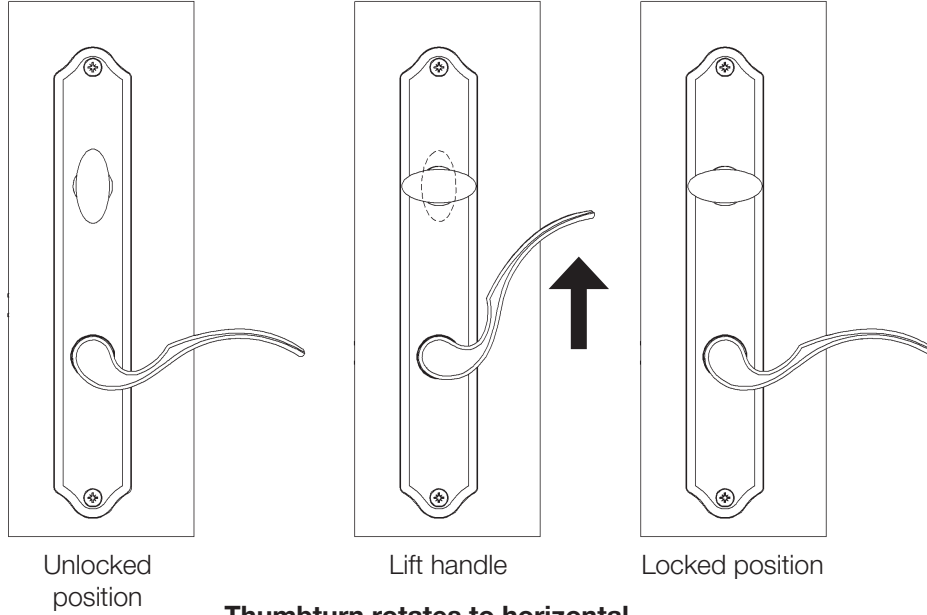

Thumbturn rotates to horizontal position automatically

Retraction of Inactive Gear

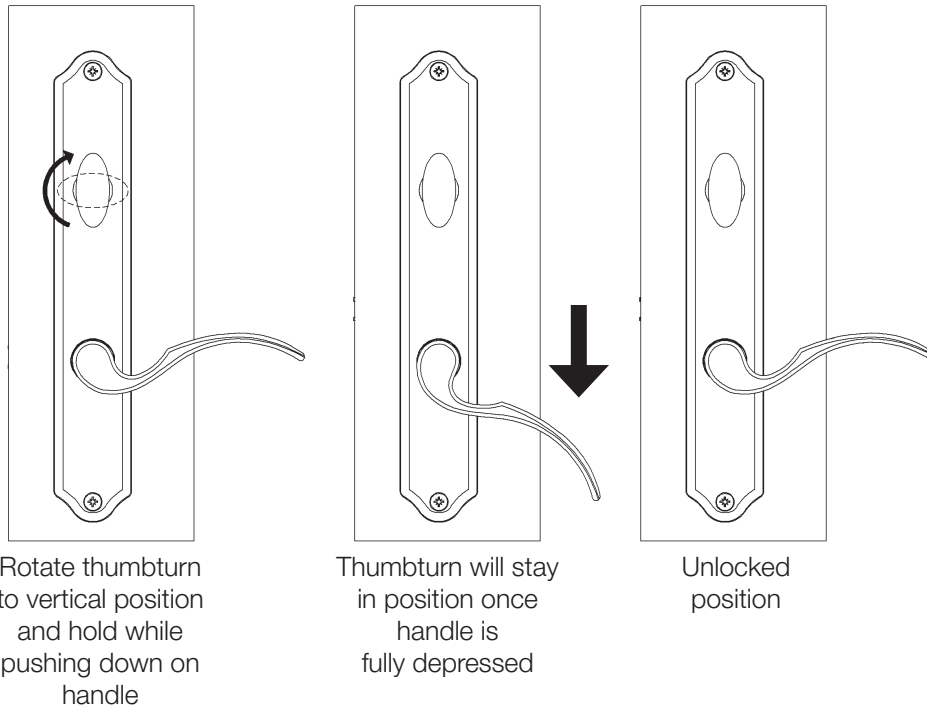



Handle Display Board
Description
Display boards are available in any handle series



Description	Part Number
10 Finishes F77-R, F73, F41-R, F49-R, F42-R, F44-R, F9010, F9714, F79, F8709	2216729

For more details on obtaining sales tools above, contact your local representative.

Active Door Set

Handle set used on the active panel. This set will always include a cylinder.

Active Panel

When a door is referred to as “active” it means it is the primary functioning door usually in a pair of French doors. This will be the door that opens first.

Astragal

Decorative center section of wood or other material that is attached to the inactive panel and serves as a jamb.

Backplate

Decorative plate which mounts to the face of the door with holes to accept the handle and cylinder, or thumb turn.

Backplate Screw

Screws that attach one backplate to the other. The screws enter through screw holes on the interior plate, travel through the door and attach directly to the exterior plate. Available in a variety of lengths to accommodate different door thicknesses.

Backset

Distance from the surface of the lock faceplate to the center of the handle hole. This distance establishes where the handle will be mounted to the face of the door.

Cylinder

The device used to lock a multipoint system and is activated with a key or thumbturn.

Cylinder Screws

Screws used to hold the cylinder in place after it is mounted into the exterior backplate.

Deadbolt

The center locking point on the door which is engaged with the other locking points when the handle is lifted.

Driverail

The vertical moving mechanism of multipoint hardware behind the faceplate. The driverail carries the motion from the gear to the multipoints to activate them. This can be achieved through a single part or through multiple parts hooked together such as extensions and corner drives. The driverail is hidden by the faceplate.

Engage

A term used to describe the activating of the multipoint hardware. When the multipoints have been activated into position, the system is said to be engaged.

Eurogroove

Routed groove in the edge of the door, usually centered, but may be offset to one side in which the drive rail and faceplate of the multipoint hardware are mounted.

Extension

Sections of operating drive rail that can be attached to the gear to reach the needed height of a door.

Faceplate

Flat piece of metal that covers the drive rail and multipoints along the entire length of the door sitting flush with the edge.

Fixed Dummy

Handle set is usually “fixed” in place. Handles serve only as pull handles and do not operate. Usually used on inactive panels where a mortise flush bolt has been used. These sets have no cylinder holes in either backplate.

Frame

The outer casing of a door which mounts directly into the rough opening of a wall.

Gear

Main functioning body of multipoint hardware containing hub for handle operation and deadbolt (on active gear).

Handle Height

The distance from the bottom of the door panel to the center of the handle hole.

Handle Set

Kit which includes handles, backplates and screws and may also include a cylinder.

Inactive Door Set

Handle set used on the inactive panel. This set will have a thumbturn on the inside and will not have a cylinder or cylinder hole on the outside.

Inactive Hardware

Hardware used on the inactive panel, no latch or deadbolt.

Inactive Panel

When a door is referred to as “inactive” it means it is the secondary functioning door in a pair of French doors. This door can only be opened after the “active” panel has been opened.

Jamb

See frame.

Latch

The catch for the door.

Lockcase

The main body of the multipoint gear.

Machine Screw

Screw that is used with a tapped hole.

Mortise

Edge pocket for lockcase or additional locking points.

Mortise Lock

Any hardware containing a gearbox that requires pocket routing in the edge of a door in order to be mounted or installed.

Hardware

Any hardware that has multiple locking points which simultaneously lock into place through the action of a continuous travel drive rail activated by a handle.

Profile

A UPVC or aluminum extrusion used in door manufacturing. The shape/style of each extrusion differs between each extruder and therefore requires different hardware—particularly hinges and strike plates.

Rod Lock

A gearbox that uses a solid metal rod to secure a door when there is not an astragal between the door panels. The rods extend until engaged into the head and sill of the frame.

Roller

Small cylindrical cam locking point that is connected to the drive rail and secures inside a strike plate by an upward and downward movement along the surface of the faceplate.

Screw Support

A support on the backside of the gear for the screws which helps prevent flexing or bending of the gear once installed in the edge of the door.

Shootbolt

Arrow shaped locking point that retracts into the eurogroove until engaged, at which point it extends out and locks into strike plates in the head and sill of the frame.

Sill

Bottom portion of an opening that rests on the foundation and supports the frame structure.

Spindle

Metal shafts used to mount the handles to the door. Available in different lengths to accommodate a variety of door thicknesses.

Stile

Upright or vertical piece of the framework of a wood flush door.

Strike Plates

Plates that the locking points (roller, tongue, swinghook, deadbolt or latch) lock into. Different strike plates are required for different versions of locking points and profile designs.

Swinghook

Hook shaped locking point that retracts into the faceplate until engaged when it extends the reach into the jamb.

Threshold

The horizontal bottom portion of the door frame, also called the sill.

Throw

Distance a locking point travels from surface of faceplate to point of full extension.

Tongue

Triangular shaped locking point that retracts flush inside the faceplate until engaged, at which point it extends out to lock into a strike plate.

Wood Screw

Screw with a tapered shaft that drills its own hole into the wood.





Handle of excellence.

HOPPE North America, Inc.
205 E. Blackhawk Drive
Fort Atkinson, WI 53538-1268

 920-563-2626

 920-563-4408

 1-888-485-4885

 info.us@hoppe.com

 www.us.hoppe.com

