

NEUROSONIC®

Harmonia

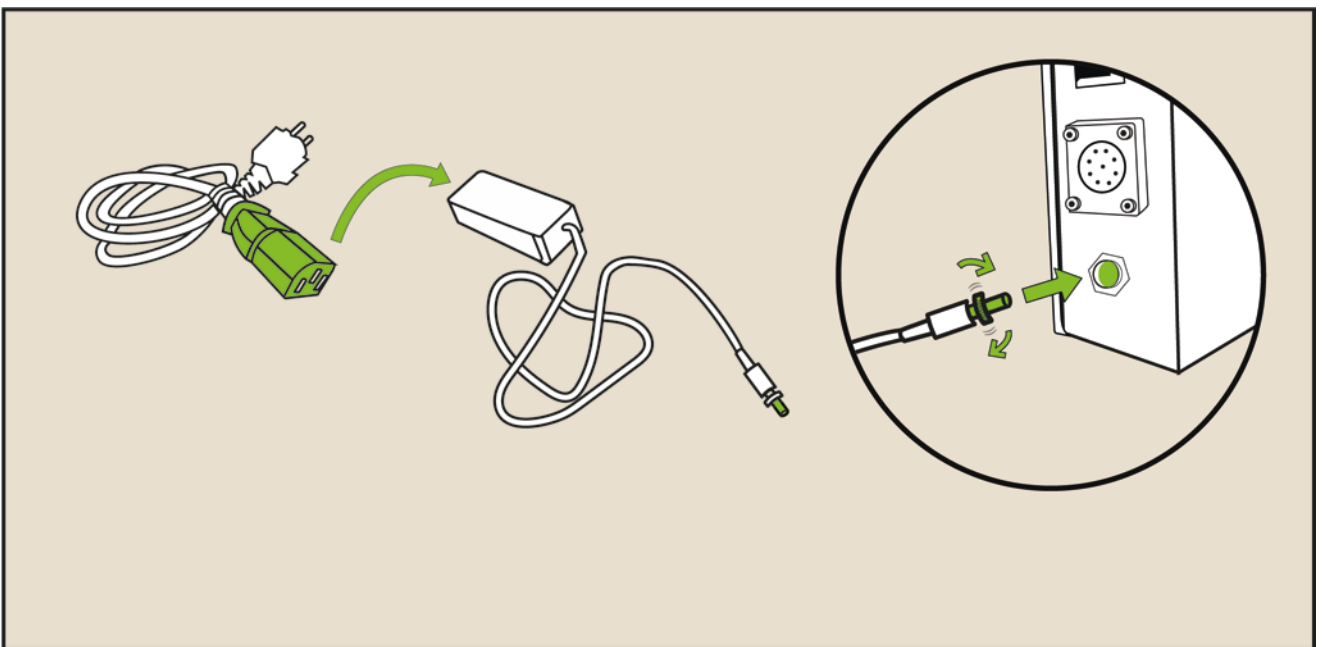

Quick guide

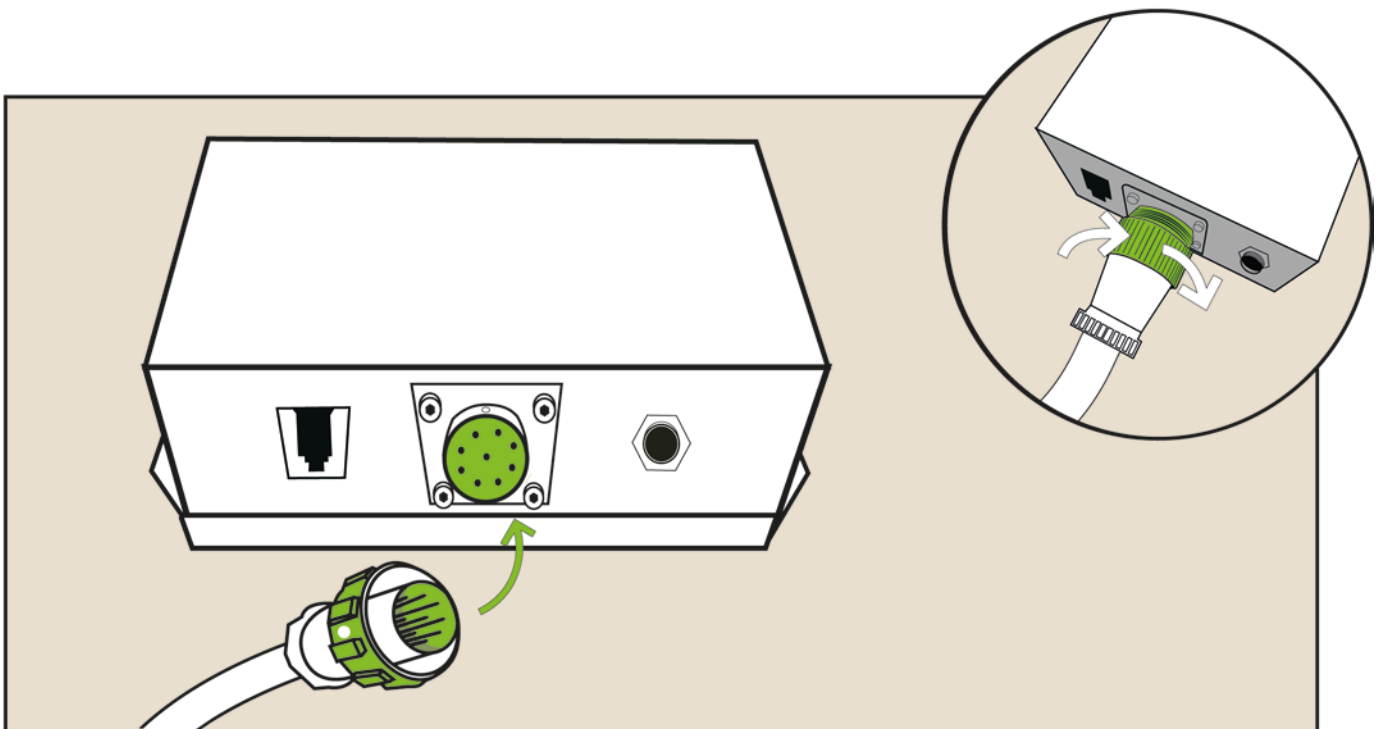
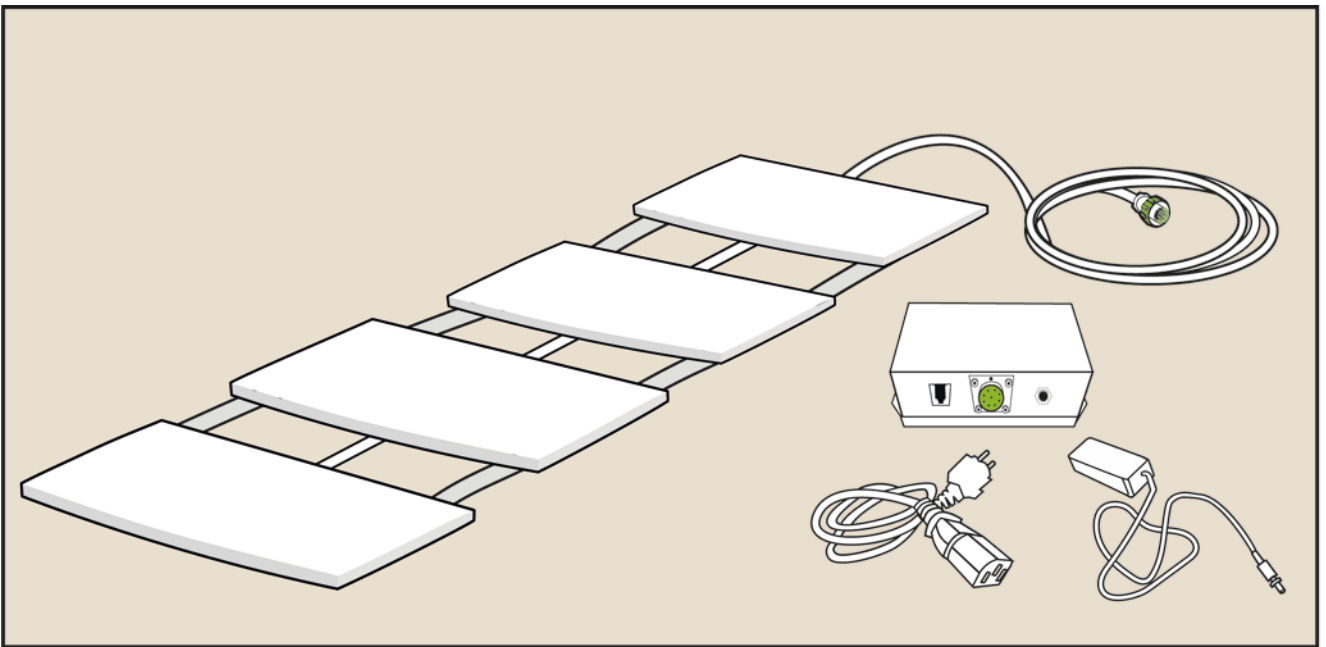

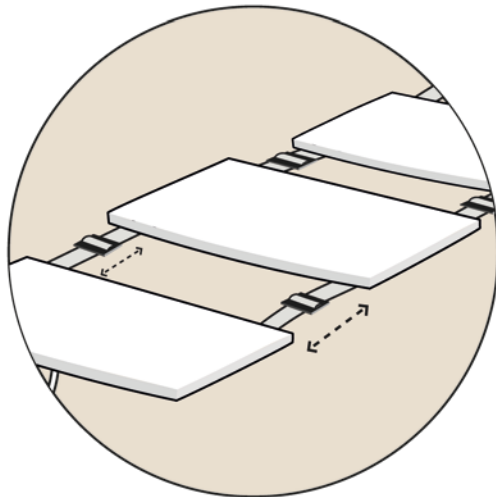
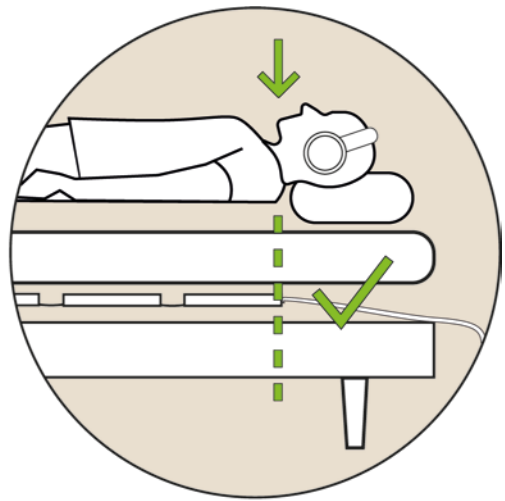
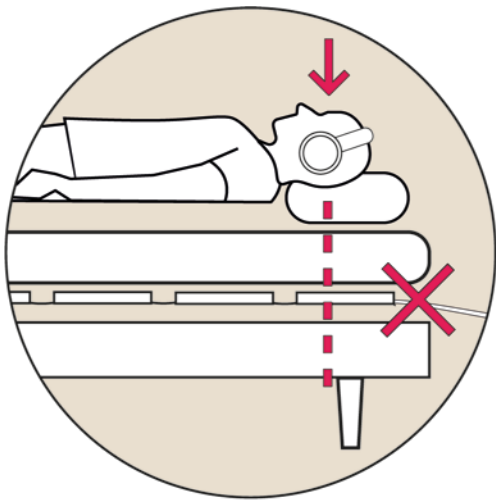
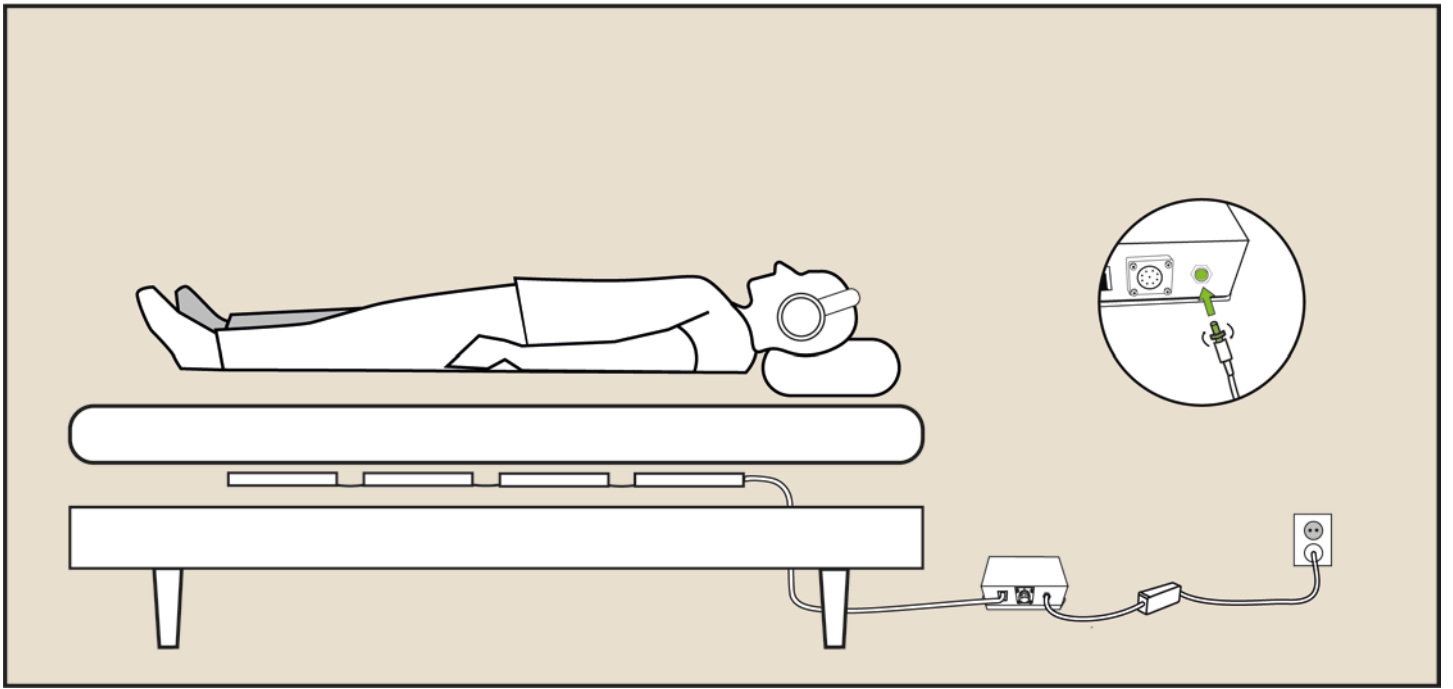

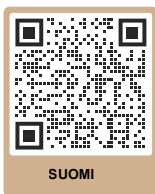
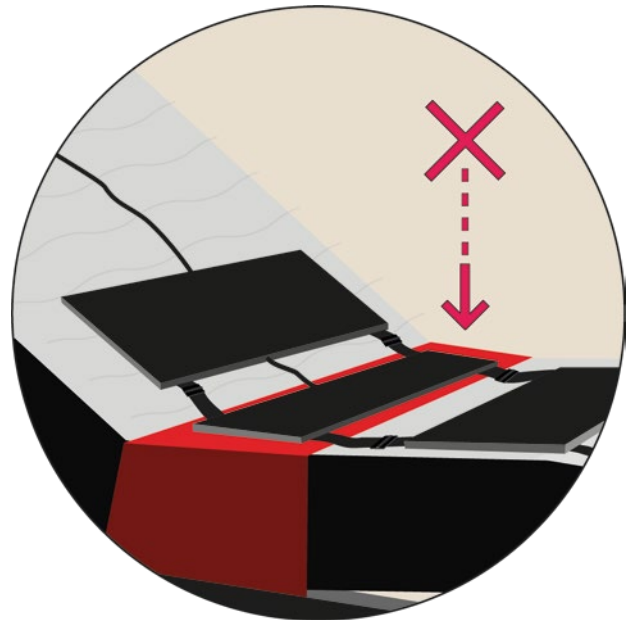
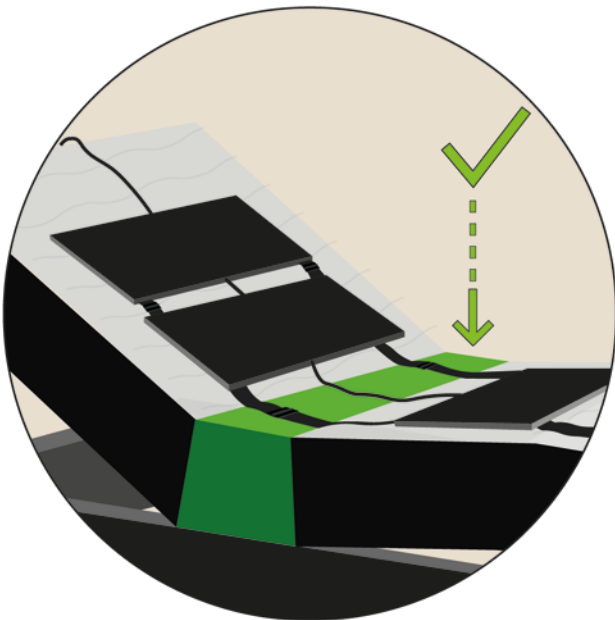
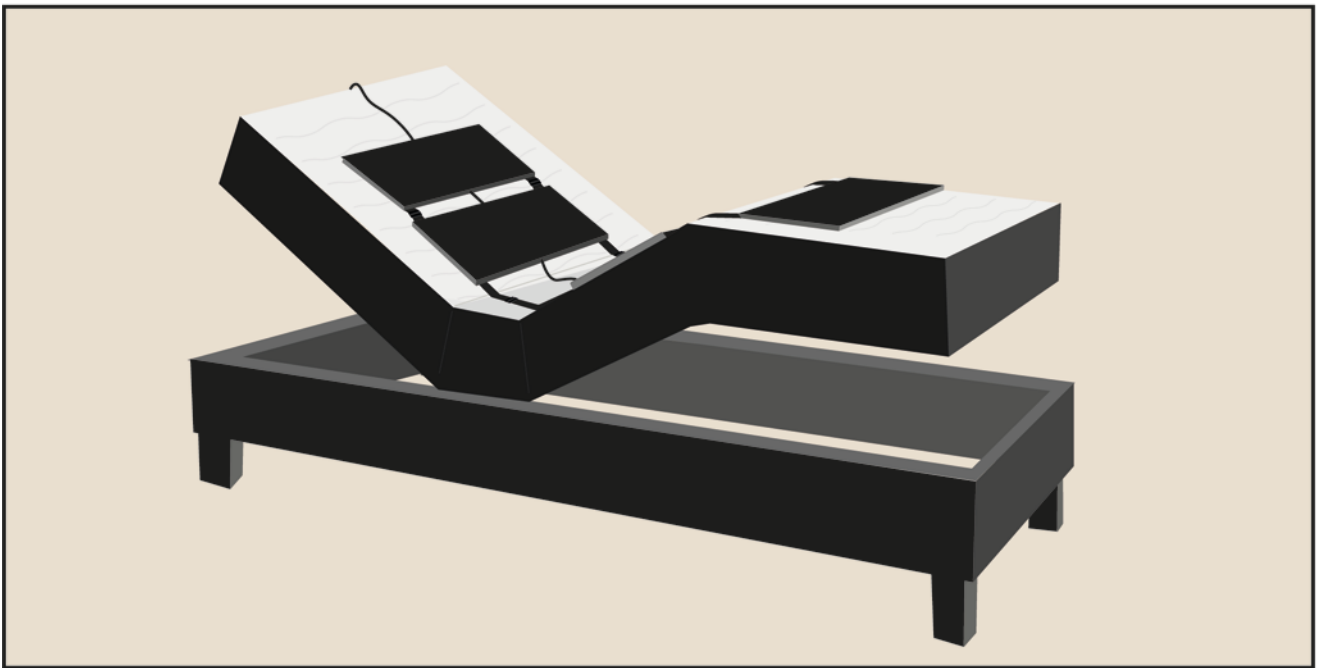

SUOMI

[Neurosonic.fi](https://neurosonic.fi)



SVENSKA

[Neurosonic.se](https://neurosonic.se)

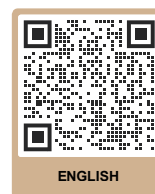

ENGLISH

[Neurosonictech.com](https://neurosonictech.com)



NEUROSONIC[®]

EU Declaration of Conformity

1. **Product model:** Neurosonic

2. **Name and address of the manufacturer or his authorised representative:**

Oy Neurosonic Finland Ltd
Saaristonkatu 1
90100 Oulu, Finland
+358 10 201 1610
info@neurosonic.fi

3. **This declaration of conformity is issued under the sole responsibility of the manufacturer.**

4. **Object of the declaration:**

Equipment: Neurosonic Controller
Brand name: Neurosonic
Model/type: WBV

5. **The object of the declaration described above is in conformity with the relevant Union harmonization legislation:**

Electromagnetic compatibility directive (EMC) 2014/30/EU
Radio Equipment Directive (RED) 2014/53/EU
LVD directive 2014/35/EU

6. **References to the relevant harmonised standards used or references to the other technical specifications in relation to which conformity is declared:**

RED: Article 3.2: Effective Use of the Radio Spectrum
ETSI EN 300 328 V2.2.2: 2019
Article 3.1 b): Electromagnetic Compatibility
ETSI EN 301 489-1 V2.2.3: 2019
ETSI EN 301 489-17 V3.2.4: 2020
EN 55032:2015+A11:2020
EN IEC 61000-3-2:2019
EN 61000-3-3:2013+A1:2019
EN 55035:2017+A11:2020
Article 3.1 a): Health and Safety
EN 62479:2010
EN 50663:2017
LVD: EN 62368-1:2014 + A11:2017

7. **Signed for and on behalf of:**

Helsinki, 2023-03-01

Manufacturer: Oy Neurosonic Finland Ltd

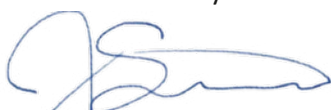

Juha Suoniemi, CEO