

Installation Drawing: I32

Version 1.0

Power cable connection



This installation drawing is an addition to the original operating instructions.
Read operating instructions before wiring.

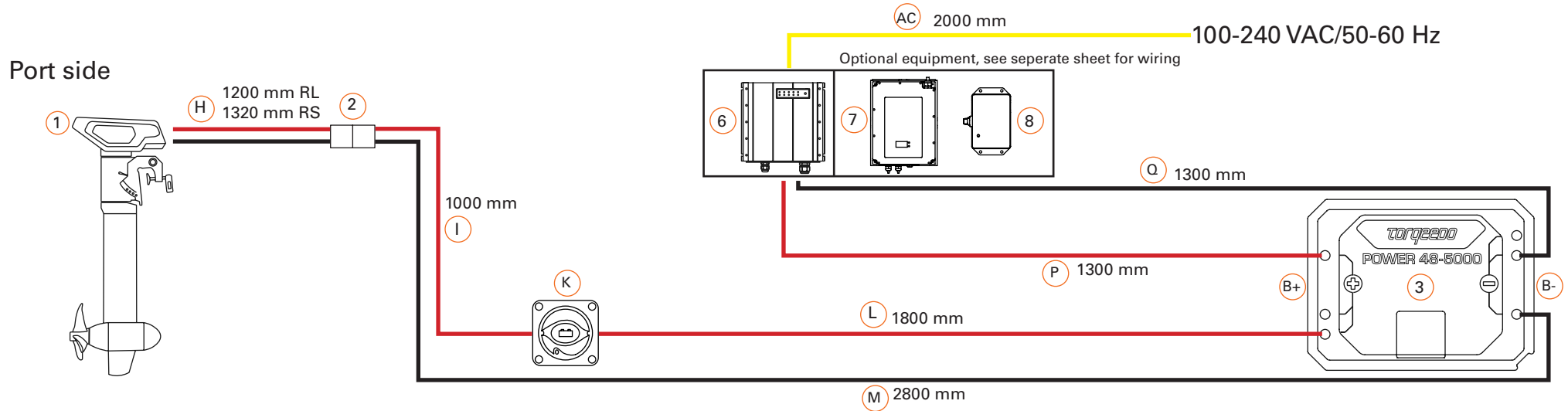

Starboard side

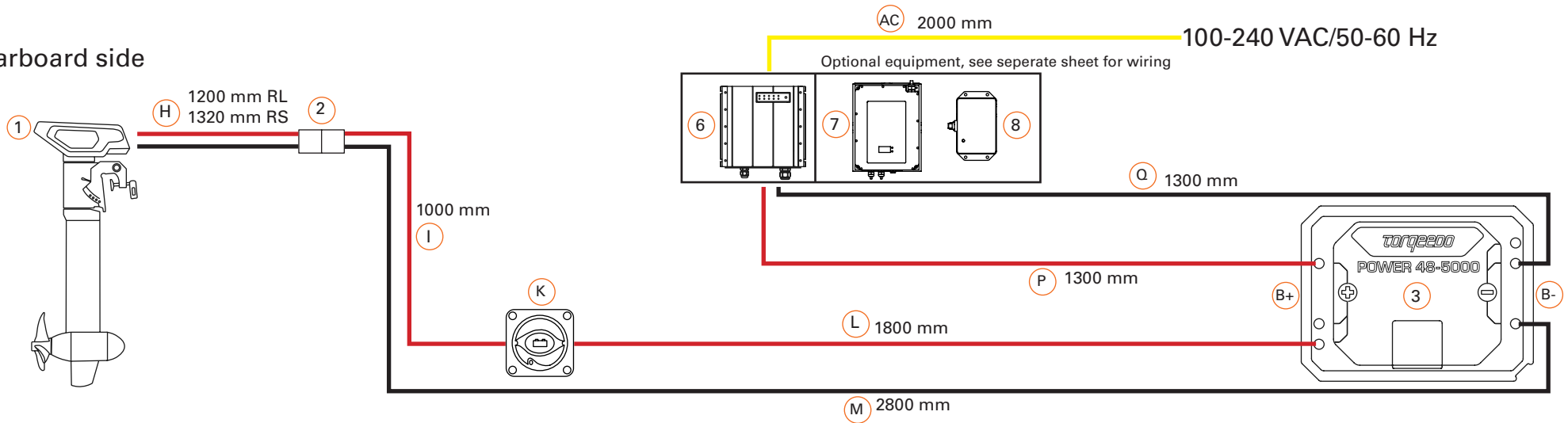

— Positive power cable
— Negative power cable

— Positive charging cable
— Negative charging cable

— AC power cable

Power cable connection

Installation Drawing: I32

Version 1.0

System ground connection



This installation drawing is an addition to the original operating instructions.
Read operating instructions before wiring.



Use for boats without common point for grounding

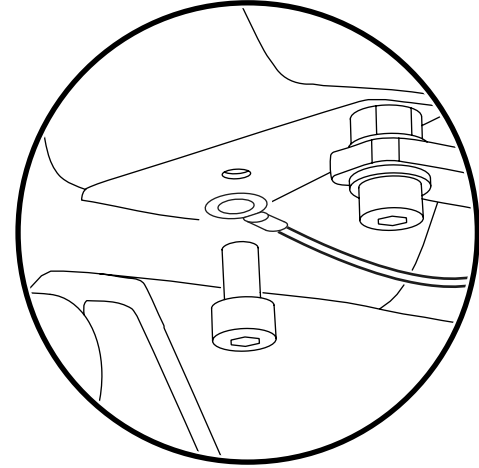
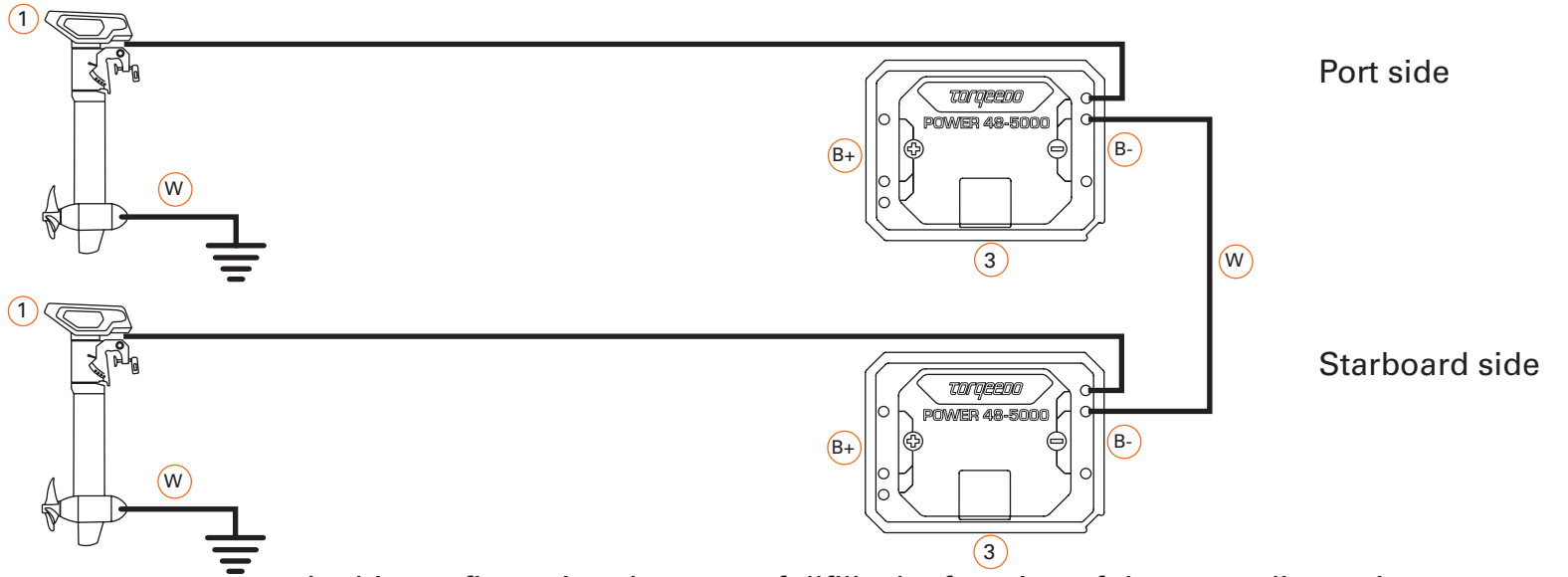

— 25 mm² grounding cable

In this configuration the motor fullfills the function of the grounding point

Use for boats with common point for grounding

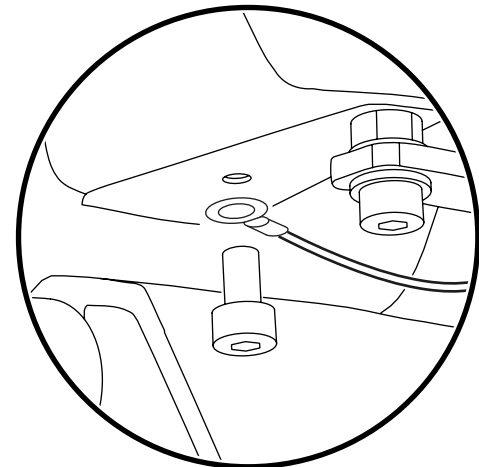
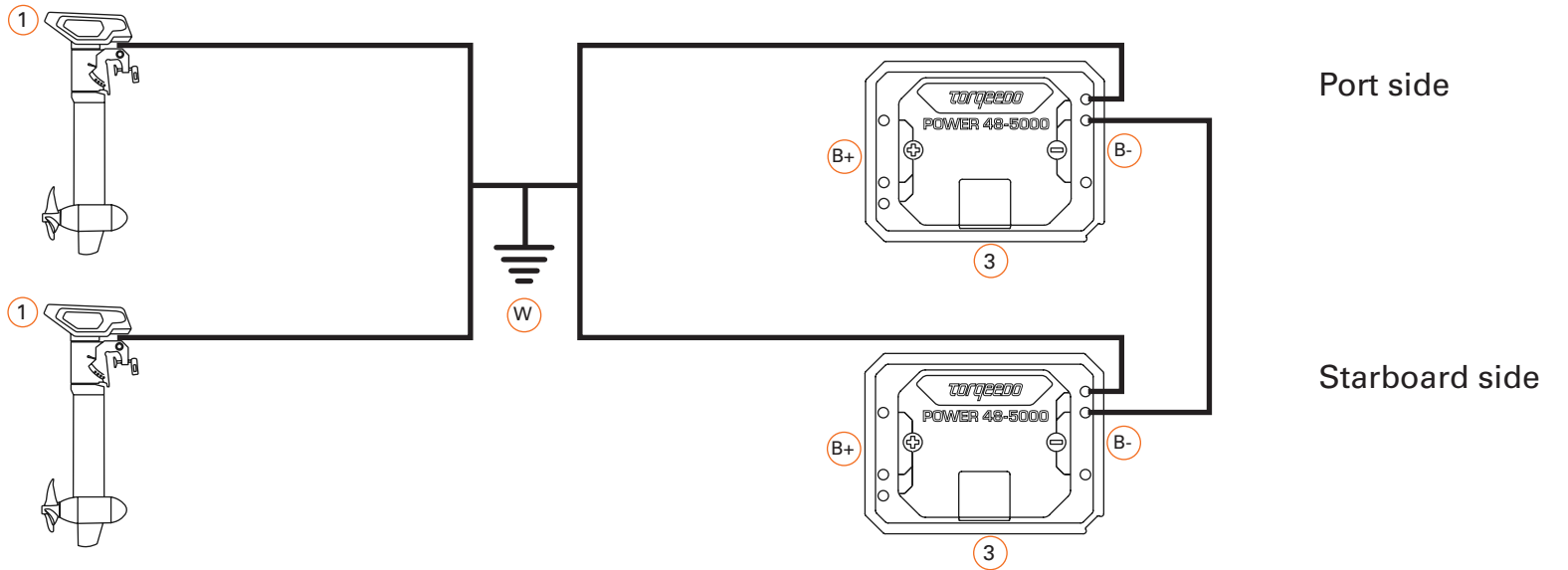

— 25 mm² grounding cable

System ground connection

Installation Drawing: I32

Version 1.0

System ground connection



This installation drawing is an addition to the original operating instructions.
Read operating instructions before wiring.



In case the charger is permanently installed in the boat, the charger housing or its AC PE and battery minus pole must be connected to the common grounding point. The AC connection requires specialist knowledge and may only be carried out by qualified personnel. If necessary, have the planning and installation carried out by a specialist.

NOTE! To charge the batteries in the boat, a land connection in the boat with galvanic isolator or isolation transformer is required according to applicable national requirements (e.g. DIN EN ISO 13297, ABYC E-11).

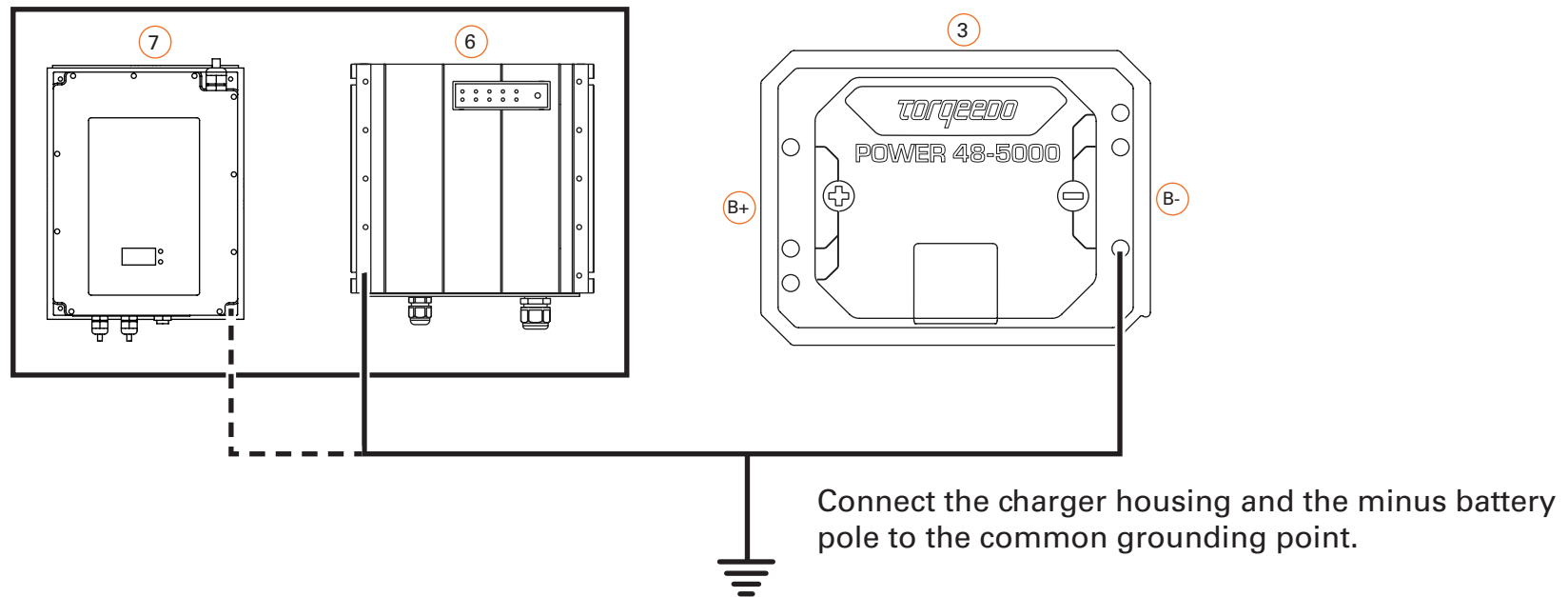

— 25 mm² grounding cable

System ground connection

Installation Drawing: I32

Version 1.0

Data cable connection



This installation drawing is an addition to the original operating instructions.
Read operating instructions before wiring.



Port side

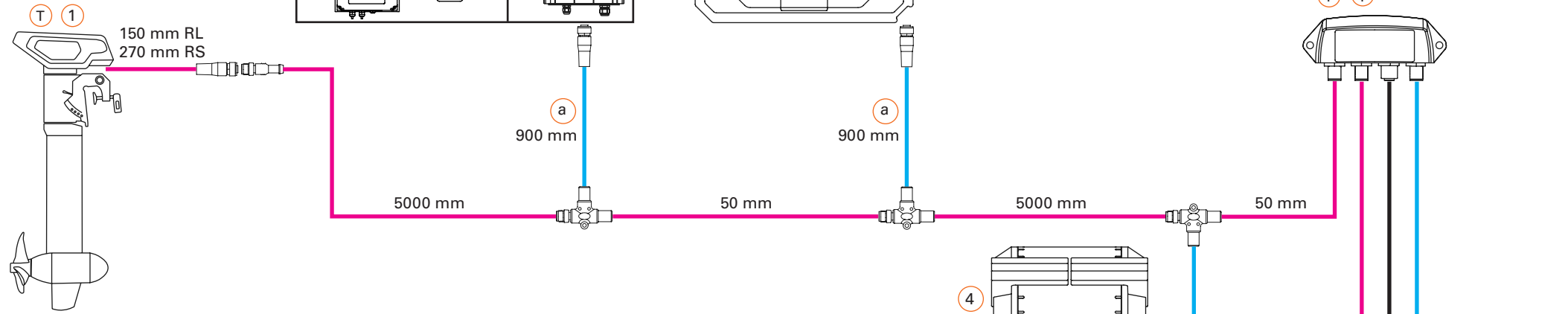

Starboard side

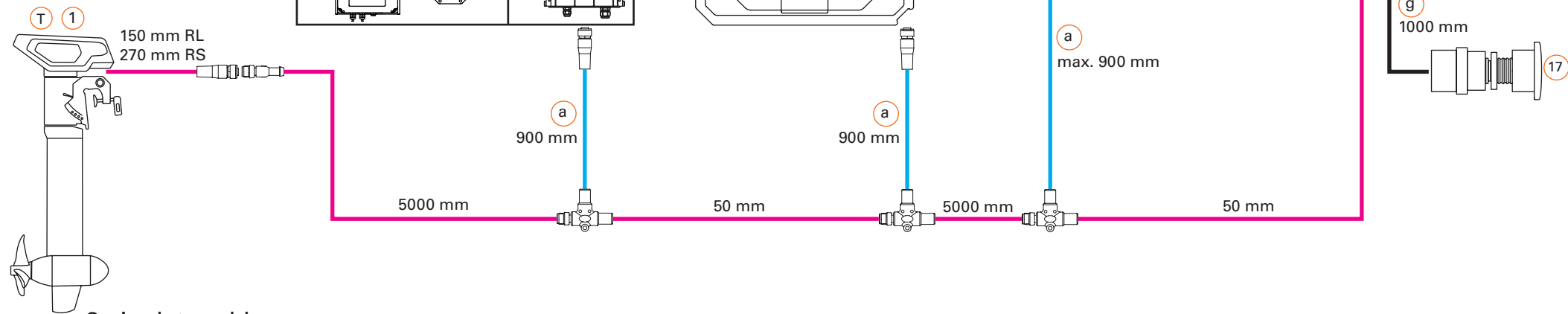

8 pin data cable

5 pin data cable

4 pin data cable

Backbone TorqLink, 8 pin data cable

Backbone 5 pin data cable

Ⓣ Bus system termination resistor

Data cable connection

Installation Drawing: I32

Version 1.0

Bill of material/Legend/Information



This installation drawing is an addition to the original operating instructions.
Read operating instructions before wiring.



Pos.	Item number	Name	Remarks
1	1262-00 1263-00	Cruise 6.0 R TorqLink	
H, I, K, L, M		Cable set with battery switch	See picture for cable length
2		Power connector	max. 175 A
b		Backbone TorqLink cable 8-pin	5000 mm
3	2104-00	Power 48-5000	Select TorqLink-Battery in throttle menu!
a		T-Cable 8-pin	900 mm/50 mm, Do not extend!
not illus- trated		+ Battery pole adapter - Battery pole adapter	Not needed for your configuration
W		System ground	min. 25 mm ² , not included
4	1952-00	Throttle Topmount Twin	
22	000-00858	Gateway	Do not use for your configuration!
U		Gateway Power cable 1700 mm cable	Do not use for your configuration!
b		Backbone TorqLink cable 8-pin	5000 mm
17		Emergency switch with cable	1000 mm
20		Key switch	
g		Cable for key switch 6-Pin to 8-pin	1000 mm
14	000-00877	TorqLink Terminator Twin	Bus termination resistor
a		T-Cable 8-pin	900 mm/50 mm, Do not extend!
6	2213-00	Charger Power 48	650 W, for AC charging while running use Fast charger Power 48 2212-00; Not compatible with solar charger 2218-00
P		+ DC charge cable	1300 mm; Do not extend!
Q		- DC charge cable	1300 mm; Do not extend!
B+		+ Battery pole	7,5 Nm
B-		- Battery pole	7,5 Nm
AC		AC power cable	2000 mm
a		T-Cable 8-pin	900 mm/50 mm, Do not extend!

Pos.	Item number	Name	Remarks
Optional equipment			
7	2212-00	Fast charger Power 48	2900 W
P		+ DC charge cable	2400 mm; Do not extend!
Q		- DC charge cable	2400 mm; Do not extend!
B+		+ Battery pole	7,5 Nm
B-		- Battery pole	7,5 Nm
AC		AC power cable	1000 mm
a		T-Cable 8-pin	900 mm/50 mm, Do not extend!
8	2218-00	Solar charge controller for Power 48-5000	For TorqLink system only! Only as stand alone charger or in combination with 2212-00 Fast charger Power 48!
P		+ Charge cable	1500 mm
Q		- Charge cable	1500 mm
R		+ Input solar cable	150 mm
S		- Input solar cable	150 mm
a		T-Cable 8-pin	900 mm/50 mm, Do not extend!

Installation Drawing: I32

Version 1.0

Bill of material/Legend/Information



This installation drawing is an addition to the original operating instructions.
Read operating instructions before wiring.

TORQUEEDO

Connect the cruise motor and terminator to each end of the backbone.
The TorqLink bus system requires a terminator (terminating resistor) at both ends of the backbone in order to function correctly.
One of the terminators is located in the „Terminator Single“, „Terminator Twin“, „Throttle 1918-00“, „Throttle 1976-00“, the other is built into the cruise motor. Therefore, when installing, make sure that the components „Terminator“ and „Cruise motor“ are each connected to one end of the backbone.
The connection position of the remaining components on the backbone can be freely selected.

Keep the following points in mind when planning:

- An earthing point is required for your Torqueedo system. Take into account the connection and the cables required for this in your planning. The required cable cross-sections can be found in the section Tools, equipment and material.
- First determine and plan the installation positions of all components.
- Measure the required length of the TorqLink backbone.
- Measure the lengths of all required stub lines (cable connection between component and TorqLink backbone).
- When planning, please note that TorqLink drop cables must not be extended. If necessary, plan the TorqLink backbone so that the components can be connected through the TorqLink drop cable without an extension. If necessary, extend the TorqLink backbone to connect a component that is far away; you can find corresponding extensions in our accessories catalogue.
- Cables must be fixed every 400 mm, plan attachment material. In places where fastening is not possible, a scuff guard must be fitted.
- Openly laid cables (e.g. inflatable boat) must be protected with chafing protection, plan sufficient material.
- When planning, please note not to bundle power cables with data or antenna cables (e.g. radios) for other loads.
- Observe the minimum bending radius of the cables when planning.
- If a second earthed onboard power system is available, ensure that both systems use a common earthing point.
- Live parts must be fitted or installed with protection against accidental contact; the necessary installation space must be taken into account during the planning stage.
- Always connect batteries as the last component to the system to avoid short circuits and voltage peaks.
- Do not extend drop cables, extend backbone if necessary.
- Protect plugs and contacts against contamination before installing them.
- Do not pull at the cables.
- Do not twist cables.
- Do not install cables in permanently wet areas such as bilges.
- Install cables free of chafing and not around sharp edges, if necessary, attach chafing protection.
- Maintain bending limits.
- Install plug connections free of tension and load.

Observe the minimum bending radius when laying all cables:

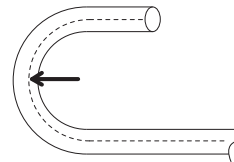

Torqueedo data cable	8 x diameter
Torqueedo power cable	8 x diameter
Earth cable	see cable manufacturer's specifications
Other power cables	see cable manufacturer's specifications

Installation Drawing: I32

Version 1.0

Power cable connection



This installation drawing is an addition to the original operating instructions.
Read operating instructions before wiring.



Port side

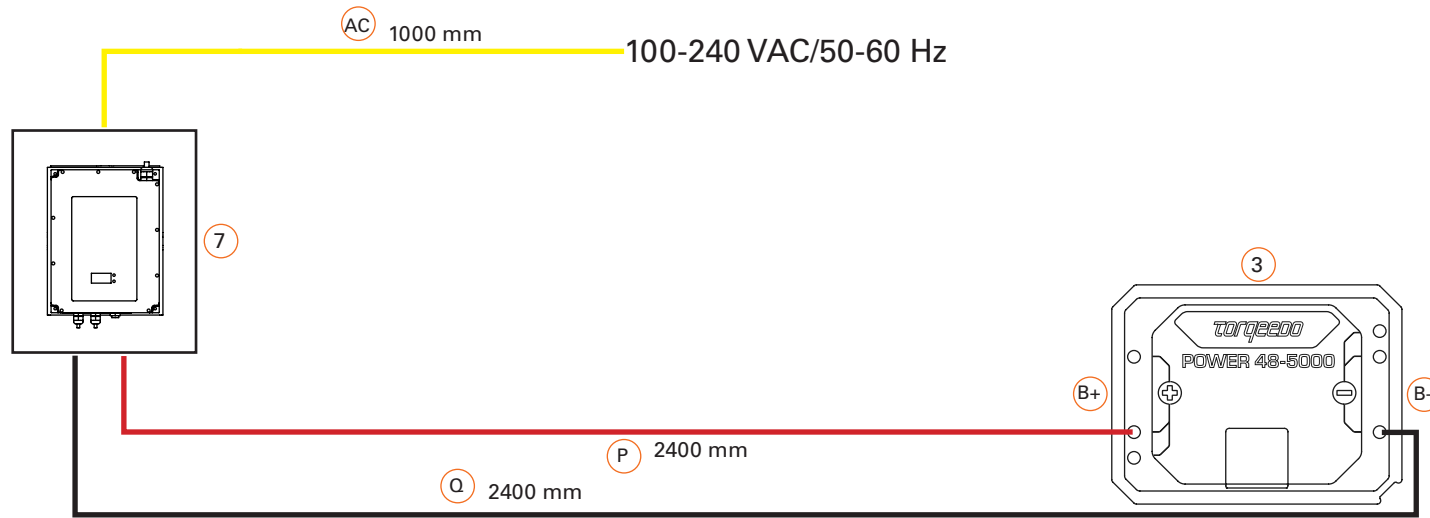

Starboard side

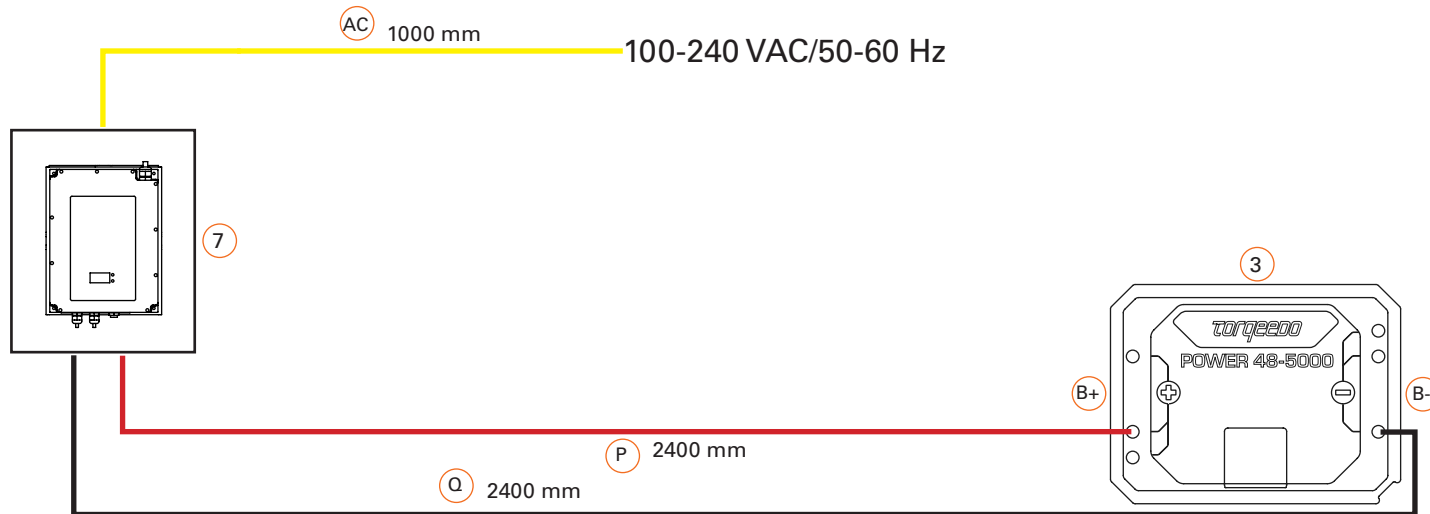

— Positive power cable
— Negative power cable

— Positive charging cable
— Negative charging cable

— AC power cable

Power cable connection

Installation Drawing: I32

Version 1.0

Power cable connection



This installation drawing is an addition to the original operating instructions.
Read operating instructions before wiring.



Port side

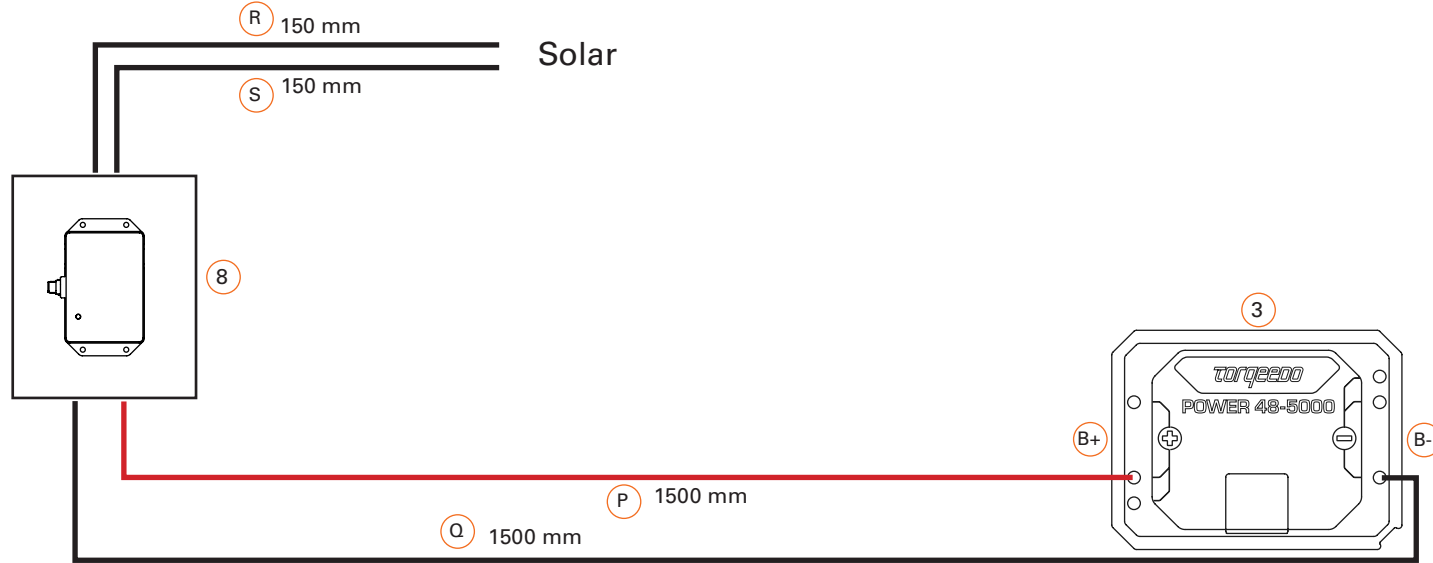

Starboard side

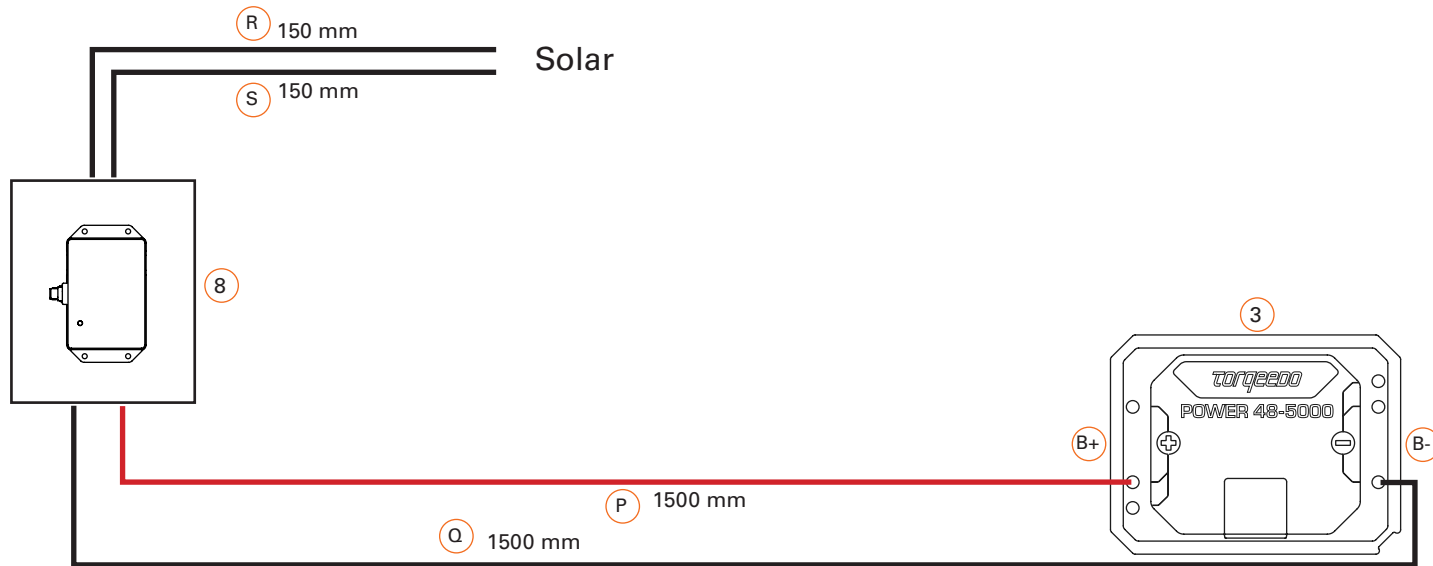

— Positive power cable
— Negative power cable

— Positive charging cable
— Negative charging cable

— AC power cable

Power cable connection