

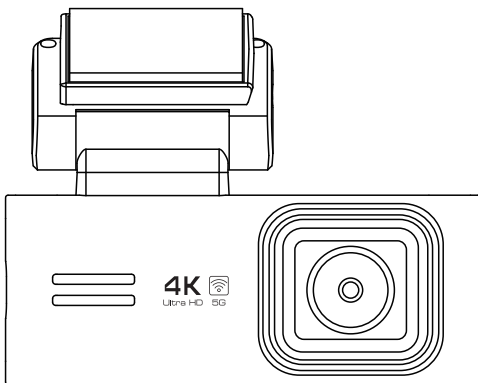

# User Manual

M572



# CONTENTS

CUSTOMER SERVICE .....	01
INTRODUCTION .....	02
IN THE BOX .....	03
SPECIFICATION .....	04-05
PRODUCT DIAGRAM .....	06
BUTTONS AND FUNCTIONS .....	07
INSTALLATION .....	08-09
USING OMBAR DASH CAM .....	10-11
PLAYING VIDEO FILES USING OMBAR DASH CAM .....	12
PLAYING VIDEO FILES USING YOUR SMARTPHONE .....	13-18
MENU .....	19-23
FAQ .....	24-25
NOTICE .....	26-27

## ■ CUSTOMER SERVICE

- 🔊) Defective or damaged item?
- Inaccurate description?
- Missing parts or accessories?
- Performance or quality not adequate?
- Wrong item was sent?



**support@ombars.com**

Response in just 12 hours

Contact us before returning the item.  
We will help you resolve any issue asap.

## ■ INTRODUCTION

Thank you for purchasing this OMBAR dashcam.

This instruction manual contains information on how to operate your dash cam. Before using your dashcam, we recommend that you read through this manual to ensure correct usage.

To improve the performance of the product, the contents of this manual are subject to change without prior notice.



### **Note:**

1. MicroSD card is not included in the package. Be sure to format your SD card with your dash cam for the first time use.
2. Please ALWAYS connect with power when using. As it is built in super capacitor (Only has a 1mAh lithium metal battery used to memorize time).

## ■ IN THE BOX

Check the box for each of the following items before installing the dash cam.

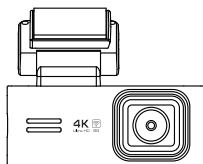

Front Camera ×1

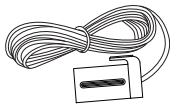

Rear Camera  
(6m/20ft) ×1

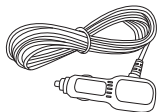

Type-C USB Power  
Cable (3.5m/12ft) ×1

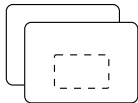

Electrostatic  
Films ×4



Cable Clips ×5  
Pry Tool ×1

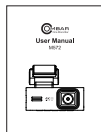

User Manual ×1



### Note:

1. To improve the performance of the product, the contents of this manual are subject to change without prior notice.

## ■ SPECIFICATION

Model Name	M572
Screen Size	3.18 Inch
Aperture	F=1.8
Color	Cool Gery
Language	English/Deutsch/Français/日本語 Español/Русский/简体中文/繁體中文
Video Format	MP4
Photo Format	JPG
Video Code	H.264(Default)/H.265
Video Resolution	Front Cam: 4K 3840*2160 2K 2560*1440 1080P 1920*1080  Front + Rear Cam: 4K+ 1080P 2K+ 1080P 1080P+ 1080P
G-sensor	Built-in 3-Axis Acceleration Sensor
Loop Recording	Support

Timelapse Record	Support (1frame per second, fast video playback)
WiFi/Application	Support 2.4GHz/5GHz
Parking Mode	Support (ONLY works when the dash cam is connected to 3-Lead Hardwire Kit)
Memory	Max support 256GB (Class 10, U3 Speed. microSD card not included in the package)
Microphone	Built-in
Speaker	Built-in
Battery	Built-in Super Capacitor (Only has a 1 mAh lithium metal battery used to memorize time)
Power Interface	5V/2.5A
Working Temperature	-20°C to 70°C (-4°F to 158°F)



**Note:**

1. Please only use OMBAR car charger in this package.
2. Please ALWAYS connect with power when using. As it is built in super capacitor (Only has a 1mAh Lithium Metal Battery used to memorize time).
3. We ONLY recommend use OMBAR's SD cards for optimal performance.  
Using third party or unqualified SD cards can affect dashcam's performance and in some cases, force the dashcam to reboot randomly during recording.

## ■ PRODUCT DIAGRAM

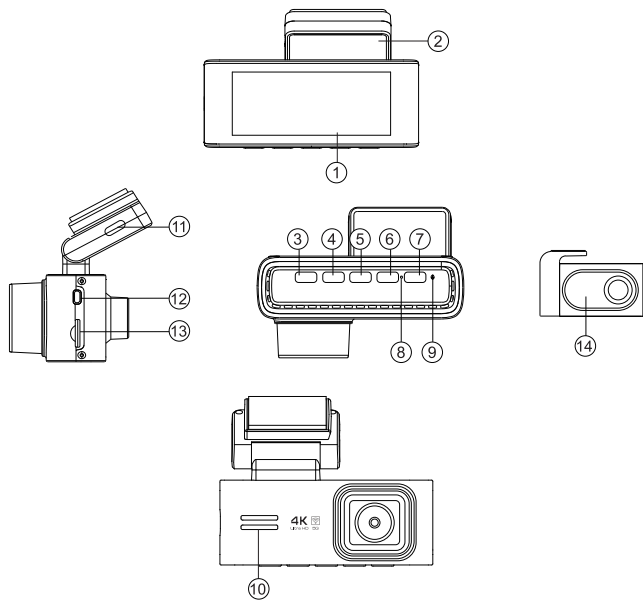





① Screen	② Mounting Bracket	③ Power	④ UP
⑤ OK	⑥ Down	⑦ Mode	⑧ Mic
⑨ Reset	⑩ Speaker	⑪ Type-C Charging Port	
⑫ Rear Camera Connection Port		⑬ SD Card Slot	
⑭ Rear Camera			

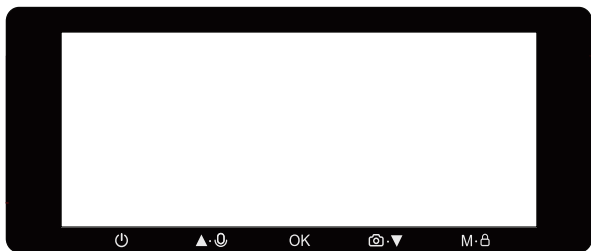

## ■ BUTTONS AND FUNCTIONS



Key	Functions
	<ol style="list-style-type: none"><li>1. Press once while the camera is OFF-Turn ON the camera</li><li>2. Press and hold while the camera is ON-Turn OFF the camera</li><li>3. Press once while the camera is ON-Turn OFF/ON LCD screen, please note that it is still working</li></ol>
	<ol style="list-style-type: none"><li>1. Press once while the camera is recording-shift camera display mode</li><li>2. Press and hold-Turn OFF/ON audio recording</li></ol>
OK	<ol style="list-style-type: none"><li>1. Press once-start/stop video recording</li><li>2. Press once-play/pause video while in playback mode</li><li>3. Press once-enter/confirm specific settings while in menu settings</li></ol>
	<ol style="list-style-type: none"><li>1. Press once-take photo</li><li>2. Press and hold-Turn ON/Turn OFF WiFi</li></ol>
M 	<ol style="list-style-type: none"><li>1. Press once while the camera is recording-lock the video</li><li>2. Press once while the camera is unrecording-enter/quit menu settings</li><li>3. Press and hold while the camera is unrecording-enter/quit playback settings</li></ol>

## ■ INSTALLATION

Install the front camera at the top of the front windshield. Remove any foreign matter and clean and dry the windshield before installation. Install the rear camera at the top of the rear windshield.

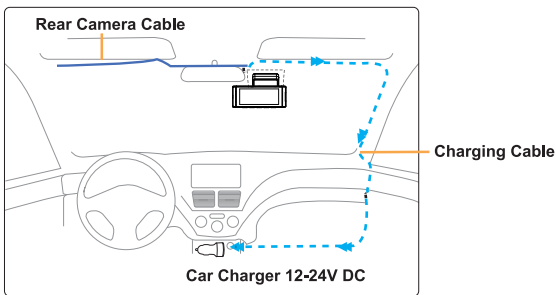

1. Correctly connect the magnetic bracket and M572 dash cam through the strong magnetic attraction.
2. Insert the microSD card into the microSD slot of the dash cam and format your SD card for the first time use.
3. Stick the electrostatic film on your windshield, then stick the magnetic bracket on top of the electrostatic film.
4. Turn off the car engine.
5. Connect the charging cable to the Type-C port of the magnetic bracket. Use the pry tool to lift the edges of the windshield trim/molding and tuck in the power cord.
6. Adjust the angle of the lens by the bracket of the front camera. We recommend pointing the lens slightly downwards ( $\approx 10^\circ$  below horizontal), so as to record video with a 6:4 road to background ratio.
7. Turn on the engine. The dashcam will power up and start recording. Video files are stored on the microSD card. When the microSD card fills up, the newest video files will start to replace the oldest video files (called loop recording) – so you will always have the most recent video files.

8. Peel off the protective film from the double-sided tape and attach the rear camera to the rear windshield. Adjust the angle of the lens by rotating the body of the rear camera, connect the front camera and the rear camera.

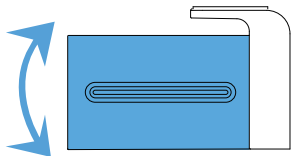

9. Use the pry tool to lift the edges of the rubber window sealing and molding and tuck in the rear camera connection cable.

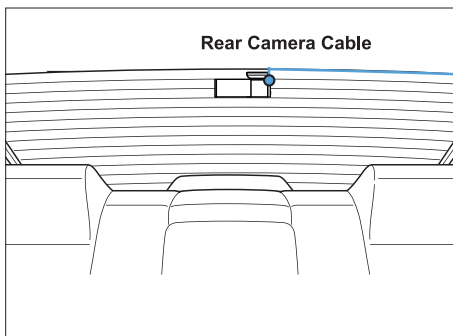

10. Plug the cigarette lighter power cable into the cigarette lighter socket and the front camera. Use the pry tool to lift the edges of the windshield trim/molding and tuck in the power cord.

**Note:** The length of original cable for rear camera is 6m/20ft, suitable for most types of cars.

## ■ USING OMBAR DASH CAM

The camera is designed to power up and record automatically when it receives power. Then saves the video record and turns off automatically when the car shuts off.

### 1. Auto Power ON/OFF:

- ① Plug car charger to cigarette lighter socket.
- ② When the car engine is on, dash cam will turn ON and start recording automatically.

When the car key is turned to LOCK position, dash cam automatically saves the recording and turns OFF.

### 2. Manual Power ON/OFF

Manually Turn ON: Press the power button once.

Manually Turn OFF: Press and hold the power button for at least 2 seconds.



### Note:

1. Do not remove or insert rear camera when the camera is powered on which may damage the camera. It is to improve stability that the dashcam reboots automatically once if it detects that there are different cameras connected.
2. Please ALWAYS connect with power when using. As it is built in super capacitor (Only has a 1mAh lithium metal battery used to memorize time).
3. Some trucks/cars's 12V cigarette outlet is always HOT, which means it provides constant power even when the car is turned off and locked. If this is the case for your vehicle, then the auto ON/OFF feature will not work. And if you leave the camera continuously recording when the car is turned off, then it will drain your car/truck's battery and you might not have enough power to start your car for next time. To remedy this situation, you can do one of the two options:
  - ① Hardwire your dash cam to your car's fuse box with 3-lead auto trigger hardwire kit.
  - ② Change the connection in the fuse box for your 12V outlet to socket which only supplies power when car key is turned to ACC or ON position.

## First Time Use

This menu is used to set your preferred language, time zone, date & time and format memory card. Press the OK button to enter the next step.

This menu will appear when:

1. The dash cam is first turned on.
2. There has been a Firmware Update.
3. After the dash cam's settings have been reset, by using the "Default Setting" option in the system settings.

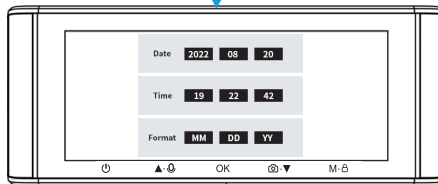
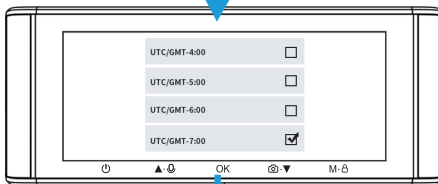

## ■ PLAYING VIDEO FILES USING OMBAR DASH CAM

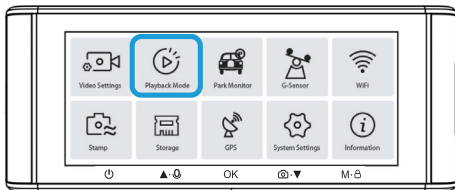

Press the "M" button to access the Menu settings. And then choose the "Playback Mode" to go to the Playback Mode.

**Normal:** The dashcam records in normal loop recording mode or timelapse loop recording mode.

**Event:** When the dashcam detects an impact while in normal loop recording mode, it switches to emergency recording mode and saves a locked video of 1min which is triggered 5 seconds before the event.

**Parking:** When the dashcam detects an impact while parking mode, it switches to emergency recording mode and saves a locked video of 1min which is triggered 5 seconds before the event.

**Picture:** It will save a picture when taking a picture by pressing the down button of the dashcam once.



## ■ PLAYING VIDEO FILES USING YOUR SMARTPHONE

### Check real-time video using your smartphone

1. Search for the Oncam APP in the Google Play store or apple APP store and install it on your smartphone.



2. Turn on WiFi of the dash cam: Press and hold down button to turn on the WiFi mode. Scan the QR code to get the whole process about WiFi.
3. Turn on WiFi of your phone and connect: Go to Phone's Settings > WiFi > Select WiFi of the dashcam. After it's connected to the WiFi, it will say "No Internet Connection" which was normal. Because dash cam WiFi is ONLY for video/photo transfer function, NOT made to broadcast footage over the cloud or internet, please ignore the prompt.

**WiFi Name SSID: M572\*\*\*\*\***

**Default PASSWORD: 12345678**



**Note:**

M572 is built in 2.4GHz and 5GHz Dual-frequency WiFi module. If your phone can't search M572 WiFi, it means your phone ONLY support 2.4GHz band, please shift to 2.4GHZ on the menu.

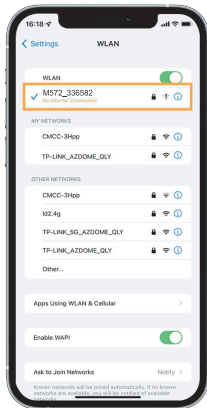

#### 4. Open the Oncam APP

Now you can view in real-time the video currently being recorded by connecting your smartphone to the dashcam via WiFi direct.

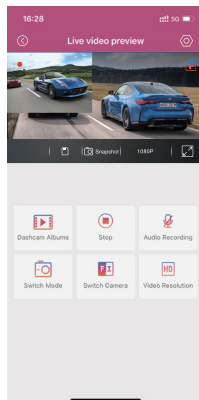
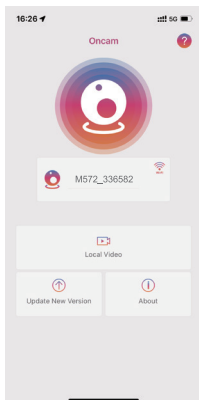



## Download the video files into your smartphone

1. Go to dashcam preview interface. Please STOP recording first, then press the "Dashcam Albums" to get photo, video, emergency files.

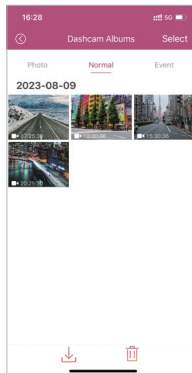
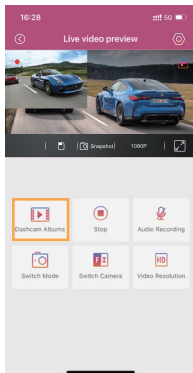

2. Select the video files to download into your phone, then you can find these downloaded video files in APP original interface menu named "Local Video". However, it will take a bit of time to download one video file.

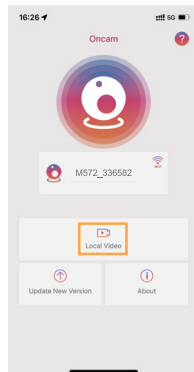
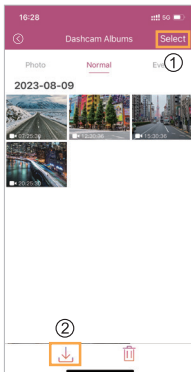

## Note:

1. You can't operate the dash cam when your phone is connected to WiFi.
2. WiFi direct lets you directly connect your smartphone to your dash cam via WiFi within a range of 25FT.

### The aPP won't show the live video on your phone. It only shows a picture?

The cellular data will cause the live video not to be viewed. If the APP won't show the live video, please disable the "Oncam" cellular data of your phone. Sure that the Local Network of the "Oncam" is turned on.

- ① For Latest iOS System: Setting > Oncam > Click "Wireless Data" > Select "WLAN"
- ② For Older iOS System: Setting > Oncam > Disable the "Cellular Data".

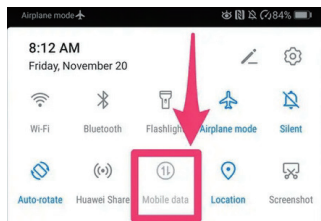
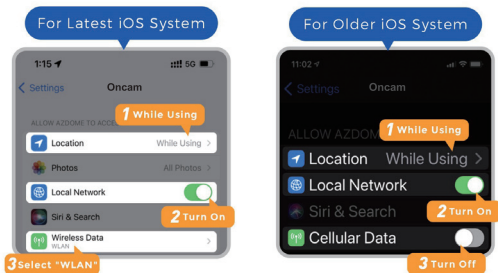

## What is a WiFi Feature?

The WiFi feature has been designed so you can pair your dash camera wirelessly with your smartphone and access your recording instantly from the dash cam. Here you can view, download and share your videos easily with your friends and family. Just like how you would connect your bluetooth speaker to your smartphone for wireless music play, the same way dash cameras use WiFi signal (instead of a bluetooth) to pair your smartphone with oncam M572.

## Can I watch the videos around my car remotely?

NO. OMBAR M572 dash cam is NOT made to broadcast footage over the cloud or internet. It is NOT a cloud or an IP camera and it is NOT meant to do that. You can get live video and footage on oncam dash cam's APP as long as you stay within the 25FT range from the dashcam.

## What is the WiFi Range?

The WiFi signal range is about 25FT when there are NO obstructions in the middle. Please NOTE that just like your home WiFi network, you don't have WiFi signal outside your home, the same way, WiFi range is 25FT from this small device.

## For iPhone:

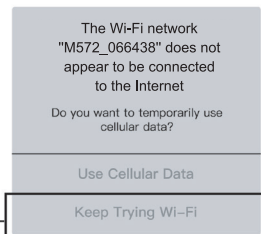

If you get this pop up for your iPhone while using WiFi feature, make sure to tap on "Keep Trying WiFi". Otherwise the camera will get disconnected from the WiFi and then you will have to forget the oncam WiFi and then start to pair again to make it work again.

## For Android phones:

When installing the oncam APP, it will have two pop-up prompts, select "While using the APP" to allow oncam to access this device's location, and "select Allow" to allow oncam to access photos and media on your device.

There is one extra step you will have to take for the first time. Once you connect to the WiFi of M572, it will say "No Internet". Which is fine. Wait about 10-15 seconds until you see the below pop up or notification.

You just have to tap on the pop up notification that will show up in few seconds to select that you still want to stay connected even though there is NO Internet. Once you select this OK, you are set to go.

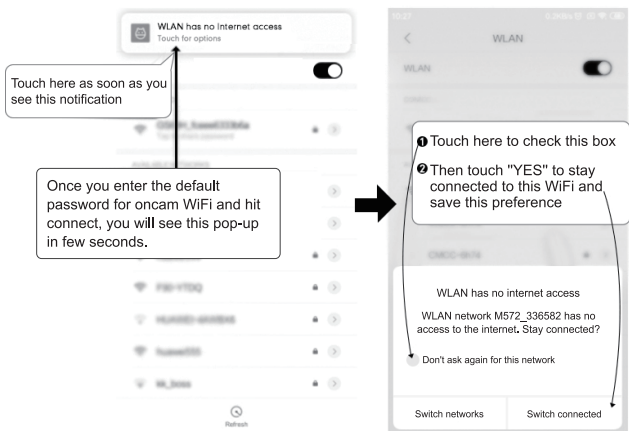

## ■ MENU



### 1. Video Settings

#### Video Resolution

Allow to choose the video resolution.

#### Loop Record—1min(default) / 2mins / 3mins

Here select the length (1/2/3 min) of each video clip for the loop recording. This function allows the dash cam to continuously record. Please notice: The dash cam will keep deleting the oldest files automatically when memory card gets full so that it can keep recording over and over.

#### Audio Recording—On(default) / Off

Turn On/Off the microphone for video recording.

#### Light Frequency—50Hz / 60Hz(default)

According to the power supply specification used in your country.

60Hz-Used in USA, North America

50Hz-Used in Europe, most Asian Countries.

## 2. Playback Mode

Normal: It's the video files that are saved in normal loop recording mode. Event: It's the video files that dashcam locks when the car's shocked.

Parking: It's the video files that dashcam locks when the car's shocked when parking.

Photo: It's the picture files that are taken.

## 3. Parking Monitor—Off(default) / Time-Lapse 1fps / Collision

This function will ONLY work when 3-lead hardwire kit is installed properly, the output current of hardwire kit needs to reach 2.5A.

Then select [Connected] and select parking mode. This parking mode has two options to choose from.



### Note:

1. OMBAR's custom-designed 3-Lead Hardwire Kit is required to use this new feature. Not included in the packaging, Please search:  
Asin: B0BNPWTSBH

### \*Time-Lapse 1fps Parking Mode:

1. When you turn OFF the car's engine and turn the key to the lock position. Then the camera will STOP the continuous video recording and it will go into the timelapse 1fps recording mode automatically.
2. Now while this timelapse is being recorded, if someone hits your car and if the impact reaches the set G-Sensor level, then the camera will start to record 1min continuous video, save & lock that video in Parking folder > then return to the timelapse 1fps recording.
3. Now when you start your car for the next time, the camera will automatically STOP the timelapse parking mode. Then it will go into normal video mode automatically to start the continuous video recording.

### **\*Collision Parking Mode:**

1. When you turn OFF the car's engine and turn the key to the lock position. Then the camera will STOP the continuous video recording and it will go into the impact detection mode and the camera will turn OFF.
2. Now while the camera stays in impact detection mode, if someone hits your car and if the impact reaches the set G-Sensor level, then the camera will turn ON > then it will start to record 1min continuous video, save & lock that video in Parking folder > then the camera will turn OFF.
3. Now when you start your car for the next time, the camera will automatically go back into normal video mode automatically to start the continuous video recording.

### **4. G-Sensor—Off / High / Middle(default) / Low**

G-sensor is a 3-axis impact gravitational accelerometer, designed to detect physical and gravitational forces on the dash cam. Once G-sensor has been triggered due to physical or gravitational impact force on the camera, it switches to emergency recording mode and saves a locked video of 1min beginning 5 seconds before the event trigger. The video file will be locked as an emergency file so it won't be deleted by loop cycle function. The higher the G-Sensor sensitivity is, the less force will be needed to trigger automatic file protection.

### **5. WiFi—Off(default ) / 2.4G / 5G**

Turn on/off the WiFi of the dash cam.

WiFi Name SSID: M572\*\*\*\*\*

Default PASSWORD: 12345678



#### **Note:**

The oncam is available for devices running Android 5.0 and higher, or iOS 9.0 and higher. You can't operate the dash cam when your phone is connected to WiFi.

## 6. Video Stamp—Off / On(default)

Turn On/Off the Time/License plaste shown on recorded files.

## 7. Micro SD Card

**Format Reminder:** Once chose a time duration and turn on this function, the dash cam will pop up "Please format SD card" to avoid too much locked files to use loop recording.

**Format Memory Card:** The formatting process will make sure that the card's file system format is optimized for the camera. It usually takes 20-30seconds to format the memory card in this dashcam. Note: For stable performance, it is recommended that you format the memory card every 1-2 months.

**Memory Card Storage:** Storage information of memory card can be found here.

## 8. System Settings

### Key Tone—On(default) / Off

To switch on/off or adjust the key tone.

### Speaker Volume—Low(default) / Medium / High

Adjust the volume of the internal speaker.

### Language—Multilingual

Select your preferred language.

Default: Follows your first time use selection.

### Screen Saver—Screen Always On / Screen Saver On After 1 MIN / Off(default) / Screen off After 1 MIN.

**Screen Always On:** It will make the screen always stay ON.

**Screen Saver On After 1 MIN / Off:** It will shut down the screen and show time, date and speed after 1min.

**Screen off After 1MIN:** It will shut down the screen after 1min.



### **Fatigue Driving Reminder—Off(default ) / 2hour / 3hours / 4hours**

Once chose a time duration and turn on this function, the dash cam will make sounds to alert.

### **Date / Time**

Adjust the time & date as required.

Note: Time and date settings will be overwritten upon satellite connection.

### **License Plate**

Allow to definite your license plate, press Up/Down button to choose letter/number, then press [OK] button to confirm, Finally press [M] button to save it.

### **Default Setting**

Reset the dash cam to default settings. Your recordings will not be affected.

## **9. About**

To check the current firmware in the dash cam. You'll need this necessary information to check if newer version firmware is available to update.

## ■ FAQ

### **Q1: Camera turns ON/OFF automatically?**

Ensure that the output current can reach 5V/2.5A and use our car charger. And ensure that the rear camera are connected correctly. It is to improve stability that the dashcam reboots automatically once it detects that there are different cameras connected.

### **Q2: Video Image is blurred?**

Remove the protective lens film, clean the lens, make sure the windshield is clean and clear of grease, dirt, and debris.

### **Q3: Camera gets HOT?**

It is normal for your camera to run slightly hot. Due to video being recorded at high speed, the dash cam may be hot during using. (No more than 158°F/70°C).

### **Q4: No power to my dash cam but it works upon my computer?**

The cigarette power cable is not working. Inspect the fuse in the car power cable plug. If the fuse is found to be blown, inspect the power cable for damage which may have caused the fuse to blow.

### **Q5: Video Files cannot be played on my computer?**

The video files from the Dash Cam are in MP4 format and may not be compatible with your PC if suitable playback software is not installed.

### **Q6: Video has no sound?**

Ensure that "Record Audio" setting is turned ON. Press once the UP Button while the video is recording, and it will Mute the built-in microphone.

Ensure that "Timelapse Record" setting is turned OFF within the Menu.

**Q7: Photograph is blurred?**

The dash cam has a minimum focal range of around 2 meters. Objects closer than this are likely to become blurred. LONG PRESS for 2-Seconds to Take Snap.

**Q8: Camera showing Memory Error?**

Using unqualified SD or third party cards can affect dashcam's performance and in some cases, force the dashcam to reboot randomly during recording. If it still can not work normally, it should be that the TF card is unqualified and can not meet the recording requirements of the dash cam. Please contact us to get a new memory card.

## ■ NOTICE

 This product complies with the radio interface requirements of the European Community.

 This symbol means the product must not be discarded as household waste, and should be delivered to an appropriate and recycling helps protect natural resources, human health and the environment. For more information on disposal and recycling of this product, contact your local municipality, disposal service, or the shop where you bought this product.

 Changes or modifications not expressly approved by the party responsible for compliance could void the user's authority to operate the equipment.

This equipment has been tested and found to comply with the limits for a class B digital device, pursuant to part 15 of the FCC rules. These limits are designed to provide reasonable protection against harmful interference in a residential installation. This equipment generates, uses and can radiate radio frequency energy and, if not installed and used in accordance with the instructions, may cause harmful interference to radio communications. However, there is no guarantee that interference will not occur in a particular installation.

If this equipment does cause harmful interference to radio or television reception, which can be determined by turning the equipment off and on, the user is encouraged to try to correct the interference by one or more of the following measures:

- Reorient or relocate the receiving antenna.
- Increase the separation between the equipment and receiver.
- Connect the equipment into an outlet on a circuit different from that to which the receiver is connected.
- Consult the dealer or an experienced radio/TV technician for help.

This device complies with part 15 of the FCC rules.

Operation is subject to the following two conditions:

(1) this device may not cause harmful interference, and (2) this device must accept any interference received, including interference that may cause undesired operation.

This equipment complies with FCC radiation exposure limits set forth for an uncontrolled environment. This equipment should be installed and operated with a minimum distance of 20cm between the radiator & your body. This transmitter must not be co-located or operating in conjunction with any other antenna or transmitter.