



Invacare® Leo

en **Scooter**
User Manual



This manual **MUST** be given to the user of the product.
BEFORE using this product, read this manual and save for future reference.



Yes, you can.®

© 2014 Invacare® Corporation

All rights reserved. Republication, duplication or modification in whole or in part is prohibited without prior written permission from Invacare. Trademarks are identified by ™ and ®. All trademarks are owned by or licensed to Invacare Corporation or its subsidiaries unless otherwise noted.

Contents

I General	5
1.1 Introduction	5
1.2 Symbols in this manual	5
1.3 Type classification	5
1.4 Intended use	6
1.5 Regulations	6
1.6 Warranty	6
1.7 Service life	6
2 Safety	7
2.1 General safety notes	7
2.2 Safety information on electromagnetic interference	8
2.3 Safety information on driving and freewheel mode	9
2.4 Safety information with regard to care and maintenance	11
2.5 Labels on the product	11
3 Components	13
3.1 Main parts of the scooter	13
3.2 Operating console arrangement	13
3.2.1 Status Display	14
3.2.2 Battery charge display	14
4 Accessories	15
4.1 Postural belts	15
4.1.1 Types of postural belts	15
4.1.2 Adjusting the postural belt correctly	15
4.1.3 Installing the Seat Positioning Strap	15
4.2 Rollator bracket	16
4.2.1 Attaching the rollator	16
4.2.2 Removing the rollator bracket	17
4.2.3 Positioning the rear reflector	17

5 Setup	19
5.1 Adjusting the Armrest Width	19
5.2 Adjusting the armrest angle	19
5.3 Replacing Armrest Pad	19
5.4 Adjusting the Seat Position Forward/Rearward	20
5.5 Removing/Installing the seat	20
5.6 Adjusting 90° Seat Swivel	20
5.7 Adjusting the Tiller Angle	21
5.8 Adjusting Seat Height	22
5.9 Activating/Deactivating the Audible Signals	22
6 Usage	24
6.1 Getting in and out	24
6.2 Before driving for the first time	25
6.3 Taking Obstacles	25
6.3.1 Maximum obstacle height	25
6.3.2 Safety information when ascending obstacles	25
6.3.3 The correct way to overcome obstacles	25
6.4 Driving up and down gradients	25
6.5 Parking and stationary	26
6.6 Use on public roads	26
6.7 Pushing the scooter by hand	26
6.7.1 Disengaging motors	26
6.8 Driving the scooter	27
7 Electrical system	28
7.1 Electronics protection system	28
7.1.1 The main fuse	28
7.2 Batteries	28
7.2.1 General information on charging	28
7.2.2 General instructions on charging	28
7.2.3 How to charge the batteries	29
7.2.4 How to disconnect the batteries after charging	30
7.2.5 Storage and Maintenance	30

7.2.6	Instructions on using the batteries	30
7.2.7	Transporting batteries	31
7.2.8	General instructions on handling the batteries	31
7.2.9	How to handle damaged batteries correctly	31
7.3	5 A battery charger	32
7.3.1	Symbols found on the product	32
7.3.2	Features	32
7.3.3	LED display	32
7.3.4	Caution	32
7.3.5	Operating instructions	33
7.3.6	Troubleshooting	33
7.3.7	Technical specifications	33
8	Transport	35
8.1	Transport - General information	35
8.2	Transporting the Scooter	35
8.3	Removing/Installing the Batteries	36
9	Maintenance	37
9.1	Maintenance introduction	37
9.2	Cleaning the mobility device	37
9.3	Inspection checks	37
9.4	Repair Instructions	39
9.4.1	Removing/Installing the Drive Wheels	39
9.4.2	Removing/Installing the Front Wheel - Three Wheel Models	40
9.4.3	Removing/Installing the Front Wheels - Four Wheel Models	40
9.4.4	Repairing tire punctures (pneumatic tires of type 10")	41
10	After Use	43
10.1	Disposal	43
11	Troubleshooting	44
11.1	Diagnosis and fault repair	44

11.1.1	Error diagnosis	44
11.1.2	Error codes and diagnostic codes	44
12	Technical data	47
12.1	Technical specifications	47

I General

I.1 Introduction

Thank you for choosing an Invacare product.

This user manual contains important information about the handling of the product. In order to ensure safety when using the product, read the user manual carefully and follow the safety instructions.

Please note that there may be sections in this user manual, which are not relevant to your product, since this manual applies to all existing modules (on the date of printing).

If you find that the font size in the print version of the user manual is difficult to read, you can download it as a pdf from the Invacare website (see back page of this manual). The pdf can then be scaled on screen to a font size that is more comfortable for you.

This mobility device has been constructed for a large circle of users with different requirements.

The decision whether the model is suitable for the user may only be taken by medical specialists with appropriate expertise.

Invacare or their statutory representatives can accept no liability in cases in which the mobility device has not been adapted to suit the users' handicaps.

Some maintenance and settings can be performed by the user or his/hers attendants. Certain adjustments do however require technical training and may only be carried out by your Invacare specialist dealer. Damages and errors caused by nonobservance of the user manual or as a result of incorrect maintenance are excluded from all guarantees.

I.2 Symbols in this manual

In this user manual warnings are indicated by symbols. The warning symbols are accompanied by a heading that indicates the severity of the danger.



WARNING

Indicates a hazardous situation that could result in serious injury or death if it is not avoided.



CAUTION

Indicates a hazardous situation that could result in minor or slight injury if it is not avoided.



IMPORTANT

Indicates a hazardous situation that could result in damage to property if it is not avoided.



Gives useful tips, recommendations and information for efficient, trouble-free use.



This product complies with Directive 93/42/EEC concerning medical devices. The launch date of this product is stated in the CE declaration of conformity.

Requirements:



This symbol identifies a list of various tools, components and items which you will need in order to carry out certain work. Please do not attempt to carry out the work if you do not have the listed tools available.

I.3 Type classification

This vehicle has been classified according to EN 12184 as a **class B mobility product** (for indoor and outdoor areas). It is therefore

compact and agile enough for indoor areas, but also able to overcome many obstacles in outdoor areas.

1.4 Intended use

This vehicle was designed for persons whose ability to walk is impaired, but who are still in terms of their eyesight and physically and mentally able to operate an electric vehicle.

1.5 Regulations

The vehicle was successfully tested according to German and international standards as to its safety. It satisfies the requirements according to RoHS 2011/65/EU, REACH 1907/2006/EC and DIN EN 12184 including EN 1021-1/-2. It was also tested successfully according to EN 60529 IPX4 as to its resistance to spray water, and is therefore well suited for weather conditions such as typical European weather conditions. When equipped with an appropriate lighting system, the vehicle is suitable for use on public roads.

1.6 Warranty

The terms and conditions of the warranty are part of the general terms and conditions particular to the individual countries in which this product is sold.

1.7 Service life

We estimate a service life of five years for this product, provided it is used in strict accordance with the intended use as set out in this document and all maintenance and service requirements are met. The estimated service life can be exceeded if the product is carefully used and properly maintained, and provided technical and scientific advances do not result in technical limitations. The service life can also be considerably reduced by extreme or incorrect usage. The fact that we estimate a service life for this product does not constitute an additional warranty.

2 Safety

2.1 General safety notes

**WARNING!**

Risk of injury if mobility device is used in any other way than the purpose described in this manual

- Only ever use the mobility device in accordance with the instructions in this user manual.
- Pay strict attention to the safety information.

**WARNING!**

Risk of injury if the scooter is driven when your ability to drive is impaired by medication or alcohol

- Never drive any vehicle under the influence of medication or alcohol.

**WARNING!**

Risk of damage or injury if the scooter is accidentally set into motion

- Switch the power system off before you get in, get out or handle unwieldy objects.
- Be aware that the motor brakes are automatically deactivated when the motors are disengaged. For this reason, freewheel operation is only recommended on flat surfaces, never on gradients. Never leave your scooter on a gradient with its motors disengaged. Always re-engage the motors immediately after pushing the scooter.

**WARNING!**

Risk of injury if the power is switched off while the scooter is in motion, due to it coming to an abrupt, sharp stop

- If you have to brake in an emergency, simply release the drive lever and allow the scooter to come to a complete stop.
- If fitted, pull the handbrake until the scooter comes to a stop.
- Only switch the scooter off while in motion as a last resort.

**WARNING!**

Risk of injury if the scooter is transported in another vehicle with the occupant seated in it

- Never transport the scooter with the occupant seated in it.

**WARNING!**

Risk of injury if you fall off the scooter

- If restraining systems are installed (such as seat belts), use them each time you drive the scooter.



CAUTION!

Risk of injury if maximum permissible load is exceeded

- Do not exceed the maximum permissible load (refer to 12 Technical data, page 47).
- The mobility device is only designed for use by a single occupant whose maximum weight does not exceed the maximum permissible load of the device. Never use the mobility device to transport more than one person.



CAUTION!

Risk of injury due to wrong lifting or dropping of heavy components

- When maintaining, servicing or lifting any part of your mobility device, take into account the weight of the individual components especially the batteries. Be sure at all times to adopt the correct lifting posture and ask for assistance if necessary.



CAUTION!

Risk of injury by moving parts

- Make sure that no injury is incurred by moving parts of the scooter, like wheels or a seat lifter (if fitted), especially when children are around.



CAUTION!

Risk of injury from hot surfaces

- Do not leave the mobility device in direct sunlight for prolonged periods. Metal parts and surfaces such as the seat and armrests can become very hot.



CAUTION!

Risk of technical failure and injury if unauthorized spare parts and components are used

- Only use original Invacare spare parts, which have been approved for use with this mobility device.



CAUTION!

Risk of fire or breaking down due to electric devices being connected

- Do not connect any electric devices to your mobility device that are not expressly certified by Invacare for this purpose. Have all electrical installations done by your authorized Invacare dealer.

2.2 Safety information on electromagnetic interference

This electric vehicle was successfully tested in accordance with International standards as to its compliance with Electromagnetic Interference (EMI) regulations. However, electromagnetic fields, such as those generated by radio and television transmitters, and cellular phones can influence the functions of electric vehicles. Also, the electronics used in our vehicles can generate a low level of electromagnetic interference, which however will remain within the tolerance permitted by law. For these reasons we ask you to please observe the following precautions:



WARNING!

Risk of malfunction due to electromagnetic interference

- Do not switch on or operate portable transceivers or communication devices (such as radio transceivers or cellular phones) when the vehicle is switched on.
- Avoid getting near strong radio and television transmitters.
- In case the vehicle should be set in motion unintentionally or the brakes are released, switch it off immediately.
- Adding electrical accessories and other components or modifying the vehicle in any way can make it susceptible to electromagnetic interference. Keep in mind that there is no sure way to determine the effect such modifications will have on the overall immunity of the electronic system.
- Report all occurrences of unintentional movement of the vehicle, or release of the electric brakes to the manufacturer.

2.3 Safety information on driving and freewheel mode



WARNING!

Risk of injury if the mobility device tips over

- Only ever negotiate gradients up to the maximum safe slope and only with the backrest in an upright position, and the seat lifter in the lowest position (if installed).
- Only ever drive downhill at a maximum of 2/3 of the top speed. Avoid abrupt braking or accelerating on gradients.
- If at all possible, avoid driving on wet, slippery, icy, or oily surfaces (such as snow, gravel, ice etc.) where there is a risk of you losing control over the mobility device, especially on a gradient. This may include certain painted or otherwise treated wood surfaces. If driving on such a surface is inevitable, then always drive slowly and with the utmost caution.
- Never attempt to overcome an obstacle when on an uphill or downhill gradient.
- Never attempt to drive up or down a flight of steps.
- Always approach obstacles straight on. Ensure that the front wheels and rear wheels move over the obstacle in one stroke, do not stop halfway. Do not exceed the maximum obstacle height (refer to 12 Technical data, page 47).
- Avoid shifting your center of gravity as well as abrupt changes of direction when the mobility device is in motion.



WARNING!

Risk of injury if the mobility device tips over (continued)

- Never use the mobility device to transport more than one person.
- Do not exceed the maximum permissible load.
- When loading the mobility device, always distribute the weight evenly. Always try to keep the center of gravity of the mobility device in the middle, and as close to the ground as possible.
- Note that the mobility device will brake or accelerate if you change the driving speed while it is in motion.



WARNING!

Risk of injury if you collide with an obstacle when driving through narrow passages such as doorways and entrances

- Drive through narrow passages in the lowest driving speed and with due caution.



WARNING!

The center of gravity of the scooter is higher than that of a power wheelchair.

- There is an increased tipping risk when negotiating bends.
- Reduce speed before negotiating bends. Only accelerate when you have come out of the bend.



WARNING!

Risk of tipping

Antitippers (stabilizers) are only effective on firm ground. They sink in on soft ground such as grass, snow or mud if the mobility device rests itself on them. They lose their effect and the mobility device can tip over.

- Only drive with extreme care on soft ground, especially during uphill and downhill journeys. In the process pay increased attention to the tip stability of the mobility device.

2.4 Safety information with regard to care and maintenance



DANGER!

Risk of death, serious injury, or damage

Incorrect repair and/or servicing of this mobility device performed by users/caregivers or unqualified technicians can result in death, serious injury, or damage.

- DO NOT attempt to carry out maintenance work that is not described in this user manual. Such repair and/or service MUST be performed by a qualified technician. Contact a dealer or Invacare technician.



CAUTION!

Risk of accident and loss of warranty if maintenance is insufficient

- For reasons of safety and in order to avoid accidents which result from unnoticed wear, it is important that this mobility device undergoes an inspection once every year under normal operating conditions (see inspection plan contained in service instructions).
- Under difficult operating conditions such as daily travel on steep slopes, or in the case of use in medical care cases with frequently changing mobility device users, it would be expedient to carry out intermediate checks on the brakes, accessories and running gear.
- If the mobility device is to be operated on public roads, the vehicle driver is responsible for ensuring that it is in an operationally reliable condition. Inadequate or neglected care and maintenance of the mobility device will result in a limitation of the manufacturer's liability.



2.5 Labels on the product







1		<p>Identification label sticker on the seat post.</p> <p>For details see below.</p>
2		<p>European representative label on the seat post</p>
3		<p>This product has been supplied from an environmentally aware manufacturer. This product may contain substances that could be harmful to the environment if disposed of in places (landfills) that are not appropriate according to legislation.</p> <p>For details see below.</p>

		Battery label under the cover at the rear
4		<p>Identification of the position of the coupling lever for driving and push operation.</p> <p>For details see below.</p>

Explanation of symbols on labels

	<p>This symbol indicates the “Drive” position of the coupling lever. In this position the motor is engaged and the motor brakes are operational. You can drive the mobility device.</p>
	<p>This symbol indicates the “Push” position of the coupling lever. In this position the motor is disengaged and the motor brakes are not operational. The mobility device can be pushed the wheels turn freely.</p> <ul style="list-style-type: none"> • Note that the remote must be switched off. • Also note the information provided in section 6.7 Pushing the scooter by hand, page 26.
	Date of manufacture

	This product complies with Directive 93/42/EEC concerning medical devices. The launch date of this product is stated in the CE declaration of conformity.
	The product needs to be tied down at indicated anchor points with a lashing system during transport.
	This product may not be used as a vehicle seat.
	<ul style="list-style-type: none"> • The 'crossed out wheelie bin' symbol is placed on this product to encourage you to recycle wherever possible. • Please be environmentally responsible and recycle this product through your recycling facility at its end of life.

3 Components

3.1 Main parts of the scooter



- (A) Operating console
- (B) Lever for adjusting tiller inclination
- (C) Keyswitch (ON/OFF)
- (D) Unlocking lever for swivelling and removing seat (left below seat)
- (E) Unlocking lever for sliding seat rails (front right below seat)
- (F) Disengaging lever

3.2 Operating console arrangement

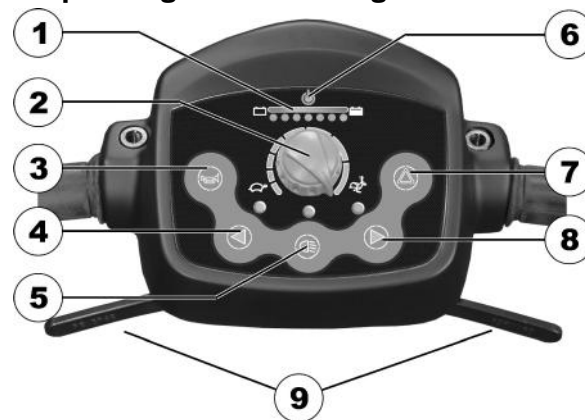

- 1 Battery charge display
- 2 Speed controller
- 3 Horn
- 4 Left-hand direction indicator (switches itself off automatically after 30 seconds)
- 5 Lighting
- 6 Status display
- 7 Warning blinker
- 8 Right-hand direction indicator (switches itself off automatically after 30 seconds)
- 9 Drive lever

3.2.1 Status Display



The ON/OFF diode is used as a fault display (status display). It will flash if there is a problem with the scooter. The number of flashes indicates the type of error. Refer to 11.1.2 Error codes and diagnostic codes, page 44.

3.2.2 Battery charge display

- All diodes illuminate: maximum driving range
- Only red and yellow diodes illuminate: reduced driving range. Recharge the batteries at the end of your journey.
- **Only red LEDs illuminate/blink, electronic beeps 3x: battery reserve = severely restricted driving range. Recharge batteries immediately!**



Overdischarge protection: after a certain drive time on reserve battery power the electronics system switches the drive off automatically and brings the Scooter to a standstill. If you do not drive your Scooter for a while the batteries will "recuperate" and allow a further, but short, journey. However, after a very brief journey the red diodes will illuminate again and the electronic system will beep three times. This procedure leads to battery damage and should be avoided if possible!

4 Accessories

4.1 Postural belts

A postural belt is an option which can either be fixed to the mobility device ex-works or can be retrofitted by your specialist dealer. If your mobility device is fitted with a postural belt, your specialist dealer will have informed you about fitting and usage.

The postural belt is used to help the mobility device user keep an optimum sitting position. Correct use of the belt assists the user in sitting securely, comfortably and well-positioned in the mobility device, especially for such users who do not have such a good sense of balance while sitting.



We recommend using the postural belt whenever the mobility device is used. The belt should be tight enough to ensure that you are sitting comfortably and that your body is in the correct sitting position.

4.1.1 Types of postural belts

Your mobility device can be fitted with the following postural belt types ex-works. If your mobility device has been fitted with a different belt to those listed below, please ensure that you have received the manufacturer's documentation with regard to correct fitting and use.

Belt with metal buckle, adjustable one side



Belt can only be adjusted on one side which can result in the buckle not sitting centrally.

1506942-P

4.1.2 Adjusting the postural belt correctly

1. Ensure that you are sitting correctly, which means that you are sitting right at the back of the seat, your pelvis is positioned erect and as symmetrically as possible, not to the front, to the side or at one edge of the seat.
2. Position the postural belt so that your hipbones can be easily felt above the belt.
3. Adjust the belt length using one of the adjustment aids described above. The belt should be adjusted so that you can fit a flat hand between the belt and your body.
4. The buckle should be positioned as centrally as possible. In doing so, carry out adjustments on both sides as much as possible.
5. Check your belt every week to ensure that it is still in good working condition, to ensure it has no damage or wear, and that it is fixed properly to the mobility device. If the belt is only fastened with a bolted connection, ensure that the connection has not loosened or come undone. You can find more information about maintenance work on belts in the service manual, which is available from Invacare.

4.1.3 Installing the Seat Positioning Strap



Tools:

- 12 mm open-ended spanner
- 13 mm open-ended spanner

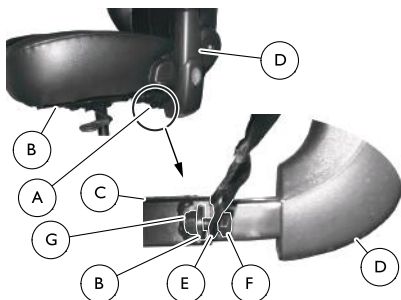

1. Locate the mounting bracket **A** below the seat **B** on the seat frame **C** near the armrest **D**.
2. Secure one side of the seat positioning strap **E** to the mounting bracket using the bolt **F** and nut **G**.

i The nut should go towards the center of the scooter.

3. Repeat steps 1-2 on the opposite side of the seat with the remaining side of the seat positioning strap.

4.2 Rollator bracket

Your scooter can be fitted with an optional rollator bracket. Only the following rollators, which have been approved by Invacare, can be transported using this bracket:

- Dolomite Jazz 600
- Dolomite Legacy 600
- Invacare Banjo P452E/3

The maximum permitted rollator weight is 9 kg.



CAUTION!

Risk of tipping as a result of altered center of gravity

The center of gravity of the scooter shifts towards the back as a result of attaching the rollator. The maximum safe angle of incline is thereby reduced by up to 2°.

- Note that gradients that you would normally be able to negotiate may now be too steep and the scooter could tip. Do not attempt to climb or descend such gradients.

4.2.1 Attaching the rollator

Dolomite Jazz 600

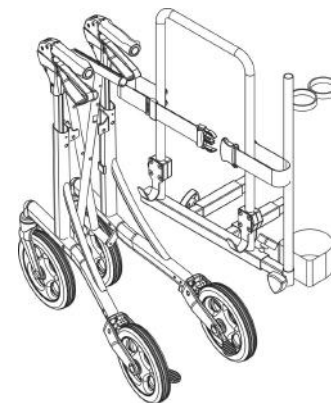

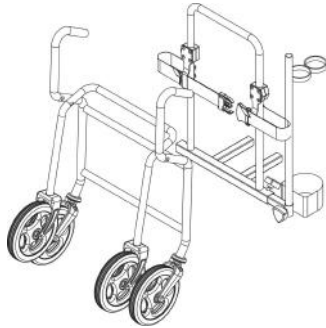
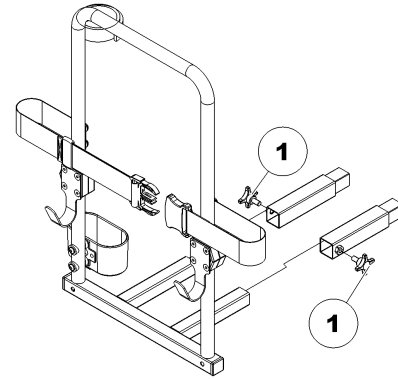
Dolomite Legacy 600**Invacare Banjo P452E/3****4.2.2 Removing the rollator bracket**

1. Loosen the screws (1).
2. Pull the rollator bracket out of the fixtures.

4.2.3 Positioning the rear reflector**CAUTION!****Risk of accident due to poor visibility**

If you wish to use your wheelchair on public roads and a rear reflector is required by national legislation, then the rollator bracket may not cover the rear reflector.

- Make sure that the rear reflector is mounted in such a way that a sufficient amount of the reflective area is visible.

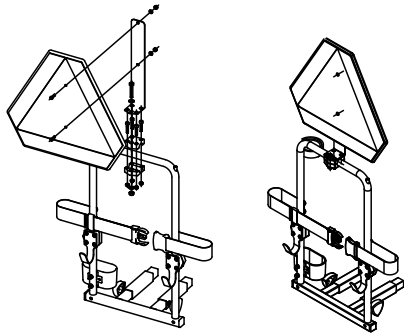

1. Position the rear reflector as shown in the drawing.

5 Setup

5.1 Adjusting the Armrest Width



WARNING!

– Do not pull the armrest tube out of the seat frame beyond the STOP label on the armrest. Otherwise, the armrest tube may fall out of the seat frame and cause injury or damage.



1. Loosen the knob (A) securing the armrest tube (B) to the seat frame (C).
2. Push the armrest in or out to the desired position.
3. Tighten the knob to secure the armrest tube to the seat frame
4. If necessary, repeat STEPS 1–3 to adjust the remaining armrest.

5.2 Adjusting the armrest angle



CAUTION!

Pinch point may occur when adjusting the arm angle

– Pay attention to your fingers.

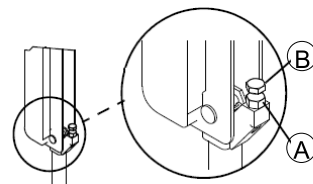

1. Lift up the armrest.
2. Loosen the jam nut (A).
3. Adjust the socket screw (B) up or down to the desired arm angle position.
4. Tighten the jam nut.
5. To determine the same angle for the opposite armrest, count the exposed threads after the jam nut has been tightened.
6. Repeat STEPS 1-4 for opposite armrest, if necessary.

5.3 Replacing Armrest Pad

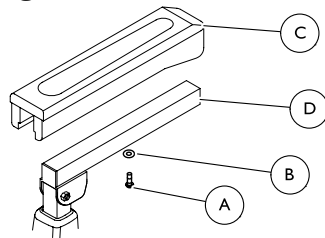

1. Remove the mounting screw (A) and washer (B) that secure the armrest pad (C) to the armrest (D).
2. Remove the old armrest pad.
3. Use the mounting screw and washer to install the new armrest pad. Securely tighten.
4. If necessary, repeat STEPS 1-3 to replace the other armrest pad.

5.4 Adjusting the Seat Position Forward/Rearward

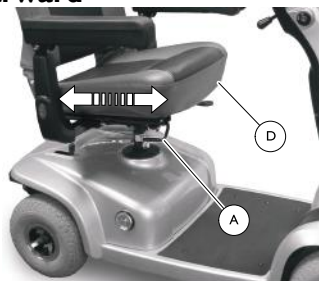

 The seat position lever is located on the right side of the seat.

1. Pull the seat position lever **A** to disengage the seat **B**.
2. Slide the seat forward or rearward into the desired position.
3. Release the lever to lock the seat in position.

5.5 Removing/Installing the seat



WARNING!

Risk of falling from the scooter

– Before use, ensure that the seat is in the locked position. The seat lever must be pulled up all the way to allow the seat to drop into the locked position. Otherwise, a fall from the scooter could occur causing bodily injury and/or damage to the scooter.

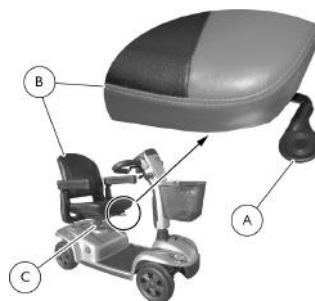

Removing

1. Pull up the seat lock lever **A**.
2. Turn the seat assembly **B** to one side.
3. Hold the seat assembly firmly by the backrest and the front edge of the seat.
4. Lift the seat assembly up and away from the seat post **C**.

Installing

1. Pull up the seat lock lever **A**.
2. Lower the seat assembly **B** onto the seat post **C**.
3. Turn the seat so it faces forward and locks into position.
4. Lift up on seat assembly to ensure the seat is secure.

5.6 Adjusting 90° Seat Swivel



WARNING!

Risk of injury or damage

– Ensure that seat is locked into the forward position before and during operation of the scooter. Otherwise, injury to the user and/or damage to the scooter may result.



Risk of damage

- Use the seat swivel option with caution when accessories are installed (such as safety flag, crutch/cane holder, etc.). Otherwise, damage to the scooter or property may occur.

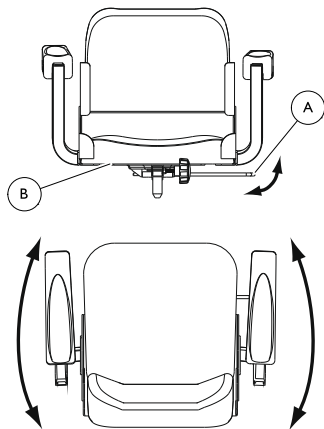

1. Pull up the seat lock lever **A** to unlock the seat **B**.
2. Rotate the seat to the desired position.
3. Release the seat lock lever to lock the seat in the desired position.



Ensure that the seat is locked in the forward facing position before operating the scooter.

5.7 Adjusting the Tiller Angle



WARNING!

Risk of injury or damage

- Before performing any maintenance, adjustment or service, turn power Off and remove key from ignition.
- DO NOT hang items off of the tiller adjustment lever.
- Ensure that tiller is properly adjusted before driving the scooter.
- After making any tiller angle adjustments and before use, the tiller **MUST** be securely locked into position. Otherwise, a fall from the scooter could occur causing bodily injury and/or damage to the scooter. Gently, push/pull against tiller to ensure that the tiller is securely engaged into the adjustment plate.

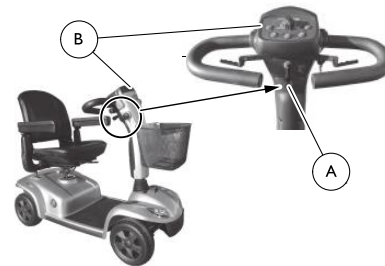

The scooters feature an adjustable tiller. The tiller locks into one of three positions. The tiller can also be folded down for transportation and storage.

1. Pull and hold the tiller adjustment lever **A**.
2. Move the tiller **B** to the desired position.

3. Release the tiller adjustment lever to lock the tiller into the desired position.
4. Gently push/pull against tiller to ensure that the tiller is securely locked.

5.8 Adjusting Seat Height



Tools:

- 2 x 17 mm open-ended spanner

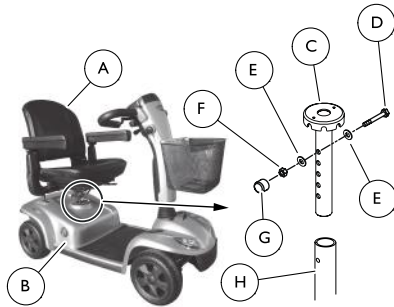

Take note of position and orientation of mounting hardware before removing.

1. Remove the seat (A). Refer to 5.5 Removing/Installing the seat, page 20.
2. Pull up to remove the top shroud (B) and expose the seat post (C) and mounting hardware.
3. Remove the mounting screw (D), two washers (E), locknut (F) and cap (G) that secure the seat post to the frame tube (H).
4. Align the frame tube mounting hole with one of five seat post mounting holes ① to achieve desired seat height.
5. Install one washer onto the mounting screw.
6. Insert the mounting screw through the frame tube and seat post.

7. Install the remaining washer onto the mounting screw.
8. Install the locknut and cap onto the mounting screw to secure the seat post to the frame tube.
9. Install the top shroud.
10. Install the seat. Refer to 5.5 Removing/Installing the seat, page 20.

5.9 Activating/Deactivating the Audible Signals

The scooter system emits an audible signal in the following situations:

- Low Battery Capacity
- Direction Indicators in Use
- Hazard Lamps in Use

The audible signals can be activated or deactivated by pressing the buttons on the control panel (A) in a particular keystroke combination.

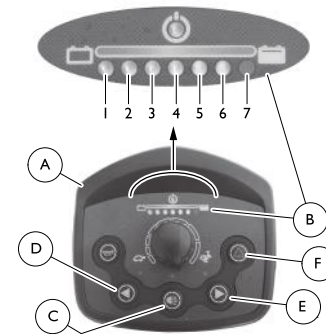

1. Turn the key to the Off position.
2. Press and hold the buttons on the control panel in the keystroke combination shown in the table Audible Signal.
3. Turn the key to the On position.
4. Wait two seconds until the appropriate blink code is displayed on the battery charge display (B), then release the buttons.



DO NOT hold the buttons for more than 5 seconds.

If LED 7 blinks five times the audible signal has been successfully activated.

The scooter will return to normal operating status automatically.

Audible Signal

AUDIBLE SIGNAL	KEYSTROKE COMBINATION	LIT LEADS	CONDITION
Low Battery Capacity	Lighting © + Left Direction Indicator ④	1	Deactivated
		1 + 2	Activated
Direction Indicators	Lighting © + Right Direction Indicator ⑤	3	Deactivated
		3 + 4	Activated
Hazard Lamps	Lighting © + Warning Blinker ⑥	5	Deactivated
		5 + 6	Activated

6 Usage

6.1 Getting in and out

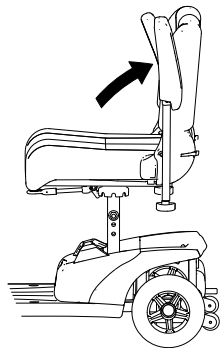

The armrests can be swivelled upwards to assist getting in and out.

The seat can also be rotated to assist getting in and out.

1.

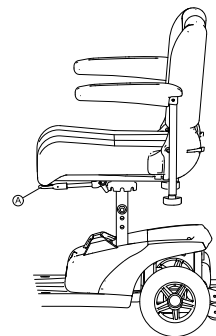

Lift the detent lever **A** up.

2.

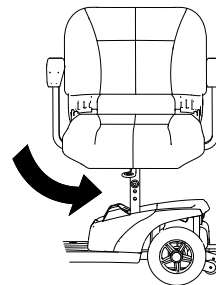

Turn the seat to the side.



Information on turning the seat

– The detent automatically engages again in eighth-turns.

6.2 Before driving for the first time

Before you take your first trip, you should familiarize yourself well with the operation of the vehicle and with all operating elements. Take your time to test all functions and driving modes.



If installed, make sure to properly adjust and use the postural belt each time you use the wheelchair.

Sitting comfortably = Driving safely

Before each trip, make sure that:

- You are within easy reach of all operating controls.
- The battery charge is sufficient for the distance intended to be covered.
- The postural belt (if installed) is in perfect order.
- The rear mirror (if installed) is adjusted so you can look behind at all times without having to bend forward or shift your seating position.

6.3 Taking Obstacles

6.3.1 Maximum obstacle height

You can find information about maximum obstacle heights in the chapter entitled 12 Technical data, page 47.

6.3.2 Safety information when ascending obstacles



WARNING!

Risk of tipping over

- Never approach obstacles at an angle but at 90 degrees as shown below.
- Put your backrest into an upright position before climbing an obstacle.

6.3.3 The correct way to overcome obstacles

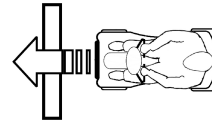

Right

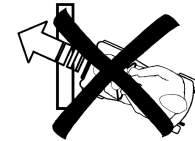

Wrong

Driving up over an obstacle

1. Approach the curb or obstacle slowly head-on. Shortly before the front wheels touch the obstacle, increase the speed and reduce only after the rear wheels have also climbed the obstacle.

Driving down off of an obstacle

1. Approach the curb or obstacle slowly head-on. Before the front wheels touch the obstacle, reduce speed and keep it until also the rear wheels have come down off of the obstacle.

6.4 Driving up and down gradients

For information concerning the maximum safe slope, refer to 12 Technical data, page 47.

**WARNING!****Risk of tipping over**

- Only ever drive downhill at a maximum of 2/3 of the top speed.
- If your scooter is fitted with an adjustable backrest, always return the backrest of your seat to an upright position before ascending slopes. We recommend that you lean the backrest slightly to the rear before descending slopes.
- Never attempt to ascend or descend a slope on slippery surfaces or where there is a danger of skidding (such as wet pavement, ice etc).
- Avoid trying to get out of the scooter on an incline or a gradient.
- Always drive in a straight direction along the road or path you are travelling on, rather than attempting to zigzag.
- Never attempt to turn around on an incline or a slope.

6.5 Parking and stationary

If you park your vehicle, or leave it idle or unattended for a longer period:

- I. Switch off the power supply (keyswitch) and remove key.

6.6 Use on public roads

The wheels may bear the note "Not For Highway Use". However, the mobility device may be used on all traffic routes for which it is approved in accordance with the relevant national legislation.

6.7 Pushing the scooter by hand**CAUTION!****Risk of injury if someone sits on a scooter with disengaged motors**

A scooter with disengaged motors can roll out of control.

- Disengage the motors only if no one is sitting on the scooter.

The motors of the scooter are fitted with automatic brakes, preventing the scooter from rolling away out of control when the power supply is switched off. When pushing the scooter, the magnetic brakes must be disengaged.

6.7.1 Disengaging motors**CAUTION!****Risk of the vehicle running away**

- When the motors are disengaged (for push operation whilst freewheeling), the electromagnetic motor brakes are deactivated. When the vehicle is parked, the levers for engaging and disengaging the motors must without fail be locked firmly into the "DRIVE" position (electromagnetic motor brakes activated).



The lever for engaging and disengaging the motor is located on the right-hand side at the rear.

Disengaging the drive

1. Switch off the scooter (keyswitch).
2. Press the unlocking knob on the disengaging lever (1).
3. Push the disengaging lever forwards.

The drive is now disengaged.

Engaging the drive

1. Pull the lever to the rear.
- The drive is now engaged.

6.8 Driving the scooter



WARNING!

Risk of injury from the unintended rolling of the vehicle

When stopping the vehicle, the drive lever needs to return entirely to the middle position to activate the electromagnetic brakes. If there is any obstruction stopping the lever from returning to the middle position, the electromagnetic brakes cannot be activated. This can lead to the vehicle rolling unintentionally.

- Ensure that the drive lever is in the middle position, if the vehicle is to remain stationary.

1. Switch the power supply on (keyswitch).
The operating console display illuminates. The scooter is ready to drive.



If the scooter is not ready to drive after switching on, check the status display (refer to 3.2.1 Status Display, page 14 and chapter 11.1 Diagnosis and fault repair, page 44).

2. Set the required speed with the speed controller.
3. Pull the right-hand drive lever carefully to travel forwards.
4. Pull the left-hand drive lever carefully to travel in reverse.



The control system is programmed with standard values in the works. Your Invacare dealer can carry out programming tailored to fit your requirements.



WARNING!

Any changes to the drive program can affect the driving characteristics and the tipping stability of the vehicle.

- Changes to the drive program may only be carried out by trained Invacare specialist dealers.
- Invacare supplies all mobility products with a standard drive program ex-works. Invacare can only give a warranty for safe vehicle driving behavior - especially the tipping stability - for this standard drive program.



To brake quickly, simply let go of the drive lever. It will then automatically return to the middle position. The scooter will brake.

7 Electrical system

7.1 Electronics protection system

The vehicle's electronics are fitted with an overload-protection system.

If the motors are put under considerable strain for a longer period of time (for example, when driving up a steep hill) and especially when the ambient temperature is high, then the electronic system could overheat. In this case the vehicle's power is reduced gradually until it finally comes to a halt. The status display shows a corresponding error code (refer to 11.1.2 Error codes and diagnostic codes, page 44). By switching the power supply off and back on again, the error code is cancelled and the electronics are switched back on. It will take approximately five minutes until the electronics have cooled down enough for the motors to restore full power again.

When the motors are stalled by an insurmountable obstacle, such as a high curb, and the vehicle driver allows the motors to strain against this hindrance for more than 20 seconds without moving, then the electronics will automatically switch off to prevent the motors from being damaged. The status display shows a corresponding error code (refer to 11.1.2 Error codes and diagnostic codes, page 44). By switching off and back on again, the error code is cancelled and the electronics are switched back on.

7.1.1 The main fuse

The entire electric system is protected against overload by two main fuses. The main fuses are mounted on the positive battery cables.



A defective main fuse may be replaced only after checking the entire electric system. An Invacare specialised dealer must perform the replacement. You can find information on the fuse type in chapter 12 Technical data, page 47.

7.2 Batteries

Power is supplied by two 12 V batteries. The batteries are maintenance-free and only need regular charging.

In the following, you find information on how to charge, handle, transport, store, maintain, and use batteries.

7.2.1 General information on charging

New batteries should always be fully charged once before their first use. New batteries will be at their full capacity after having run through approx. 10 - 20 charging cycles (break-in period). This break-in period is necessary to fully activate the battery for maximum performance and longevity. Thus, range and running time of your mobility device could initially increase with use.

Gel/AGM lead acid batteries do not have a memory effect as NiCd batteries.

7.2.2 General instructions on charging

Follow the instructions listed below to ensure safe use and longevity of the batteries:

- Charge 18 hours prior to initial usage.
- We recommend charging the batteries daily after every discharge even after partly discharge, as well as each night over night. Depending on the level of discharge, it can take up to 12 hours until the batteries are fully charged again.
- When the battery indicator reached the red LED range, charge the batteries for 16 hours minimum, neglecting the charge complete display!
- Try to provide a 24 hour charge once a week to make sure that both batteries are fully charged.
- Do not cycle your batteries at a low state of charge without regularly recharging them fully.

- Do not charge your batteries under extreme temperatures. High temperatures above 30 °C are not recommended for charging as well as low temperatures below 10 °C.
- Use only charging devices in Class 2. This class of chargers may be left unattended during charging. All charging devices which are supplied by Invacare comply with these requirements.
- You cannot overcharge the batteries when using the charger supplied with your mobility device, or a charger that has been approved by Invacare.
- Protect your charger from sources of heat such as heaters and direct sunlight. If the battery charger overheats, charging current will be reduced and the charging process delayed.

7.2.3 How to charge the batteries

1. Make sure you read and understand the battery charger's user manual, if supplied, as well as the safety notes on the front and rear panels of the charger.



WARNING!

Risk of explosion and destruction of batteries if the wrong battery charger is used

- Only ever use the battery charger supplied with your vehicle, or a charger that has been approved by Invacare.



WARNING!

Risk of electric shock and damage to the battery charger if it gets wet

- Protect the battery charger from water.
- Always charge in a dry environment.



WARNING!

Risk of short circuit and electric shock if the battery charger has been damaged

- Do not use the battery charger if it has been dropped or damaged.



WARNING!

Risk of electric shock and damage to the batteries

- NEVER attempt to recharge the batteries by attaching cables directly to the battery terminals.



WARNING!

Risk of fire and electric shock if a damaged extension cable is used

- Only ever use an extension cable if it is absolutely necessary. In case you must use one, make sure it is in good condition.



WARNING!

Risk of injury if using the wheelchair during charging

- DO NOT attempt to recharge the batteries and operate the wheelchair at the same time.
- DO NOT sit in the wheelchair while charging the batteries.

The charging socket is located on the left of the steering column.

1. Switch off the scooter.
2. Fold up the charging socket protective cap.
3. Connect the battery charger to the scooter.
4. Connect the battery charger to the power supply.

7.2.4 How to disconnect the batteries after charging

1. Disconnect the battery charger from the power supply.
2. Disconnect the battery charger from the scooter.
3. Close the charging socket protective cap.

7.2.5 Storage and Maintenance

Follow the instructions listed below to ensure safe use and longevity of the batteries:

- Always store the batteries fully charged.
- Do not leave the batteries in a low state of charge for an extended length of time. Charge a discharged battery as soon as possible.
- In case your mobility device is not used for a longer period of time (that is more than two weeks), the batteries must be charged at least once a month to maintain a full charge and always be charged before use.
- Avoid hot and cold extremes when storing. We recommend to store batteries at a temperature of 15 °C.
- Gel and AGM batteries are maintenance-free. Any performance issues should be handled by a properly trained mobility device technician.

7.2.6 Instructions on using the batteries



CAUTION!

Risk of damaging the batteries.

- Avoid ultra-deep discharges and never drain your batteries completely.

- Pay attention to the Battery Charge Indicator! Charge the batteries when the Battery Charge Indicator shows that battery charge is low.
How fast the batteries discharge depends on many circumstances, such as ambient temperature, condition of the surface of the road, tire pressure, weight of the driver, way of driving and utilisation of lighting.
- Try to charge the batteries always before you reach the red LED range.
The last 2 LED (one red and one orange) mean a remaining capacity of 20 — 30 %.
- Driving with blinking red LED means an extreme stress for the battery and should be avoided under normal circumstances.
- When only one red LED is blinking, the Battery Safe feature is enabled. From this time, speed and acceleration is reduced drastically. It will allow you to move the mobility device slowly out of a dangerous situation before the electronic finally cuts off. This is deep discharging and should be avoided.
- Be aware that for temperatures below 20 °C, the nominal battery capacity starts to decline. For example, at -10 °C the capacity is reduced to about 50 % of the nominal battery capacity.
- To avoid damaging the batteries, never allow them to be fully discharged. Do not drive on heavily discharged batteries if it is not absolutely necessary, as this will strain the batteries unduly and shorten their life expectancy.
- The earlier you recharge the batteries, the longer they live.

- The depth of discharge affects the cycle life. The harder a battery has to work, the shorter is its life expectancy.
Examples:
 - One deep discharge stresses the same as 6 normal cycles (green /orange display off).
 - The battery life is about 300 cycles at 80% discharge (first 3 LED off), or about 3000 cycles at 10% discharge.
- Under normal operation, once a month the battery should be discharged until all green and orange LED are off. This should be done within one day. A 16 hour charge afterwards is necessary as reconditioning.

7.2.7 Transporting batteries

The batteries supplied with your mobility device are not hazardous goods. This classification is based on the German GGVS Hazardous Goods Road Transport Ordinances, and the IATA/DGR Hazardous Goods Rail Transport / Air Transport Ordinances. Batteries may be transported without restrictions, whether by road, rail or by air. Individual transport companies have, however, guidelines which can possibly restrict or forbid certain transport procedures. Please ask the transport company regarding each individual case.

7.2.8 General instructions on handling the batteries

- Never mix and match different battery manufactures or technologies, or use batteries that do not have similar date codes.
- Never mix gel with AGM batteries.
- Always have your batteries installed by a properly trained mobility device technician. They have the necessary training and tools to do the job safely and correctly.

7.2.9 How to handle damaged batteries correctly



CAUTION!

Corrosion and burns from acid leakage if batteries are damaged

- Remove clothes that have been soiled by acid immediately.

After contact with skin:

- Immediately wash affected area with lots of water.

After contact with eyes:

- Immediately rinse eyes under running water for several minutes; consult a physician.





- Always wear safety goggles and appropriate safety clothing when handling damaged batteries.
- Place damaged batteries in an acid-resistant receptacle immediately after removing them.
- Only ever transport damaged batteries in an appropriate acid-resistant receptacle.
- Wash all objects that have come into contact with acid with lots of water.

Disposing of dead or damaged batteries correctly

Dead or damaged batteries can be given back to your dealer or directly to Invacare.

7.3 5 A battery charger

7.3.1 Symbols found on the product

	This product complies with Directive 93/42/EEC concerning medical devices. The launch date of this product is stated in the CE declaration of conformity.
	C-Tick (Australian EMC)
	This product complies with German and, if available, European safety requirements.
	
	Insulation class: Class II

7.3.2 Features

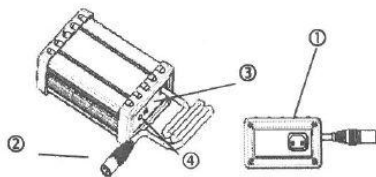

- 1 Mains socket
- 2 Battery charging plug
- 3 POWER LED display
- 4 CHARGING LED display

7.3.3 LED display

Green flashes	Waiting for connection to battery
Orange flashes	Pre-charge
Orange	Charging
Green and orange flashes	Charged 85 %
Green	Fully charged
Red flashes	Defect

7.3.4 Caution

- Before using the battery charger, read all instructions and cautionary markings.
- In order to extend the service life of the charger, you should not leave the electric vehicle connected to it for prolonged periods. Turn off the power after charging.
- Do not use the charger for totally discharged batteries or when the batteries are faulty.
- Use the charger in a well ventilated room.
- Only use the charger for gel or AGM batteries (16-60 Ah).
- Do not use for a voltage input other than that specified.
- The temperature of case will rise when charging. Avoid to touch the case directly.
- "Output Connector Not For Current Interrupting".
- For continued protection against risk of fire, replace only with same type and ratings of fuse.
- To reduce the risk of fire and electric shock, install in a temperature-and humidity-controlled indoor area relatively free of conductive contaminants.

- Power Supply Cord: Use UL Listed detachable power supply cord-No. 18 AWG, 2 conductors, flexible cord, rated 10 A, VW - I, 105 C, minimum 1.8 m , maximum 3 m long. Provided with a molded-on, non-polarized attachment plug with a 15 A, 125 V (NEMA1-15P) configuration and a molded-on connector which mates with the power inlet. The following cord types may be used:

Flexible cord type
S , SE,SO,SP-3 , SPT -3 , ST, STO, SJ , SJE, SJO , SJT, SJTO

7.3.5 Operating instructions

1. Make sure the battery charger output voltage is the same as the output voltage of the connecting battery.
2. Connect the power cord. The LED indicates red and green flash when AC power is on.
3. Connect the battery charger to the battery.
4. Start charging. Refer to 7.3.3 LED display, page 32.

7.3.6 Troubleshooting

- If the POWER LED (red) is off:
 - Check that the charging cable is correctly connected.
 - If the LED still does not light, the battery charger may be faulty. Contact your dealer.
- If the CHARGING LED is off:
 - Check that the charging cable is correctly connected.
 - If the battery is fully charged, the charger will switch to trickle charge mode and the CHARGING LED light goes out.
 - If the charging process was not started (orange LED), the battery could be faulty. Contact your dealer.

- If the green CHARGING LED keeps flashing, it cannot turn to indicate charging:
 - Check if the battery is connected successfully.
 - Check if the output connection is short or open.
 - If the battery connection is ok, the battery charger may be faulty.
- If the POWER LED (red) keeps flashing:
 - Check if the battery connection is reversed.
 - Check if the output connection is short or open.
 - Check if the environment temperature is too low ($< 0\text{ }^{\circ}\text{C}$)
 - If the POWER LED keeps flashing, the battery charger may be faulty.
- If the CHARGING LED does not change from orange to green:
 - The battery cannot be charged correctly. It may be faulty. Stop charging and contact your dealer.
- If the CHARGING LED changes from orange to green immediately:
 - The battery is either fully charged or faulty. Contact your dealer.

7.3.7 Technical specifications

Item	Battery charger (switch mode)
Model	4C24050A
Output current (DC)	5 A \pm 5 %
Charging voltage (DC)	28.8 V
Floating voltage (DC)	27.6 V

Input current (AC)	2.5 A max.
Input voltage (AC)	100 - 240 V, 50/60 Hz
Degree of efficiency	AC-DC 80%
Operating temperature	0 °C – 40 °C
Switching method	Switch mode
Charging method	Constant current, two levels of constant voltage method
Battery application	24 V gel or AGM batteries (16 Ah – 60 Ah)
Output detection	<ol style="list-style-type: none"> 1. Short-circuit protection 2. Reverse power protection 3. Overheat protection 4. Charging plug protection 5. Automatic cut off when reaching 12 hours constantly charging
Operating Humidity	20 % – 85 %
Dimensions L x W x H	190 mm x 100 mm x 55 mm
Weight	965 g
Color	Black

8 Transport

8.1 Transport - General information



WARNING!

Risk of severe or fatal injuries in the event of a traffic accident if this mobility device is used as a vehicle seat! It does not fulfill the requirements of ISO 7176-19:2001.

- Under no circumstances should this mobility device be used as a vehicle seat or to transport the user in a vehicle.

8.2 Transporting the Scooter



WARNING!

Risk of injury or damage

- After any adjustments, repair or service and before use, make sure that all attaching hardware is tightened securely - otherwise injury or damage may result.
- Before performing any maintenance, adjustment or service, turn power off and remove key from ignition.
- Do not lift the scooter by the rear shroud - otherwise damage to the scooter may occur.

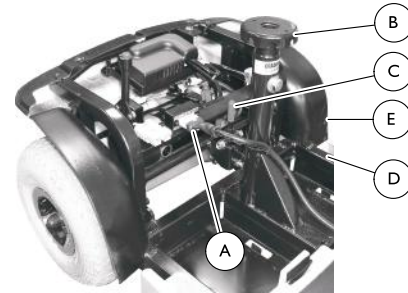

Disassembling the Scooter

1. Turn power off and remove the key from the ignition.
2. Remove the basket.
3. Remove the seat. Refer to 5.5 Removing/Installing the seat, page 20.
4. Remove the batteries. Refer to 8.3 Removing/Installing the Batteries, page 36.
5. Disconnect the main wiring harness connector (A).
6. Hold the seat post (B) with one hand.
7. With the other hand, push the release lever (C) to the rear of the scooter.
8. Lift the seat post to separate the front frame assembly (D) from the rear frame assembly (E).
9. Fold tiller down to lowest locked position. Refer to 5.7 Adjusting the Tiller Angle, page 21.

Assembling the Scooter

1. Unfold tiller. Refer to 5.7 Adjusting the Tiller Angle, page 21.
2. Hold the seat post (B) and align the curved brackets on the front frame assembly (D) with the posts on the rear frame assembly (E).
3. While holding the seat post, slowly pivot the front frame assembly down until the release lever (C) locks.

4. Ensure the release lever is locked and the front and rear frame assemblies are connected.
5. Connect the main wiring harness connector (A).
6. Install the batteries. Refer to 8.3 Removing/Installing the Batteries, page 36.
7. Install the seat. Refer to 5.5 Removing/Installing the seat, page 20.
8. Install the basket.

8.3 Removing/Installing the Batteries

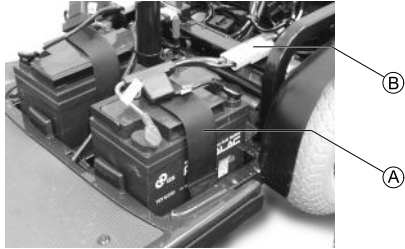

3. Secure the batteries to the base frame using the battery retention strap (A). Securely tighten.

 The battery retention strap should go under the battery harnesses.

4. Install the rear cover.
5. Reinstall the seat. Refer to 5.5 Removing/Installing the seat, page 20.

Removing the Batteries

1. Turn power off and remove the key from the ignition.
2. Remove the seat. Refer to 5.5 Removing/Installing the seat, page 20.
3. Pull up to remove the rear cover.
4. Open the battery retention strap (A).
5. Disconnect the battery harness connectors (B).
6. Remove the batteries from the base frame.

Installing the Batteries

1. Install the two batteries onto the base frame.

 Orient the batteries as shown in the illustration.

2. Connect the battery harness connectors (B).

9 Maintenance

9.1 Maintenance introduction

The term “Maintenance“ means any task performed to ensure that a medical device is in good working order and ready for use as intended. Maintenance encompasses different areas, such as everyday care and cleaning, inspection checks, repair tasks and refurbishment.



Have your vehicle checked once a year by an authorised Invacare dealer in order to maintain its driving safety and roadworthiness.

9.2 Cleaning the mobility device

When cleaning the mobility device, pay attention to the following points:

- Only use a damp cloth and gentle detergent.
- Do not use any abrasive or scouring agents.
- Do not subject the electronic components to any direct contact with water.
- Do not use any high-pressure cleaning devices.

Disinfection

Spray or wipe disinfection using a tested and recognised product is permitted. A list of the current permitted disinfectants is available from the Robert Koch Institute at <http://www.rki.de>.

9.3 Inspection checks

The following table lists inspection checks that should be performed by the user and their intervals. If the mobility device fails to pass one of the inspection checks, refer to the chapter indicated or contact your authorized Invacare dealer. A more comprehensive list of inspection checks and instructions for maintenance work can be found in the service manual for this device, which can be obtained from Invacare. That manual, however, is intended to be used by trained and authorized service technicians, and describes tasks which are not intended to be performed by the user.

Inspection work (to be carried out by user)	Before each journey	Weekly	Monthly
Seat and backrest padding:			
Check for perfect condition.			✓
Horn:			
Check function. Contact your dealer in case of failure.	✓		
Tires:			
Have tires checked for specified air pressure.	✓	✓	

Inspection work (to be carried out by user)	Before each journey	Weekly	Monthly
Check for foreign bodies (glass splinters, nails) and damage. Replace tire if necessary.		✓	
Front wheels:			
Front wheels must spin smoothly.		✓	
If wheels wobble or do not spin easily, adjust steering pivot pin or front wheel bearing.			✓
Rear wheels:			
Test wheel for firm seat on the axle drive shaft.			✓
Rear wheels must spin without wobbling.			✓
Electronics / electrical system:			
Check all plug connections for condition and firm connection.			✓
Have batteries been fully charged before the daily operation?	✓		
Are all holders, screws firmly fixed, tight and safe?			✓
Are all electric bulbs of the lighting system (if applicable) in working order?	✓		
Cleaning:			
Clean all parts carefully.	When necessary		

9.4 Repair Instructions



Important information about maintenance work tools!

– Some maintenance work which is described in this manual and can be carried out by the user without problems require the correct tools for proper work. If you do not have the correct tool available we do not recommend that you try to carry out the relevant work. In this case, we urgently recommend that you contact an authorised specialist workshop.

The following are instructions on maintenance and repairs that can be performed by the user. For the specifications of spare parts please see 12 Technical data, page 47, or consult the service manual, available from Invacare (in this connection please see the addresses and phone numbers at the end of this user manual). In case you require assistance, please contact your Invacare dealer.



CAUTION!

Risk of damage or injury if the vehicle is accidentally set into motion during repairs

- Switch the power off (ON/OFF Button).
- Engage the motors.
- Secure the vehicle against rolling away by placing wedges under the wheels.



CAUTION!

Risk of hands and feet being crushed by the weight of the wheelchair

- Pay attention to your hands and feet.
- Use the correct lifting techniques.

9.4.1 Removing/Installing the Drive Wheels



This procedure applies to the rear wheels of the four wheel and three wheel models.

Take note of position and orientation of wheel and mounting hardware before removing.



Tools:

- 17 mm spanner
- Rubber mallet
- Screwdriver
- 17 mm safety nut

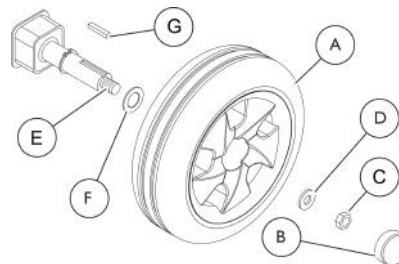

Removing the Drive Wheels

1. Turn power off and remove the key from the ignition.
2. Remove the seat. Refer to 5.5 Removing/Installing the seat, page 20.
3. Place the rear frame assembly (not shown) up on blocks so that the drive wheels (A) are off the ground.
4. Remove the cap (B), locknut (C) and small washer (D) from the threaded end of the drive shaft (E).

- Remove the existing drive wheel assembly from the drive shaft.

 Use a wheel puller if necessary to remove the wheel from the drive shaft.

- Remove the large washer (F) from the drive shaft.
- Remove keystone (G) from drive shaft. Set aside.
- If necessary, repeat STEPS 3 - 6 to remove other drive wheel.

Installing the Drive Wheels

- Place keystone (G) in cutout on drive shaft (E) as shown in the illustration above.

 The keystone in the drive shaft MUST lineup with the cutout in the wheel hub.

If necessary, use a rubber hammer to gently tap drive wheel completely into position on the drive shaft.

- Install the large washer (F) onto the drive shaft.
- Install the drive wheel (A) onto the drive shaft.
- Secure wheel to drive shaft by installing the small washer (D) and locknut (C) onto the threaded end of the drive shaft. Securely tighten.
- Install the cap (B).
- Repeat STEPS 1-5 to install the other drive wheel.
- Install the seat. Refer to 5.5 Removing/Installing the seat, page 20.

9.4.2 Removing/Installing the Front Wheel - Three Wheel Models

 Take note of position and orientation of wheel and mounting hardware before removing.

Reverse this procedure to install the front wheel.



Tools:

- 12 mm spanner
- 13 mm spanner
- 13 mm safety nut

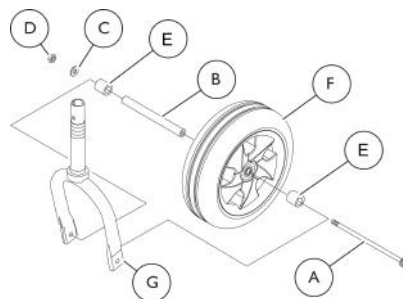

- Turn power off and remove the key from the ignition.
- Place the front of the scooter up on blocks so that the front wheel is off the ground.
- Remove the bolt (A), axle (B), washer (C), nut (D) and two spacers (E) that secure the wheel (F) to the fork (G).
- Remove the wheel from the fork.

9.4.3 Removing/Installing the Front Wheels - Four Wheel Models



Take note of position and orientation of wheel and mounting hardware before removing.



Tools:

- 17 mm spanner
- Rubber mallet
- Screwdriver
- 17 mm safety nut

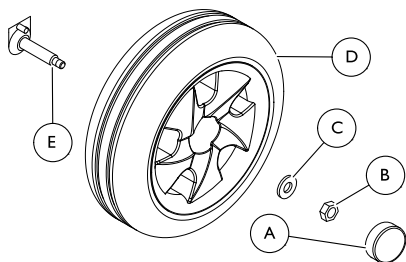

Removing the Front Wheels

1. Turn power off and remove the key from the ignition.
2. Place the front of the scooter up on blocks so that the front wheels are off the ground.
3. Remove the cap (A), locknut (B) and washer (C) that secure the front wheel (D) to the front axle (E).
4. Remove the front wheel from the front axle.
5. If necessary, repeat STEPS 3 – 4 to remove the remaining front wheel.

Installing the Front Wheels

1. Align the front wheel (D) with the front axle (E).
2. Use the washer (C) and locknut (B) to secure the front wheel to the front axle.
3. Securely tighten the front wheel mounting hardware.
4. Install the cap (A).
5. If necessary, repeat STEPS 1 — 4 to install the remaining front wheel.

9.4.4 Repairing tire punctures (pneumatic tires of type 10")



Tools:

- Inner tube repair set **or** a new inner tube
- Talcum powder
- 13 mm socket spanner
- 13 mm open-ended spanner



1. Remove valve cap.
2. De-inflate the tire by pressing in the center valve pin.
3. Loosen the four bolts (I) with the socket spanner and remove them.
4. Remove both wheel rim halves out of the tire and remove the inner tube.
5. Repair the inner tube and refit in the wheel, or replace it with a new inner tube.



If the old inner tube has been repaired and is to be used again, and became wet during repair, it is easier to replace it if it is lightly dusted with talcum powder beforehand.

6. Refit the wheel rim parts from outside into the tire.
7. Pump up the tire lightly.
8. Reinsert the nuts and bolts which hold the wheel rim together and tighten fully.
9. Make sure that the tire is properly located on the wheel rim.
10. Inflate the tire up to the recommended tire pressure.
11. Check to make sure that the tire is still located properly on the wheel rim.
12. Screw the valve cap back on.
13. Locate the wheel on the drive shaft again.
14. Reassemble the wheel.

10 After Use

10.1 Disposal

- The equipment wrapping is potentially recyclable.
- The metal parts are used for scrap metal recycling.
- The plastic parts are used for plastic recycling.
- Electric components and printed circuit boards are disposed of as electronic scrap.
- Exhausted or damaged batteries can be returned to your medical equipment supplier or Invacare.
- Disposal must be carried out in accordance with the respective national legal provisions.
- Ask your city or district council for details of the local waste management companies.

II Troubleshooting

II.1 Diagnosis and fault repair

The electronic system offers diagnostic information to support the technician during the recognition and rectification of faults on the scooter. If there is a fault, the status display flashes several times, pauses, then flashes again. The type of fault is displayed by the number of flashes in each group, which are also known as the "flash code".

The electronic system reacts differently depending on the seriousness of the fault and its effect on user safety. It can, for example:

- Show the flash code as a warning and allow both driving and normal operation to continue.
- Display the flash code, stop the scooter and prevent further travel until the electronic system has been switched off and switched on again.
- Display the flash code, stop the scooter and not permit further travel until the fault has been rectified.

II.1.2 Error codes and diagnostic codes

Flash code	Fault	Consequence for the scooter	Comments
1	Battery must be charged	Continues to drive	<ul style="list-style-type: none"> • The batteries are discharged. Charge the battery as soon as possible.
2	Battery voltage too low	Stops driving	<ul style="list-style-type: none"> • The batteries are depleted. Charge batteries. • If you switch the scooter off for a few minutes, the battery can often recuperate to such a stage that a short journey is still possible. You should only do this in an emergency, however, because this causes the batteries to become excessively discharged.

You can find detailed descriptions of individual flash codes, including possible causes and fault repair, in the section entitled II.1.2 Error codes and diagnostic codes, page 44.

II.1.1 Error diagnosis

If the scooter shows a failure, please use the following guide to locate the fault.



Before making any diagnosis, ensure that the scooter has been switched on at the keyswitch.

If the status display is OFF:

- Check whether the keyswitch is SWITCHED ON.
- Check whether all cables are correctly connected.

If the status bar indicator is FLASHING:

- Count the number of flashes and then proceed to the next section.

Flash code	Fault	Consequence for the scooter	Comments
3	Battery voltage too high	Stops driving	<ul style="list-style-type: none"> • The battery voltage is too high. If the battery charger is connected, disconnect it from the scooter. • The electronic system charges the batteries when running downhill and when braking. This fault is caused when the battery voltage becomes too high during this process. Switch the scooter off and on again.
4	Power time exceeded	Stops driving	<ul style="list-style-type: none"> • The maximum current was exceeded over too long a period, probably because the motor was overloaded or has been working against an immovable resistance. Switch the scooter off, wait a few minutes and then switch on again. • The electronic system has determined a motor short-circuit. Check the wiring harness for short-circuit and check the motor. • Contact your Invacare dealer.
5	Brake failure	Stops driving	<ul style="list-style-type: none"> • Ensure that the disengaging lever is in the engaged position. • There is a defect in the braking coil or in the cabling. Check the magnetic brake and cabling for open or short-circuited circuitry. Contact your Invacare dealer.
6	No neutral position when switching Scooter on.	Stops driving	<ul style="list-style-type: none"> • Drive lever is not in neutral when the keyswitch was turned. Put the drive lever in neutral, turn the power off and then turn on again. • It may be necessary to replace the drive lever. Contact your Invacare dealer.
7	Fault in speed potentiometer	Stops driving	<ul style="list-style-type: none"> • The drive lever electronics could be faulty or incorrectly connected. Check the cabling for open or short-circuited circuitry. • Potentiometer is not correctly adjusted. Put the potentiometer into the center position.



Flash code	Fault	Consequence for the scooter	Comments
8	Motor voltage error	Stops driving	<ul style="list-style-type: none">• The motor or its cabling is defective. Check the cabling for open or short-circuited circuitry.
9	Miscellaneous internal fault	Stops driving	<ul style="list-style-type: none">• Contact your Invacare dealer.
10	Push/freewheel mode error	Stops moving	<ul style="list-style-type: none">• The scooter has exceeded the permissible maximum speed during pushing or freewheeling. Switch the electronics system off and on again.

I2 Technical data

12.1 Technical specifications

The technical information provided hereafter applies to a standard configuration or represents maximum achievable values. These can change if accessories are added. The precise changes to these values are detailed in the sections for the respective accessories.

Permissible operating and storage conditions	
Temperature range for operation according to ISO 7176-9:	• -25° ... +50 °C
Temperature range for storage according to ISO 7176-9:	• -40° ... +65 °C

Electrical system	
Motors	• 1 x 240 W
Batteries	• 2 x 12 V/36 Ah (C20) leakproof/AGM • 2 x 12 V/40 Ah (C20) leakproof/AGM • 2 x 12 V/40 Ah (C20) leakproof/gel
Main fuse	• 70 A
Degree of protection	IPX4 ¹
Insulation class	Class II 
Applied part type	Type B Applied Part ² 

Charging device	
Output current	• 5 A ±
Output voltage	• 24 V nominal (12 cells)

Charging device	
Input voltage	<ul style="list-style-type: none"> • 200 – 250 V nominal
Operating temperature (surroundings)	<ul style="list-style-type: none"> • -25° ... +50 °C
Storage temperature	<ul style="list-style-type: none"> • -40° ... +65 °C

Tires	
Tire type	<ul style="list-style-type: none"> • 10" pneumatic or puncture-proof
Tire pressure	<p>The recommended maximum tire pressure in bar or kpa is marked on the side wall of the tire or the rim. If more than one value is listed, the lower one in the corresponding units applies.</p> <p>(Tolerance = -0.3 bar, 1 bar = 100 kpa)</p>

Driving characteristics	
Speed (dependent on country - please ask your dealer which speed is available in your country.)	<ul style="list-style-type: none"> • 6 km/h • 8 km/h
Min. braking distance	<ul style="list-style-type: none"> • 1000 mm (6 km/h) • 1500 mm (8 km/h)
Max. safe slope ³	<ul style="list-style-type: none"> • 10° (17.5 %)
Max. climbable obstacle height	<ul style="list-style-type: none"> • 60 mm
Turning diameter	<ul style="list-style-type: none"> • 2620 mm (4-wheel version) • 2320 mm (3-wheel version)
Turning width	<ul style="list-style-type: none"> • 1520 mm
Drive range in accordance with ISO 7176-4:2008 ⁴	<ul style="list-style-type: none"> • 38 km (8 km/h) • 34 km (6 km/h)

Dimensions according to ISO 7176-15	
Overall length	• 1220 mm
Drive unit width	• 590 mm
Overall width (armrest adjustment range)	• 580 – 730 mm
Total height	• 990 mm
Seat width	• 470 mm
Seat depth	• 410 mm
Seat angle	• 6°
Backrest height ⁵	• 475 mm
Backrest angle	• 99.5°
Armrest height	• 200 mm

Weight	
Curb weight	• 83.5 kg

Component weights	
Chassis	<ul style="list-style-type: none"> • 3-wheel: approx. 40.5 kg • 4-wheel: approx. 46 kg
Seat unit	• approx. 14 kg
Batteries	• approx. 12 kg per battery

Payload	
Max. payload	• 136 kg

Axle loads	
Max. front axle load	• 85 kg
Max. rear axle load	• 160 kg

- 1 IPX4 classification means that the electrical system is protected against spray water.
- 2 Applied Part complying with the specified requirements for protection against electrical shock according to IEC60601-1. (An applied parts is a part of the medical equipment which is designed to come into physical contact with the user or parts that are likely to be brought into contact with the user.)
- 3 Static stability according to ISO 7176-1 = 9° (15.8 %)
Dynamic stability according to ISO 7176-2 = 6° (10.5 %)
- 4 Note: The drive range of a mobility device is strongly influenced by external factors, such as the charging state of the batteries, surrounding temperature, local topography, road surface characteristics, tire pressure, weight of user, drive style and use of batteries for lighting, servos etc.

The specified values are theoretical maximum achievable values measured according to ISO 7176-4:2008.
- 5 Measured without seat cushion

Notes

Australia:

Invacare Australia PTY. Ltd.
1 Lenton Place, North Rocks N.S.W.
2151, Sydney, Australia
Tel. 61-2-8839-5333
Fax. 61-2-8839-5353
sales@invacare.com.au
www.invacare.com.au

United Kingdom:

Invacare Limited
Pencoed Technology Park, Pencoed
Bridgend CF35 5AQ
Tel: (44) (0) 1656 776 222
Fax: (44) (0) 1656 776 220
uk@invacare.com
www.invacare.co.uk

Canada:

Invacare Corporation
570 Matheson Blvd E Unit 8
Mississauga Ontario
L4Z 4G4 Canada
800-668-5324

Eastern Europe & Middle East:

Invacare GmbH, EDO
Kleiststraße 49
D-32457 Porta Westfalica
Tel: (49) (0)57 31 754 540
Fax: (49) (0)57 31 754 541
edo@invacare.com
www.invacare.eu.com

Ireland:

Invacare Ireland Ltd,
Unit 5 Seatown Business Campus
Seatown Road, Swords, County Dublin
Tel : (353) | 810 7084
Fax: (353) | 810 7085
ireland@invacare.com
www.invacare.ie

New Zealand:

Invacare New Zealand Ltd
4 Westfield Place, Mt Wellington,
Auckland
Tel: 64-9-917 3939
Fax: 64-9-917 3957
sales@invacare.co.nz
www.invacare.co.nz

EC	REP
----	-----

European representative:

EMERGO EUROPE
Molenstraat 15
2513 BH, The Hague
The Netherlands

**Manufacturer:**

CHIEN TI ENTERPRISE CO. LTD.
No. 13, Lane 227, Fu Ying Road
Hsin Chuang, Taipei, Taiwan
R.O.C.

1506942-P 2014-10-30



Making Life's Experiences Possible™



Yes, you can.®