

MicroP25RX

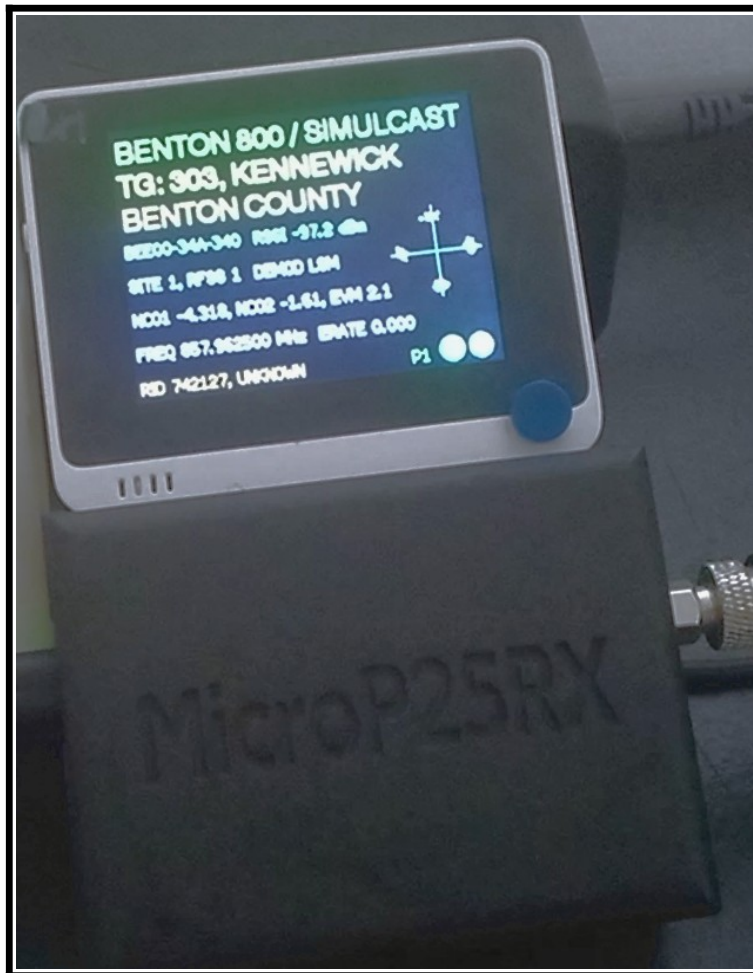

User Manual

Table of Contents

1.0 INTRODUCTION.....	4
2.0 IN THE PACKAGE.....	5
3.0 ATTACHING THE WIO TERMINAL DISPLAY.....	6
4.0 BUTTON MODE SELECTION.....	7
4.1 JOYSTICK BUTTON.....	7
4.2 MONITOR MODE BUTTON-MAPPING.....	8
4.3 TG ZONE MODE BUTTON-MAPPING.....	8
4.4 CONFIG MODE BUTTON-MAPPING.....	9
4.4.1 Configuration Menu.....	10
4.4.2 ZIP CODE SEARCH.....	10
4.4.3 ADD P25 SYSTEM.....	11
4.4.4 EDIT.....	11
4.4.5 SD CARD.....	13
4.4.6 FLASH CONFIG.....	16
4.4.7 AUDIO.....	18
4.4.8 ROAMING CONFIG.....	19
4.4.9 ROAM TIMEOUT.....	21
5.0 FIRMWARE UPDATES.....	22
5.1 UPDATING THE RECEIVER FIRMWARE.....	22
5.2 UPDATING THE DISPLAY FIRMWARE.....	23
6.0 HW CONNECTORS.....	24
6.1 AUDIO JACK.....	24
6.2 ANTENNA CONNECTOR.....	24
7.0 USB CONNECTORS.....	24
8.0 RECEIVER SPECIFICATIONS.....	25
9.0 DOCUMENT HISTORY.....	26
10.0 SOURCE CODE.....	26
11.0 FCC DATABASE AND US ZIP CODE FILES.....	26
12.0 TROUBLESHOOTING.....	26
13.0 APPENDIX – BACKUP FILE FORMAT.....	27
13.1 NOTE TO ADVANCED USERS.....	27
13.2 [GLOBAL CONFIG] SECTION.....	27
13.3 [SYSTEM] SECTION.....	29
13.4 [ALIASES] SECTION -PER SYSTEM.....	29
13.5 [IDEN] SECTIONS -PER SYSTEM.....	29
13.6 [SITE] SECTIONS -PER SYSTEM.....	30
13.7 [TALKGROUPS] SECTION -PER SYSTEM.....	31
14.0 ENCLOSURE ASSEMBLY.....	32

1.0 Introduction

The MicroP25RX is a P25 Phase 1 / Phase 2 (TDMA) trunk-tracking receiver that is designed to work in challenging environments. BlueTail Technologies is the only American company producing non-subscriber receivers that are immune to issues related to simulcast distortion. Our advanced digital signal processing combined with IQ / quadrature demodulation delivers superior performance. Our receivers are the first and only non-subscriber units that are capable of monitoring the new "TDMA CC" systems starting to be deployed in multiple areas of the country. The initial release of the MicroP25RX receiver is designed to work with the SeeedStudio Wio Terminal Display. The BlueTail Technologies source code for the display is available under a permissive MIT license. Users are encouraged to fork the source from github and make modifications. The enclosure is available as an option. The MicroP25RX has advanced features such as location-based-scanning via zip code entry. Enter a US zip code, a search radius in miles to search an FCC database on the SD card for all the P25 systems in your area. For systems not contained in the FCC database (state-based systems, federal systems), there is a separate file that can be edited for use with the zip code search. As the receiver learns new network information from the control channel, the information is written to a robust, flash-based file system. The file system utilizes a journaling technique to prevent file system corruption during power supply glitches. Other advanced features are talk-group zones, RID-alias display per system, talk groups per system and multiple scanning / roaming modes that allow monitoring a single system with rotating control channels or multiple systems with different configurations from VHF to UHF bands. Talk group backup files from the P25RX/P25RX-II can be imported from the SD card. RID-alias files, DSD-formatted talk groups files, and site files can be imported from the SD card. The BACKUP function creates an ini-style text file and contains 100% of the device configuration (including network, talk groups, alias, calibration, etc) The backup file is human readable and can be edited in a text editor if desired. The restore function can be used to clone a device. Other than transferring files to the SD card, a PC is not required for configuration.

2.0 In The Package

Included

- MicroP25RX PCB + Wio Adapter PCB – tested and ready to use
- rubber pads for shimming the Wio Terminal Display
- base / stand parts. These may be used to form a base for the MicroP25RX when it is not installed in the plastic enclosure. A light adhesive is recommended to attach these parts. e.g. RTV.

Included At No Cost While Supplies Last

- Ear buds – with adjustable volume control
- 770/850 MHz antenna + 100mm coax cable. SMA Male connector

Optional Add-On:

- Plastic MicroP25RX enclosure (Natural white. Can be spray painted).

NOT INCLUDED

- **Wio Terminal Display** (you will need to purchase this from digikey, mouser). The typical price is \$35-\$40. **MANF PART# 102991299**
DESCRIPTION: ATSAMD51 Wio
- uSD CARD
- USB cable – Micro-B for the receiver (MUST BE A DATA CABLE)
- USB cable – Type C for updating the Wio Terminal display firmware
- 3.5mm audio cable

3.0 Attaching The Wio Terminal Display

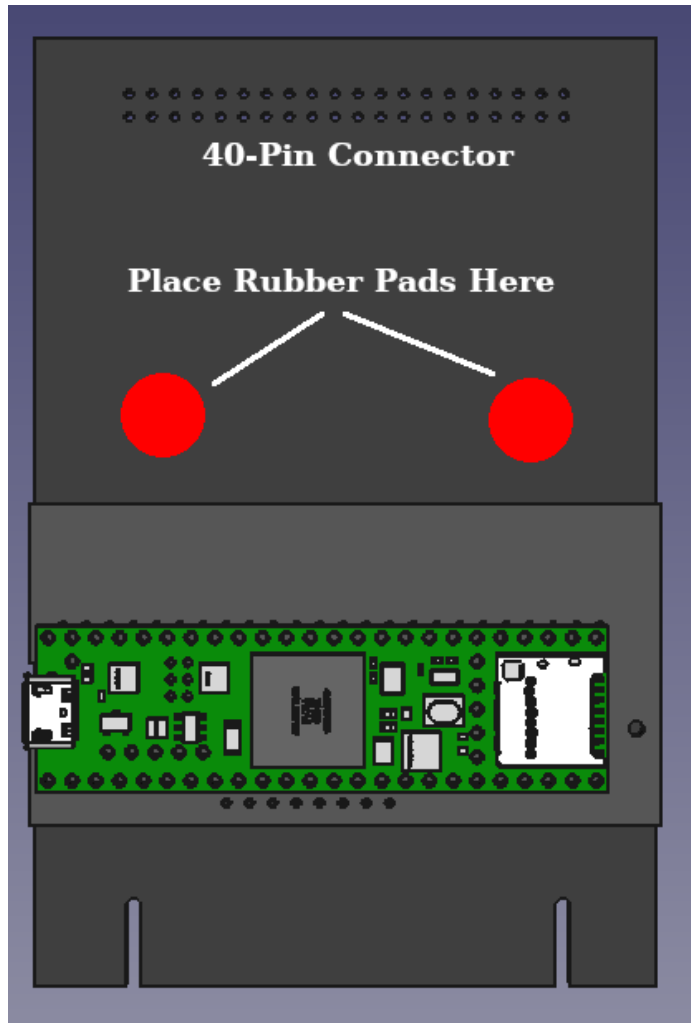

The Wio Terminal must be removed from the 40-pin connector in order to install the enclosure cover. The cover is installed while the receiver pcb is slid up to the edge of the plastic enclosure. The Wio Terminal Display goes on last when assembling and comes off first when disassembling. The rubber pads are placed approximately where shown on the pcb or can be installed on the backside of the Wio Display. The pads provide shimming for the display when it is connected to the 40-pin connector. The 40-pin connector provides 5V power to the Wio Terminal Display and a 4-wire SPI port for full-duplex communications to the receiver.

4.0 Button Mode Selection

Please read this section carefully. Button mode selection determines the mapped functions of the buttons. Button Mode Selection can be entered by pressing in on the joystick button. Available modes are MONITOR, CONFIG, and TG ZONE. Selecting each of these three modes changes what the buttons do. This may not be immediately intuitive, but is necessary to expand the functionality of a limited number of buttons. Note, when ROAMING MODE=5 and the mode is CONFIG MODE, the top buttons are mapped differently for fine-grained selection of which sites to scan.

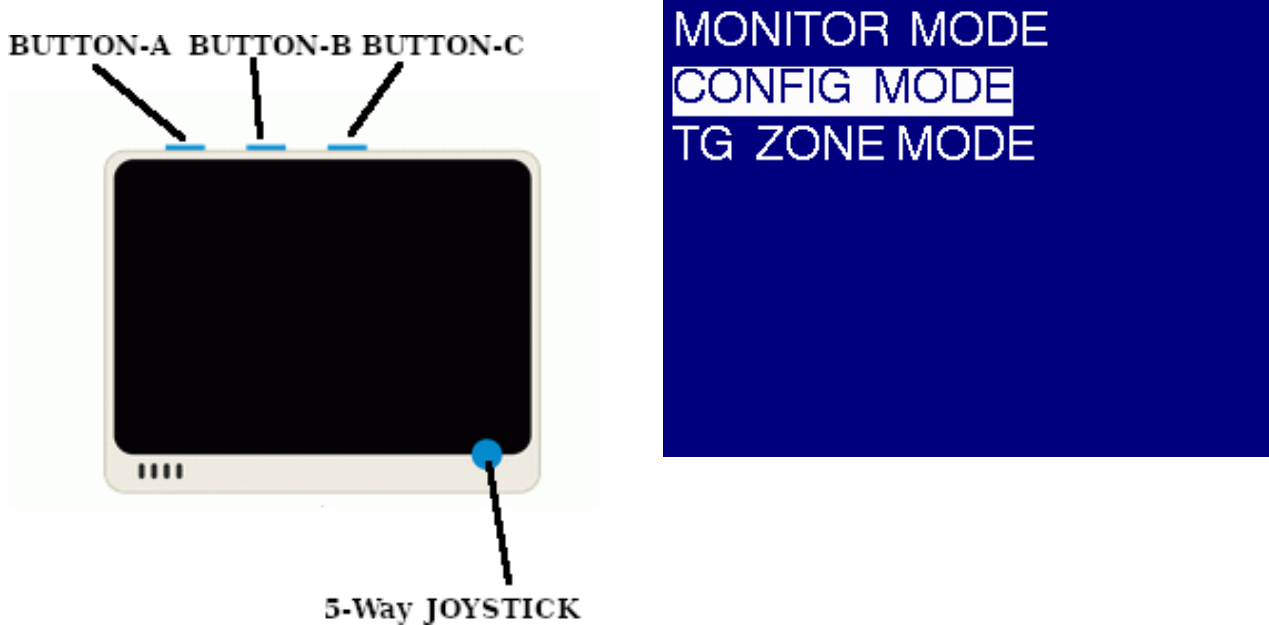

4.1 JOYSTICK BUTTON

The joystick button is a 5-way switch, left/right, up/down, pressed-in. When the keyboard entries are displayed, the joystick is used to determine which alpha/numeric values are to be selected. Pressing the button is the select function. Keyboard entry options are either aborted with the top-middle button or completed by selecting the ENTER key followed by pressing the joystick button inward. In the MONITOR and CONFIG modes, the joystick left/right, up/down movements are used to select frequencies. For menu selections, the up/down highlights different menu options while joystick-press selects the highlighted option.

4.2 MONITOR MODE BUTTON-MAPPING

In monitor mode, the button mappings are:

Button-A = TG Follow/UnFollow (will display an 'H' indicator when holding)

Button-B = AUDIO Mute / UnMute (will display an 'M' indicator when muted)

Button-C = Skip TG for 60 seconds

Note: The receiver only scans in monitor mode. Displays: "ROAM-ON-X"

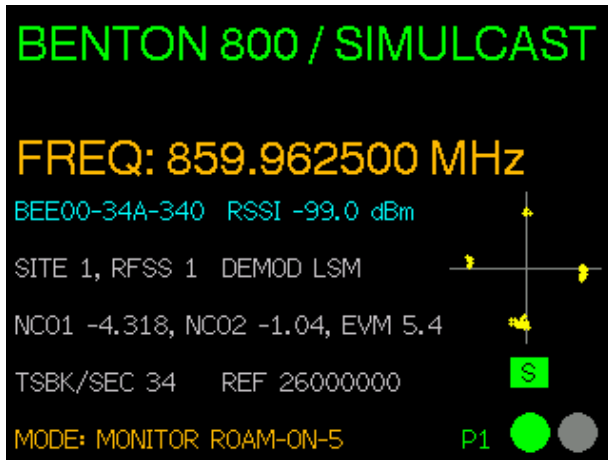

Figure 2: Monitor Control Channel

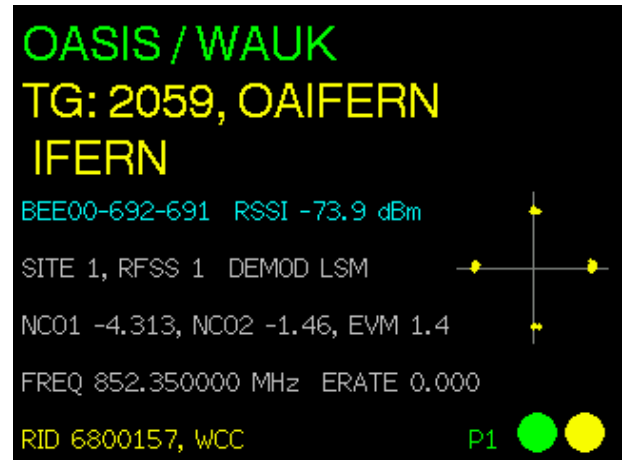

Figure 1: Monitor Voice Channel

4.3 TG ZONE MODE BUTTON-MAPPING

In TG Zone mode, the button mappings are:

Button-A = Enable / Disable Zone

Button-B = Rename Zone

Button-C = Return To Monitor Mode

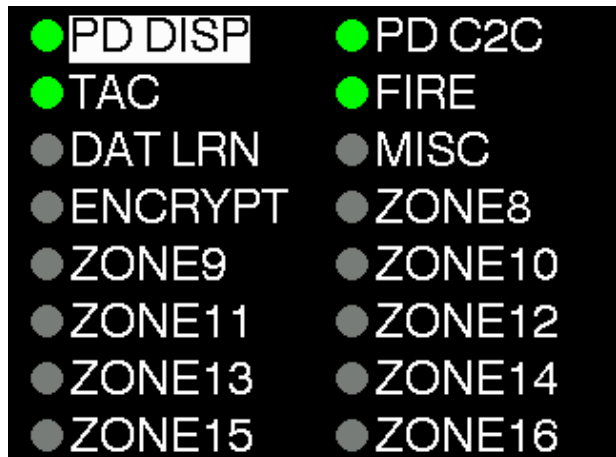

4.4 CONFIG MODE BUTTON-MAPPING

In Configuration mode, the button mappings are:

Button-A = Enable / Disable LEARN MODE

Button-B = Display Configuration Menu

Button-C = Site Demodulation Selection LSM / FM

Except when in ROAMING MODE=5, then

Button-A = Include In Scan (will display 'S')

Button-B = Display Configuration Menu

Button-C = Exclude From Scan

Joystick left-right cycles site frequencies, up-down cycles secondary sites.

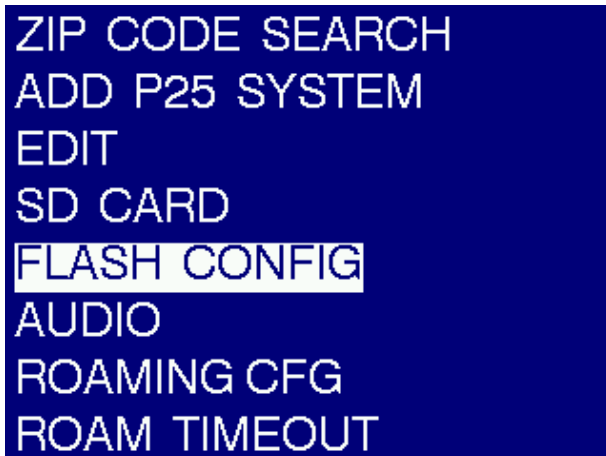
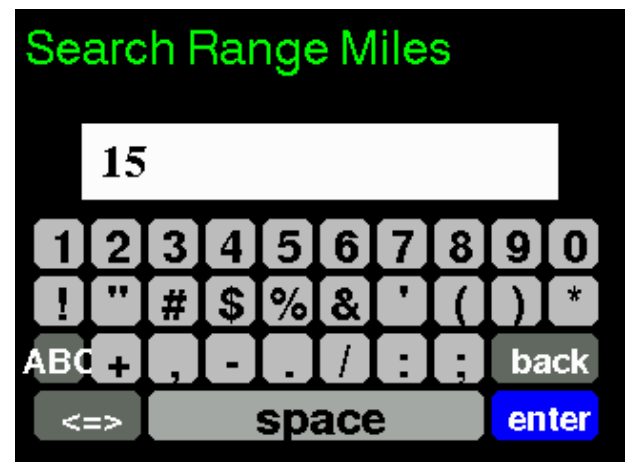
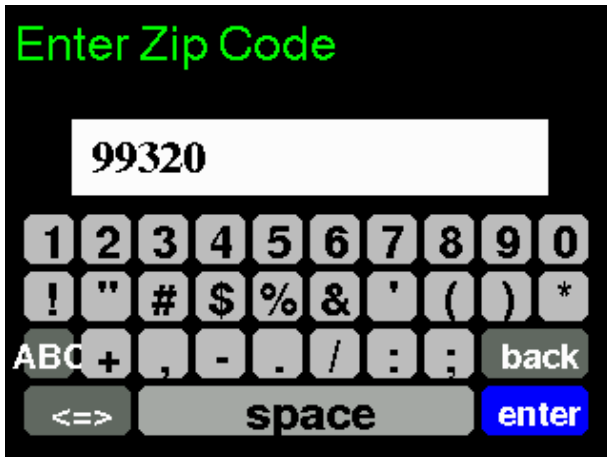

Figure 3: Configuration Menu

4.4.1 Configuration Menu

4.4.2 ZIP CODE SEARCH



Zip code Search will scan frequencies around your area and add active control channels to the receiver configuration. The 5-digit zip code is used to look up latitude / longitude coordinates from a file contained on an SD card (on the receiver). The next prompt is for the search radius around the lat/long that you would like to search. The search radius is a filter that limits search results from the records in the FCC database files to be within the specified distance in miles. The site records are contained in two files on the SD card, freqs.csv (FCC records), and an optional file named freqs_user.csv. The freq_user file allows adding custom records to the zip search. The us_zipcodes.csv and freqs.csv files can be downloaded from BlueTail Technologies web site. When performing a search the LEARN MODE is enabled on the receiver. When learn mode is enabled, configuration updates from the control channel are written to flash memory. After the zip search is completed a message will appear on the display to indicate this, then the device will switch to roaming mode 1, monitor mode. If all went well, you should now be scanning all the discovered P25 systems in your area.

4.4.3 ADD P25 SYSTEM

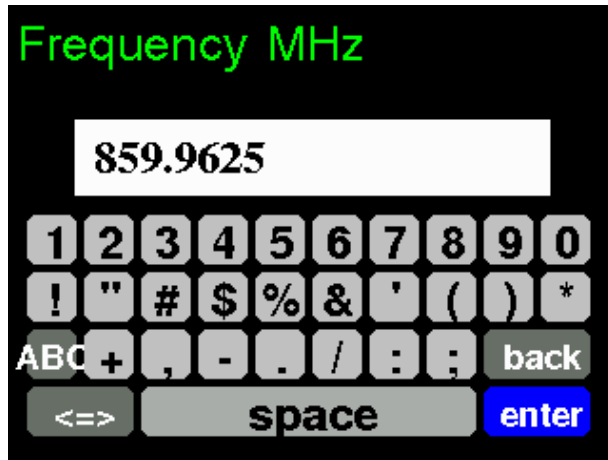

Add P25 System allows entering a known control channel frequency manually. The decimal is automatically added after entering the first three digits. After entering the frequency, the receiver tunes to the specified frequency and enables LEARN MODE in order to discover network configuration information transmitted by the control channel.

4.4.4 EDIT

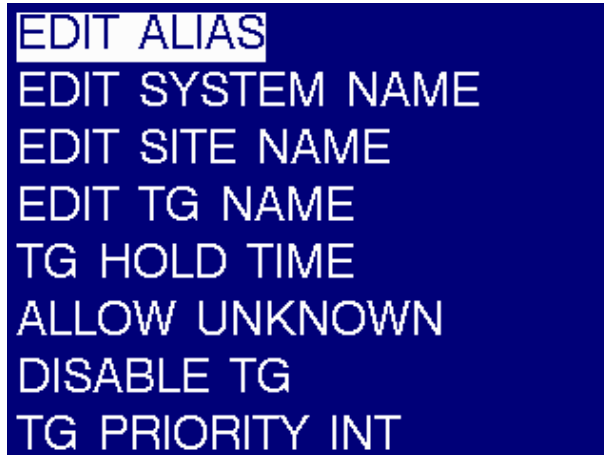

The **EDIT** menu is a general configuration parameter menu.

EDIT ALIAS – enter a text string to be associated with a particular radio ID. The RID / Alias is displayed on the bottom line of the display during a voice conversation.

EDIT SYSTEM NAME – Edit the name of the currently selected system. The system is associated with a control channel's unique value for WACN+SYS_ID. The system name is shown on the top-left of the display.

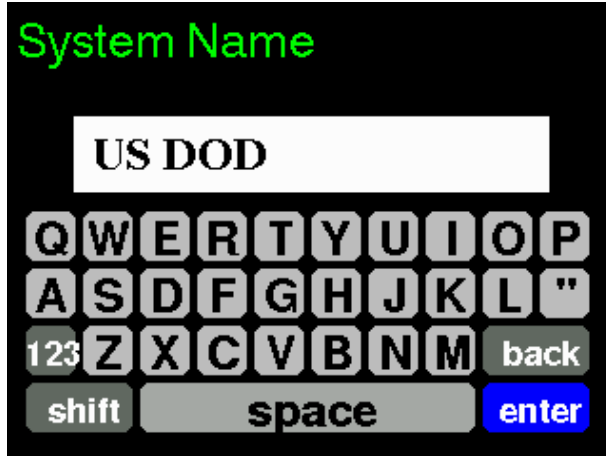

EDIT SITE NAME – Edit name of the currently selected SITE. The site is unique for WACN+SYS_ID+NAC+SITE_ID+RFSS_ID+FREQ_INDEX+RF_CH.

EDIT TG NAME – Edit the name of the most recent talk group. You must press the Configuration Menu button while the talk group is active. To use this option.

TG HOLD TIME – this option determines how long the currently active talk group will be followed after the conversation ends. This timeout does not expire based on tuned frequency. A conversation may be followed across multiple RF channels. Scanning will be paused for the duration of the TG hold period.

DISABLE TG – The disable talk group option will permanently disable the currently active talk group. The configuration menu button must be pressed while the talk group is active. The only way to re-enable the talk group is by editing a backup file and performing a restore or by re-importing the talk groups with the talk group enabled. To temporarily disable a talk group, see the **SKIP TG** button when in monitor mode.

TG PRIORITY INT Enable / Disable talk group priority interrupts. TG INT PRI will be display on the top line of the display and a short 440 Hz tone will be heard during a talk group priority interrupt event. Adjusting priority levels can be done by editing the backup file and performing a restore or by importing talkgroups with the priorities adjusted in the talk group file. Talk group backup files from the P25RX and P25RX-II models can be used. For advanced users, the TG INT 440 Hz tone is optional and may be disabled by editing a backup file, followed by a restore function.

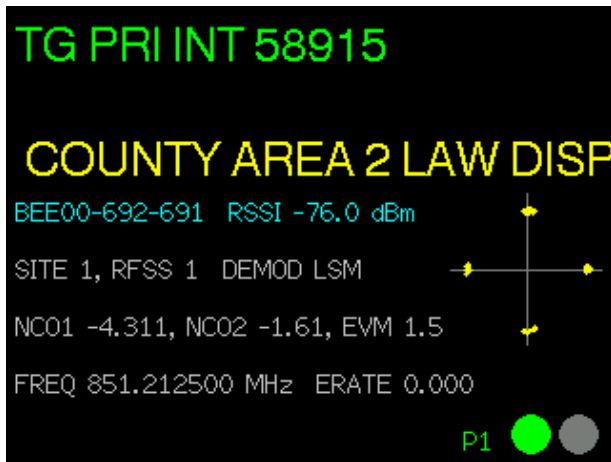

Figure 4: Talk Group Priority Interrupt During Voice Reception

4.4.5 SD CARD



Figure 5: uSD Card Options

CANCEL - No Action Return To CONFIG MODE Display

BACKUP – Create a 100% comprehensive backup of the receiver configuration to a file named microp25rx_backup.ini on the SD card. The backup is human readable and may be edited with a text editor or other software. To make a cloned receiver, a backup file transferred to another device, followed by the RESTORE function will result in a clone. See the appendix section for more information on the backup file format.

RESTORE

The restore function reads the microp25rx_backup.ini file located on the receiver uSD card. The REF_CALIBRATION value is only updated if the MAC ID of the device matches. The backup file may be safely restored on any receiver.

GEN SUMMARY REPORT

Creates a network summary report on the uSD card with a filename of network_summary.txt. Sample output:

```

SYSTEM NAME: BENTON 800
WACN (hex) : 0xBEE00
SYS ID (hex) : 0x34A

FREQ PLAN: IDX BASEFREQ BW SPACING TDMA_CH
IDEN_IDX=0, 851006250, 12500, 6250, 0
IDEN_IDX=1, 762006250, 12500, 6250, 0
IDEN_IDX=2, 851012500, 12500, 12500, 2
IDEN_IDX=3, 762006250, 12500, 12500, 2

SITE: 002 RFSS 001 NAC NA STATUS: (reported neighbor )
FREQ PLAN IDX 0 RF CHANNEL 1277 FREQ_HZ 858987500 DEMOD FM SITENAME SITE-002

SITE: 001 RFSS 001 NAC 0x340 STATUS: (verified active )
FREQ PLAN IDX 0 RF CHANNEL 1269 FREQ_HZ 858937500 DEMOD LSM SITENAME SITE-001C

SITE: 001 RFSS 001 NAC 0x340 STATUS: (verified active )
FREQ PLAN IDX 0 RF CHANNEL 1433 FREQ_HZ 859962500 DEMOD LSM SITENAME SIMULCAST

SITE: 001 RFSS 001 NAC 0x340 STATUS: (reported secondary)
FREQ PLAN IDX 0 RF CHANNEL 1273 FREQ_HZ 858962500 DEMOD LSM SITENAME SITE-001B

SITE: 001 RFSS 001 NAC 0x340 STATUS: (reported secondary)
FREQ PLAN IDX 0 RF CHANNEL 1429 FREQ_HZ 859937500 DEMOD LSM SITENAME SITE-001A

TALK GROUP COUNT 60
ALIAS COUNT 576

```

IMPORT TALK GROUPS

Supported talk group files include

- DSD-formatted talk group files available for download to subscribers on radioreference.com
- P25RX / P25RX-II talk group backup files (.csv)

All files on the uSD card that end with .csv, .dsd, .groups will be automatically detected and imported to the correct system based on the WACN + SYS_ID contained in the file. Note that the filename suffix is case sensitive and must be lower case. P25RX backup files must retain the header line with the field names in order to be detected.

IMPORT SITES

Supported talk group files include

- DSD-formatted site files available for download to subscribers on radioreference.com

All files on the uSD card that end with .sites will be automatically detected and imported to the correct system based on the WACN + SYS_ID contained in the file. Note that the filename suffix is case sensitive and must be lower case.

IMPORT ALIASES

Supported talk group files include

- .csv files with RID,ALIAS fields separated by a comma
- P25RX / P25RX-II alias backup files. e.g. p25rx_aliases.csv

All files on the uSD card with filenames of the form, alias-wwwww-sss.csv, where wwwwww is the WACN, and sss is the SYS ID of the system will be imported to the correct system based.

e.g. filename: **alias-bee000-123.csv**

DO SCREEN CAPS

When enabled, 320x240 RGB-888 screen captures of the LCD will be written to the uSD card on the **Wio Terminal Device** with the filename screencap.n, where 'n' is a number incrementing from 1 since last power-up. Existing files with the same name will be over-written. Most captures are triggered by pressing the joystick button (button mode select). There will be short, but noticeable delays as the captures are written to the uSD card. The ImageMagick convert utility can be used to convert the RGB captures to png files with the following:

```
convert -depth 8 -size 320x240+0 rgb:screencap.1 screencap1.png
```

4.4.6 FLASH CONFIG

CANCEL

No action taken. Return to display.

RESET TO DEFAULTS

This option will ask for confirmation. The flash memory file system will be re-formatted and all configuration information will be reset to factory default. Be sure to use the BACKUP option if you might need to recover your current configuration after the reset.

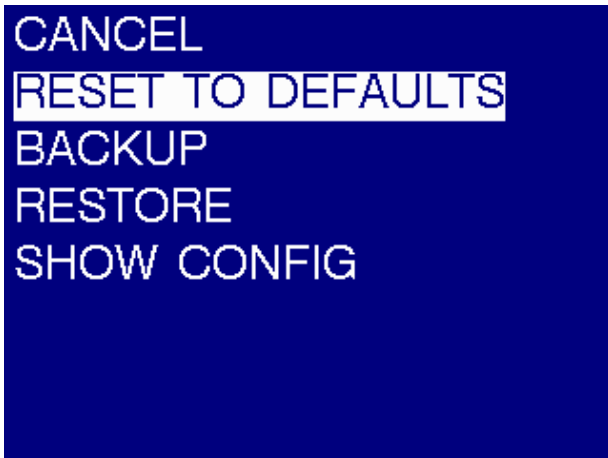

BACKUP (same as SD CARD → BACKUP)

Create a 100% comprehensive backup of the receiver configuration to a file named microp25rx_backup.ini on the SD card. The backup is human readable and may be edited with a text editor or other software. To make a cloned receiver, a backup file transferred to another device, followed by the RESTORE function will result in a clone. See the appendix section for more information on the backup file format.

RESTORE (same as SD CARD → RESTORE)

The restore function reads the microp25rx_backup.ini file located on the receiver uSD card. The REF_CALIBRATION value is only updated if the MAC ID of the device matches. The backup file may be safely restored on any receiver.

SHOW CONFIG

Show Config will show configuration information as illustrated in Figure 6. This display is only sent by the receiver to the display every several seconds. Press any key to exit the summary.

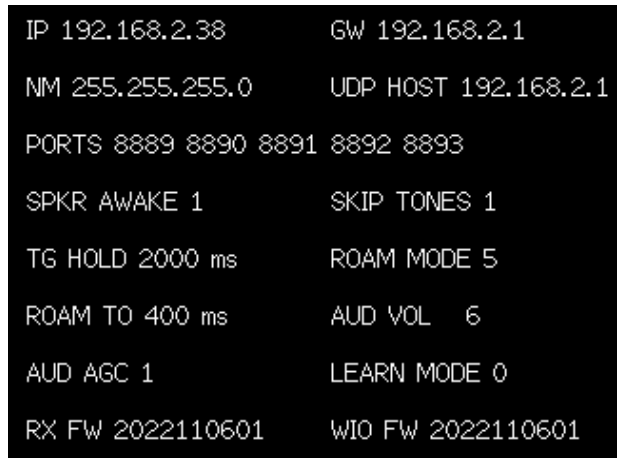

Figure 6: Show Config Summary

4.4.7 AUDIO

CANCEL

No Action Taken.

VOLUME

Audio volume selection for the 3.5mm audio jack. Ranges from -INF dB to +18 dB. The default NORMAL setting should be good for most applications including head phones.

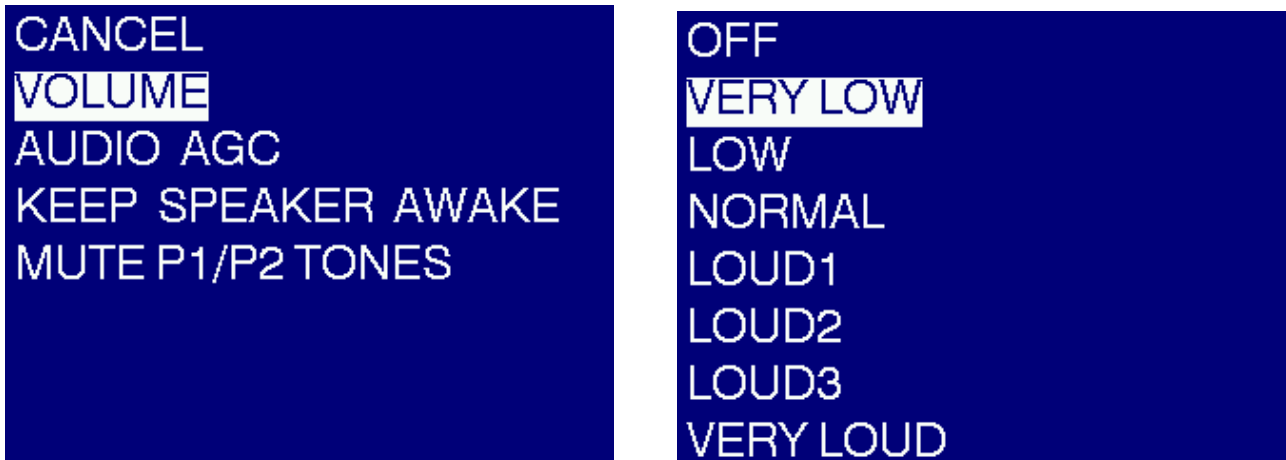

Figure 7: Audio Volume Configuration

AUDIO AGC

Enable / Disable the internal audio automatic-gain-control. Most users will want to leave this the default of enabled.

KEEP SPEAKER AWAKE

Many battery powered Bluetooth speakers will enter a sleep mode to conserve battery power. This feature doesn't work well when monitoring voice communications due to pauses in conversations. Enabling the keep-awake option will output low-level "Brownian noise" to the speaker in order to keep it awake. You probably won't even know it is enabled unless you have the speaker volume set very high. It is a very good solution and is enabled by default. If you are monitoring via line-in on a sound card or with ear buds, you might want to turn this option off for the maximum "quiet" between conversations.

MUTE P1/P2 TONES

Disable alert / emergency tones. This is known to work very well with P2 transmissions. The P1 option is known to work well on some systems, but is a new experimental option. Please report if you experience issues with it on a P1 system. This option is disabled by default.

4.4.8 ROAMING CONFIG

NOTE: Scanning only takes place when the device is in MONITOR MODE. If the device is in config mode, ROAM-PAUSE will be displayed.

MODE1 - SCAN ALL KNOWN PRIMARY

This scanning mode will scan all known active control channels when the device is in MONITOR MODE. These are control channels that have been monitored over the air by the receiver where the "LEARN MODE" was enabled and was able to record network / site configuration information to flash. This is the mode that is selected at the end of doing a "Zip Code Search". Active control channels are designated with a site-type of 'P' for primary in the backup file.

MODE2 - AUTO-SW ON SIG LOSS, P+S ALL SYS

This scanning mode will scan all known active channels and their reported secondary (backup) channels when the signal is lost. Once a valid signal is acquired, the receiver will park on the newly found active control channel until the signal is lost.

MODE3 - AUTO-SW ON SIG LOSS, SINGLE SYS

This scanning mode limits scanning to the currently selected / active system. The current WACN and SYS ID are written to the global configuration as ROAM3_WACN and ROAM3_SYSID. When the signal for the currently active control channel is lost, reported secondary sites or other primary sites associated with the system WACN+SITEID will be scanned until another active control channel is found. This is the mode for those that want to monitor a single system and have auto-switchover happen when the active control channel changes (HARRIS systems) or goes down due to outage.

MODE4 - AUTO-SW ON SIG LOSS, P+S+A ALL SYS

This scanning mode will scan ALL known primary, secondary, and adjacent sites it has learn from active control channels with the current active control channel signal is lost. It will scan until it finds another active control channel. This mode may be useful for those who are mobile and want to monitor a state-wide system over a wide coverage area.

MODE5 – SCAN USER SPEC INC_IN_SCAN=1

Scanning mode 5 is the most flexible scanning mode available for those who want to scan specific sites from a single or multiple systems. When roaming mode=5 and in CONFIG MODE, the top-left and top-right buttons enable / disable the “INC_IN_SCAN” configuration parameter associated with individual sites. When the INC_IN_SCAN option is enabled, an “S” indicator will be shown as in figure 8. The joystick left-right cycles through all known frequencies. Up/down cycles through secondary sites for the currently displayed primary.

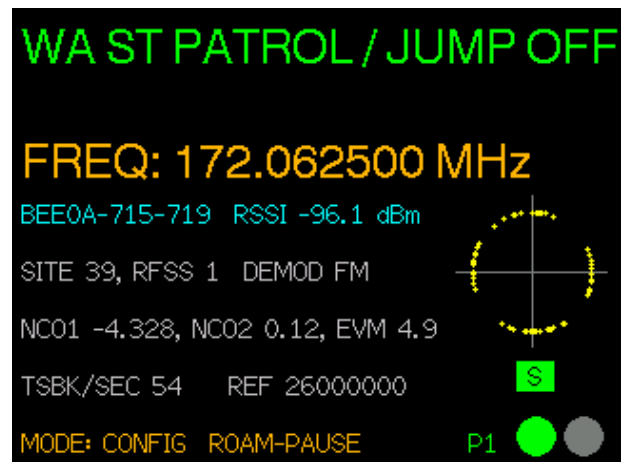
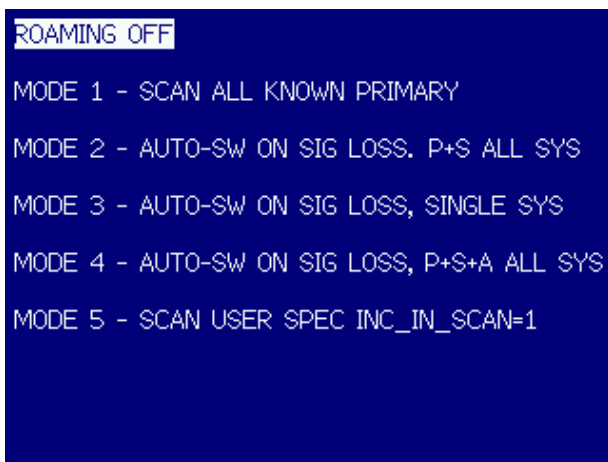
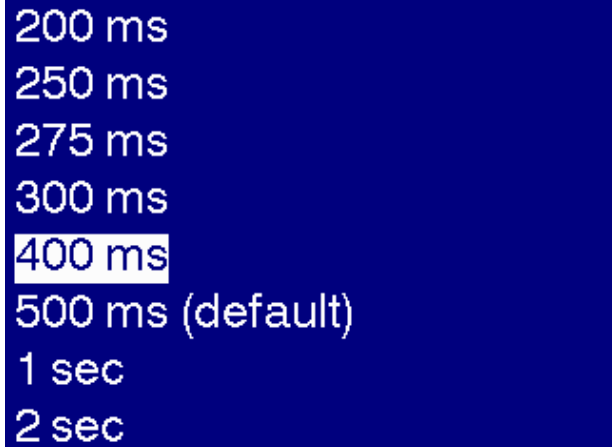

Figure 8: Scanning Paused In CONFIG MODE

4.4.9 ROAM TIMEOUT



200 ms
250 ms
275 ms
300 ms
400 ms
500 ms (default)
1 sec
2 sec

The roam timeout period determines the amount of time that the receiver will remain on the current control channel before moving to the next when scanning modes are enabled. The period is reset during active voice communications. Setting this value to less than the default of 500ms may result in some communications being lost if the signal for sites is marginal and several sites are in the scan list. Keep an eye on TSBK/SEC to help determine. For most situations, values between 300 and 500 are good values to start with.

5.0 Firmware Updates

5.1 Updating The Receiver Firmware

Download the **Teensy Loader Application** for your platform:
<https://www.pjrc.com/teensy/loader.html> Load the firmware update file **main.hex** using FILE → Open Hex File. Remove the Wio, and the cover from the enclosure. Press the programming button on the receiver. Select “Program” from the Operations menu. The message “Download Complete” will appear when the firmware has been updated. The firmware version can be verified on the Wio display under the CONFIG MODE → CONFIG MENU → FLASH → SHOW CONFIG

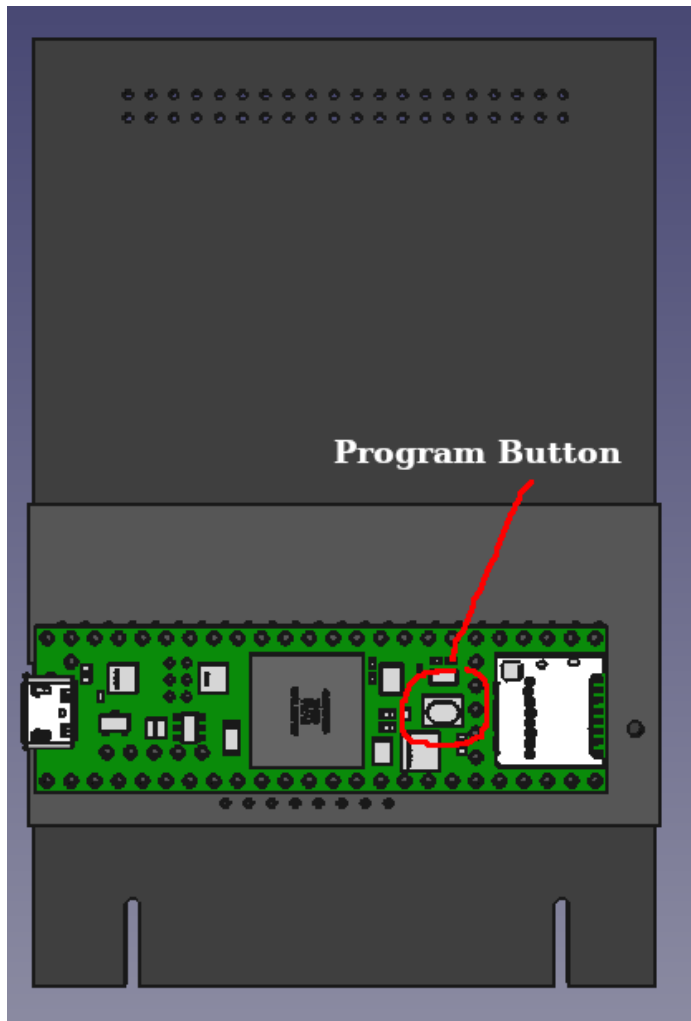

5.2 Updating The Display Firmware

You will need to remove the Wio terminal from the 40-pin connector and connect a USB Type-C connector to the Wio USB port. To install the updated Wio firmware, the Terminal must be in "bootloader" mode. Quickly slide the power switch down twice (like double clicking a mouse). The screen will be blank and the blue LED near the USB port should be "pulsing" when in bootloader mode. It may take a you few tries to get the power switch slide timing correct.

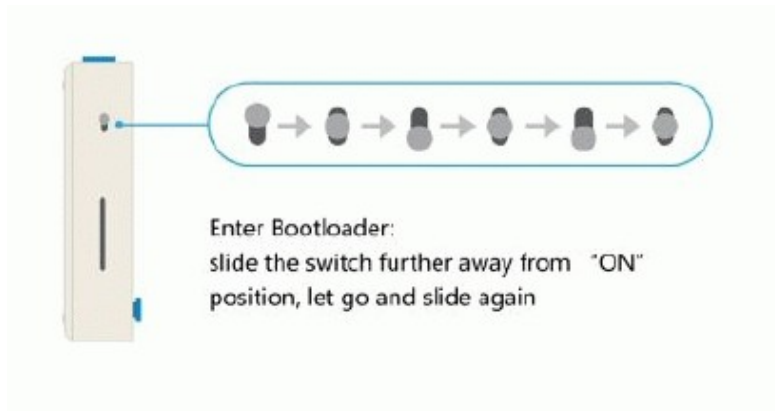

In bootloader mode, the Wio Terminal becomes a Mass Storage USB device (i.e. a flash drive). In Windows 10, look for a new external drive created called "Arduino". Inside this Arduino Folder there will be three files:

CURRENT.UF2, INDEX.HTM, and INFO_UF2.TXT



Copy the new firmware file **CURRENT.UF2** to this folder. Copying this file to the Arduino folder updates the firmware on the device. To reset the display device, slide the power switch down a single press (vs double-press to enter bootloader). The firmware version can be verified on the Wio display under the CONFIG MODE → CONFIG MENU → FLASH → SHOW CONFIG.

6.0 HW Connectors

6.1 Audio Jack

3.5mm stereo (L=R, mono output)

6.2 Antenna Connector

SMA Female

7.0 USB Connectors

Receiver – Micro-B. Provides power to the receiver and display. Updates to receiver firmware. Communications. (MUST BE A DATA CABLE)

Wio Terminal Display – Type-C. Needed when updating Wio Terminal firmware.

8.0 Receiver Specifications

(all specifications subject to change)

Parameter	Min	Typical	Max	Unit	Condition
Input Voltage (Vusb)	4.75	5	5.1	V	5V USB Power Supply
Supply Current		580		mA	With Display Attached
Sensitivity		0.8		uV	P25 Voice Decode
ACRR		49		dB	12.5 kHz offset
		54		dB	25 kHz offset
		58		dB	100 kHz offset
		68		dB	200 kHz offset
		73		dB	300 kHz
		82		dB	1 MHz
		88		dB	5 MHz
		90		dB	10 MHz
Frequency	130		512		MHz
	758		824		MHz
	849		869		MHz
	894		960		MHz
ADC RES		12-bits			
RF-IN S11	>12	>15		dB	450/770/850 bands Device Powered
3.5 mm Audio	32		Inf	Ohm	Drive ear-buds, head phones, powered speaker, sound-card line-in
RF-Z		50		Ohm	

9.0 Document History

2022-11-07	t.elliott	Rev 0	Document creation.
2022-11-13	goldmyne99	Rev 1	Added assembly instructions

10.0 Source Code

The github repository for the Wio Terminal Display source code for the MicroP25RX Wio Terminal Display is located here:

https://github.com/tvelliott/MicroP25RX_Wio

11.0 FCC Database and US Zip Code Files

These files can be downloaded from the BlueTail Technologies web site and placed on the MicroSD card on the receiver. These files are necessary for the Zip Code Search function to work.

Filename: us_zipcode.csv (US zip code database)

Filename: freqs.csv (FCC database)

Filename: freqs_user.csv (user created freq.csv file. Optional)

12.0 Troubleshooting

- **NO AUDIO FROM THE AUDIO JACK**
 - Is the AUDIO MUTE 'M' indicator being displayed? Disable Audio Mute
 - Are you using a battery powered speaker? Try enabling the KEEP SPEAKER AWAKE option to prevent the speaker from entering "sleep".
- **The receiver is not scanning. It just sits on a single frequency even though it is programmed to scan.**
 - Is the receiver in MONITOR button mode? A roaming/scanning mode must be selected and the receiver must be in the MONITOR button-mode for scanning to occur.

13.0 Appendix – Backup File Format

Each system defined has the following structure

[SYSTEM]

[ALIASES]

[IDEN] – multiple sections

[SITE] – multiple sections

[TALKGROUPS]

13.1 Note To Advanced Users

The backup file format described in this section is an ascii-based text file. It is designed to be easy-to-edit in a text editor. You can change any aspect of the receiver configuration by editing the backup “ini” file followed by the restore function.

13.2 [GLOBAL CONFIG] Section

[GLOBAL_CONFIG]

ALLOW_UNKNOWN_TALKGROUPS=1

TG_HOLDTIME=2000

AUDIO_VOL=6.0

AUDIO_AGC=1

SPEAKER_KEEP_ALIVE=1

MUTE_P25_TONES=1

LEARN_MODE=0

STARTUP_FREQUENCY=859.962500

EN_TG_PRI_INT=0

EN_TG_INT_TONE=1

IP_ADDR0=192

IP_ADDR1=168

IP_ADDR2=2

IP_ADDR3=38

NET_MASK0=255

NET_MASK1=255

NET_MASK2=255

NET_MASK3=0

```
GW_ADDR0=192
GW_ADDR1=168
GW_ADDR2=2
GW_ADDR3=1
UDP_HOST0=192
UDP_HOST1=168
UDP_HOST2=2
UDP_HOST3=1
UDP_PORT1=8889
UDP_PORT2=8890
UDP_PORT3=8891
UDP_PORT4=8892
UDP_PORT5=8893
TGZONE=15
ZONE1NAME=PD DISP
ZONE2NAME=PD C2C
ZONE3NAME=TAC
ZONE4NAME=FIRE
ZONE5NAME=DAT LRN
ZONE6NAME=MISC
ZONE7NAME=ENCRYPT
ZONE8NAME=ZONE8
ZONE9NAME=ZONE9
ZONE10NAME=ZONE10
ZONE11NAME=ZONE11
ZONE12NAME=ZONE12
ZONE13NAME=ZONE13
ZONE14NAME=ZONE14
ZONE15NAME=ZONE15
ZONE16NAME=ZONE16
DO_ROAMING=5
ROAMING_T0=400
ROAM3_WACN_HEX=BEE00
ROAM3_SYSID_HEX=14C
REF_CALIBRATION=04:E9:E5:12:86:BE,25999981
[END]
```

13.3 [SYSTEM] Section

```
[SYSTEM]
WACN=BEE00
SYSID=14C
[END]
```

13.4 [ALIASES] Section -per system

```
[ALIASES]
743802,AIRPORT26
743150,COUNTY101
741812,COUNTY12
741813,COUNTY21
741792,COUNTY23
741612,COUNTY24
[END]
```

13.5 [IDEN] Sections -per system

```
[IDEN]
IDEN_IDX=0
BASE_FREQ=851006250
BW=12500
SPACING=6250
TDMA_CH=0
[END]
```

```
[IDEN]
IDEN_IDX=2
BASE_FREQ=851012500
BW=12500
SPACING=12500
TDMA_CH=2
[END]
```

13.6 [SITE] Sections -per system

```
[SITE]
WACN=BEE00
SYSID=34A
NAC=340
TYPE=P
SITE=1
RFSS=1
IDEN_IDX=0
CHANNEL=1269
FREQ_HZ=858937500
DEM0D=0
SITENAME=SITE-001C
INC_IN_SCAN=0
[END]
```

```
[SITE]
WACN=BEE00
SYSID=34A
NAC=340
TYPE=P
SITE=1
RFSS=1
IDEN_IDX=0
CHANNEL=1433
FREQ_HZ=859962500
DEM0D=0
SITENAME=SIMULCAST
INC_IN_SCAN=1
[END]
```

13.7 [TALKGROUPS] Section -per system

```
[TALKGROUPS ENABLED,PRIORITY,TGRP,ALPHATAG,DESCRIPTION,ZONE]
1,1,317,RICHLAND,BENTON COUNTY,1
1,9,301,PASCO,FRANKLIN COUNTY,1
1,1,703,COUNTY_703_T,BENTON COUNTY,1
1,5,303,KENNEWICK,BENTON COUNTY,1
1,1,319,PROSSER,BENTON COUNTY,1
[END]
```

14.0 Enclosure Assembly

MicroP25RX Enclosure Assembly

Step 1: With the Wio Terminal removed from the Adapter Board, Slide the MicroP25RX PCB into enclosure at an angle and rotate the PCB down to sit inside the enclosure.

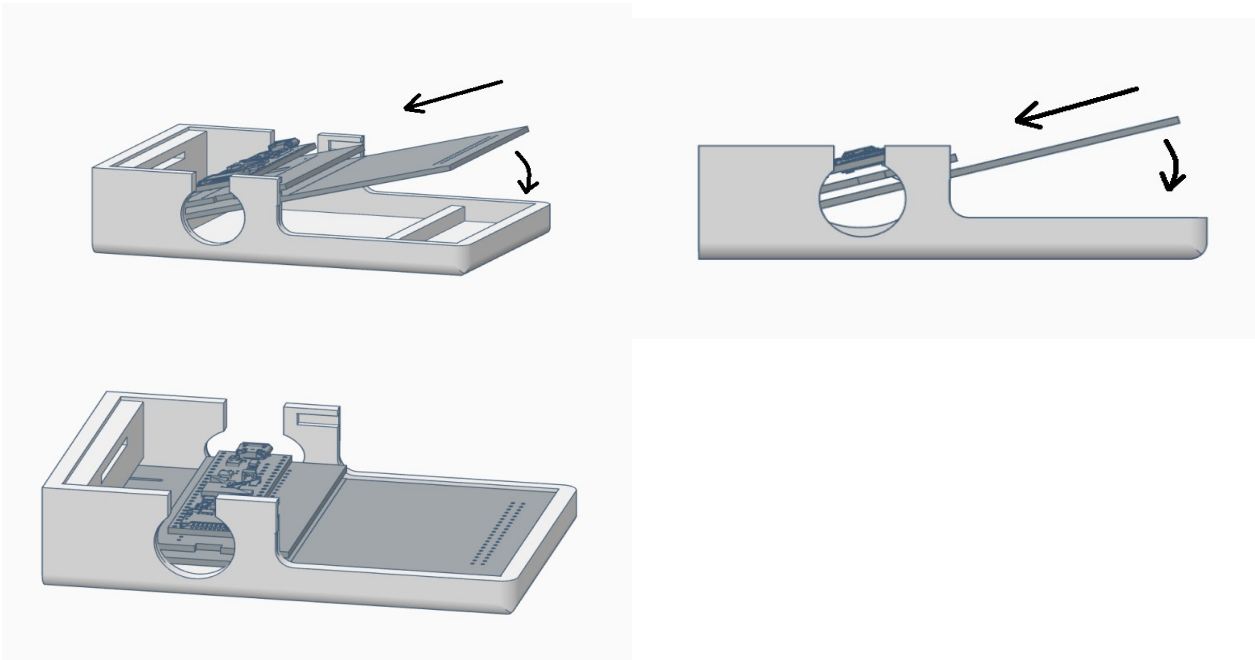

Step 2: With the MicroP25RX PCB inside the enclosure, slide the cover into the case. There are tabs on the cover that help secure the cover in place.

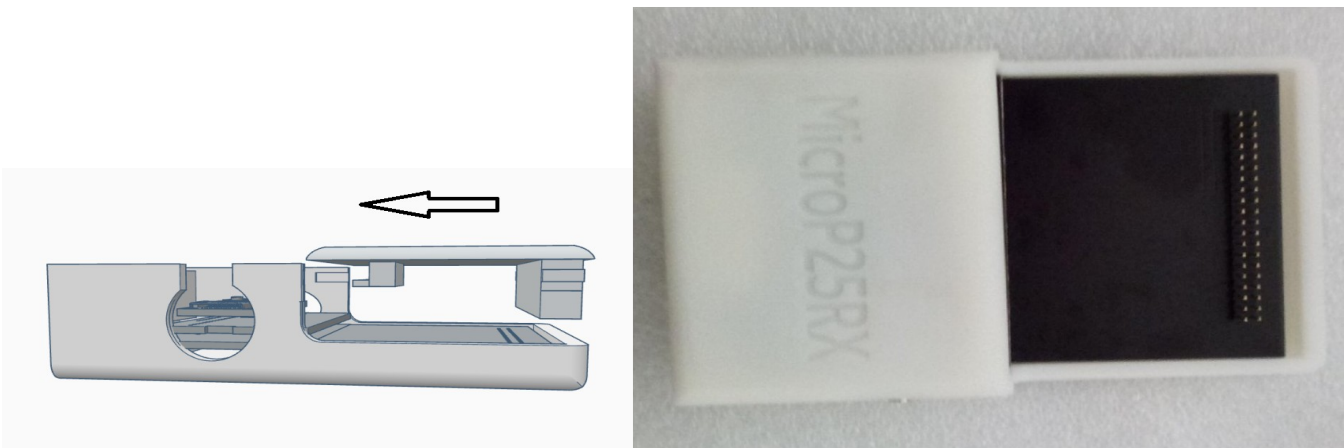

Step 3: With the cover in place, attach the Wio Terminal to the adapter board 40 pin GPIO connector.

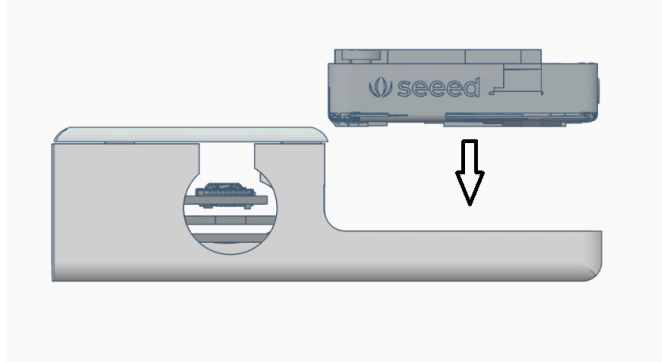

Assembled MicroP25RX inside enclosure with Wio Terminal attached .

