

IMPORTANT WARRANTY INFORMATION! PLEASE READ

Return Policy on Kits When *Not* Purchased Directly From Vectronics: Before continuing any further with your VEC kit check with your Dealer about their return policy. If your Dealer allows returns, your kit must be returned *before* you begin construction.

Return Policy on Kits When Purchased Directly From Vectronics: Your VEC kit may be returned to the factory *in its pre-assembled condition only*. The reason for this stipulation is, once you begin installing and soldering parts, you essentially take over the role of the device's manufacturer. From this point on, neither Vectronics nor its dealers can reasonably be held accountable for the quality or the outcome of your work. Because of this, Vectronics cannot accept return of any kit-in-progress or completed work as a warranty item for any reason whatsoever. If you are a new or inexperienced kit builder, we urge you to read the manual carefully and determine whether or not you're ready to take on the job. If you wish to change your mind and return your kit, you may--but you must do it *before* you begin construction, and within ten (10) working days of the time it arrives.

Vectronics Warrants: Your kit contains each item specified in the parts list.

Missing Parts: If you determine, during your pre-construction inventory, that any part is missing, please contact Vectronics and we'll send the missing item to you free of charge. However, *before* you contact Vectronics, *please look carefully* to confirm you haven't misread the marking on one of the other items provided with the kit. Also, make certain an alternative part hasn't been substituted for the item you're missing. If a specific part is no longer available, or if Engineering has determined that an alternative component is more suitable, Vectronics reserves the right to make substitutions at any time. In most cases, these changes will be clearly noted in an addendum to the manual.

Defective Parts: Today's electronic parts are physically and electrically resilient, and defective components are rare. However, if you discover an item during your pre-construction inventory that's obviously broken or unserviceable, we'll replace it. Just return the part to Vectronics at the address below accompanied with an explanation. Upon receipt, we'll test it. If it's defective and appears unused, we'll ship you a new one right away at no charge.

Missing or Defective Parts After You Begin Assembly: Parts and materials lost or damaged *after construction begins* are not covered under the terms of this warranty. However, most parts supplied with VEC kits are relatively inexpensive and Vectronics can replace them for a reasonable charge. Simply contact the factory with a complete description. We'll process your order quickly and get you back on track.

Factory Repair After You Begin Assembly: *Kits-in progress and completed kits are specifically excluded from coverage by the Vectronics warranty.* However, as a service to customers, technicians are available to evaluate and repair malfunctioning kits for a minimum service fee of \$18.00 (½ hour rate) plus \$7.00 shipping and handling (prices subject to change). To qualify for repair service, your kit must be fully completed, unmodified, and the printed circuit board assembled using rosin-core solder. In the event your repair will require more than an hour to fix (or \$36.00, subject to change), our technicians will contact you in advance by telephone before performing the work. Defective units should be shipped prepaid to:

Vectronics
300 Industrial Park Road
Starkville, MS 39759

When shipping, pack your kit well and include the minimum payment plus shipping and handling charges (\$25.00 total). No work can be performed without pre-payment. Also, provide a valid UPS return address and a day time phone number where you may be reached.

INTRODUCTION

This inexpensive transceiver kit provides a great first introduction to QRP operation, one of the hottest and fastest growing activities in amateur radio. When you build it, you'll discover what thousands of QRP enthusiasts already know--it doesn't take a degree from MIT to "homebrew" a rig that works! Indeed, all it takes are a few simple tools and a couple relaxing evenings of your time. And, once you complete it, you'll quickly unseat another myth--that it takes a \$1000 radio to work DX. The VEC QRP-CW Transceiver Kit is simple to build and even easier to align. VXO frequency control and broadband transmitter circuitry eliminate the need for costly alignment equipment or tricky calibration procedures. Connect an antenna, peak the receiver's front-end trimmer, and you're ready to go! You'll get microvolt sensitivity and a solid QRP CW signal with shaped keying. Best of all, you'll experience the excitement of working other stations using a simple home-built rig you made with your own two hands!

TOOLS AND SUPPLIES

Construction Area: Kit construction requires a clean, smooth, and well-lighted area where you can easily organize and handle small parts without losing them. An inexpensive sheet of white poster board makes an excellent construction surface and provides protection for the underlying table or desk. Well-diffused overhead lighting is a plus, and a supplemental high-intensity desk lamp is especially helpful for close-up work. Safety is always important! Be sure to use a suitable high-temperature stand for your soldering iron, and keep the work area free of combustible clutter.

Universal Kit-building Tools: Although your particular kit may require additional items for completion, virtually all construction projects require a work area outfitted with the following tools and supplies.

- 30 to 60 Watt Soldering Iron
- High-temperature Iron Holder with Moist Cleaning Sponge
- Rosin-core Solder (thin wire size preferred, .031")
- Needle Nose Pliers or Surgical Hemostats
- Diagonal Cutters or "Nippy Cutters"
- Solder Sucker (squeeze or vacuum pump type), or Desoldering Braid
- Bright Desk Lamp
- Magnifying Glass

Additional Items:

- RF power meter or VSWR bridge (or LED--any color)
- 50-ohm dummy load (or 1-watt 47 ohm carbon-film resistor)
- Telegraph key outfitted with a 1/4" monaural phone plug
- Headphones or extension speaker outfitted with a 1/4" monaural phone plug
- 13.8-v dc power source
- Antenna cut for band of operation

BEFORE YOU START BUILDING

Experience shows there are *four common mistakes* builders make. Avoid these, and your kit will probably work on the first try! Here's what they are:

- 1. Installing the Wrong Part:** It always pays to double-check each step. A 1K and a 10K resistor may look *almost* the same, but they may act very differently in an electronic circuit! Same for capacitors--a device marked 102 (or .001 uF) may have very different operating characteristics from one marked 103 (or .01uF).
- 2. Installing Parts Backwards:** Always check the polarity of electrolytic capacitors to make sure the positive (+) lead goes in the (+) hole on the circuit board. Transistors have a flat side or emitter tab to help you identify the correct mounting position. ICs have a notch or dot at one end indicating the correct direction of insertion. Diodes have a banded end indicating correct polarity. Always double-check--especially before applying power to the circuit!
- 3. Faulty Solder Connections:** Inspect for cold-solder joints and solder bridges. Cold solder joints happen when you don't fully heat the connection--or when metallic corrosion and oxide contaminate a component lead or pad. Solder bridges form when a trail of excess solder shorts pads or tracks together (see Solder Tips below).
- 4. Omitting or Misreading a Part:** This is easier to do than you might think! Always double-check to make sure you completed each step in an assembly sequence.

Soldering Tips: *Cleanliness* and good *heat distribution* are the two secrets of professional soldering. Before you install and solder each part, inspect leads or pins for oxidation. If the metal surface is dull, sand with fine emery paper until shiny. Also, clean the oxidation and excess solder from the soldering iron tip to allow maximum heat transfer. Allow the tip of your iron to contact both the lead

and pad for about one second (count "one-thousand-one") before feeding solder to the connection. Surfaces must become hot enough for solder to *flow smoothly*. Feed solder to the opposite side of the lead from your iron tip--solder will wick around the lead toward the tip, wetting all exposed surfaces. Apply solder sparingly, and do not touch solder directly to the hot iron tip to promote rapid melting.

Desoldering Tips: If you make a mistake and need to remove a part, follow these instructions carefully! First, grasp the component with a pair of hemostats or needle-nose pliers. Heat the pad beneath the lead you intend to extract, and pull gently. The lead should come out. Repeat for the other lead. Solder may fill in behind the lead as you extract it--especially if you are working on a double-sided board with plate-through holes. Should this happen, try heating the pad again and inserting a common pin into the hole. Solder won't stick to the pin's chromium plating. When the pad cools, remove the pin and insert the correct component. For ICs or multi-pin parts, use desoldering braid to remove excess solder before attempting to extract the part. Alternatively, a low-cost vacuum-bulb or spring-loaded solder sucker may be used. Parts damaged or severely overheated during extraction should be replaced rather than reinstalled.

Work Habits: Kit construction requires the ability to follow detailed instructions and, in many cases, to perform new and unfamiliar tasks. To avoid making needless mistakes, work for short periods when you're fresh and alert. Recreational construction projects are more informative and more fun when you take your time. Enjoy!

Sorting and Reading Resistors: The electrical value of resistors is indicated by a color code (shown below). You don't have to memorize this code to work with resistors, but you do need to understand how it works:

Resistor Color Code		
	Black = 0 (tens)	Blue = 6
	Brown = 1 (hundreds)	Violet = 7
	Red = 2 (K)	Gray = 8
	Orange = 3 (10K)	White = 9
	Yellow = 4 (100K)	Silver = 10%
	Green = 5 (1Meg)	Gold = 5%

When you look at a resistor, check its multiplier code first. Any resistor with a black multiplier band falls between 10 and 99 ohms in value. Brown designates a value between 100 and 999 ohms. Red indicates a value from 1000 to 9999 ohms, which is also expressed as 1.0K to 9.9K. An orange multiplier band designates 10K to 99K, etc. To sort and inventory resistors, first separate them

into groups by multiplier band (make a pile of 10s, 100s, Ks, 10Ks, etc.). Next, sort each group by specific value (1K, 2.2K, 4.7K, etc.). This procedure makes the inventory easier, and also makes locating specific parts more convenient later on during construction. Some builders find it especially helpful to arrange resistors in ascending order along a strip of double-sided tape.

Some VEC kits may contain molded chokes which appear, at first glance, similar to resistors in both shape and band marking. However, a closer look will enable you to differentiate between the two--chokes are generally larger in diameter and fatter at the ends than resistors. When doing your inventory, separate out any chokes and consult the parts list for specific color-code information.

Reading Capacitors: Unlike resistors, capacitors no longer use a color code for value identification. Instead, the value, or a 3-number code, is printed on the body.

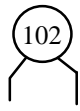
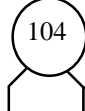
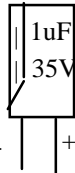
Value	Code			
10 pF	= 100			
100 pF	= 101			
1000 pF	= 102			
.001 uF	= 102*			
.01 uF	= 103			
.1 uF	= 104			
		Multilayer (270 pF)	Ceramic Discs (.001 uF) (.1 uF)	
				
				Electrolytic 1 uF
				

As with resistors, it's helpful to sort capacitors by type, and then to arrange them in ascending order of value. Small-value capacitors are characterized in pF (or pico-Farads), while larger values are labeled in uF (or micro-Farads). The transition from pF to uF occurs at 1000 pF (or .001 uF)*. Today, most monolithic and disc-ceramic capacitors are marked with a three-number code. The first two digits indicate a numerical value, while the last digit indicates a multiplier (same as resistors).

Electrolytic capacitors are always marked in uF. Electrolytics are polarized devices and must be oriented correctly during installation. If you become confused by markings on the case, remember the uncut negative lead is slightly shorter than the positive lead.

Diodes: Diodes are also polarized devices that must be installed correctly. Always look for the banded or cathode end when installing, and follow instructions carefully.

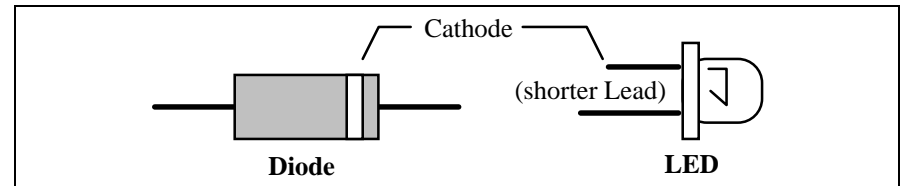

Transistors: If transistors are installed incorrectly, damage may result when power is applied. Transistors in metal cases have a small tab near the emitter lead to identify correct positioning. Semiconductors housed in small plastic cases (TO-92) have an easily-identified flat side to identify mounting orientation. Many specialized diodes and low-current voltage regulators also use this type packaging. Larger plastic transistors and voltage regulators use a case backed with a prominent metal tab to dissipate heat (T-220). Here orientation is indicated by the positioning of the cooling tab.

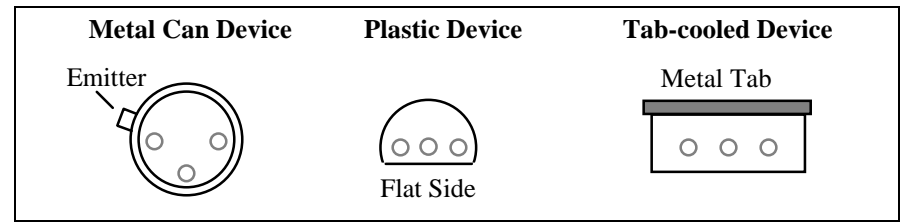

Integrated Circuits: Proper IC positioning is indicated by a dot or square marking located on one end of the device. A corresponding mark will be silk-screened on the PC board and printed on the kit's parts-placement diagram. To identify specific IC pin numbers for testing purposes, see the diagram below. Pin numbers always start at the keyed end of the case and progress counter-clockwise around the device, as shown:

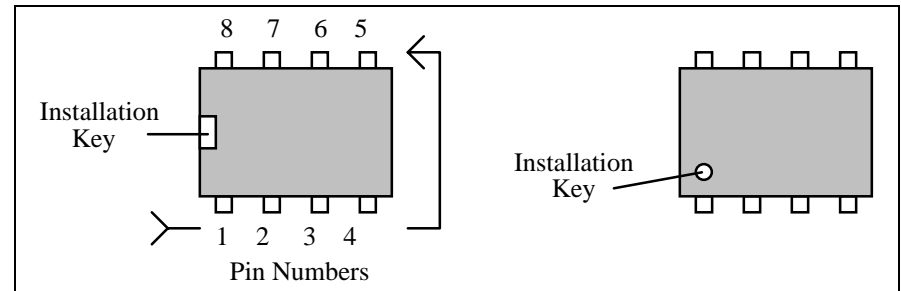

PARTS LIST

The parts list for your kit is presented in two parts. First, you'll identify and inventory the *generic* parts--those items common to *all* VEC QPR transceiver

kits regardless of band. Then you'll inventory a bag which contains *frequency-critical* parts that determine the specific band of operation.

If any parts are missing or damaged, refer to the manual's warranty section for replacement instructions. If you can't positively identify an unfamiliar item on the basis of the information given, set it aside until all other items are checked off. You may then be able to identify it by process of elimination. Finally, your kit will go together more smoothly if parts are organized by type and arranged by value ahead of time. Use this inventory as an opportunity to sort and arrange parts so you can identify and find them quickly during construction.

First, locate and identify the *generic* parts bags. These items are common to all four models of the VEC QRP-CW Transmitter Kit:

Capacitors:

<input checked="" type="checkbox"/>	Qty	Part Description	Designation	VEC P/N
<input type="checkbox"/>	7	.01 uF ceramic disc (103)	C17,C19,C21,C22, C26,C29,C31	200-2100
<input type="checkbox"/>	2	.05 uF ceramic disc (503)	C6,C12	200-2500
<input type="checkbox"/>	5	.1 uF ceramic disc (104)	C3,C8,C20,C30,C32	200-3100
<input type="checkbox"/>	3	1 uF electrolytic	C4,C5,C11	270-4100-2
<input type="checkbox"/>	1	10 uF electrolytic	C7	270-5100-1
<input type="checkbox"/>	2	100 uF electrolytic	C9,C10	270-6100-1
<input type="checkbox"/>	1	12-100 pF trimcap	C1	280-2100
<input type="checkbox"/>	1	multisection cap	C16	281-4010
<input type="checkbox"/>	1	tuning shaft	for C16	715-2520-0500

Resistors:

<input checked="" type="checkbox"/>	Qty	Part Description	Designation	VEC P/N
<input type="checkbox"/>	2	100 ohm (brown-black-brown)	R7,R11	100-2100
<input type="checkbox"/>	1	270 ohm (red-violet-brown)	R12	100-2270
<input type="checkbox"/>	1	470 ohm (yellow-violet-brown)	R4	100-2470
<input type="checkbox"/>	2	1K ohm (brown-black-red)	R3,R8	100-3100
<input type="checkbox"/>	2	3.3K ohm (orange-orange-red)	R2,R10	100-3330
<input type="checkbox"/>	3	10K ohm (brown-black-orange)	R5,R6,R14	100-4100
<input type="checkbox"/>	2	47K ohm (yellow-violet-orange)	R9,R13	100-4470
<input type="checkbox"/>	1	1K ohm potentiometer	R1	153-3100-1

Diodes:

<input checked="" type="checkbox"/>	Qty	Part Description	Designation	VEC P/N
<input type="checkbox"/>	2	1N4148 silicon switching diode	D1,D2	300-4148
<input type="checkbox"/>	1	1N4007 rectifier diode	D3	300-4007

Semiconductors:

<input checked="" type="checkbox"/>	Qty	Part Description	Designation	VEC P/N
<input type="checkbox"/>	1	2N3904 NPN transistor	Q1	305-3904
<input type="checkbox"/>	1	PN2222 NPN transistor	Q2	305-2222-1
<input type="checkbox"/>	1	2N3053 NPN transistor	Q3	305-3055
<input type="checkbox"/>	1	2N3906 PNP transistor	Q4	305-3906
<input type="checkbox"/>	1	SA602A IC	U1	325-0602
<input type="checkbox"/>	1	LM386 IC	U2	324-0386

Other:

<input checked="" type="checkbox"/>	Qty	Part Description	Designation	VEC P/N
<input type="checkbox"/>	2	T50-2 toroid (½" OD red)	T1,L4	403-1003
<input type="checkbox"/>	1	coaxial-type power jack	J1	601-6021
<input type="checkbox"/>	1	RCA jack	J2	600-0011
<input type="checkbox"/>	2	DPDT switch	SW1,SW2	504-0022
<input type="checkbox"/>	1	6" length of hookup wire		871-2499-0600
<input type="checkbox"/>	1	24" length of #22 wire		870-3022R
<input type="checkbox"/>	1	TO-5 heat sink	for Q3	750-0194
<input type="checkbox"/>	1	VEC-13xx Printed Circuit Board		861-1320
<input type="checkbox"/>	1	double-sided tape		781-6312

Now, to complete the inventory, select the list below for the *specific model of your kit*--and check off those items:

VEC-1320K 20-Meter Parts Package:

<input checked="" type="checkbox"/>	Qty	Part Description	Designation	VEC P/N
<input type="checkbox"/>	1	2.2 pF ceramic disc (2.2)	C13	200-00022
<input type="checkbox"/>	1	22 pF multilayer (22 or 220)	C15	200-0022
<input type="checkbox"/>	2	47 pF multilayer (47 or 470)	C2,C18	220-0047
<input type="checkbox"/>	1	68 pF multilayer (68 or 680)	C25	220-0068
<input type="checkbox"/>	3	220 pF multilayer (221)	C14,C27,C28	220-0220
<input type="checkbox"/>	1	330 pF multilayer (331)	C24	220-0330
<input type="checkbox"/>	1	470 pF multilayer (471)	C23	220-0470
<input type="checkbox"/>	2	1.8 uH choke (brown-gray-gold)	L2,L3	401-3180
<input type="checkbox"/>	1	3.3 uH choke (orange-orange-gold)	L1	401-3330
<input type="checkbox"/>	1	14.060 MHz crystal	Y1	414-06000

VEC-1330K 30-Meter Parts Package:

<input checked="" type="checkbox"/>	Qty	Part Description	Designation	VEC P/N
<input type="checkbox"/>	1	3.3 pF ceramic disc (3.3)	C13	200-00033-1
<input type="checkbox"/>	1	22 pF multilayer (22 or 220)	C15	220-0022
<input type="checkbox"/>	2	47 pF multilayer (47 or 470)	C2,C18	220-0047
<input type="checkbox"/>	1	100 pF multilayer (101)	C25	220-0100

<input type="checkbox"/>	3	330 pF multilayer (331)	C14,C27,C28	220-0330
<input type="checkbox"/>	1	470 pF multilayer (471)	C23	220-0470
<input type="checkbox"/>	1	680 pF multilayer (681)	C24	220-0680
<input type="checkbox"/>	2	2.2 uH choke (red-red-gold)	L2,L3	401-3220
<input type="checkbox"/>	1	3.3 uH choke (orange-orange-gold)	L1	401-3330
<input type="checkbox"/>	1	10.108 MHz crystal	Y1	410-10800

VEC-1340K 40-Meter Parts Package:

<input checked="" type="checkbox"/>	Qty	Part Description	Designation	VEC P/N
<input type="checkbox"/>	1	3.3 pF ceramic disc (3.3)	C13	200-00033-1
<input type="checkbox"/>	2	47 pF multilayer (47 or 470)	C2,C15	220-0047
<input type="checkbox"/>	2	100 pF multilayer (101)	C18,C25	220-0100
<input type="checkbox"/>	1	270 pF multilayer (221)	C14	220-0270
<input type="checkbox"/>	1	330 pF multilayer (331)	C23	220-0330
<input type="checkbox"/>	2	470 pF multilayer (471)	C27,C28	220-0470
<input type="checkbox"/>	1	1000 pF multilayer (1000)	C24	220-1010
<input type="checkbox"/>	3	4.7 uH choke (yellow-violet-gold)	L1,L2,L3	401-3470
<input type="checkbox"/>	1	7.040 MHz crystal	Y1	405-04000
<input type="checkbox"/>	1	24" length of #24 wire		870-3024G

VEC-1380K 80-Meter Parts Package:

<input checked="" type="checkbox"/>	Qty	Part Description	Designation	VEC P/N
<input type="checkbox"/>	1	4.7 pF ceramic disc (4.7)	C13	200-00047-1
<input type="checkbox"/>	1	68 pF multilayer (68 or 680)	C15	220-0068
<input type="checkbox"/>	1	100 pF multilayer (101)	C18	220-0100
<input type="checkbox"/>	1	180 pF multilayer (181)	C2	220-0180
<input type="checkbox"/>	2	470 pF multilayer (471)	C23,C25	220-0470
<input type="checkbox"/>	4	820 pF multilayer (821)	C14,C24,C27,C28	220-0820
<input type="checkbox"/>	3	10 uH choke (brown-black-black)	L1,L2,L3	401-4100
<input type="checkbox"/>	1	3.5795 MHz crystal	Y1	405-0107
<input type="checkbox"/>	1	24" length of #24 wire		870-3024G

Once again, if any parts are missing, consult the warranty page on the inside cover for specific replacement instructions. If your parts inventory is complete, you're ready to start building. Remember, once construction begins, you may no longer return your kit.

Many builders find it helpful to make a Xerox copy of the parts-placement diagram and the schematic diagram. These may then be posted in your work area for reference. A parts-placement layout is also printed on the circuit board to help you locate where to install each part.

PARTS PLACEMENT

Many builders find it helpful to make a Xerox copy of the parts-placement diagram and the schematic diagram . These may then be posted in your work area for reference. A parts-placement layout is also printed on the circuit board to help you locate where to install each part.

PARTS PLACEMENT

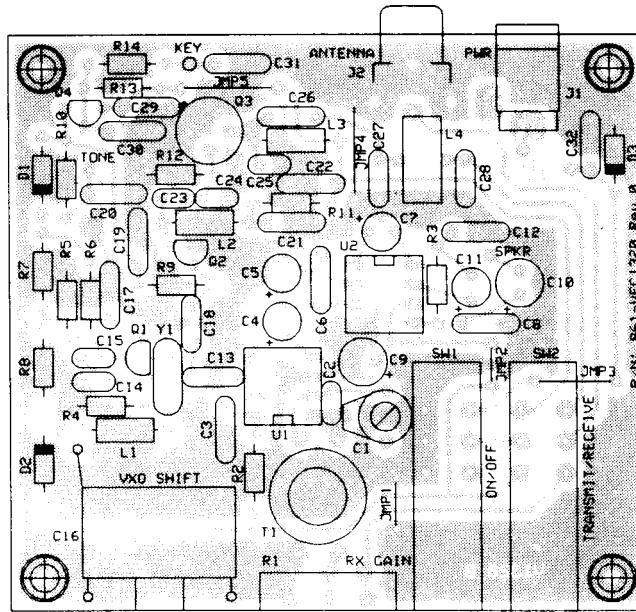

STEP-BY-STEP ASSEMBLY

Your transceiver kit will be constructed in three stages. First, you'll install the smaller *generic* parts (resistors, capacitors, etc.) that are common to all four models. Next, you'll mount *frequency-determining* components--those parts that determine the specific band of operation for your particular kit. Finally, you'll complete the project by installing larger *generic* parts such as jacks and switches--things that might get in the way if installed first.

In these instructions, when you see the term *install*, this means to locate, identify, and insert the part into its mounting holes on the pc board. This includes pre-bending or straightening leads as needed so force is not required to seat the part. Once a component is mounted, bend each lead over to hold it in place. Use sharp side-cutters to clip off excess lead length before soldering. Make sure trimmed leads don't touch other pads and tracks, or a short circuit may result:



The term *solder* means to solder the part's leads in place, and to inspect both (or all) solder connections for flaws or solder bridges. Nip off excess protruding leads with a sharp pair of side cutters.

Notice the directions use two sets of check boxes. Check one when a step is complete and use the other for double-checking your work before operation.

Stage 1: Small Generic Parts

This kit contains 13 fixed-value 1/4 watt resistors. Begin construction by mounting these first, starting with the smallest value and moving to the largest. Before installing each one, carefully bend both leads to form right-angles, as shown below:

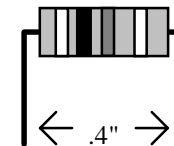

When installing resistors, save a few of the clipped-off lead ends--you'll need these for pc board jumpers later on.

Find two (2) 100 ohm resistors (brown-black-brown).

- 1. Install a 100 ohm resistor at R7 and solder.
- 2. Install a 100 ohm resistor at R11 and solder.
- 3. Find the 270 ohm resistor (red-violet-brown). Install at R12 and solder.
- 4. Find the 470 ohm resistor (yellow-violet-brown). Install at R4 and solder.

Find two (2) 1K resistors (brown-black-red).

- 5. Install a 1K resistor at R3 and solder.
- 6. Install a 1K resistor at R8 and solder.

Find two (2) 3.3K resistors (orange-orange-red).

- 7. Install a 3.3K resistor at R2 and solder.
- 8. Install a 3.3K resistor at R10 and solder.

Find three (3) 10K resistors (brown-black-orange).

- 9. Install a 10K resistor at R5 and solder.
- 10. Install a 10K resistor at R6 and solder.
- 11. Install a 10K resistor at R14 and solder.

Find two (2) 47K resistors (yellow-violet-orange).

- 12. Install a 47K resistor at R9 and solder.
- 13. Install a 47K resistor at R13 and solder.

This completes installation of the 13 fixed-value resistors supplied with the kit. Take a moment to inspect your solder connections and to confirm each resistor has been installed in the right pc board location. Next, you'll install the kit's 14 disc ceramic capacitors.

Locate seven (7) .01 uF disc ceramic capacitors (marked 103).

- 14. Install .01 uF at C17 and solder.
- 15. Install .01 uF at C19 and solder.
- 16. Install .01 uF at C21 and solder.
- 17. Install .01 uF at C22 and solder.
- 18. Install .01 uF at C26 and solder.
- 19. Install .01 uF at C29 and solder.

20. Install .01 uF at C31 and solder.

Locate two (2) .05 uF disc ceramic capacitors (marked 503).

21. Install .05 uF at C6 and solder.

22. Install .05 uF at C12 and solder.

Locate five (5) .1 uF disc ceramic capacitors (marked 104).

23. Install .1 uF at C3 and solder.

24. Install .1 uF at C8 and solder.

25. Install .1 uF at C20 and solder.

26. Install .1 uF at C30 and solder.

27. Install .1 uF at C32 and solder.

Your kit also contains six electrolytic capacitors. ***Electrolytic caps are polarized and must be installed the correct way in order to work.*** The capacitor's plus (+) mounting hole is noted on both the circuit board and parts placement diagram. If the markings on the capacitor body are unclear, the plus (+) lead is always the longer of the two.

Locate three (3) 1 uF electrolytic capacitors.

28. Install 1 uF at C4 and solder.

29. Install 1 uF at C5 and solder.

30. Install 1 uF at C11 and solder.

31. Find a 10 uF electrolytic capacitor. Install at C7 and solder.

Locate two (2) 100 uF electrolytic capacitors.

32. Install 100 uF at C9 and solder.

33. Install 100 uF at C10 and solder.

This completes capacitor installation for now. Take a moment to double-check capacitor location and electrolytic polarity. Electrolytics *must* be installed correctly in order to work. Also, note there are several fixed-value capacitors remaining in your kit. These will be installed later as *frequency-determining* parts. Finally, the VXO variable capacitor (C16) and adjustable trimmer (C1) will be installed last because of their larger size.

Now that you've accumulated a collection of nipped-off lead-ends, this is a good time to install the board's five (5) jumper leads. Each should be pre-formed prior

to installation, as shown below. The approximate distance between mounting holes is given for each to help you pre-form them. When installed, each jumper should lay flat against the PC board.

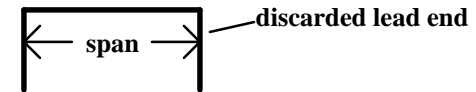

- 34. Form a .275" jumper and install at JMP1.
- 35. Form a .225" jumper and install at JMP2.
- 36. Form a .425" jumper and install at JMP3.
- 37. Form a .5" jumper and install at JMP4.
- 38. Form a .5" jumper and install at JMP5.

Save one additional resistor lead for connecting variable capacitor C16 later on.

Next, install the kit's transistors and diodes. ***Positioning of these parts is critical--they must be oriented correctly.***

- 39. Locate the 2N3906 transistor (black plastic case), checking identification markings closely. Find its flat side and align with the printed outline on the pc board before inserting the leads. Install the 2N3906 at Q4 and solder.

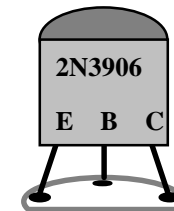

- 40. Locate a 2N3904 transistor (black plastic case). Install at Q1 and solder.
- 41. Locate a PN2222 transistor (black plastic case). Install at Q2 and solder.
- 42. Find the 2N3053 transistor (metal case). Install at Q3, inserting leads all the way so the metal case rests against the pc board surface. The metal "emitter" tab should point toward C29. Solder.

Locate two (2) 1N4148 diodes. The 1N4148 has a small glass body with a black band at one end. When installing, position this band to correspond with the marking on the pc board.

43. Install a 1N4148 at D1, observing the position of the band. Solder.

44. Install a 1N4148 at D2, observing the position of the band. Solder.

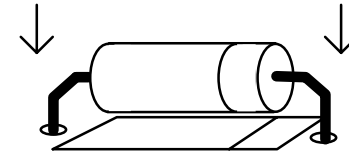

45. Locate the 1N4007 diode (larger body). Observing polarity, install at D3 and solder. Save the clipped-off lead ends--these will be installed to support VXO capacitor C16 later on.

Find U1, a NE602 8-pin IC (integrated circuit). Look for the markings "NE602AN", or other similar nomenclature such as "SA602". Note that the IC body has a small notch or dimple called a *installation key* molded at one end. Inspect and straighten any bent pins prior to installation.

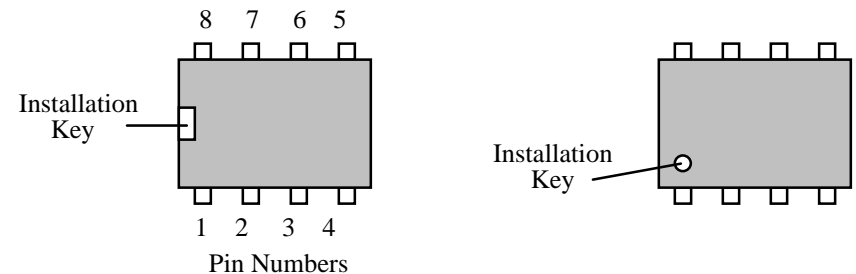

46. Align the NE602 so the installation key corresponds with markings on the pc board at U1. Carefully insert the pins into the mounting holes provided, seating the device firmly in place. Confirm all pins protrude through the board, and that none were bent over during insertion. The keyed end should be positioned toward the front of the pc board.

47. Solder U1.

48. Locate the LM386 Audio Amplifier IC. Identify the keyed end and carefully install at U2. The keyed end should be toward the back of the board.

49. Solder U2.

This concludes the first phase of construction (small generic parts). Next, you'll install frequency-determining components. However, before you start, this might be a good time to take a well-deserved break! Be sure to check transistor and diode positioning and polarity before moving on.

Stage 2: Frequency-Determining Parts

In this section, you'll select a *specific set of instructions for your particular kit*. However, before you do this, please review these two important general construction tips that apply to all four versions.

Installing Multilayer Capacitors: There are 9 multilayer capacitors in your kit. A multilayer cap is similar to a surface-mount "chip" capacitor, except that it has a lead spot-welded onto each end of the capacitor body. Each cap is then coated with an epoxy coating. Multilayers have superior radio-frequency operating characteristics, but the lead welds may fail if the leads are placed under stress while being heated during installation or removal. For this reason, *never use force to seat a multilayer cap* into the PC board. If the spacing isn't right, pre-form the leads to the correct spacing before installation!

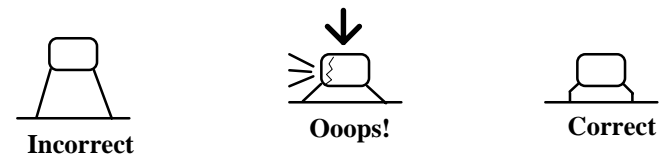

Winding T1 and L4: The receiver's pre-selector circuit and the transmitter's low-pass filter each use a high-Q toroid inductor wound on a T50-2 form (T50 means the form is .50" in diameter and 2 designates the "mix" of powdered iron used to make it). When winding toroid coils, remember *the number of turns are counted inside the form*. This means, if the instructions call for a 12-turn coil, you must pass the wire through the center of the core 12 times. When winding these coils, be sure to pull each turn up tight before starting the next. If the coil is wound loosely, inductance increases. At L4, this could reduce transmitter output power.

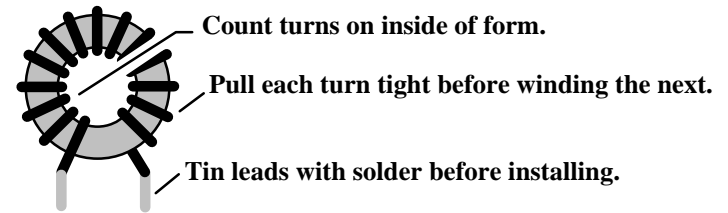

Before installing T1 or L4 on the pc board, be sure to tin both coil leads with solder. The coil wire provided with your kit is coated with heat-stripable enamel insulation that breaks down at soldering-iron temperatures. If you touch the tip of an iron to the end of the wire for several seconds, the insulation should start to melt, allowing solder to adhere to the copper underneath. If your iron isn't hot enough to start this process, carefully scrape off insulation with a small hobby knife before attempting to tin.

If necessary, refer back to these instructions at any time during assembly. You may now move ahead to the section of the manual that corresponds with your particular kit.

VEC-1320K 20-Meter Transceiver Kit

- 1. Find the 2.2 pF disc ceramic capacitor (2.2). Install at C13 and solder.
- 2. Find the 22 pF multilayer cap (marked 22 or 220). Install at C15 and solder.

Find two (2) 47 pF multilayer cap (47 or 470).

- 3. Install a 47 pF at C2.
- 4. Install a 47 pF at C18.
- 5. Find the 68 pF multilayer cap (68 or 680). Install at C25 and solder.

Find three (3) 220 pF multilayer caps (marked 221).

- 6. Install a 220 pF multilayer at C14 and solder.
- 7. Install a 220 pF multilayer at C27 and solder.
- 8. Install a 220 pF multilayer at C28 and solder.
- 9. Find the 330 pF multilayer cap (marked 331). Install at C24 and solder.
- 10. Find the 470 pF multilayer cap (471). Install at C23 and solder.

Locate two (2) 1.8 uH chokes (brown-gray-gold-silver or gold).

- 11. Install a 1.8 uH at L2 and solder.
- 12. Install a 1.8 uH at L3 and solder.
- 13. Find the 3.3 uH (orange-orange-gold-silver or gold). Install at L1 and solder.

Locate two T50-2 toroid coil forms (a donut-shaped part about ½" in diameter and color-coded red). Also, find the #22 enameled coil wire provided with your kit.

- 14. Wind twenty (20) turns of #22 enameled wire onto the T50-2 form. Note that turns are counted *inside* the form, and each turn is pulled tight before winding the next. Spread the windings out, distributing over 80% of the form's circumference.
- 15. Trim each coil lead to ½" in length and tin with solder.
- 16. Wind a two-turn secondary link of hook-up wire over the center portion of the primary winding (two turns passing through the center). Install at T1, laying flat--as shown below. Save unused portion of insulated wire--you will need 4" of insulated wire later.

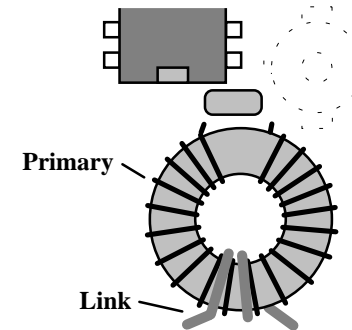

- 17. Solder T1 in place.
- 18. Wind 10 turns of #22 enameled wire on a T50-2 toroid form. Spread windings for 80% coverage, and install at L4 in an upright position.
- 19. Solder L4 in place.
- 20. Locate the 14.060 MHz crystal (metal can, two wire leads). Install at Y1 and solder.

This completes stage 2 construction of the VEC-1320K *20-meter kit*. After checking for errors, you may now move on to the final stage of construction.

VEC-1330K 30-Meter Transceiver Kit

- 1. Find the 3.3 pF disc ceramic capacitor (3.3). Install at C13 and solder.
- 2. Find the 22 pF multilayer capacitor (22 or 220). Install at C15 and solder.

Find two (2) 47 pF multilayer capacitors (47 or 470).

- 3. Install a 47 pF at C18 and solder.
- 4. Install a 47 pF at C2 and solder.
- 5. Find the 100 pF multilayer capacitor (101). Install at C25 and solder.

Find three (3) 330 pF multilayer capacitors (331).

- 6. Install a 330 pF at C14 and solder.
- 7. Install a 330 pF at C27 and solder.
- 8. Install a 330 pF at C28 and solder.
- 9. Find the 470 pF multilayer capacitor (471). Install at C23 and solder.
- 10. Find the 680 pF multilayer capacitor (681). Install at C24 and solder.

Find two (2) 2.2 uH molded chokes (red-red-gold-silver or gold)

- 11. Install a 2.2 uH at L2 and solder.
- 12. Install a 2.2 uH at L3 and solder.
- 13. Find the 3.3 uH molded choke (orange-orange-gold-silver or gold). Install at L1 and solder.

Locate two T50-2 toroid coil forms ($\frac{1}{2}$ " donut-shaped form, red color code). Also, find the #22 enameled coil wire provided with your kit.

- 14. Wind twenty-five (25) turns of #22 enameled wire onto the T50-2 form. Note that turns are counted *inside* the form, and each turn is pulled tight before winding the next. Spread the windings out, distributing over 80% of the form's circumference.
- 15. Trim each coil lead to $\frac{1}{2}$ " in length and tin with solder.
- 16. Wind a two-turn secondary link of hook-up wire over the center portion of the primary winding (two turns passing through the center).

Install at T1, laying flat--as shown below. Save unused portion of insulated wire--you will need 4" of insulated wire later.

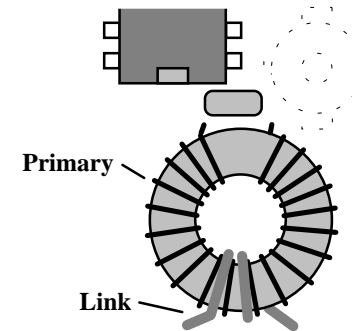

- 17. Solder T1 in place.
- 18. Wind 12 turns of #22 enameled wire on a T50-2 toroid form. Spread windings for 80% coverage, and install at L4 in an upright position.
- 19. Solder L4 in place.
- 20. Locate the 10.108 MHz crystal (metal can, two wire leads). Install at Y1 and solder.

This completes stage 2 construction of the VEC-1330K *30-meter kit*. After checking for errors, you may now move on to the final stage of construction.

VEC-1340K 40-Meter Transceiver Kit

- 1. Find the 3.3 pF disc ceramic capacitor (3.3). Install at C13 and solder. Locate two (2) 47 pF multilayer capacitors (47 or 470).
- 2. Install a 47 pF at C2 and solder.
- 3. Install a 47 pF at C15 and solder. Locate two (2) 100 pF multilayer capacitors (101).
- 4. Install a 100 pF at C18 and solder.
- 5. Install a 100 pF at C25 and solder.
- 6. Find the 270 pF multilayer capacitor (271). Install at C14 and solder.
- 7. Find the 330 pF multilayer capacitor (331). Install at C23 and solder.

Locate two (2) 470 pF multilayer capacitors (471).

- 8. Install a 470 pF at C27 and solder.
- 9. Install a 470 pF at C28 and solder.
- 10. Find the 1000 pF (or .001 uF) multilayer capacitor (102). Install at C24 and solder.

Find three (3) 4.7 uH molded chokes (yellow-violet-gold, silver or gold)

- 11. Install a 4.7 uH at L1 and solder.
- 12. Install a 4.7 uH at L2 and solder.
- 13. Install a 4.7 uH at L3 and solder.

Locate two T50-2 toroid coil forms ($\frac{1}{2}$ " donut-shaped form, red color code). Also, find the #24 enameled coil wire provided with your kit.

- 14. Wind thirty (30) turns of #24 enameled wire onto the T50-2 form. Note that turns are counted *inside* the form, and each turn is pulled tight before winding the next. Spread the windings out, distributing over 80% of the form's circumference.
- 15. Trim each coil lead to $\frac{1}{2}$ " in length and tin with solder.
- 16. Wind a two-turn secondary link of hook-up wire over the center portion of the primary winding (two turns passing through the center). Install at T1, laying flat--as shown below. Save unused portion of insulated wire--you will need 4" of insulated wire later.

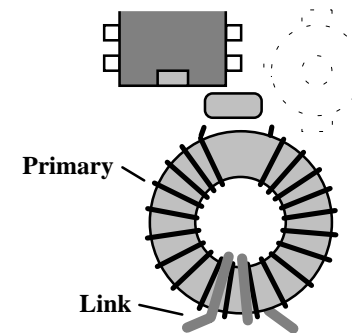

- 17. Solder T1 in place.

Find the #22 wire.

- 18. Wind 16 turns of #22 enameled wire on a T50-2 toroid form. Spread windings for 80% coverage, and install at L4 in an upright position.

- 19. Solder L4 in place.
- 20. Locate the 7.040 MHz crystal (metal can, two wire leads). Install at Y1 and solder.

This completes stage 2 construction of the VEC-1340 **40-meter kit**. After checking for errors, you may now move on to the final stage of construction.

VEC-1380K 80-Meter Transceiver Kit

- 1. Find the 4.7 pF disc ceramic capacitor (4.7). Install at C13 and solder.
- 2. Find the 68 pF multilayer capacitor (68 or 680). Install at C15 and solder.
- 3. Find the 100 pF multilayer capacitor (101). Install at C18 and solder.
- 4. Find the 180 pF multilayer capacitor (181). Install at C2 and solder.

Locate two (2) 470 pF multilayer capacitors (470).

- 5. Install a 470 pF at C23 and solder.
- 6. Install a 470 pF at C25 and solder.

Locate four (4) 820 pF multilayer capacitor (821).

- 7. Install a 820 pF at C14 and solder.
- 8. Install a 820 pF at C24 and solder.
- 9. Install a 820 pF at C27 and solder.
- 10. Install a 820 pF at C28 and solder.

Locate three (3) 10 uH molded chokes (brown-black-black-gold or silver).

- 11. Install a 10 uH choke at L1 and solder.
- 12. Install a 10 uH choke at L2 and solder.
- 13. Install a 10 uH choke at L3 and solder.

Locate two T50-2 toroid coil forms ($\frac{1}{2}$ " donut-shaped form, red color code). Also, find the #24 enameled coil wire provided with your kit.

- 14. Wind forty (40) turns of #24 enameled wire onto the T50-2 form. Note that turns are counted *inside* the form, and each turn is pulled tight before winding the next. Spread the windings out, distributing over 80% of the form's circumference.
- 15. Trim each coil lead to $\frac{1}{2}$ " in length and tin with solder.

16. Wind a three-turn secondary link of hook-up wire over the center portion of the primary winding (two turns passing through the center). Install at T1, laying flat--as shown below. Save unused portion of insulated wire--you will need 4" of insulated wire later.

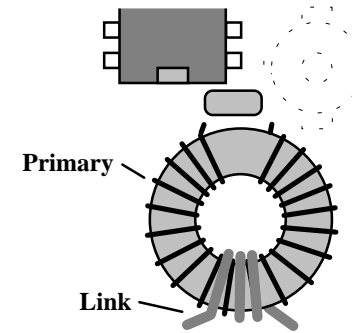

17. Solder T1 in place.
Find the #22 wire.
18. Wind 20 turns of #22 enameled wire on a T50-2 toroid form. Install at L4 in an upright position.
19. Solder L4 in place.
20. Locate the 3.579 MHz crystal (metal can, two wire leads). Install at Y1 and solder.

This completes stage-2 construction of the *80-meter kit*. After checking for errors, you may now move on to the final stage of construction.

Stage 3: Completing your Kit

During this final stage of construction, you'll install the remaining larger components. From now on, your transceiver will take shape very quickly!

Locate two (2) DPDT push-button switches.

1. Install a DPDT switch at SW1 and solder in place.

- 2. Install a DPDT switch at SW2 and solder in place.
- 3. Locate the 100 pF trimcap. Install at C1 and solder.
- 4. Locate the RCA pc mounted jack. Install at J2 and solder all tabs in place.
- 5. Locate the 2.1 mm DC power jack. Install at J1, seating the case flat against the surface of the pc board. Twist each solder tab slightly to secure the jack place, and solder all three.
- 6. Locate a length of insulated hook-up and prepare two (2) 2" lengths.
- 7. Install one wire at the "Key" pad and solder.
- 8. Install one wire at the "Speaker" pad and solder.

Find the plastic-encased variable capacitor. This is the transmitter's VXO tuning control (C16).

Locate the small strip of double-sided tape. Also, find the two heavy-gauge leads removed from the 1N4007 diode. These items will be used to secure C16 in place.

- 9. Using scissors or a hobby knife, cut a 1/2" by 3/4" square of double-sided tape. Install this within the box printed at C16 on the pc board (see diagram).

To orient the variable capacitor for installation, use the following diagram. There should be a ground tab to the left and right of the shaft. At the rear of the cap, a solder tab will protrude from the case at lower left. When the cap is positioned as shown, press it down onto the tape to secure it in place.

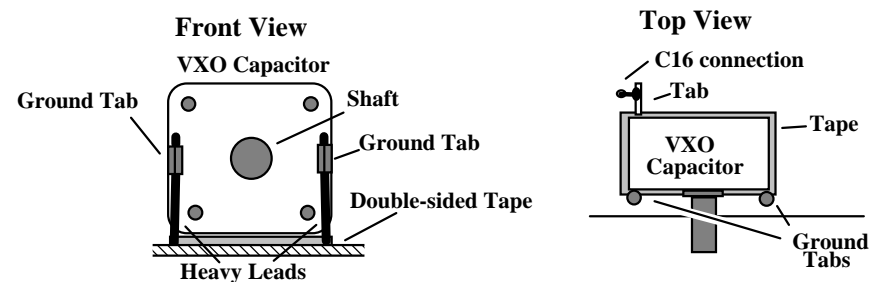

- 10. Install two (2) heavy leads (from the 1N4007 diode) from the ground tabs to the pads provided on the front of the pc board. Solder each lead at both ends. The combined holding action of the two-sided tape and the ground leads should anchor the cap firmly in place. Rotate the cap through its range--the capacitor should not shift position.

11. Find a resistor lead clipping. Install this between the C16 connection pad and the nearest solder-tab on the rear of C16. Solder at both ends.

Locate the 1K potentiometer. Before installing, inspect the type of potentiometer supplied with your kit. If the pins are located on the *front* side of the pot, use the *front set of mounting holes* on the PC board for installation. If the pins are on the *rear*, use the *rear set of mounting holes* (see following diagram). Also, using side cutters, remove the key tab from the side of the pot prior to installation.

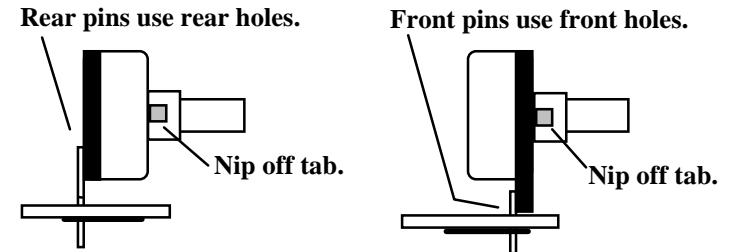

12. Install the 1K potentiometer at R1 and solder.
13. Find the tuning shaft for C16. Install using a small amount of contact cement or super glue.
14. Find the TO-5 type clip-on heat sink for Q4. Slip this over the 2N3053 transistor.

The custom enclosure for your VEC-13xxK kit (VEC-1300KC) includes two 1/4" monaural phone jacks for the key line and the speaker. Use the following steps to install the 1/4" jacks. If you have chosen to use your own jacks, now is a good time to connect them.

15. Locate two (2) 1/4" monaural phone jacks. Identify the plug-tip or center-connection terminal (as shown in following diagram).

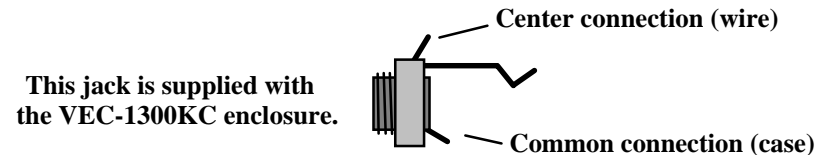

16. Identify the free end of the "key" hook-up wire. Connect to the center-connection terminal of one 1/4" jack.
17. Identify the free end of the "speaker" hook-up wire. Connect to the center-connection terminal of the other 1/4" jack.

Congratulations--this concludes construction your Vectronics QRP transceiver.

You deserve a well-earned break! When you come back, give your work a thorough "QC" quality-control check before moving on to the testing and alignment section.

TESTING AND ALIGNMENT

PC Board Inspection: Before applying power to your kit, give it a thorough QC (quality control) inspection. This will help you find inadvertent assembly errors that might prevent the radio from working or cause damage to sensitive parts. Follow this procedure:

- Compare parts locations against the parts-placement diagram. Was each part installed where it is supposed to be? Was the correct value used? Start at one side of the board and work your way across in an organized pattern.
- Inspect the solder side of the board for cold-solder joints and solder bridges between tracks or pads. Use a magnifying glass to obtain a clear view of the track area. If you suspect a solder bridge, hold the board in front of a bright light for a better view. All joints should be smooth and shiny, indicating good solder wetting and flow. Resolder any beaded or dull-appearing connections.

- Finally, check the electrolytic capacitor and diodes for correct polarity. Does the plus (+) polarity symbol on the part agree with the pictorial and with the pattern on the PC board? How about the diode bands? Were Q1-Q4 all installed correctly? Are the ICs installed the right way?

Be sure to correct all errors before moving on. If a careful inspection revealed that everything is OK, you're now ready for the moment of truth!

Tools and Materials Required for Testing:

Your VEC transceiver uses a "no-tune" design with only one adjustable alignment trimmer. However, to ensure everything is working correctly, you'll need to run some initial tests. This requires the following items:

1. **50-ohm dummy load:** A dummy load, or any 47 to 51 ohm *non-inductive* resistor capable of handling one watt, will provide a satisfactory transmitter termination for testing. Two (2) 100-ohm 1-watt metal oxide resistors (RadioShack 271-152) connected in parallel across a standard RF connector work well.

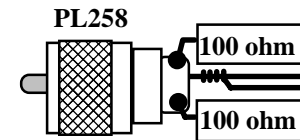

2. **Power Meter:** If you have access to a sensitive power meter, this will confirm the actual output power of your transmitter. If you don't have a wattmeter, a standard 5mm LED will provide a rough indication of RF output (see instructions).
3. **Telegraph Key:** The transmitter's keying circuit works with manual keys or electronic keyers. To plug in, you'll need a standard 1/4" monaural plug. Ground (or common) is connected to the plug's outer sleeve, and the key line is connected to the plug's tip.

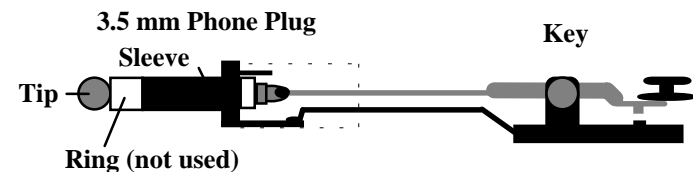

- 4. Power Supply:** Use any well-regulated 12-14 volt 500-mA DC (or 0.5 A) power source. Avoid using poorly-regulated or inadequately-filtered 12-volt wall-adapters. These can generate ripple on the CW note, and may even damage your kit if the unloaded output exceeds 15 volts. A fully-charged 12-volt battery is also a suitable power source, although transmitter output may be reduced slightly (RF output is specified at 13.8 volts).

The power jack supplied with your kit is a common 2.1-mm DC connector. The mating 5.0-mm OD x 2.1-mm ID plugs are available at your local RadioShack store (274-1567). Take care not to reverse-connect the power leads. ***The plus (+) or red power supply lead connects to the center pin, and the minus (-) or black lead connects to the outer sleeve.*** If your power wires aren't color-coded, confirm polarity with a voltmeter before installing the plug!



Important Note: In case of accidental reverse-power connection, your kit is protected against major damage by a "crowbar" diode (D1). However, activation will blow a "trace fuse" etched onto the circuit board next to the power connector. This must be replaced by a thin wire or a pig-tail type fuse before your kit will operate again (see "In Case of Difficulty").

- 5. RF Cables:** For a direct PL-238 transition, use a scanner adapter plug, catalog number 278-208 from Radio Shack. This "Motorola" adapter requires minor modification to work with RCA jacks. To modify, shorten the protruding center pin so that it extends about 1/8" beyond the outer sleeve of the plug using a fine-toothed hack-saw or hobby saw. De-burr and round off the end. The modified transition will now plug directly into RCA jacks.

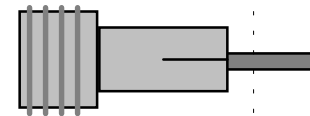

Cut pin here and round off end.

Test Set-up and Procedure:

To test your transceiver, set up as shown in the following diagram. Make sure the pc board is on a clean non-metallic surface free of lead-clippings, hardware, and other conductive debris that could get underneath and cause a short circuit. Before connecting the power supply, make sure the power switch (SW1) and T/R switch (SW2) are in the *out* position. If you have a station receiver available, place it in the CW mode and tune it to the transceiver's approximate operating frequency. This will enable you to monitor your transmitter's signal during testing. If any of the steps outlined below fail, refer to the "In Case of Difficulty" section of the manual.

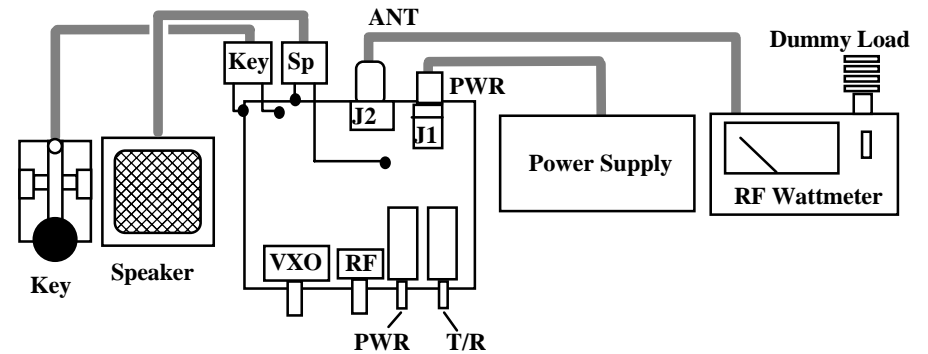

To test the radio outside of a metal case, you'll need to install temporary "ground" or "common" leads for the key and speaker jacks. Use temporary lengths of hookup wire or clipleads to make these connections. These may be attached to any convenient point on the pc board ground surface.

1. Install a temporary lead from the *key jack* "common" tab to pc board ground.
2. Install a temporary lead from the *speaker jack* "common" tab to pc board ground.
3. Press *power switch* SW1 to *ON*.
4. Turn *RF Gain* R1 fully clockwise--you should hear speaker background noise.

The next steps confirm transmitter operation. If you don't have access to a low-power RF wattmeter, install a standard 5 mm LED across the *antenna jack* (J2). Note that the antenna jack *must also be terminated with a 50-ohm dummy load*--the LED is not a substitute for a 50-ohm load. When transmitting, the LED should illuminate brightly at 1-2 watts output.

5. Press *T/R (transmit/receive)* switch (SW2) into the *transmit* position.

6. Press the key. The power meter (or LED) should indicate output of 1 watt or more.
7. Release the key--the output power should drop to zero.

If you have a station receiver available, tune it to the transceiver's operating frequency.

8. Set the *VXO* capacitor (C16) to mid-range.
9. Press the key and tune in the signal on your station receiver.
10. Vary *VXO* over its range. The signal should shift frequency by several kHz*.
11. Send a few CW characters. Keying should sound crisp and free of chirp.
12. Release the *T/R switch* to the *receive* position.

* The amount of frequency shift you obtain will depend on the band of operation. While 20-meter VXOs may vary by as much as 9 kHz, 80-meter VXOs will vary much less. If you note a "buzz" on the CW note, this *may* indicate poor power supply filtering--*or* may simply mean there's a ground-loop in your test set-up that won't affect your on-air signal. Obtain on-air reports to confirm hum or ripple observations.

To complete alignment and check-out, connect a low-VSWR antenna cut for the band of operation (2:1 or less). If you used a LED to test for RF output, remove it at this time. Under normal conditions, you should hear incoming signals with R1 advanced fully clockwise.

13. Using an insulated tuning tool, adjust *antenna* trimcap C1 for maximum sensitivity.

If strong signals overload the receiver, reduce R1 for comfortable listening and adjust more closely. The peak should be quite pronounced. Make sure you're peaking on amateur CW signals and not an out-of-band commercial radio station! This concludes the testing phase of construction. If your kit made the grade, you're ready for some serious QRP operating! If it didn't pass, please refer to the "In Case of Difficulty" section for suggestions that may help you isolate and solve the problem.

Sidetone: Your VEC QRP transceiver has provisions for powering a sidetone generator. To take advantage of this optional feature, obtain and install a low-cost piezo sounder such as the Radio Shack 273-065 (or equivalent). A pc pad for connecting the sounder's (+) lead is provided at "*Tone*" near Q4. The (-) lead goes to pc-board ground and may be connected at any convenient location. If

the sounder you select fails to operate due to low operating voltage, try substituting a lower-value resistor at R10. The sounder may be suspended above the pc board using stiff wire, or mounted at any convenient spot inside the cabinet. Also, it may be possible to lower the sounder's pitch by partially covering the sounder hole with masking tape.

VEC-1300KC Enclosure: Vectronics makes a custom enclosure especially drilled, punched, and labeled for your kit. If you purchased the VEC-1300KC, now is a good time to install it. Be sure to follow all installation instructions carefully.

Important Note: Federal Law requires that you possess a current FCC-issued Amateur Radio License of General Class or higher to operate a CW transmitter in amateur service.

OPERATION INSTRUCTIONS

Connecting Your QRP Transceiver:

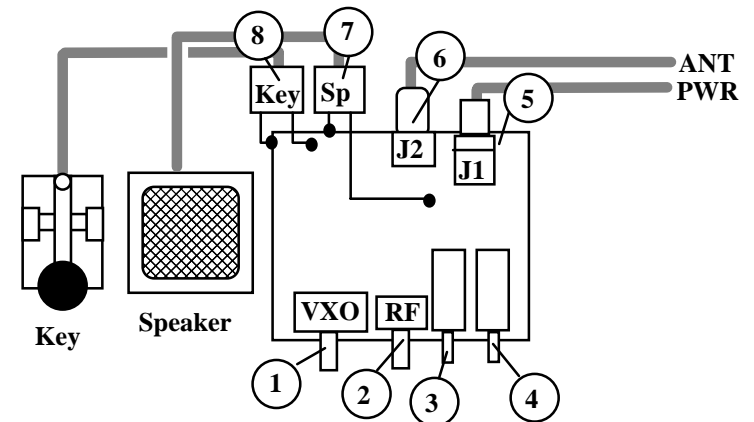

1. **VXO:** Varies oscillator above and below crystal's "cut" frequency.
2. **RF Gain:** Adjusts receiver signal levels to a comfortable listening level.
3. **Power Switch:** Applies power to the transceiver.
4. **T/R Switch:** Selects *transmit* mode (in) and *receive* mode (out).
5. **Power Jack:** 2.1x 5.0-mm, (+) to center (-) to sleeve, 12-14 V @ .5A
6. **Antenna Jack:** RCA, >1 watt of RF into 50-ohms, 3:1 VSWR or less.
7. **Speaker Jack:** 1/4" jack provides speaker or headphone AF output.

8. Key Jack: 1/4" jack accepts manual keys and most electronic keyers.

Antennas: QRP operation requires a good antenna, but you don't need stacked beams at 100' to get the job done! Most QRP enthusiasts use modest wire antennas that have been carefully installed and tuned for minimum VSWR. It's best to avoid compromised or severely shortened designs along with long lossy feedlines and inefficient matching schemes. Like most of today's solid-state radios, your transceiver uses a no-tune broadband output network designed to match into 50-ohm loads. While it can tolerate a wide range of mismatches, you'll get more usable power and better harmonic filtering with a low VSWR load.

Experience has shown that a full-sized 1/2 wave dipole or sloper installed as high as possible is hard to beat. The following chart suggests dipole wire lengths for various CW sub-bands. These dimensions are sensitive to ground conditions and near-by objects, so you may need to prune the length slightly to obtain minimum VSWR at your location. Information is also provided for adding a very low cost "choke" balun to your installation. A balun helps eliminate unwanted feedline radiation on transmit and noise pick-up on receive. Heavy-weight or premium cables are not required for QRP stations, and inexpensive RG58 is sufficient to do the job. The lighter your coax, the higher you can pull the center of your antenna.

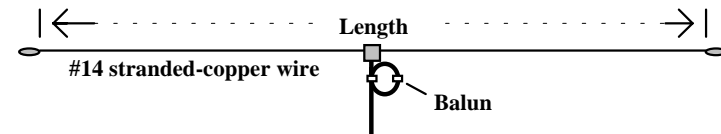

Band	MHz.	Length	Per-side	Balun
80	3.6	130' 0"	65' 0"	20'
40	7.1	66' 0"	33' 0"	14'
30	10.1	46' 4"	23' 2"	10'
20	14.05	33' 2'	16' 7"	8'

Balun consists of RG58 coiled 10" in diameter and held with tape or plastic tie-wraps

For additional antenna information on a wide variety of HF antennas, consult the ARRL Antenna Handbook, a publication of the American Radio Relay League in Newington, Connecticut.

QRP Operating Tips: Most QRP DXers agree the "hunt-and-pounce" method works best. Rather than spending a lot of time calling CQ, look for other stations calling CQ and answer them. Also, call stations that have just completed a QSO and signed. When you *do* call CQ, you can usually expect more replies around the QRP calling frequency where operators anticipate weaker signals. Finally, never hesitate to call weak stations--they may also be operating QRP or

may simply have poor transmitting antennas! You'll soon discover world-wide QRP contacts are routine. A growing legion of CW operators have QRP-DXCC certificates hanging on the wall to prove it!

IN CASE OF DIFFICULTY

Your VEC QRP-CW Transceiver has been thoroughly field-tested and is known to be reliable and "forgiving" of construction errors. If you have difficulty with your unit, the cause may be something as simple as a broken cable or a defective power source. In most cases, you will be able to find the problem with some organized troubleshooting. Begin your search with this checklist of symptoms and remedies:

Does not power up: Check the condition of your power source and connecting cable. Also, check supply polarity, direction of D3, and inspect the fuse trace near J1.

Does not key: Check your key and plug. Also, check circuitry around Q4 for construction errors. Make sure Y1 is installed correctly. Listen for off-air signals in receive mode to confirm that Q1 is oscillating.

Weak Signal, no measurable output: Check for construction errors. Also, check polarity of D1 and D2. Vcc should be present on case of Q3.

Low Transmitter Output: Check transmitter capacitor values against parts list, and check number of turns on L4.

Severe chirp or motorboating on signal: Check component values around Q1, Q4. Check D1 and D2 for incorrect polarity or diode failure.

Transmitter remains on when unkeyed: Check polarity of D1,D2. Also, check Q4 and transmitter component values.

Receiver insensitive: Check setting of R1, tuning of C1, antenna connections.

AM foreign broadcast interference: Check resonant frequency of antenna, station grounding, etc. Turn down R1. Overload by powerful AM shortwave signals may be unavoidable with unidyned detectors under certain extremely-strong signal conditions.

Audio Oscillation: Check component values and capacitor polarity around U2. Also, reduce receiver gain (R1) on extremely strong signals.

VXO cap fails to shift frequency: Check L1, C16.

Blown Crowbar Fuse: Usually caused by reverse power connection or by a direct short circuit from Vcc to ground on the pc board. The etched copper fuse

may be replaced by a small 1-A pigtail fuse or by a short length of #32 enameled wire. Your kit will not power up until this is replaced.

Voltage Analysis: Voltage analysis is a great way to pinpoint circuit problems. To do this, you'll need a voltmeter or DVM. Clip the black lead (-) to ground and use the red (+) probe to check the DC voltage at each IC or transistor lead. Before making key-down transmitter readings, desolder and remove Y1 from the pc board to prevent the transmitter from generating RF while you're attempting to make DC voltage measurements. Receiver IC readings are made with the unit in *receive* mode. Compare your readings against the chart below. They should agree within 10-15%. If you observe one or more "bad" readings, this may mean the device you're checking is blown--or that an incorrectly-installed part is lurking near-by. Try using the schematic diagram to trace out the exact cause of the problem.

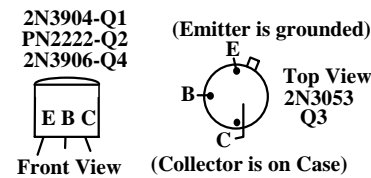

Important Note: Unit must not generate RF during these checks!

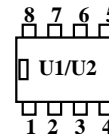

	Pin	1	2	3	4	5	6	7	8
NE602	U1	1.4	1.4	0	4.7	4.7	5.9	5.2	6.0
LM386	U2	1.4	.02	.01	0	6.7	13.8	7.0	1.4

VOLTAGE CHART

	Standby			Key-Down		
	E	B	C	E	B	C
Q1	0	0	0	5.7	6.3	12.6
Q2	0	0	13.8	0	.7	7.7
Q3	0	0	13.8	0	0	13.8
Q4	13.8	13.2	0	13.8	13.0	13.6

If these checks fail to uncover the problem, repeat the "QC" check one more time. Service records show that, for most malfunctioning kits, outright component failure is relatively rare. In most cases, the culprit is a misplaced part, reverse-polarized capacitor or diode, improperly installed transistor, or a faulty solder connection! If, despite your best effort, you cannot solve a problem with your radio, kit repair services are available through Vecronics. See the warranty on the inside front cover for complete instructions.

THEORY OF OPERATION AND SPECIFICATIONS

The transceiver consists of a simple direct-conversion receiver and a three-stage CW transmitter. Operating frequency is controlled by VXO (variable crystal oscillator) Q1. Q1 is keyed on and off during transmit mode by dc-switch Q4. During receive, it operates at reduced voltage which reduces mixer drive and

forces a frequency shift for CW offset. D1 and D2 isolate Q1's +T and +R voltage sources.

The RF input and AF output ports of unidyne detector U1 are configured for differential-mode to enhance common-mode noise rejection and provided highest gain. RF gain control (R1) and high-Q preselector (T1/C1/C2) precede the mixer input. AF output response is rolled off at high frequencies by C6.

U2 is a two-stage AF-power op-amp configured in high-gain mode by feedback capacitor C7. Loop-gain is further increased in the 600 Hz range by a second frequency-selective feedback network (R3/C11/C12). MUS (minimum usable sensitivity) exceeds 1 uV, while high-frequency AF products are rolled off for QRM reduction. U2 provides over 100-mW AF drive into 8 ohms, which is more than adequate to drive low-Z headphones and 8-ohm extension-type speakers.

In transmit mode, dc-switch Q4 provides shaped keying of VXO Q1 and supplies turn-on bias to driver Q2. PA Q3 operates in class-C and draws current only when RF drive is present. Broadband matching techniques are used to eliminate critical tune-up steps for the builder. A pi-section low-pass filter provides impedance matching and harmonic suppression between Q3 and the 50-ohm antenna port. CW output normally exceeds 1 Watt (+30 dBm) with -35 dBc or better harmonic suppression.

For simplicity, transceiver T/R functions are handled by a DPDT switch. A second switch applies power to the radio, and crowbar diode D3 protects transceiver circuitry against accidental reverse-polarity power connection. If "on-board" CW sidetone generation is required, a small powered peizo-sounder may be connected to key-switch Q4 through current-limiting resistor R10.

Typical Specifications:

RF power output: 1.2 watts @ 14 MHz (may be greater at lower frequencies)
Suppression: -35 dBc or better
VXO tuning range: 9 kHz typical at 14 MHz (will be less at lower frequencies)
VXO T/R offset: 300-500 Hz @ 14 MHz (will be less at lower frequencies)
Receiver sensitivity: .3 uV minimum usable signal on all bands
Receiver current: 25 mA at 13.8 Volts DC
Transmit current: 250-350 mA at 13.8 Volts DC

SCHEMATIC

ENCLOSURE

To install your transceiver in the VEC-1300KC matching enclosure follow these instructions (*read all instructions before beginning ... take your time*):

1. Find the front panel decal and rear panel decal; separate using scissors. Be sure to leave excess decal material around the edges. Put the rear panel decal on first. This is done by: **a.)** Remove all debris and oil from the chassis. This should be done using a piece of cloth and alcohol. **b.)** Remove the crack and peel to expose the adhesive. **c.)** Place the decal on the rear panel without securing it completely. **d.)** Gently rub the alignment circles with your finger--if the circles are centered in the enclosure holes (also check the corner alignment marks) secure the decal by rubbing and removing all air bubbles. **e.)** If the alignment circles are not centered, adjust the decal accordingly, then secure. **f.)** Use a penknife, or small Exacto™ knife, to cut away the unused edges (*cut from the adhesive side*) and cut out the component holes (*cut from the description side*). **g.)** Repeat this procedure for the front panel.
2. Next, install the two L-brackets on the chassis using two of the 3/16" screws. The longer side of the L-bracket *must be* connected to the chassis using the two holes centered on each edge of the enclosure. Refer to the diagram on the next page for location and orientation.
3. Install the four 1/2" mounting screws next. Insert the screws, from the bottom, through the four holes relatively close to each corner of the chassis.
4. Place the four 3/16" round spacers on the mounting screws.
5. Now insert the PC board. This must be done by: **a.)** Remove the nuts and washers from R1. **b.)** Insert the front of the PC board at an angle so the controls enter their respective holes. **c.)** Push down on the rear of the board. Make sure the mounting screws align with the mounting holes in the PC board before pushing.
6. Use the four hex nuts to secure the PC board. Be certain all appropriate components are centered with the enclosure holes before tightening. Put the washers and nuts--removed from R1--back on and tighten.
7. Find the knobs and switch caps. Align the red switch cap with SW1 and push it on. Repeat for SW2 with the black switch cap. If the caps are difficult to push on, then rotate them 90° and try again. Now put the knobs on R1 and C16. You may need to loosen the set screw. Align appropriately then tighten the set screws.
8. Locate the two 1/4" phone jacks, two silver washers, and two large nuts. Place a washer on the speaker jack and insert into the rear mounting hole labeled SPKR. Put one of the nuts on the jack and tighten. Repeat this process for the key jack and insert into the mounting hole labeled KEY.
9. Install the top now. Use the two remaining 3/16" screws for securing the top to the L-brackets. Make sure the L-brackets are aligned properly.
10. Finally, place the four rubber feet on the bottom of the enclosure at the corners.

