

Hy-Gain RAK1C by AlfaSpid Instruction Manual



This manual is for use with units sold by Hy-Gain as RAK1 and controller Rot1-Prog (RAK-1C). Units sold by others may have different firmware and may operate from different voltages. Current version and newer versions of this manual may be found on the internet at:

<http://www.hy-gain.com> or <http://www.alfaspid.com>

Last updated on September 5, 2008

Copyright AlfaRadio Ltd. 2002-2008

<http://alfaspid.com>

<http://www.hy-gain.com>

AlfaSpid_Rotator_AZ_2008-09-05_Manual_MFJ.doc

Table of Contents

Introduction	4
Shipping Contents.....	4
Technical Data	4
Control Panel	5
Rear Panel	6
Installation	7
Bench Testing.....	8
Resetting the Controller	9
Controller Operation.....	10
Function Mode.....	10
Normal Operations Mode	11
Half Auto Mode.....	11
Auto Mode	11
Preset Mode	11
Setup Mode	12
Programable High Limit.....	12
Programmable Low Limit.....	13
Programmable Reset Value	13
Preset 1 - 6.....	13
Mouse Controller.....	15
Using the AlfaSpid Rotator with LONG Cable Distances	18
Warranty	21
Notes	22

Introduction

The AlfaSpid rotator is an extra heavy-duty rotator designed to run large communication antennas and comes complete with an electronic control unit. The rotator is designed to be mounted pipe to pipe or on an optional adaptor plate for conventional in tower mounting. It can also be mounted outside of the tower on the mast, or used in a side mount configuration.

Shipping Contents

Rotator	1
Controller	1
.....	1
GMA Fuses.....	2
Optional	
Custom Mouse	1



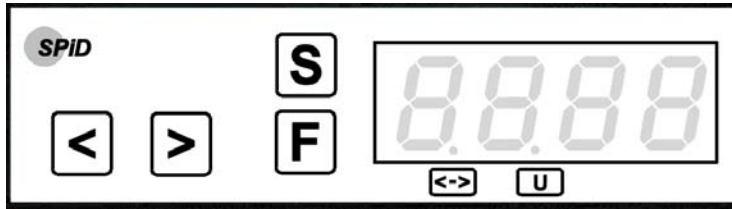

Technical Data

Input Voltage (Typical)	13.8 – 24 Volts DC
Input Current (Nominal Draw)	3 – 4 Amps
Motor	12 – 24 Volts DC
Fuse	8.0 Amp GMA
Rotation Speed	120 sec (12 V) / 60 sec (24 V)
Turning Torque (in lbs)	1400 (12 V) / 1740 (24 V)
Braking Torque (in lbs)	> 14,000



Control Panel



Buttons

-  -Left (Decrease)
-  -Right (Increase)
-  -Setup
-  -Function

Indicators

-  -Overlap
-  -Not currently used

7 segment 4-digit display

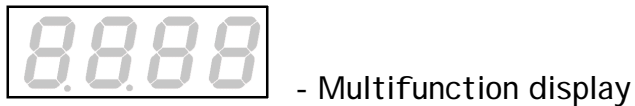

Rear Panel

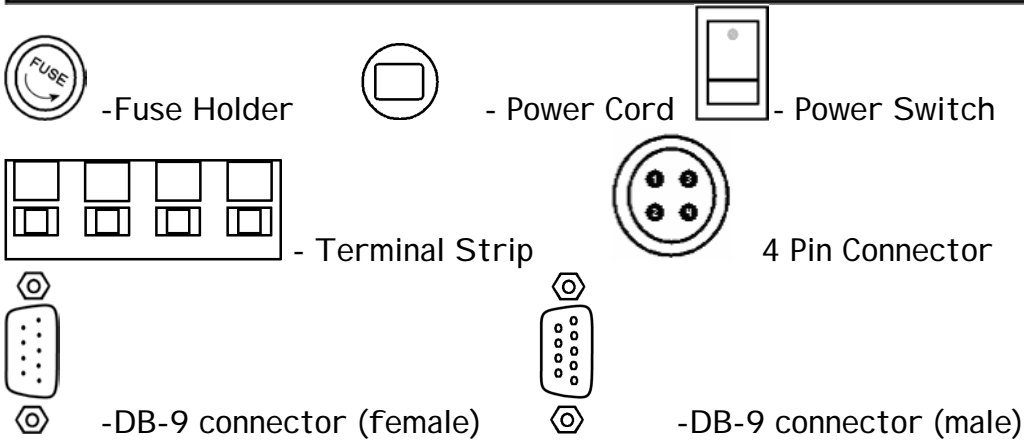
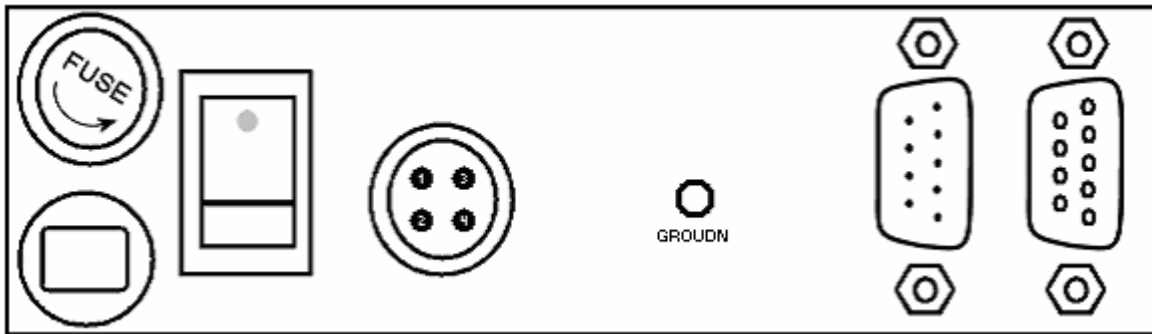
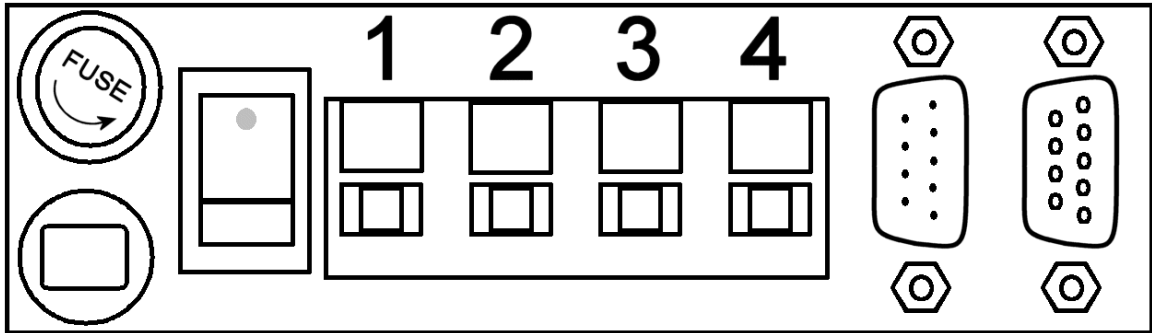

Female for CPU / RS232

Male for AlfaSpid Mouse

Installation

Wiring Connections

The rotator unit must be wired to the control unit with 4-wire cable. The gauge of the 4-wire cable to connect the control unit to the rotator depends upon the distance between rotator and controller. The wire for the impulse sensing may be quite thin - #22 or similar, even for relatively long distances.

<u>Length</u>	<u>Gauge Motor</u>
10 m (32')	#18 (1.19 mm)
30 m (100')	#16 (1.42 mm)
60 m (200')	#14 (1.75 mm)



CAUTION!:

Do not accidentally switch the motor wires with the impulse wires. Damage to the control unit may occur!

Remove cover from the motor body as shown and make connections as follows:

- 1 Motor Drive to 1 on controller terminal
- 2 Motor Drive to 2 on controller terminal
- 3 Impulse Sense to 3 on controller terminal
- 4 Impulse Sense to 4 on controller terminal

We suggest that the coax from the antenna be made with extra length to allow for the "Over Travel" 720 degrees in total. You may wish to also allow for the coax to come off the "South" side of the tower (180 degrees). See diagram last page of this manual.

Bench Testing of Control Box

The control box is normally expected to be operated from a 12 Volt DC supply; however it may be operated from other unregulated DC or AC sources as well. DC or AC voltage levels between 10 and 26 Volts capable of at least 5 Amps are acceptable, typically 12 or 14 Volts.

The polarity of the power to the control box input leads is not critical for D.C. operation; a diode rectifier on the input will provide the proper polarity to the electronics and provide reverse polarity protection as well as A.C. operation.

TIP: Because of several steering diodes in the motor path, the voltage delivered to the motor (neglecting wire loss) will be about 1.4 volts less than the power supply voltage. For longer runs and/or thin wiring a higher voltage (up to approx 24V) to the control unit may be beneficial. A simple way to estimate if the voltage to the motor is adequate is by timing the rotation. Under no or a very small load, the 360 degree rotation time with 12V DC at the motor is about 120 second (2 minutes). With 24 V DC is about 60 second (1 minute). A DC Ammeter in the motor lead is also useful, it should indicate between 1 and 3 amps with a small load. On windy days or heavy load, the current may fluctuate up to 3 to 5 amps.

Notes - testing and troubleshooting



It is highly recommended to ground the Control Box.

Pressing should make the rotator move clockwise. Pressing should make the rotator move counter-clockwise. If rotation is reversed, switch lines 1 and 2 on the back of the controller.

Impulse sense lines (3 & 4) have no polarity concerns.

Part of the protection circuitry involves removing motor power if the controller receives no sense indication. If the motor turns for a few seconds and then you hear the relay in the control box drop out, the motor has either stalled or there is a problem in the impulse sense wiring.

Resetting the Controller

Since there are no mechanical limits in the rotator, it may be installed with the antenna pointing in any direction. There is no reason to locate "TRUE NORTH" until you are ready to calibrate the control box. Use the controller to position the antenna to physically point north, then reset the controller as follows:

Turn the unit OFF. Then while holding the **F** button depressed turn control unit back on. This will now show **8888** on the display. The controller is now set for North.

Display adjustment:

Press the **S** button to cycle thru to the normal (i.e. blank) setting until you see the display after P5 X, (X is the mode for computer interface) It will be blinking. The display shows the normal degree reading i.e. 30 degrees, with the left or right arrows the display reading can be changed with out turning the rotator in this mode, this feature can be used if, for any reason, the direction of the antenna becomes incorrect. This may be caused by antenna to mast slippage or incorrect initial alignment. The Rotator to mast will not slip unless there is improper installation. See Heading Adjust (numbers blinking) else where in this document.

IMPORTANT:

The AlfaSpid rotator is now set at the counter-clockwise end of its normal rotation range. Normal rotation range is in a clockwise direction for 360 degrees.

From the reset position, you can rotate counter-clockwise an additional 180 degrees in over-travel, as well 360 degrees clockwise, plus an additional 180 degrees into clockwise over-travel.

Counter-clockwise over-travel is indicated by a steady dot above the over-travel icon. **<->** Rotation past 359 degrees into the clockwise over-travel is indicated by a blinking dot above the over-travel icon. **<->**

Technical Note:





Controller Operation

You will need to leave sufficient coax length to accommodate the additional 180 degrees of over-travel on each end of normal rotation. Failure to do so can cause damage to your coax and/or antennas.

The AlfaSpid controller has multiple modes of operation. You will need to become familiar with these modes to be able to make full use of your rotator.



F Function Mode

The **F** button steps through the function menus. The leftmost character on the display indicates the function mode you are currently in.



-  - Normal Operations Mode
-  - Half Auto Mode
-  - Auto Mode
-  - Preset Mode

 The "0" (Zero) in the displays to the left will be replaced by your actual beam heading



- Normal Operations Mode

In Normal Operations Mode, the  and  buttons cause rotation as long as the buttons are pressed. Pressing  while in normal operations mode will take you to setup mode.



- Half Auto Mode

In Half Auto Mode, the  and  buttons can be used to pre-select the desired beam heading. The heading displayed on the controller will rapidly change in the direction of desired rotation. Once the desired beam heading is shown on the display, release the key. Approximately ½ of a second after no key presses have been detected, the display will revert back to the actual beam heading, and rotation towards the desired heading will take place. Pressing any key while in transit to the desired heading will cancel the action.

- Auto Mode

In Auto Mode, the controller will respond to commands from control software running on an attached computer. The  and  buttons can still be used as a manual override.









- Preset Mode (requires optional mouse)

In Preset Mode, the  and  buttons cause rotation as long as the buttons are pressed. With the optional mouse attached, the six preset buttons can be used to select a desired beam heading. Preset beam heading values are set in Setup Mode

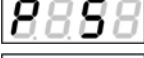
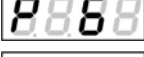
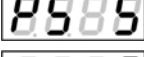

S Setup Mode

The **S** button steps through the setup menu. The display cycles through each of the setup menu items.

1.00 or 0.50 ratio setting (Default is 1.00) (May be 0.5 on Big RAK)



	- Programmable High Limit	Default flashing "DOT" 180
	- Programmable Low Limit	Default not flashing "DOT" 180
	- Programmable Reset Value	0 or 180
	- Preset 1	
	- Preset 2	
	- Preset 3	
	- Preset 4	
	- Preset 5	
	- Preset 6	
	- Program Simulation	
	- Heading Adjust (numbers blinking)	

- Programmable High Limit

The Programmable High Limit is a user adjustable clockwise travel limit value. By reducing this value, the maximum clockwise rotation travel can be restricted. Use the  and  buttons adjust the value.

These limits can be used when side mounting the rotor to keep the antenna from colliding with the tower.

 - Programmable Low Limit

The Programmable Low Limit is a user adjustable counter-clockwise travel limit value. By increasing this value, the minimum counter-clockwise rotation travel can be restricted. Use the  and  buttons adjust the value.

 - Programmable Reset Value

The Programmable Reset Value can be set to either 0 degrees, or 180 degrees. This is the beam heading set when a power on reset event is triggered. If you wish to reset your rotator to south, set this value to 180.

 - Preset 1

P1 Thru P6

 - Preset 6

These 6 presets are user adjustable values that map to the 6 preset buttons on the optional mouse controller. You can set each preset to a commonly used beam heading, allowing rapid single button heading selections.

PS85 - Program Simulation

Program Simulation allows the user to set the serial communication protocol used by the rotator. When set to emulate another brand of rotator, the AlfaSpid will respond to commands, and send responses back to the computer as if it were the rotator brand selected. If your favourite software supports a rotator, chances are, the AlfaSpid will be able to interface to your software. There are 4 modes available:

PS85 - Spid (AlfaSpid) Recommended

PS80 - Orion

PS84 - Hygain

PS84 - Yaesu



8880 - Heading Adjust (numbers blinking)

This setting can be used to make minor heading adjustments without causing the rotator to turn. If you notice that the heading displayed on the controller to a known signal source is out by a few degrees, you can change the heading displayed on the LED readout to match the known heading, rather than having to turn back to North and reset the controller.

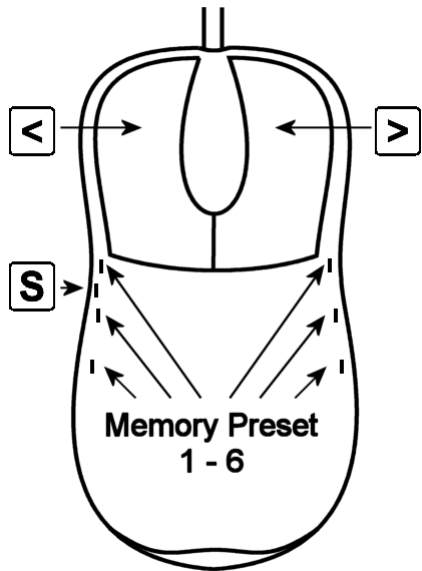
Mouse Controller (Optional)



The optional mouse controller (**not** a computer mouse) allows easy desktop access to the most commonly used front panel controls. These buttons are functionally equivalent to the corresponding front panel controls.

-  - Left (Decrease)
-  - Right (Increase)
-  - Stop (also the wheel between left right buttons)

 The mouse controller is a highly modified computer mouse. You can not use a regular mouse with the AlfaSpid and

In addition to the above controls, you will find 6 programmable preset buttons on the mouse. Programmable preset buttons are only available via the optional mouse controller. Preset headings are programmed via the Setup Mode

The mouse ball serves no function; the mouse simply provides an ergonomically pleasing case in which to mount the controls.

Alfa Radio Ltd. Trouble shooting tips

Before contacting MFJ, Please make the following tests:.

The following are some trouble shouting tips, if for some reason your *AlfaSpid* will not operate correctly.

It is important to confirm correct operation before installing on the tower. This will rule out any damage that may have been caused by the shipping company.

Check the Limits - PH and PL settings and rule out overlap.

Simple resistance tests can reveal incorrect or shorted wiring.

Pins 1 and 2 are the motor winding and will have a low resistance. Typical 2 to 3 ohms.

Pins 3 and 4 are the sense lines and typically will have either an open circuit or have about 1200 ohms depending on the status of the reed switch in the rotator and the length and gauge of used wire.

There should be no conductivity between 1 and 3 or 1 and 4, or between 2 and 3 or 2 and 4

All lines should have **no** conductivity to ground.

Be careful not to over wind your coax with the next test, as there will be no protection from over turning.

Find a small 12 volts supply which will deliver 3 to 4 amps. (a small 12 Volt battery will work just fine)

To confirm that the motor runs you may connect 12 volts D.C. to the lines that go to the motor, pins 1 and 2, it should turn. Reversing the 12 Volts D.C. should cause the motor to turn in the reverse direction.

To confirm that the sense circuit in the rotator is working, connect an ohm meter to the senses lines pins 3 and 4, apply 12 volts to the motor lines pins 1 and 2; you should see the ohm meter reading alternate between open circuit and about 1200 ohms while the motor is turning.

Pin on Rotator not controller	Typical Reading	Your reading	
Pins 1 to 2	About 2 to 4 Ohms	_____	Depends on the length of wire to rotator
Pins 3 to 4	Open or 1200 Ohms	_____	Depends on the status of the read switch
Pins 1 to 3	Open	_____	
Pins 2 to 3	Open	_____	
Pins 2 to 4	Open	_____	
Pin 1 to Ground	Open	_____	
Pin 2 to Ground	Open	_____	
Pin 3 to Ground	Open	_____	
Pin 4 to Ground	Open	_____	
Voltage on controller			
Pins 1 to 2	About 12 volts with motor running		Depends on the supply voltage (14 volt applied)
Pins 3 to 4	About 8.5 volts or 2.5 volts *		Depends on the status of the read switch and the Supply voltage

Using the AlfaSpid Rotator with LONG Cable Distances By VE6JY

Since the motor uses relatively low voltage DC, a combination of long cable runs and/or thinner than required cable may reduce the voltage at the motor to an unacceptably low value. It may turn in warm weather or light winds but the power will not be available to rotate under more severe conditions.

While it is easy to say just use a heavier cable, this may be costly, impractical or both. I have one tower that is over 1700 feet (approx 500 meters away) and running large cable out there would be very expensive.

My solution is to use this rotator controller's output voltage to control another set of relays that will feed a higher voltage DC to the motor. In the above-mentioned example, I find a voltage between 60 to 80 volts gave suitable performance. This is a pretty extreme case but it illustrates the versatility of this design. The external DC supply voltage needed will vary depending on the DC voltage rating of your motor, the cable size and length of the run. Typically 36 to 50 volts at 3-5 amps should be quite adequate. These DC motors are quite tolerant on their voltage ratings.

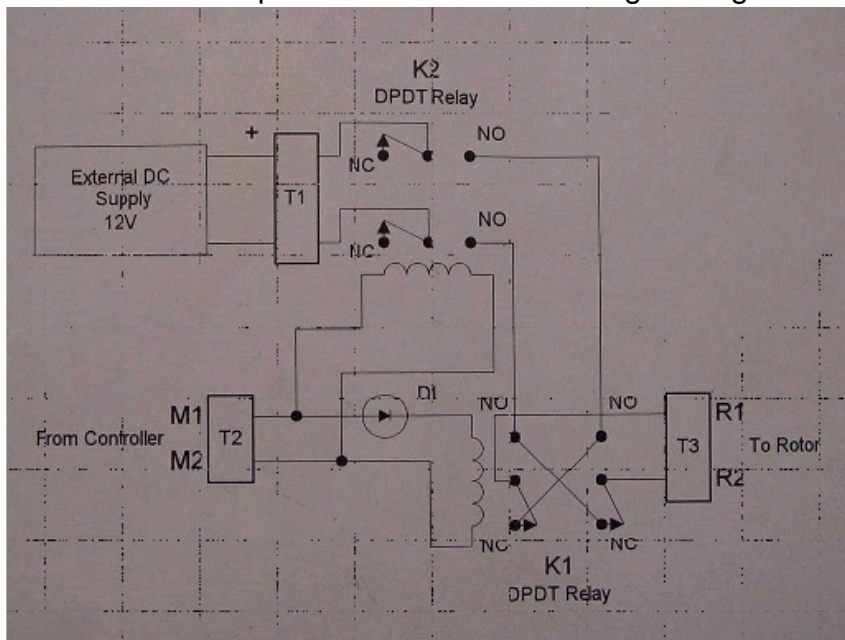

Relay Board Schematic

Relays chosen should be suitable for the proper coil voltage as well as appropriate current carrying capability. A relay capable of 5 to 10 amps DC is adequate. The diode in series with Relay K1 is any general purpose 1 amp style such as the 1N400x series. If the motor rotates incorrectly, simply reverse the leads to the motor or from the External DC Supply.

The controller also has the capability to, with a small modification, allow you to input your external DC voltage into the unit and use the internal relays to control the rotator as usual.



This information is presented as a guide to help the user realize a solution to the long cable run situation.

Prepared for Alfa Radio Ltd. by VE6JY Don Moman Dec 6/2001

12 MONTH LIMITED WARRANTY

hy-gain® LIMITED WARRANTY

hy-gain Warrants to the original owner of this product, if manufactured by **hy-gain** and purchased from an authorized dealer or directly from **hy-gain** to be free from defects in material and workmanship for a period of **12** months for rotator products and **24** months for antenna products from date of purchase provided the following terms of this warranty are satisfied.

1. The purchaser must retain the dated proof-of-purchase (bill of sale, cancelled check, credit card or money order receipt, etc.) describing the product to establish the validity of the warranty claim and submit the original or machine reproduction of such proof-of-purchase to **hy-gain** at the time of warranty service. **hy-gain** shall have the discretion to deny warranty without dated proof-of-purchase. Any evidence of alteration, erasure, or forgery shall be cause to void any and all warranty terms immediately.
2. **hy-gain** agrees to repair or replace at **hy-gain's** option without charge to the original owner any defective product under warranty, provided the product is returned postage prepaid to **hy-gain**.
3. Under no circumstances is **hy-gain** liable for consequential damages to person or property by the use of any **hy-gain** products.
4. Out-of-warranty Service: **hy-gain** will repair any out-of-warranty product provided the unit is shipped prepaid. All repaired units will be shipped COD to the owner. Repair charges will be added to the COD fee unless other arrangements are made.
5. This warranty is given in lieu of any other warranty expressed or implied.
6. **hy-gain** reserves the right to make changes or improvements in design or manufacture without incurring any obligation to install such changes upon any of the products previously manufactured.
7. All **hy-gain** products to be serviced in-warranty or out-of-warranty should be addressed to **hy-gain, 308 Industrial Park Road, Starkville, Mississippi 39759, USA** and must be accompanied by a letter describing the problem in detail along with a copy of your dated proof-of-purchase.
8. This warranty gives you specific rights, and you may also have other rights which vary from state to state.

Contact Hy-Gain for authorization before shipping.

By Telephone:

General Information: (800) 973-6572 (662) 323-9538

Technical Support: (662) 323-9538

Fax Number: (662) 323-5803

By Mail:

Mailing Address: Hy-Gain

308 Industrial Park Road, Starkville, MS 39759, U.S.A.

By E-Mail:

Website Questions: website@hy-gain.com

Manual Requests: manuals@hy-gain.com

Catalog Requests: catalogs@hy-gain.com

Customer Service: hygain@mjenterprises.com

Technical Support: hygain@mjenterprises.com

PayPal Payments: hygainpaypal@mjenterprises.com

NOTE: There is a **two to five day response time** for all technical support emails. If this is not fast enough for you, please call us on our technical support lines listed above.

NOTES:

Typical travel of the AlfaSpid Rotator

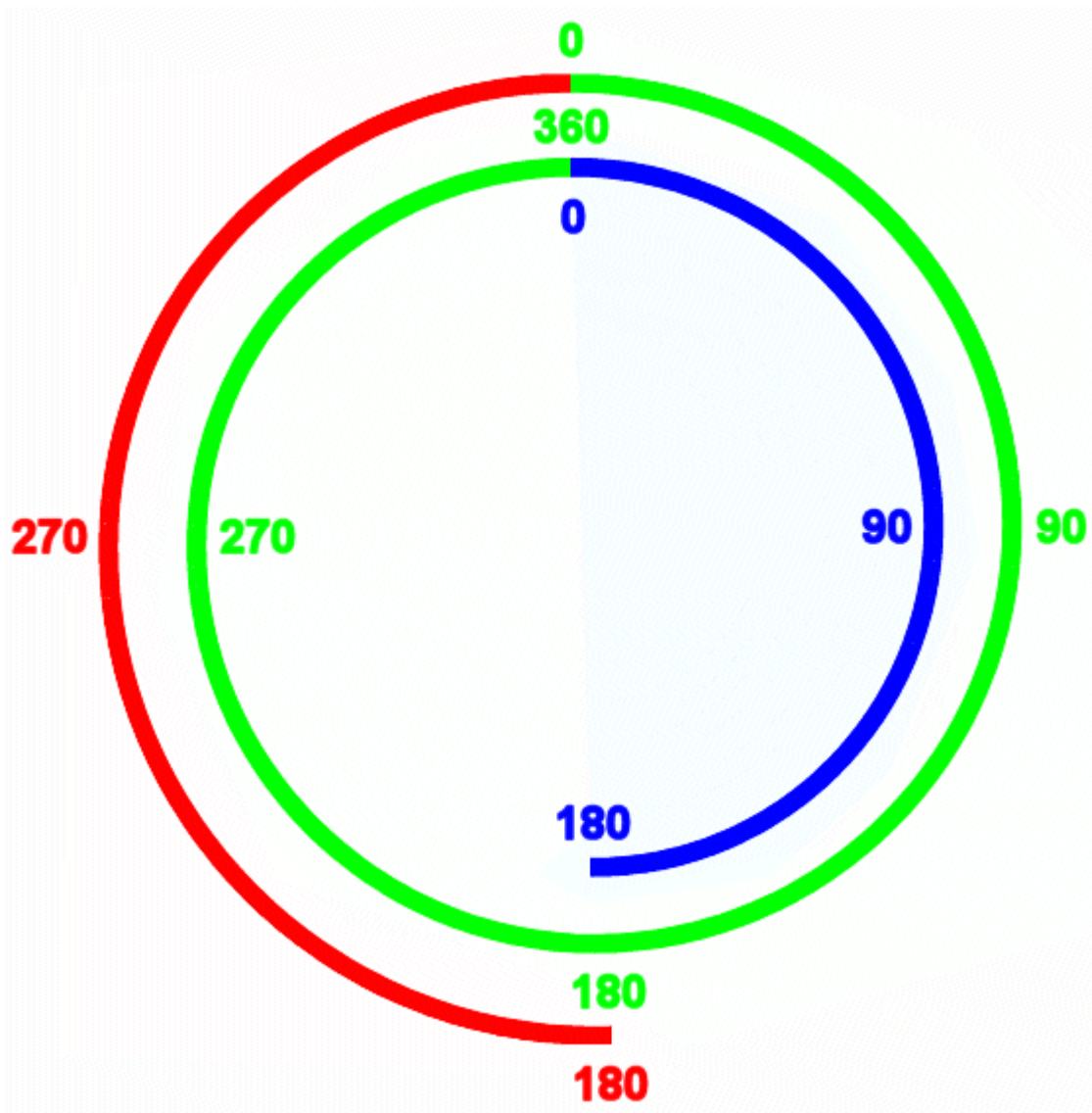

Blue 0 to 180 is the dot (not flashing) PH over travel (Right 180 side of diagram)

Red 0 to 180 is the dot (flashing) PL over travel (Left 180 side of diagram)