

# MFJ

## *MFJ Tunable DSP Filter*

*Model MFJ-784B*



### INSTRUCTION MANUAL

CAUTION: Read All Instructions Before Operating Equipment

## MFJ ENTERPRISES, INC.

300 Industrial Park Road  
Starkville, MS 39759 USA  
Tel: 662-323-5869 Fax: 662-323-6551

# Contents

Before Reading This Manual.....	iv
Fast Start .....	1
<b>Chapter 1 Introduction.....</b>	<b>1-1</b>
Introduction to DSP .....	1-2
Product Overview .....	1-3
Block Diagram.....	1-4
Front Panel Layout.....	1-5
Back Panel Layout.....	1-6
Filter Specifications .....	1-7
Unit Specifications .....	1-8
General Specifications .....	1-8
Input/Output Specifications .....	1-8
<b>Chapter 2 Installation.....</b>	<b>2-1</b>
Back Panel Connections .....	2-2
Basic Connections .....	2-3
Setting Receive Audio Level (Input Level).....	2-4
Increasing Headphone Audio Level.....	2-4
Passing Sidetone .....	2-5
T/R Connection.....	2-5
CW Sidetone Filter .....	2-6
DSP to TNC Connections .....	2-6
<b>Chapter 3 Operation.....</b>	<b>3-1</b>
Initial Operation.....	3-2
CW Operation .....	3-3
SSB (and other voice modes) Operation.....	3-4
Front Panel Description .....	3-6
PWR LED .....	3-6
Input Level LED .....	3-6
AGC Button .....	3-7
Program Button.....	3-7
Memory Button.....	3-8
Filters Switch.....	3-8
Tunable Filters Controls.....	3-9
Manual Notch Button.....	3-10

---

## MFJ-784B Instruction Manual

Auto Notch Button .....	3-11
Noise Reduction Control.....	3-12
Noise Reduction Button.....	3-12
Volume Control.....	3-12
Speaker Button .....	3-12
DSP Button .....	3-13
Power Button .....	3-13

### **Chapter 4 Advanced Features..... 4-1**

Memory Filters .....	4-2
Saving Memory Filters.....	4-2
CW Spotting Tone.....	4-4
Measuring Frequency.....	4-4
Talk.....	4-5
Talk Operation.....	4-5
Jumper Settings .....	4-8
Talk Settings.....	4-8
Auto Notch Aggressiveness .....	4-8
Normal Jumper Settings.....	4-8
Normal Jumper Settings Chart.....	4-9
Setting the CW Sidetone Filter .....	4-10
Pre-set Filters .....	4-11
Factory Filter Defaults .....	4-11
Data Mode Jumper Settings Chart.....	4-12

### **Chapter 5 Filter Description..... 5-1**

LR/HR Filter [1] .....	5-2
Band-stop Filter.....	5-3
BP Filter [2].....	5-4
2BP Filter [3].....	5-5
CW Filter [4].....	5-6
CW Sidetone Filter .....	5-6
SSB Filter [5] .....	5-7
RTTY Filter [6].....	5-7
HF PACKET Filter [7] .....	5-7
AMTOR Filter [8].....	5-8
PACTOR Filter [9].....	5-8
SSTV/FAX/WeFAX Filter [10] .....	5-8
Manual Notch Filter.....	5-9
Automatic Notch Filter .....	5-10
Noise Reduction Filter.....	5-10
Limited Filters.....	5-11

**Appendix A ..... A-1**

- Self-Test .....A-2
- In Case of Difficulty.....A-4
- Technical Assistance.....A-4
- Radio to TNC Cables.....A-5
  - MFJ-784B to PK-232 Connections.....A-5
  - MFJ-784B to PK-88 Connections.....A-5
- Pre-set and Memory Filters Settings Chart.....A-6

---

## MFJ-784B Instruction Manual

### Before Reading This Manual

This manual is divided into two parts. The first part, called Fast Start, is meant for people who need to know nothing except how to minimally install the unit and operate it on CW and SSB. The second part, chapters 1-5, is meant for operators who want or need more information. Detailed description of the unit and its operation are described in these chapters.

The first chapter is an introduction to DSP and the MFJ-784B. The second chapter tells about the back panel and how to install the unit with a radio or TNC. Chapter 3 tells how to operate the unit in CW and SSB and describes the various controls. Advanced Features, chapter 4, tells how to use the special features of the MFJ-784B. The last chapter is a description of the digital filters used in this unit.

The appendix has two important sections, troubleshooting and technical assistance. There is also a self-test for the unit's digital circuitry and controls. Refer to these sections if you should have any problem with your new MFJ-784B.

**Important:** *Please read this section to become familiar with the terms and mechanics used in this manual.*

Whenever the manual text discusses a control, jack, or level adjustment, the name will appear in **Bold**.

Example: Plug a headphone into the **Headphones Out** jack for ...

The **Memory/Normal Filters** button will be referred to simply as the **Memory** button throughout this manual.

Definitions for the abbreviations used in this manual are listed below:

LR	=	Low Reject (Cutoff Frequency)
HR	=	High Reject (Cutoff Frequency)
f1	=	Center or Notch Frequency #1
f2	=	Center or Notch Frequency #2
fc	=	Center Frequency
BW	=	Bandwidth
FIR	=	Finite Impulse Response
IIR	=	Infinite Impulse Response
LMS	=	Least Mean Square
WPM	=	Words Per Minute

Explanation of graphical symbol:



The exclamation point within an equilateral triangle is intended to alert you of conditions that may be damaging to the product or resulting in a risk of electric shock to persons.

# Amplifier

This T/R connection is used to pass sidetone.  
 The amplifier connection and diode are optional.  
 See the text on page 2-5.

RLY

1N4001 Diode  
 or equiv.

# Transceiver

ANTENNA

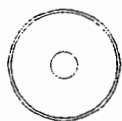

Use a quality RCA cable  
 for the audio connection.

SPEAKER  
 or  
 AUDIO OUT



Gray - Shield  
 Black - Conductor

RLY

T/R (Pin 5)

Ground (Pin 2)

# MFJ-784B DSP Filter

This device complies with part 15 of the FCC Rules. Operation is subject to the following two conditions: (1) This device may not cause harmful interference, and (2) This device must accept any interference received, including interference that may cause undesired operation.

**MFJ ENTERPRISES, INC.**  
**STARBUCKLE, MS USA**

- 1 - TNC XMIT AUDIO
- 2 - GROUND
- 3 - PTT
- 4 - RECEIVE AUDIO IN
- 5 - T/R

- 1 - TNC XMIT AU
- 2 - GROUND
- 3 - PTT
- 4 - RECEIVE AUDIO OUT
- 5 - CONNECTION

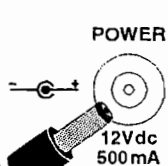

Center Conductor: +12 Vdc

Outside Sleeve: Ground

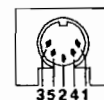
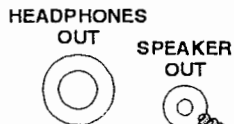

Warning: The MFJ-784B will be damaged by reverse polarity or voltages over 18 volts



# Fast Start

## Beginners' Installation and Operation

To install and use the MFJ-784B in the simplest way possible, follow the steps below. *On some steps we give you a choice of CW or SSB. Choose one throughout this Fast Start section. SSB also works with AM and FM voice.*

1. Install the unit. Follow the installation diagram on the facing page.

2. Set the controls as follows:

Control	Position	Meaning
<b>AGC</b> button:	out	AGC off
<b>Program</b> button:	N/A	N/A
<b>Memory</b> button:	out (normal)	Tunable/Pre-set
<b>Filters</b> switch:	<i>CW or SSB</i>	<i>CW or SSB filter</i>
<b>Tunable Filters</b> left knob:	center	middle center freq.
<b>Manual Notch</b> button:	out	manual notch off
<b>Tunable Filters</b> right knob:	full counter-clockwise	widest bandwidth
<b>Auto Notch</b> button:	out	auto notch off
<b>Noise Reduction</b> control:	full counter-clockwise	minimum reduction
<b>Noise Reduction</b> button:	out	noise reduction off
<b>Volume</b> control:	full counter-clockwise	minimum volume
<b>Speaker</b> button:	in	speaker on
<b>DSP</b> button:	out	DSP bypassed
<b>Power</b> button:	out	MFJ-784B off

3. Apply external power and press and lock the DSP's **Power** button. The **PWR** LED on the front panel should light red. If it is green, press the **Memory** button.

4. Set the input level.

- Tune your radio to a *CW or SSB* station.
- Set your *radio's* volume control to a normal level.
- Use a screwdriver to adjust the **Receive Audio Adjust** (on the back panel of the DSP) until the **Input Level** LED (front panel) flashes mostly green and never red (red is too high, off is too low).



---

## MFJ-784B Fast Start

5. How to operate the CW filter. (If you work SSB skip to step 6)
  - a. Your radio should still be tuned to a CW station and setup as in step 2 (except **Power**). Press and lock the **DSP** button. Adjust the DSP's volume control.
  - b. Press and hold the red **Program** button. You will hear a tone.
  - c. Adjust the left **Tunable Filters** control (center frequency or fc) until the tone is the same pitch as the CW station. When the tones are closely matched, release the **Program** button.
  - d. Slowly adjust the right **Tunable Filters** control (bandwidth or BW) clockwise. The CW station's signal should become clearer (less noise and QRM).
  - e. Practice on other single stations and even with several CW stations sending at the same time. With practice, you will be able to separate mixed signals and copy signals that were undetectable without the filter. Also, experiment with the **Noise Reduction**, **AGC**, and **Manual Notch** controls.
  
6. How to operate the SSB filter. (If you work CW skip to step 7)
  - a. Your radio should still be tuned to a SSB station and setup as in step 2 (except **Power**). Press and lock the **DSP** button. Adjust the DSP's volume control.
  - b. Adjust the right **Tunable Filters** control (bandwidth or BW) clockwise to make the SSB signal clearer (less noise and QRM) while not making the signal less intelligible.
  - c. Adjust the left **Tunable Filters** control (center frequency or fc) to peak the signal for maximum intelligibility.
  - d. Re-adjust the right **Tunable Filters** control (bandwidth or BW) clockwise to eliminate most of the noise and QRM. At some point decreasing the bandwidth will make the signal less intelligible.
  - e. Press the **DSP** button to the "out" position. Find another station that has CW or some other tone interference audible with a SSB or voice signal.
  - f. Press the **DSP** button to the "in" position and filter the voice signal. Lock the **Auto Notch** button "in." Any remaining tones should disappear or be greatly reduced.
  - g. Experiment with different filter adjustments and functions under various conditions to become familiar with the various controls.
  
7. Now that you have used the DSP filter you can read other parts of this manual to learn to use the other features of the MFJ-784B.

---

## Introduction

---

### Contents of This Chapter

▶ Introduction to DSP	Page 1-2
▶ Product Overview	Page 1-3
▶ Block Diagram	Page 1-4
▶ Front Panel Layout	Page 1-5
▶ Back Panel Layout	Page 1-6
▶ Filter Specifications	Page 1-7
▶ Unit Specifications	Page 1-8
General Specifications	Page 1-8
Input/Output Specifications	Page 1-8

---

## **MFJ-784B Instruction Manual**

### **Introduction to DSP**

The MFJ-784B *tunable* DSP Filter™ uses state-of-the-art Digital Signal Processing (DSP) technology. Digital Signal Processing greatly improves signal clarity by reducing or eliminating noise (QRN) and interference (QRM). DSP technology has existed for many years but has always been very complicated and expensive. Recent advances in integrated circuits have greatly increased the processing power and reduced the size of DSP units. These same advances also lowered the cost of DSP filtering, making DSP technology affordable for the average amateur or short wave listener.

The heart of any DSP system is the digital signal processor. Almost any microprocessor can perform DSP, such as the one in a personal computer, but only very fast or special-function processors perform DSP in *real time*. A digital signal processor's commands are tailored to the type of instructions used in signal processing. The use of special DSP commands allows a DSP filter function to be completed in very few clock cycles (usually one). The CPU in a typical personal computer would require a long set of instructions and therefore many clock cycles to perform the same function. Analog Device's 16-bit 12 MHz processor, the ADSP-2105, is used in the MFJ-784B.

The MFJ-784B DSP Filter converts the analog audio signals from your receiver to digital information. This conversion is achieved by sampling the audio signal many thousands of times per second with an analog-to-digital converter. The result is a string of digital "numbers" that represent the amplitude and frequency of the analog input signal. The ADSP-2105 chip then processes the digital information with different digital filter algorithms depending on the settings of the front panel controls. The end result is a digitized signal with undesired signal components either reduced or removed and desired components enhanced. The processed digital signal information is converted back to an audio signal by a digital-to-analog converter and sent to the audio amplifier and line level outputs.

### Product Overview

The MFJ-784B tunable DSP filter is a highly selective audio filter suitable for most amateur applications. The MFJ-784B contains 5 tunable filters, 5 pre-set filters, a tunable manual notch, an automatic notch filter, and an adaptive noise reduction filter. Filter settings can be saved into one of ten memory filter positions.

The 5 tunable filters consist of the following:

LR/HR	Low Reject/High Reject
BP	Band-pass
2BP	Double band-pass
CW	CW mode band-pass
SSB	SSB mode band-pass

The 5 pre-set data filters are band-pass filters programmed with jumpers for the different data modes mark-space frequencies and baud rates:

RTTY  
HF PACKET  
AMTOR  
PACTOR  
SSTV/FAX/WeFAX

The tunable manual notch filter attenuates 2 tones manually with the front panel controls.

The auto notch filter attenuates up to 4 tones automatically. The automatic notch will attenuate moving or shifting tones. The automatic notch is disabled in the following modes: CW, RTTY, HF PACKET, AMTOR, PACTOR, and SSTV/FAX/WeFAX.

The noise reduction filter uses adaptive and manually adjustable algorithms to provide up to 20 dB noise reduction. The amount of noise reduction is adjustable with a front panel control.

Block Diagram

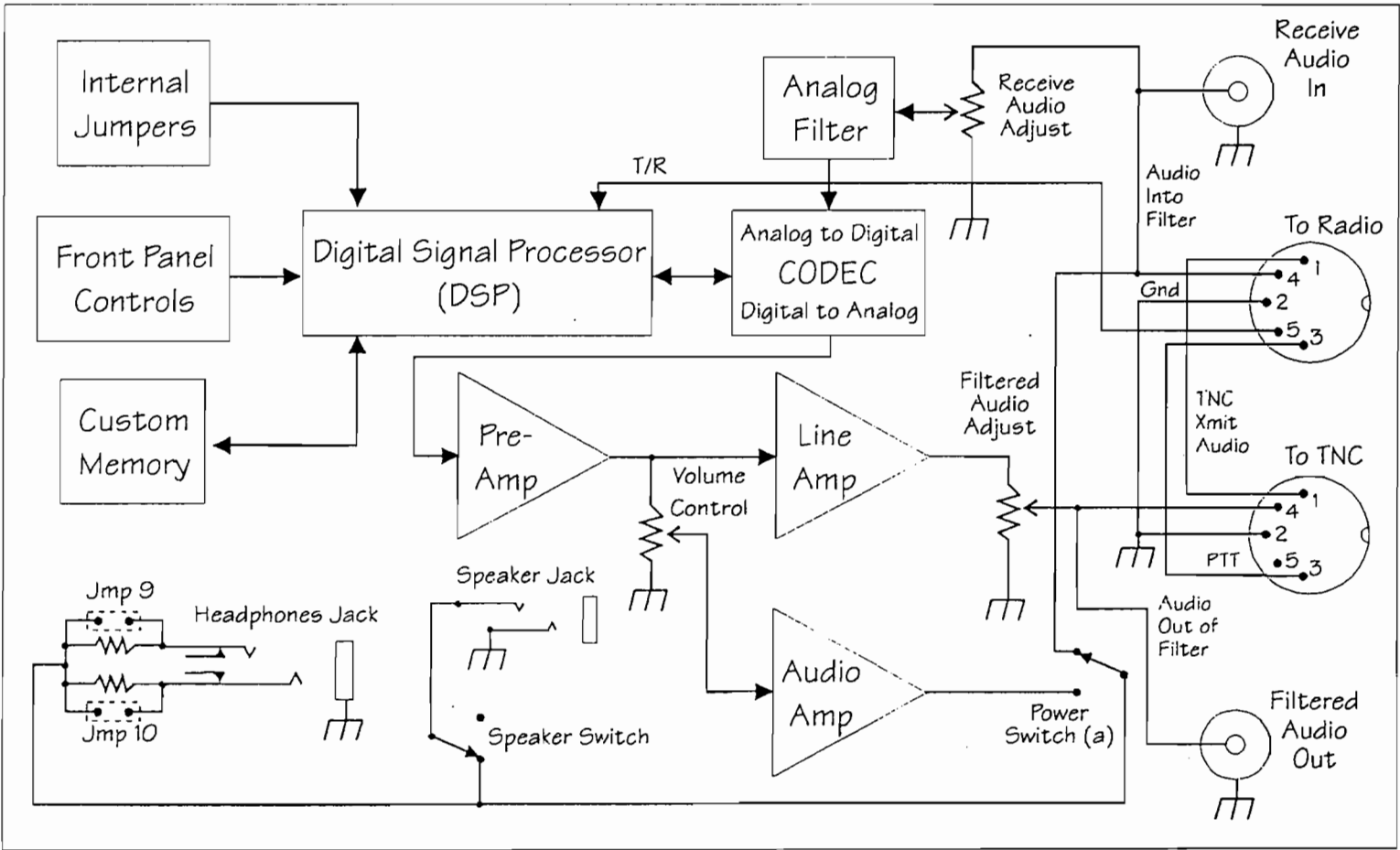

Front Panel Layout

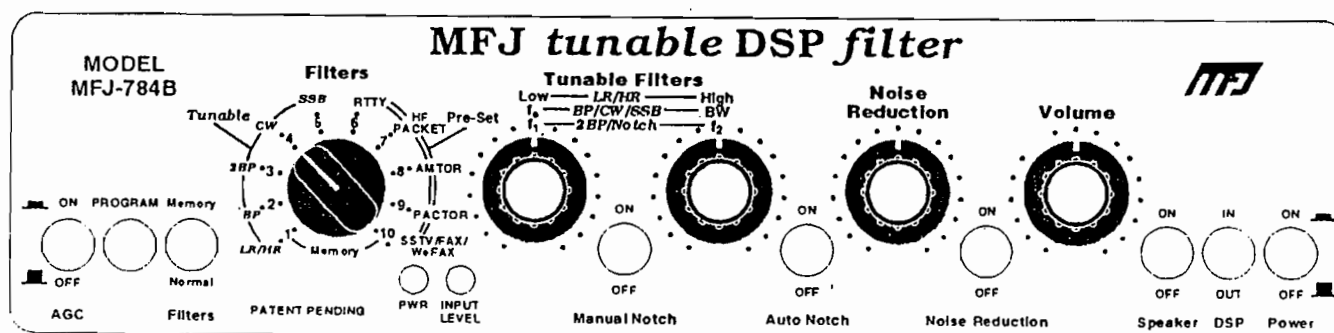

- AGC** button: Press to enable the automatic gain control; press again to turn it off.
- Program** button: Press to program memory filters, to talk, or to activate CW spotting tone.
- Memory** button: Selects either normal or memory filters mode.
- Filters** switch: Selects one of ten normal or ten memory filters.
- PWR** LED: Indicates normal (red) or memory (green) mode.
- Input Level** LED: Indicates input signal level (red too high, off too low, green is OK).
- Tunable Filters** left knob: Adjusts tunable filters and manual notch.
- Manual Notch** button: Press to enable the manual notch; press again to turn it off.
- Tunable Filters** right knob: Adjusts tunable filters and manual notch.
- Auto Notch** button: Press to enable the automatic notch; press again to turn it off.
- Noise Reduction** knob: Controls the level of noise attenuation.
- Noise Reduction** button: Press to enable the noise reduction; press again to turn it off.
- Volume** control: Controls the output volume level to speaker and headphones jacks.
- Speaker** button: Press to enable the speaker jack; press again to turn it off.
- DSP** button: Press to turn on digital processing of input signal; press again to bypass processing.
- Power** button: Press to turn the power on; press again to turn the power off.

For an in-depth description of the front panel controls, refer to chapter 3, Operation.

# MFJ-784B Instruction Manual

## Back Panel Layout

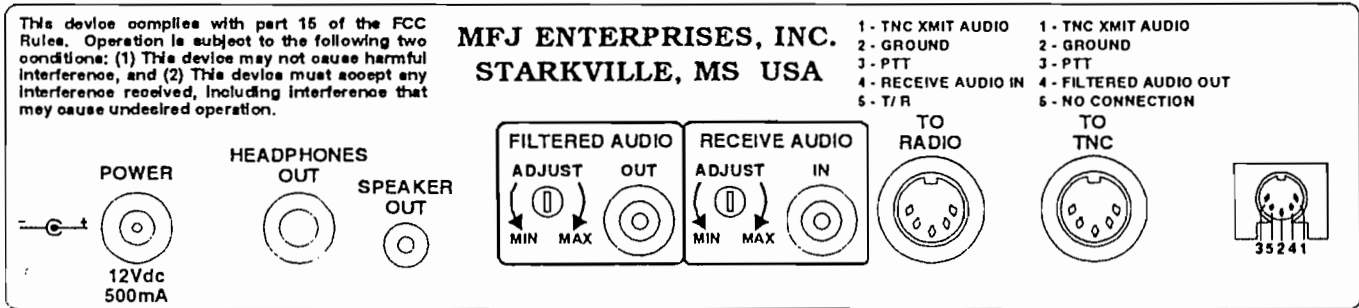

- Power:** 10-16 Vdc @ .5 amp peak (low "Z " audio load)
- Headphones Out:** 1/4" stereo or mono phone jack
- Speaker Out:** 3.5 mm stereo or mono phone jack
- Filtered Audio Adjust:** screwdriver adjustable potentiometer
- Filtered Audio Out:** RCA phono jack (~1.5 V P-P @ 600 ohms)
- Receive Audio Adjust:** screwdriver adjustable potentiometer
- Receive Audio In:** RCA phono jack
- To Radio:** 5-pin DIN jack  
(TNC xmit audio, ground, PTT, receive audio in, T/R)
- To TNC:** 5-pin DIN jack  
(TNC xmit audio, ground, PTT, filtered audio out)

For an in-depth description of the back panel connections, refer to chapter 2, Installation.

**Filter Specifications**

Filter	Left Control	Right Control	Attenuation <sup>7</sup>	Type
LR/HR <sup>1</sup>	LR: 200-2200 Hz	HR: 1400-3400 Hz	57 dB @ 75 Hz	FIR
BP	fc: 300-3400 Hz	BW: 30-2100 Hz	47 dB @ 60 Hz	FIR
2BP <sup>2</sup>	f1: 300-3400 Hz	f2: 300-3400 Hz	47 dB @ 60 Hz	FIR
CW <sup>3</sup>	fc: 300-1000 Hz	BW: 30- 700 Hz	47 dB @ 60 Hz	FIR
SSB <sup>4</sup>	fc: 600-1700 Hz	BW:1000-2500 Hz	57 dB @ 75 Hz	FIR
RTTY	Jumper Programmable		47 dB @ 60 Hz	FIR
HF PACKET	Jumper Programmable		47 dB @ 60 Hz	FIR
AMTOR	Jumper Programmable		47 dB @ 60 Hz	FIR
PACTOR	Jumper Programmable		47 dB @ 60 Hz	FIR
SSTV/FAX/WeFAX	Fixed @1050-1350 Hz and 1450-2350 Hz		45 dB @ 60 Hz	FIR
Manual Notch	f1: 150-3400 Hz	f2: 150-3400 Hz	40 dB @ 95 Hz	IIR
Manual Notch (CW mode)	f1: 300-1000 Hz	f2: 300-1000 Hz	40 dB @ 105 Hz	IIR
Multiple Automatic Notch <sup>5</sup>	Entire freq. range of the received audio		Up to 50 dB	LMS
Random Noise Reduction <sup>6</sup>	Entire freq. range of selected band-pass filter		Up to 20 dB	LMS

Notes

- 1 The **LR/HR** filter becomes a band-stop filter when **LR** is adjusted higher than **HR**.
- 2 The **2BP** filter uses the bandwidth setting last used in **BP** filter but allows independent variation of the two center frequencies.
- 3 The **CW** filter has an optional jumper-programmable sidetone filter.
- 4 The **SSB** filter has its lower cutoff frequency limited to 175 Hz.
- 5 The multiple automatic notch has four levels of aggressiveness.
- 6 The random noise reduction has a variable level of noise reduction.
- 7 All FIR and IIR filter attenuation is indicated in dB @ a distance in Hz outside the passband. All LMS filter attenuation is dependent on the characteristics of the noise.

- All FIR filters are linear phase with a 23 mS time delay and have the upper cutoff frequency limited to 3900 Hz.

FIR - Finite Impulse Response    IIR - Infinite Impulse Response    LMS - Least Mean Square



---

## MFJ-784B Instruction Manual

### Unit Specifications

#### **General Specifications**

Processor: Analog Devices ADSP-2105. Data width - 16 bits. Clock speed - 12 MHz.

Bypass: The MFJ-784B DSP filter has a direct audio bypass when power switch is in "off" position.

#### **Input/Output Specifications**

Power: The maximum current demand will be less than 500 mA at maximum volume but will always be more than 175 mA.

Filtered Audio Out: This jack provides approximately 1.5 volts P-P into 600 ohm (or higher) impedance loads (160 mW @ 6 ohms). The output voltage of this jack is dependent on **Filtered Audio Adjust**.

Receive Audio In: This jack should be driven in a range of 1 to 2.8 volts P-P when **Receive Audio Adjust** is set to maximum sensitivity. When **Receive Audio Adjust** is set to minimum sensitivity, the DSP requires a very high input voltage. Input circuit loading is 10 K ohms nominal.

Audio Output: Audio output power is  $\approx$ 2.5 watts into a 6 ohm load with the MFJ-1315 power supply. Audio frequency response is from 250 to 3100 Hz (-3 dB).

## Installation

---

### Contents of This Chapter

- ▶ Back Panel Connections Page 2-2
- ▶ Basic Connections Page 2-3
  - Setting Receive Audio Level (Input Level) Page 2-4
  - Increasing Headphone Audio Level Page 2-4
- ▶ Passing Sidetone Page 2-5
  - T/R Connection Page 2-5
  - CW Sidetone Filter Page 2-6
- ▶ DSP to TNC Connections Page 2-6

---

## MFJ-784B Instruction Manual

### Back Panel Connections

Power: This connector supplies power to the unit. It connects to a 2.1 mm coaxial plug with the center conductor positive and the shield ground. An optional dc supply, the MFJ-1315, is available from MFJ. The voltage should be 10-16 Vdc. ***If the power supply voltage drops below 10 volts the MFJ-784B will perform erratically.***



***Warning:*** Voltages greater than 18 volts or reverse polarity may permanently damage the MFJ-784B.

Headphones Out: This jack supplies volume controlled audio for headphones. It accepts standard male 1/4 inch stereo or mono phone plugs and provides audio to both stereo and mono headphones.

Speaker Out: This jack supplies volume controlled audio for a speaker or walkman type headphones with 3.5 mm stereo or mono phone plugs. Disengaging the **Speaker** button disables this jack.

Filtered Audio Adjust: This adjustment varies the level of the audio outputs to **Filtered Audio Out** and pin 4 of the **To TNC** port.

Filtered Audio Out: This jack supplies line level audio for tape recorders or audio amps. It is a standard RCA phono jack. A quality shielded cable should be used for connections to this jack. The output is dependent on the **Filtered Audio Adjust** and independent of the DSP's volume control.

Receive Audio Adjust: This adjustment controls the sensitivity of the **Receive Audio In** jack and pin 4 of the **To Radio** port. Proper adjustment is achieved if the **Input Level** indicator flashes mostly green and never red when the receiver's volume is at normal levels. Refer to page 2-4.

Receive Audio In: This jack is normally connected to the receiver's speaker or headphones output. It is a standard RCA phono jack. A shielded cable should be used to connect this connector to the station receiver.

To Radio: This port supplies connections for transmit and receive audio. PTT is connected directly to the **To TNC** port. A connection is also available for a **T/R** line to automatically bypass the filter during transmit.

To TNC: This port supplies connections to the filtered audio output and the transmit audio inputs. PTT is connected directly to the **To Radio** port.

# MFJ-784B Instruction Manual

## Basic Connections

In the most simple case, the MFJ-784B will be installed in the audio path between your receiver and your headphones or speaker.

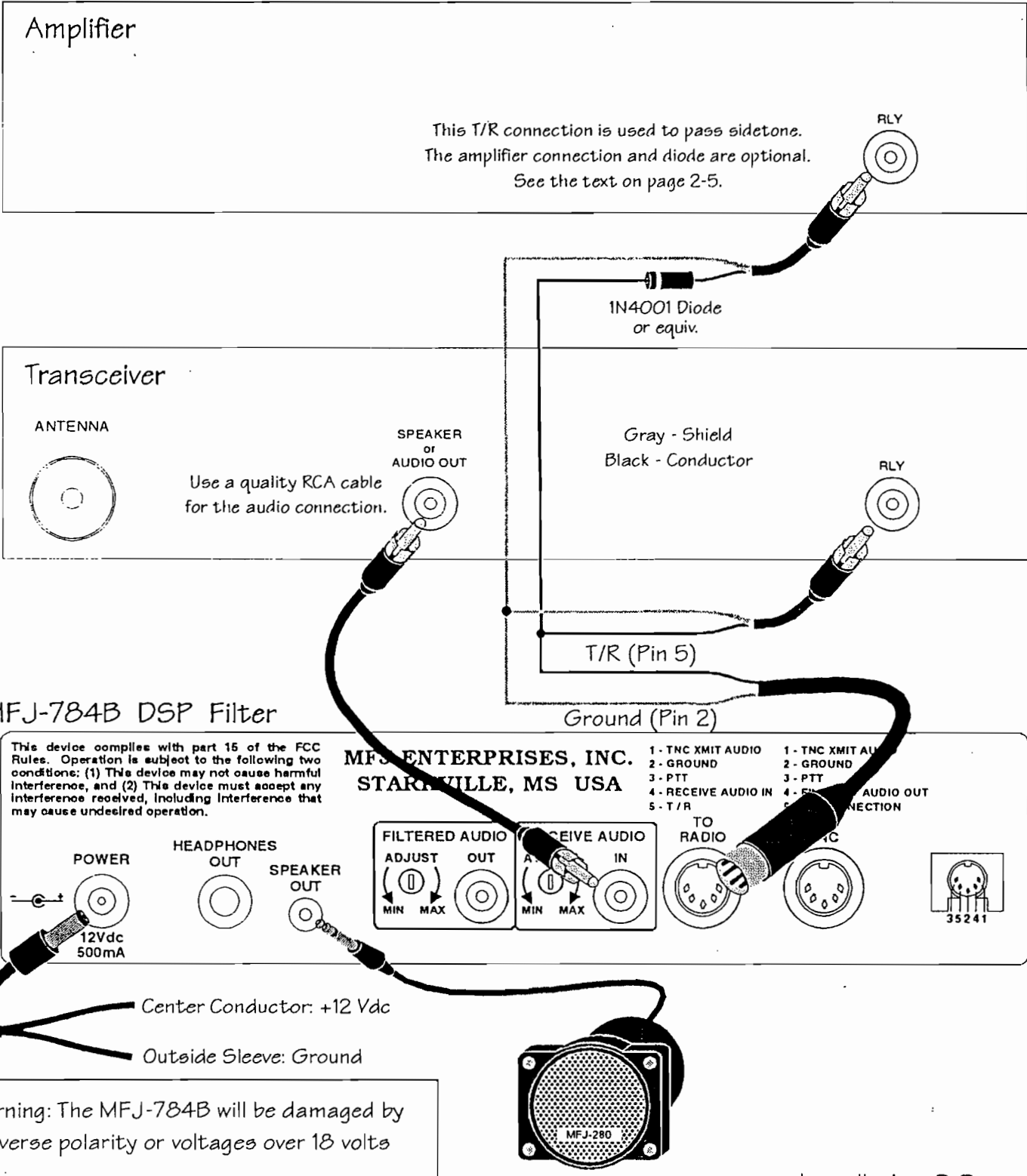

---

## MFJ-784B Instruction Manual

### Setting Receive Audio Level (Input Level)

When first connecting the DSP filter and whenever the receiver audio level changes, you should check the **Input Level** indicator. This LED indicates the input signal level. As a signal is received, the **Input Level** LED will flash from "off" to either green or red.

If the indicator flashes:

<b>Mostly Green</b> (never red)	the input level is adjusted correctly.
<b>Any Red</b>	the input level is too high.
<b>Stays Off</b> (or barely green)	the input level is too low.

To set **Receive Audio Adjust**:

1. Tune your radio to the type of signal you will be operating most.
2. Set your *radio's* volume control to a normal level.
3. Use a screwdriver to adjust the **Receive Audio Adjust** (on the back panel of the DSP) until the **Input Level** LED (on the front panel) flashes mostly green and never red.

**Note:** *Some compromise may be required if the receiver does not maintain the same audio level on different modes. Set the **Receive Audio Adjust** on the DSP for the most common mode, and use the receiver's volume knob to properly adjust the level when switching modes.*

### Increasing Headphone Audio Level

The MFJ-784B headphone level is attenuated as it comes from the factory. If a speaker is at a comfortable level and the headphones are too quiet, the level may be raised by using jumpers JMP 9 and JMP 10 (next to the headphones jack).



**Warning:** *Do not short JMP 10 when using a mono phone plug or damage to your unit will result.*

To raise the headphone audio level for mono headphones, put a 470 ohm or smaller resistor on JMP 9. For stereo headphones, put **another** 470 ohm or smaller resistor on JMP 10.

## **Passing Sidetone**

Operators may listen to a station tone with different pitch than the sidetone of their transmitter. In this situation, the DSP filter will attenuate the sidetone and the operator will not be able to monitor his sending. There are two methods of passing sidetone through the DSP filter.

### **T/R Connection**

The *preferred* method for passing sidetone is the use of the **T/R** (transmit/receive) line on the DSP's **To Radio** port. All filter functions are bypassed when the **T/R** line is pulled low. The transceiver's sidetone and audio monitoring functions will appear at the DSP output without digital filtering.

The **T/R** line should be connected to an output from your radio that is pulled low when the radio goes into the transmit mode (such as an output for an external RF amplifier). Radio manufacturers call such a line many different names: Relay or RLY; NO or normally open; xmit, transmit or send; or maybe even PTT.

If a linear amplifier is connected to the **T/R** line, a diode (1N4001 or equivalent) should be connected from the linear amplifier's control (relay) jack to the **T/R** line. This diode prevents the amplifier from loading the DSP's **T/R** line when the amplifier is turned "off." The anode of the diode should be connected to the amplifier and the cathode (banded end) to the **T/R** line.



**WARNING:** *Never connect the **T/R** line to negative voltages or to positive voltage sources that exceed 35 volts.*

The DSP has internal protection circuitry to help prevent other equipment connected to the **T/R** line (such as a linear amplifier) from damaging the unit.

## MFJ-784B Instruction Manual

### CW Sidetone Filter

The *less preferred* method for passing sidetone involves programming a special internal CW sidetone filter. The CW sidetone filter is a totally separate, jumper programmed, constant frequency filter. This option makes the DSP function with two separate parallel filters. One filter is the standard adjustable CW filter and the other is the fixed frequency CW sidetone filter. This method has the advantage of not requiring a T/R connection, but the disadvantage of allowing unwanted signals to feed through if they happen to be within 30 Hz of the sidetone frequency. To enable the CW sidetone filter, internal jumpers must be set to the sidetone frequency of your radio. Refer to page 4-10 for a description of setting the sidetone filter. The center frequency of the sidetone filter ranges from 300 Hz to 1000 Hz in 50 Hz increments. The bandwidth of the sidetone filter is fixed at 50 Hz.

### DSP to TNC Connections

When connecting to a TNC, MFJ suggests the use of the 5-pin ports. TNCs need a PTT connection that is only available on these ports.

The MFJ-784B plugs directly into any MFJ/TAPR2 compatible TNC. Use a 5-pin DIN-to-5-pin DIN cable, MFJ-5100, for connection to MFJ/TAPR2 compatible TNCs or the PK-12/96/900. MFJ offers pre-made radio cables (models MFJ-50xx) for connection to your radio and pre-made TNC cables (models MFJ-51xx) for connection to other TNCs. For the PK-88 order model MFJ-5100Z and for the PK-232 order model MFJ-5100X. Refer to the appendix if you wish to make cables for these TNCs.

Pin	To Radio Function	To TNC Function
1	TNC Xmit Audio	TNC Xmit Audio
2	Ground	Ground
3	PTT	PTT
4	Receive Audio In	Filtered Audio Out
5	T/R	No Connection



# MFJ-784B Instruction Manual

## Transceiver

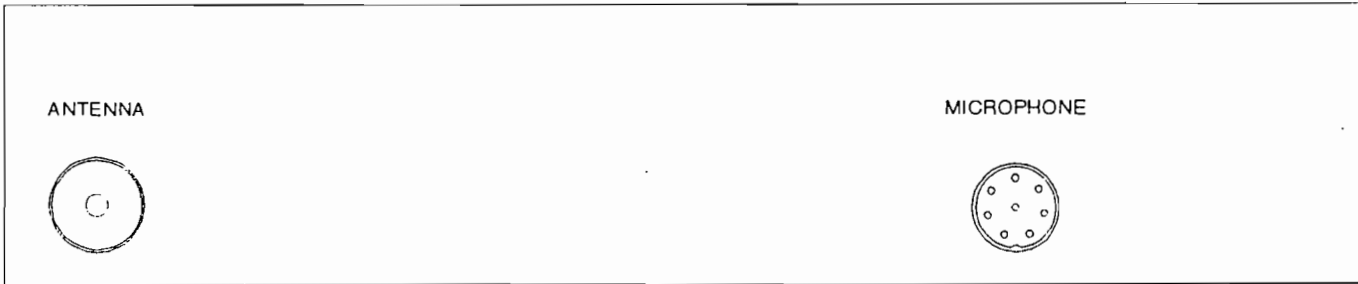

Use a MFJ-50xx series pre-made Radio to TNC cable to connect your radio.

## MFJ-784B DSP Filter

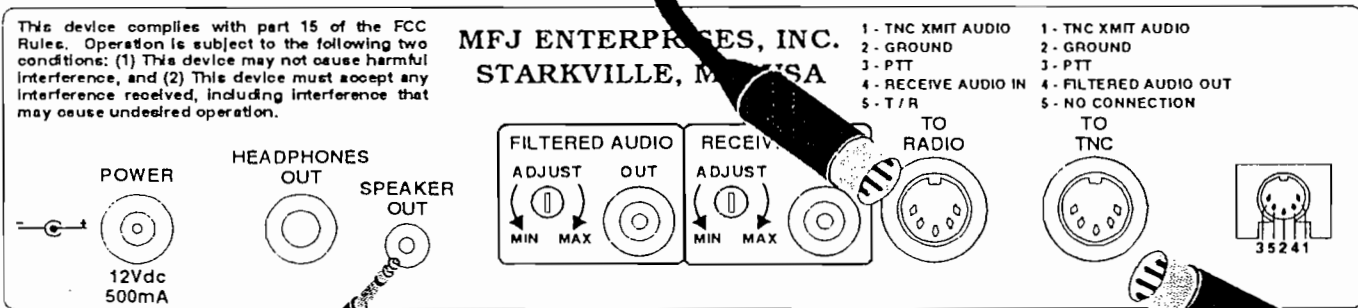

## MFJ TNC

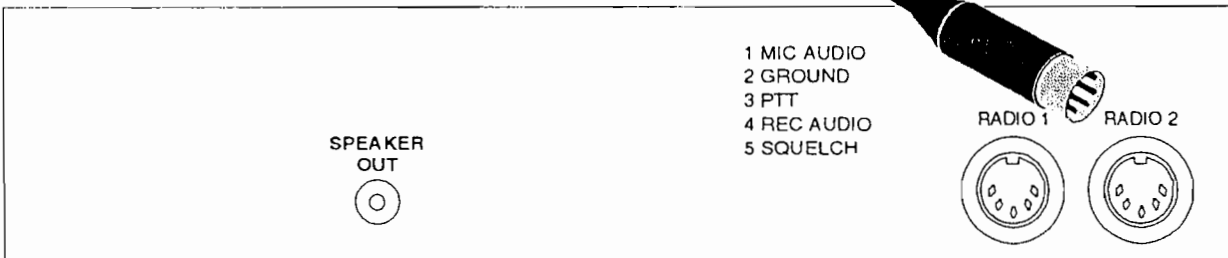



---

## **Operation**

---

### Contents of This Chapter

▶ Initial Operation	Page 3-2
CW Operation	Page 3-3
SSB (and other voice modes) Operation	Page 3-4
▶ Front Panel Description	Page 3-6
Power LED	Page 3-6
Input Level LED	Page 3-6
AGC Button	Page 3-7
Program Button	Page 3-7
Memory Button	Page 3-8
Filters Switch	Page 3-8
Tunable Filters Controls	Page 3-9
Manual Notch Button	Page 3-10
Auto Notch Button	Page 3-11
Noise Reduction Control	Page 3-12
Noise Reduction Button	Page 3-12
Volume Control	Page 3-12
Speaker Button	Page 3-12
DSP Button	Page 3-13
Power Button	Page 3-13

---

## MFJ-784B Instruction Manual

### Initial Operation

Connect the MFJ-784B as outlined in chapter 2. To prepare the unit, set the controls as follows:

<b>Control</b>	<b>Position</b>	<b>Meaning</b>
<b>AGC</b> button:	out	AGC off
<b>Program</b> button:	N/A	N/A
<b>Memory</b> button:	out {normal}	Tunable/Pre-set mode
<b>Filters</b> switch:	CW	CW filter
<b>Tunable Filters</b> left knob:	center	middle center freq.
<b>Manual Notch</b> button:	out	manual notch off
<b>Tunable Filters</b> right knob:	full counter-clockwise	maximum bandwidth
<b>Auto Notch</b> button:	out	auto notch off
<b>Noise Reduction</b> control:	full counter-clockwise	minimum reduction
<b>Noise Reduction</b> button:	out	noise reduction off
<b>Volume</b> control:	full counter-clockwise	minimum volume
<b>Speaker</b> button:	in	speaker on
<b>DSP</b> button:	out	DSP bypassed
<b>Power</b> button:	out	MFJ-784B off



**Warning:** *Damage or improper operation may occur if the polarity, current or voltage of the supply is incorrect. See the installation section on page 2-2. Please don't assume your power supply wiring is correct.*

The external power supply should be connected and on. The headphones and/or speaker should be connected to the correct jacks.

Turn the power on by pressing the DSP's **Power** button. The **PWR** LED will glow *red*. The red glow indicates the normal filter mode is selected and the microprocessor is operating. This LED will glow *green* if the memory filters are selected. Press and release the **Memory** button if this LED is green.

## **CW Operation**

This example will demonstrate how the CW filter operates and show you how to adjust the audio level from the station's receiver for proper DSP operation. If your receiver doesn't operate CW you can skip to the SSB section. That section works for AM, FM, and SSB.

Before attempting to operate your MFJ-784B, you must familiarize yourself with the DSP controls (be sure you have read the preceding sections). Your MFJ-784B should be set up as outlined in the initial operation section on the preceding page. Tune in a CW station and adjust your receiver for normal comfortable levels of pitch and volume.

Next, push and lock the **DSP** button "in." Adjust the DSP's **Volume** control to a comfortable setting. Make sure the left **Tunable Filters** control is centered, and the right control is fully counter-clockwise.

**Note:** *Always use the DSP's volume control to adjust the volume when the DSP is "on." Never adjust the receiver's volume knob to control the volume unless the DSP's power is "off."*

1. Look at the **Input Level** LED. If it flashes or lights red, you will have to decrease the receiver's volume control or adjust the **Receive Audio Adjust** control on the DSP's back panel towards MIN. If the **Input Level** LED is flashing or steadily green the audio level is acceptable. The ideal setting is where the LED is as green as possible without ever turning red. (Refer to page 2-4 for a longer explanation.)
2. Press and hold the red **Program** button. You will hear a tone. Adjust the left **Tunable Filters** control (center frequency or fc) until the tone is the same pitch as the CW station. When the tones are closely matched, release the button.
3. Slowly adjust the right **Tunable Filters** control (bandwidth or BW) clockwise. This will increase the selectivity. The desired signal should become clearer (less noise and QRM) as the right control is moved clockwise. If turning this control makes the desired signal disappear, the left **Tunable Filters** control (fc) will have to be re-adjusted.

*Please go through steps 2 and 3 several times to get a feel for how the controls act. You will notice tuning becomes more touchy as the BW (bandwidth) control is decreased, but the signal becomes clearer. With a little practice you will become very good at adjusting the filter.*

---

## MFJ-784B Instruction Manual

4. Place the **DSP** button in the "out" position. Tune your receiver until a frequency is found with several CW signals sending at the same time. When the digital processing is activated by pressing the **DSP** button "in," you should be able to separate the signals with the **Tunable Filters** controls. Careful adjustments to the DSP filter's center frequency (with moderate or low bandwidth) may even allow you to copy signals that were undetectable without the filter.
5. Take some time to experiment with the **Noise Reduction, AGC, Manual Notch**, and the **Tunable Filters** controls in the CW mode. For the best use of this filter, you should become familiar with the effects of all these controls.

**Note:** *Most people monitor their sending with a transmitter sidetone oscillator. If you use this common method of monitoring yourself, you have to program a sidetone filter or ground the T/R line to monitor yourself. Page 2-5 gives details on this requirement.*

### SSB (and other voice modes) Operation

The example in this section demonstrates the basic SSB filter functions, and allows for further confirmation of the station receiver audio level adjustments. Turn the DSP's **Filters** switch to SSB mode and place the **AGC** and **NOISE REDUCTION** buttons out ("off"). Place the **DSP** button in the "out" position.

Tune in a SSB, AM or FM station and adjust your radio for normal pitch and volume. Press and lock the **DSP** button "in." Adjust the **Volume** control on the DSP to a comfortable volume setting.

**Note:** *Always use the DSP's volume control to adjust the volume when the DSP is "on" unless specifically told otherwise.*

1. Observe the **Input Level** LED and adjust audio input if the LED is not fully green without ever flashing red. The ideal adjustment point is when the LED is as green as possible without ever flashing red. If the LED is red, reduce the receiver's volume control; if the LED is not lit, increase the receiver's volume control. [Refer to page 2-4.]
2. Adjust the left **Tunable Filters** control (center frequency or fc) and the right **Tunable Filters** control (bandwidth or BW) to peak the SSB signal for maximum intelligibility.

3. You should notice the signal becomes clearer (less noise and QRM) as the bandwidth (right **Tunable Filters** control) is moved clockwise and the center frequency (left **Tunable Filters** control) is re-adjusted. At some point decreasing the bandwidth will make the signal less intelligible. If this happens turn the right **Tunable Filters** control counter-clockwise.
4. Place the **DSP** button in the "out" position. Adjust the receiver until you find a frequency that has CW or any other tone interference audible with a SSB or voice signal.
5. Place the **DSP** button in the "in" position. Lock the **Auto Notch** button "in." The interference should disappear or be greatly reduced.

**Note:** *The automatic notch will not recognize signals that vary rapidly in frequency or amplitude, because the filter must ignore rapid amplitude and frequency changes to avoid nulling or distorting voices. If the automatic notch distorts voice reduce the radio volume slightly or select a less aggressive internal auto notch jumper.*

6. Experiment with different filter adjustments and functions under various conditions to become familiar with the various controls.

# MFJ-784B Instruction Manual

## Front Panel Description

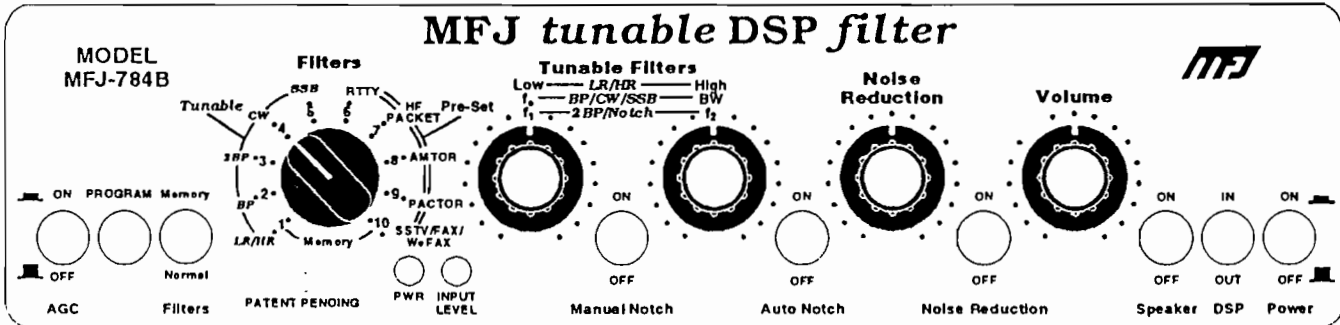

The following section will help you become familiar with the operation of the DSP. The two LEDs are explained first. The buttons, switch, and controls are then explained from left to right as they appear on the panel.

### PWR LED

This LED lights two different colors, red and green. It helps tell you when the DSP is on and working, and whether the DSP is using the memory or the normal Tunable/Pre-set filters.

When you turn the DSP power on, there will be a slight delay and this LED will light. If this LED lights **red**, the Tunable/Pre-set filters are being used.

If this LED is **green**, the memory filters (called **Memory**) that you can store or program are being used. We explain this in detail as we talk about operating the DSP.

If this LED does not light, or does not change color when the **Memory** button is changed, the DSP is not operating correctly.

### Input Level LED

This LED lights two different colors, red and green. It tells you if the DSP is getting the correct audio level from the receiver.

The volume of the audio from your receiver will change with different signals. Please remember that sometimes there may be a lot of receiver audio, and sometimes there may not. For example, the station you are listening to will probably not be sending all the time, or may be fading in and out.

The use of this LED is very simple. When you are listening to a loud signal, adjust the receiver's volume control so the LED lights the most steady and brightest green possible without ever going red. If the LED doesn't light green on good signals, the receiver volume is too low for the best filter performance. With a properly designed receiver that has a good AGC circuit, you won't have to adjust the receiver volume control very often. You will only have to adjust it when (or if) the **Input Level** LED indicates improper level by flashing red or failing to light an almost steady green color.

### **AGC Button**

This button controls an automatic gain control (AGC) program. The AGC program automatically adjusts the DSP's internal gain. It tries to make all signals have exactly the same volume. The AGC button setting cannot be stored in memory. It operates independently of all other buttons and controls except the **DSP** and the **Power** buttons.

The AGC is activated by pushing and locking this button "in." If the DSP is on and operating, pushing the **AGC** button "in" will make every signal have nearly the same volume level, if the input signal level changes less than 18 dB.

If there is a lot of noise on the signal, you may not want to use the AGC function. It will increase the volume of the noise during long pauses in the signal you are listening to. That can distract you or make it difficult to concentrate on the signal you are listening to.

### **Program Button**

This button is used to make the DSP memorize the filter settings you are currently using. When using the tunable CW filter, this button activates the CW spotting tone. It also starts a "Talk" feature if the **DSP** button is "out." This button does not stay locked-in like the other buttons, it springs right back out when released.

The use of this button is very special. To use this button to memorize or save a filter, please read the section on page 4-2. To use this button to activate the spotting tone, please read the section on page 4-4. To use this button to start the Talk feature, please read the section on page 4-5.

---

## MFJ-784B Instruction Manual

### Memory Button

This button allows you to choose two different groups of filters with the **Filters** switch. This button functions any time the DSP's power is on and the **DSP** button is "in."

With the **Memory** button "out," the **Filters** switch picks one of ten Tunable (front panel adjustable) and Pre-set (jumper or factory programmed) filters marked LR/HR through SSTV/FAX/WeFAX.

When the **Memory** button is "in," the **Filters** switch picks a memory location labeled 1 through 10 on the front panel. The DSP processes the signal using the filter you have stored in that memory location. Page 4-2 gives you more detail on the use of memory.

### Filters Switch

This switch picks the main filter used to process the signal. It is used in conjunction with the **Memory** button we talked about above. It functions whenever the DSP power is on and the **DSP** button is "in."

**Note:** *Please remember that when we say Tunable, the main filter's bandwidth and frequencies can be adjusted by the two front panel **Tunable Filters** controls. Pre-set means the front panel **Tunable Filters** controls cannot be used to adjust the filter. A Pre-set filter's mark-space frequencies and bandwidth can only be changed by removing the cover and re-programming internal jumpers (see page 4-11).*

When the **Memory** button is "out," the **Filters** switch selects one of the 5 Tunable filters (LR/HR, BP, 2BP, CW, and SSB) or one of the 5 Pre-set filters (RTTY, HF PACKET, AMTOR, PACTOR, and SSTV/FAX/WeFAX).

When the **Memory** button is "in," the **Filters** switch selects any one of ten memory filters you have stored in locations 1 through 10 of the DSP's memory. The **Filters** switch also selects the memory position (1-10) where you can store the last Tunable/Pre-set filter you're using.

*Chapter 5, Filter Description, gives more detailed information on each filter type available with this switch. Chapter 4, Advanced Features, gives more details on using the memory.*



**Tunable Filters Controls**

The **Tunable Filters** knobs, left and right, adjust the center frequency (also called the tone or pitch) and the bandwidth (also called the selectivity) or the lower and upper cutoff frequencies of the 5 Tunable filters selected by the **Filters** switch. These filters are the LR/HR, BP, 2BP, CW and SSB filters.

These controls also adjust the two manual notch frequencies whenever the **Manual Notch** button is "in."

**Note:** *The **manual notch** function uses the same controls as the main filter. That means any time the manual notch is being used, the adjustable filter cannot be changed.*

The following chart tells you what type of adjustment is made by the left and right **Tunable Filters** controls in every front panel adjustable filter position.

<b>Mode</b>	<b>Tunable Filters Left</b>	<b>Tunable Filters Right</b>
<b>LR/HR</b>	lowest freq. you will hear	highest freq. you will hear
<b>BP</b>	center frequency	bandwidth *
<b>2BP</b> *	center frequency 1	center frequency 2
<b>CW</b>	center frequency	bandwidth
<b>SSB</b>	center frequency	bandwidth
<b>Manual Notch</b>	notch frequency 1	notch frequency 2

\* The **2BP** bandwidth (or selectivity) is changed by adjusting the **BP**'s bandwidth before selecting **2BP**.

---

## MFJ-784B Instruction Manual

### Manual Notch Button

When pressed in, this button activates two manually adjustable notch filters. Each filter removes a very narrow range of frequencies or tones. The manual notch operates in every filter mode except when the **DSP** button is out.

The manual notch is often used to notch out one or two unwanted tones on CW, voice or digital modes. A manually adjusted notch is the only type of notch that operates correctly on CW and digital modes. The manual notch can also remove warbling or buzzing carriers that the automatic notch may ignore. The manual notch also causes less audio distortion in voice modes than an automatic notch.

A manual notch does some things better than the automatic notch. In tone modulated modes the automatic notch wouldn't "know" which tone you wanted to hear and which tone was the interference. It would remove the good signals right along with the bad signals. Since the operator can tell which tones are bad, he/she can use the manual notch to remove them.

The **Tunable Filters** left and right knobs adjust the frequency of each notch over the entire audio range of the filter. The manual notch bandwidth is very narrow. Tones within 100 Hz of each notch frequency will be reduced over ten thousand times in volume. If you only need to notch one tone, set the other **Tunable Filters** control to any end of its range. Doing so will prevent the unused notch from hurting the quality of the signal you want to hear.

One thing is a little tricky when using the manual notch. Since the manual notch uses the **Tunable Filters** left and right knobs to adjust the notch frequencies, you must select and adjust the correct main filter *before* using the manual notch. The MFJ-784B always "remembers" the **Tunable Filters** left and right knobs settings when the manual notch is engaged and then the **Tunable Filters** left and right knobs will only adjust the two manual notch frequencies.

Another important thing to remember is when you release the **Manual Notch** button, the main filter will still remain exactly as it was set. The only thing that will happen is the notch will turn off. But if you adjust or move either **Tunable Filters** left or right knob, the main filter will quickly jump to the current control settings. If you don't want to lose your original filter settings, don't touch the **Tunable Filters** left or right knobs after using the manual notch. You can adjust and use the notch as much as you like without affecting the original filter settings whenever the **Manual Notch** button is "in."

### Auto Notch Button

The auto notch does nearly the same job as the manual notch except it finds and removes up to four unwanted tones very effectively. The main advantage of the auto notch is that it hunts down and removes steady tones without any help from you. The auto notch operates *only in* the LR/HR, BP, 2BP, and SSB filters regardless of whether they are saved in memory or not.

With the **Auto Notch** button "in," the MFJ-784B searches for heterodynes or steady tones and instantly removes them. It is so good it can remove four drifting tones at the same time, even if the tones are moving in different directions.

The automatic notch filter has two important limitations. First, it cannot tell the difference between a good tone and a bad tone. Some **Filter** positions are used for receiving tone signals and the auto notch wouldn't have any idea which tone you really want to copy. Therefore, we can't let you use the auto notch in the following **Filters** switch positions: CW, RTTY, HF PACKET, AMTOR, PACTOR, and SSTV/FAX/WeFAX. In these modes the auto notch would remove every signal, not just the bad ones.

Second, the automatic notch cannot tell the difference between a voice and a tone that varies rapidly in volume and pitch. If we made the automatic notch remove all the very fast changing tones, it would also remove tones from voices. If we made the automatic notch work only on the slowest changing tones, it would not follow the drifting or fading tones you didn't want to hear.

Because of this limited operating range, we give you two ways to select how quickly and completely the automatic notch works.

One way you can control the notch speed is by reducing the volume control on your receiver slightly. This will lower any distortion on voices while the automatic notch is being used.

The second way to adjust the automatic notch involves removing the DSP's cover and moving two jumpers to different positions. This adjustment allows you to choose four different levels of what we call auto notch aggressiveness.

We ship the DSP in the least aggressive setting [1]. If you are unhappy with the notch and would like to step the notch performance up a little bit, you can reset the jumpers. Refer to Jumper Settings on page 4-8. Remember that the automatic notch's distortion of voices will get worse if you choose a more aggressive setting.

---

## MFJ-784B Instruction Manual

### Noise Reduction Control

This knob controls how much the noise reduction program reduces random noises. Random noises are noises that do not repeat at exactly the same rate. When this control is in the full clockwise position, random noises are reduced the maximum amount possible. This control's setting can be used in any active filter mode, including while the **Memory** button is "in."

Remember to use the least amount of noise reduction necessary. Turning the **Noise Reduction** control up too far (clockwise) will reduce the audio and cause unnecessary audio distortion and echo. This is an unavoidable side effect of noise reduction at audio frequencies. The slight echo or hollowness in voices occurs from time delays in the filter and the noise reduction program's effect on random peaks in voices.

Turning off the AGC on the DSP may also reduce how much unwanted noise bothers you.

### Noise Reduction Button

This button turns the noise reduction filter on (in) or off (out). The **Noise Reduction** button operates in every filter mode, including the memory positions.

### Volume Control

The **Volume** control adjusts the audio level at the **Headphones Out** and the **Speaker Out** jacks. It does *not* adjust the audio output level at the **Filtered Audio Out** and **To TNC** output ports. The **Filtered Audio Out** has a back panel screwdriver adjustment. This control's position cannot be stored in memory, and it operates all the time. See the block diagram on page 1-4.

### Speaker Button

This button turns the external speaker on (in) or off (out). It operates in any position of the **Memory** button and in every mode as long as the **Power** button is on.

### **DSP Button**

While "in" this button causes the DSP to digitally process the signal. While "out" this button prevents the DSP from doing any digital processing. It operates in any position of the **Memory** button.

Non-processed audio is still available at all the audio outputs when this button is in the out position. The only change is the audio output voltage at all the jacks, including the **Filtered Audio Out** jack, is no longer held constant. The **Volume** control still functions with the headphones and speaker while the **DSP** button is "out."

### **Power Button**

This button controls the power to the DSP. It operates in any position of the **Memory** button.

When the **Power** button is off (out), this switch connects all the input ports to the speaker and headphones outputs. The **Filtered Audio Out** jack and the **To TNC** port become "dead." See the block diagram on page 1-4.

Do not use this switch to bypass the DSP. Use the **DSP** button. You should only use this switch to turn the DSP off after you are completely finished using the DSP.

---

## **Advanced Features**

---

### Contents of This Chapter

▶ Memory Filters	Page 4-2
Saving Memory Filters	Page 4-2
▶ CW Spotting Tone	Page 4-4
Measuring Frequency	Page 4-4
▶ Talk	Page 4-5
Talk Operation	Page 4-5
▶ Jumper Settings	Page 4-8
Talk Settings	Page 4-8
Auto Notch Aggressiveness	Page 4-8
Normal Jumper Settings	Page 4-8
Normal Jumper Settings Chart	Page 4-9
Setting the CW Sidetone Filter	Page 4-10
Pre-set Filters	Page 4-11
Factory Filter Defaults	Page 4-11
Data Mode Jumper Settings Chart	Page 4-12



## MFJ-784B Instruction Manual

- Press and lock the **Memory** button "in." The **PWR** LED will now turn green, indicating the memory filters, and your new filter settings will be saved temporarily until they are saved into a memory position (1-10).

**Note:** From steps 2-4 your filter may not appear to work because the filter position (1-10) is still set to the old memory filter.

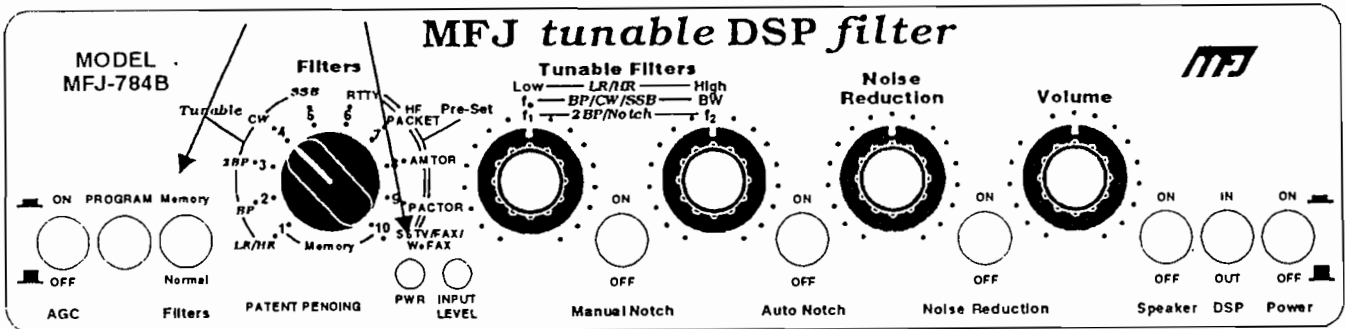

- Turn the **Filters** switch to the position where the new filter is to be saved.

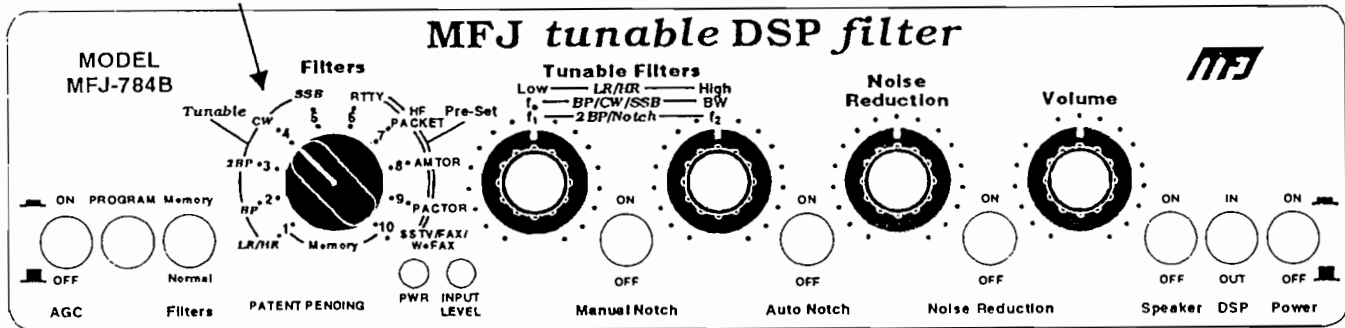

- Press and hold the **Program** button. The LEDs will light *red* and the DSP will beep in one second. Release the **Program** button. This memory position will now operate with these settings whenever memory mode is selected (**Memory** button in).

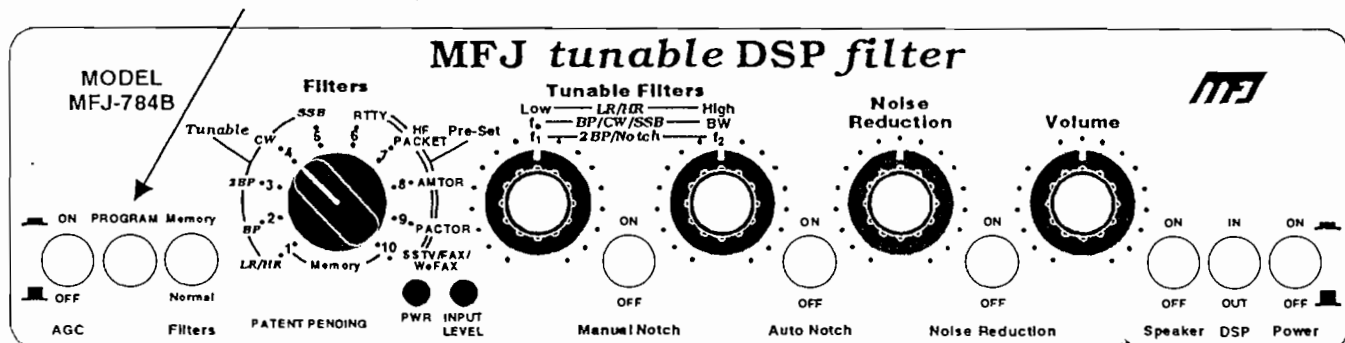



---

## MFJ-784B Instruction Manual

### CW Spotting Tone

To help you find the center frequency for the CW filter, the MFJ-784B is equipped with a CW spotting tone. The spotting tone marks the center frequency of the tunable CW filter and appears when the **Program** button is pushed in while the **DSP** button is in. While the spotting tone is present, the bandwidth of the CW filter is opened to maximum allowing you to "zero in" on any CW signal from 300 Hz to 1000 Hz.

As the spotting tone pitch, adjusted with the **Tunable Filters** left knob, gets close to matching the incoming CW signal's tone, you will hear a beat note. This note will decrease in pitch until a very slow waver or fade is heard in the signals. When this wavering is adjusted to the slowest rate, the center frequency of the CW filter matches the incoming CW signal.

To use the CW spotting tone:

1. Select the CW Filter. The **Filters** switch must be turned to CW and the **Memory** button must be out.
2. Engage the filter by pressing and locking the **DSP** button in.
3. Press and hold the **Program** button to activate the spotting tone.
4. Use the **Tunable Filters** left knob to zero-beat (match) the spotting tone and the CW signal.
5. Release the **Program** button.
6. Decrease the bandwidth with the **Tunable Filters** right knob to eliminate all other signals.

### **Measuring Frequency**

By using the spotting tone, you can measure the approximate frequency of any audio tone between 300 Hz and 1000 Hz.

1. Disengage the **DSP** button out to bypass the filter.
2. Select the CW Filter. The **Filters** switch must be turned to CW and the **Memory** button must be out.
3. Engage the filter by pressing and locking the **DSP** button in.
4. Press and hold the **Program** button to activate the spotting tone.
5. Use the **Tunable Filters** left knob to zero-beat (match) the spotting tone and the signal you wish to measure.
6. Release the **Program** button.
7. Release the **DSP** button. Press and release the **Program** button.
8. Copy the CW. The number following *CF* is the signal's approximate frequency. (You are using Talk. See the Talk section on page 4-5)

### Talk

In order to know more about the settings of the various filters, MFJ has provided the Talk function. Talk tells you filter settings by sending them over the audio outputs and by flashing them on the LEDs in Morse code. This feature is extremely useful if you have forgotten the settings for jumper programmed memory filters and you do not wish to remove the cover to re-program them! When used with the CW spotting tone, this feature also allows you to accurately measure a frequency from 300 Hz to 1000 Hz.

The Talk routine uses the following abbreviations:

- CF* = Center Frequency
- BW* = Bandwidth
- L* = Notch Frequency 1 (Tunable Filters Left Knob)
- R* = Notch Frequency 2 (Tunable Filters Right Knob)
- MN* = Manual Notch
- AN* = Automatic Notch
- NR* = Noise Reduction

Talk will send the following settings for a selected Normal or Memory filter:

- filter mode (LR/HR, BP, 2BP, CW, SSB, RTTY, etc.),
- lower and upper cutoff frequencies or center frequency and bandwidth,
- state of the manual notch and its two notch frequencies,
- state of the auto notch and its aggressiveness level setting (1-4), and
- state of the noise reduction filter and its front panel level (1-10).

The Talk tone frequency and Morse code speed are jumper programmable. Factory default speed is 5 words per minute (WPM) with a 700 Hz pitch. See Jumper Settings on page 4-8.

### **Talk Operation**

To activate the Talk function:

- 1.** Select a filter using the **Filters** switch and the **Memory** button.
- 2.** Set **Volume** to comfortable listening level.
- 3.** Disengage the **DSP** button to "out."
- 4.** Press and release the **Program** button.
- 5.** Listen to the unit send the filter settings (see examples on the next page).
- 6.** At any time, press and lock the **DSP** button to stop the message.

---

## MFJ-784B Instruction Manual

**Examples:** (This is an hypothetical example.)

Suppose you forget what you stored in memory filter 3. You position the controls as follows:

<b>Control</b>	<b>Position</b>	<b>Meaning</b>
<b>Memory</b> button:	in	select memory filters
<b>Filters</b> switch:	3 (2BP)	memory filter 3
<b>Manual Notch</b> button:	out	manual notch off
<b>Auto Notch</b> button:	in	auto notch on
<b>Noise Reduction</b> control:	midrange	reduction level 5
<b>Noise Reduction</b> button:	in	noise reduction on
Auto Notch aggressiveness:	jumper-programmed	level 3

Then release the **DSP** button out, press and release the **Program** button, and the MFJ-784B sends:

*BP CF 1025 BW 350 AN 3 NR 5*

You now know that in memory position 3 you have a narrow band-pass filter with a bandwidth of 350 Hz and center frequency of 1025 Hz. The unit also sent your current settings for notch and noise reduction. Now suppose you try memory filter 6.

Turn the **Filters** switch to 6 (RTTY).

Press the **Program** button and the MFJ-784B sends:

*RTTY CF 1360 BW 279 NR 5*

In this position, you have saved a jumper-programmed RTTY filter with the center frequency of 1360 Hz and a bandwidth of 279 Hz. These are the settings for European RTTY. Notice that there is nothing sent for auto notch because it is disabled in the RTTY filter.

These are examples of the individual filter settings:

### LR/HR

- High-pass/low-pass (LR < HR): *LRHR 2000-3400*
- Band-stop filter (LR > HR): *LRHR 0-1400 2200-3900*
- All-pass filter (LR = HR): *LRHR 0-3900*

### BP

- Normal filter: *BP CF 1500 BW 2100*
- Limited filter: \* *BP CF 675 BW 1350*

**2BP**

- Normal filter: *2BP CF 300 BW 30 CF 3400 BW 30*
- Overlapped filter: \* \* *2BP CF 1000 BW 100*

**CW**

- Filter without sidetone: *CW CF 700 BW 30*
- Filter with CW sidetone: *CW CF 400 BW 50 CF 700 BW 30*
- Overlapped filter: \* \* *CW CF 600 BW 100*

**SSB**

- Normal filter: *SSB CF 900 BW 1000*

**RTTY**

- 2125-2295 Hz 45 baud: *RTTY CF 2210 BW 250*

**HF PACKET**

- 2125-2295 Hz 300 baud: *PCKT CF 2210 BW 504*

**AMTOR**

- 2125-2295 Hz 100 baud: *AMTR CF 2210 BW 304*

**PACKTOR**

- 2125-2295 Hz 200 baud: *PCTR CF 2210 BW 404*

**SSTV/FAX/WeFAX**

- Non-adjustable: *SSTV 1050-1350 1450-2350*

**Manual Notch**

- Manual Notch On: *MN L 150 R 3400*  
[when off, *MN* is not sent]

**Automatic Notch**

- On with aggressive level 3: *AN 3*  
[when off, *AN* is not sent]

**Noise Reduction**

- On with control midrange: *NR 5*  
[when off, *NR* is not sent]

\* A filter is "limited" by the MFJ-784B frequency range of 0-3900 Hz or 175 Hz minimum in SSB. The center frequency and bandwidth for these filters are changed to reflect these limits. See the Limited Filters section in chapter 5.

\*\* An "overlapped" filter occurs when two filters overlap each other resulting in a single filter capable of passing all the frequencies of the two filters.

---

## MFJ-784B Instruction Manual

### Jumper Settings

Several features of the MFJ-784B are varied by internal plug-in jumpers. These jumpers are used for:

Talk:	set CW tone frequency and Morse code speed
Auto Notch:	set aggressiveness level
CW sidetone:	enable and set sidetone filter
Data modes:	program mark-space frequencies and baud rates

### Talk Settings

The Talk routine will "tell" you the DSP's filter settings by sending them in Morse code. Jumpers 1-3 are used for the pitch of the Morse code. Jumpers 4 & 5 are used for the Morse code speed. The DSP is shipped with these jumpers set at 5 WPM and 700 Hz pitch.

### Auto Notch Aggressiveness

We ship the DSP in the least aggressive setting [1]. If you are unhappy with the notch performance and would like to step it up a little bit, you can reset the jumpers. Remember that the automatic notch's distortion of voices will get worse if you choose a more aggressive setting.

### Normal Jumper Settings

Except when programming CW sidetone and data filters, the jumpers are set for the Talk routine and the auto notch aggressiveness settings. After programming a Pre-set data filter or the CW sidetone filter, the jumpers should be returned to their original positions for Talk and auto notch.



**Warning:** *Remove all power plug from the MFJ-784B before removing the cover. Even though the unit is "off," power is still applied to some circuitry.*

To set the tone frequency, code speed, and auto notch level:

1. Disengage [turn "off"] the **Power** button and **remove the power plug**.
2. Remove the unit's cover [6 screws].
3. Set the jumpers according to the jumper setting table on the next page.
4. Replace the unit's cover [6 screws].
5. Reconnect the power cable and resume normal operation.

Normal Jumper Settings Chart

JMP 1	JMP 2	JMP 3		Tone Frequency
L	L	L		300 Hz
L	L	H		400 Hz
L	H	L		500 Hz
L	H	H		600 Hz
H	L	L		700 Hz
H	L	H		800 Hz
H	H	L		900 Hz
H	H	H		*1000 Hz
JMP 4	JMP 5		Code Speed	
L	L		5 wpm	
L	H		10 wpm	
H	L		*20 wpm	
H	H		30 wpm	
JMP 6	JMP 7	Auto Notch Level		
L	L	*1		
L	H	2		
H	L	3		
H	H	4		

\* Factory defaults.

This is what the jumpers should look like for the following settings:

1000 Hz Talk pitch,  
10 WPM Talk Morse code speed,  
and Auto Notch level 1.

			L	H
1000 Hz. Tone Freq.	H	JMP1	<input type="checkbox"/>	<input type="checkbox"/>
	H	JMP2	<input type="checkbox"/>	<input type="checkbox"/>
	H	JMP3	<input type="checkbox"/>	<input type="checkbox"/>
10 WPM	L	JMP4	<input type="checkbox"/>	<input type="checkbox"/>
	H	JMP5	<input type="checkbox"/>	<input type="checkbox"/>
Level 1 Auto Notch	L	JMP6	<input type="checkbox"/>	<input type="checkbox"/>
	L	JMP7	<input type="checkbox"/>	<input type="checkbox"/>
JMP8 is NOT used.			<input type="checkbox"/>	<input type="checkbox"/>

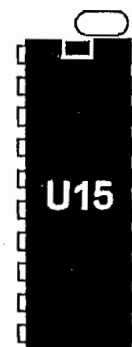

			L	H
700 Hz. Tone Freq.	H	JMP1	<input type="checkbox"/>	<input type="checkbox"/>
	L	JMP2	<input type="checkbox"/>	<input type="checkbox"/>
	L	JMP3	<input type="checkbox"/>	<input type="checkbox"/>
5 WPM	L	JMP4	<input type="checkbox"/>	<input type="checkbox"/>
	L	JMP5	<input type="checkbox"/>	<input type="checkbox"/>
Level 1 Auto Notch	L	JMP6	<input type="checkbox"/>	<input type="checkbox"/>
	L	JMP7	<input type="checkbox"/>	<input type="checkbox"/>
JMP8 is NOT used.			<input type="checkbox"/>	<input type="checkbox"/>

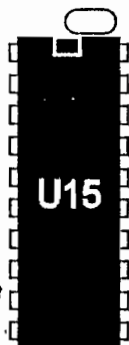

This is what the jumpers should look like for the default settings:

700 Hz Talk pitch,  
5 WPM Talk Morse code speed,  
and Auto Notch level 1.

## MFJ-784B Instruction Manual

### Setting the CW Sidetone Filter

If you do not have a **T/R** connection and wish to pass CW sidetone through the DSP, you must enable this filter. This is not the preferred method to pass sidetone, see page 2-5. The CW sidetone filter is a jumper programmable internal constant frequency filter. It only works in the Tunable CW mode. Any signal within 30 Hz of the sidetone frequency will pass through this filter.

To enable the CW sidetone filter, program it to the sidetone frequency of your radio. The center frequency of the sidetone filter ranges from 300 Hz to 1000 Hz in 50 Hz increments. The bandwidth of the sidetone filter is fixed at 50 Hz. See the chart below for jumper settings.

The DSP unit is shipped with the CW sidetone filter set to "off." If you wish to disable the filter, program it with all four jumpers in the "H" position.

To set the CW sidetone filter:

1. Disengage the **Power** button and *remove the power plug*.
2. Remove the DSP's cover.
3. Set the jumpers for the selected sidetone filter.
4. Turn the **Filters** switch to **CW**.
5. Reconnect power.
6. Press and hold the **Program** button.
7. Press and lock the **Power** button to "on."
8. The DSP will beep at the new sidetone pitch until the **Program** button is released.
9. Disengage the **Power** button and *remove the power plug*.
10. Set the jumpers back to the Talk tone frequency and Morse code speed.
11. Replace the cover.
12. Reconnect the power cable and resume normal operation.

JMP 1	JMP 2	JMP 3	JMP 4	Sidetone Frequency
L	L	L	L	300 Hz
L	L	L	H	350 Hz
L	L	H	L	400 Hz
L	L	H	H	450 Hz
L	H	L	L	500 Hz
L	H	L	H	550 Hz
L	H	H	L	600 Hz
L	H	H	H	650 Hz
H	L	L	L	700 Hz
H	L	L	H	750 Hz
H	L	H	L	800 Hz
H	L	H	H	850 Hz
H	H	L	L	900 Hz
H	H	L	H	950 Hz
H	H	H	L	1000 Hz
H	H	H	H	* OFF

\* Factory default.

**Pre-set Filters**

We have set the RTTY, HF Packet, AMTOR, and PacTOR filters to the most commonly used mark-space frequencies and baud rates. If you wish to change from the factory defaults, you must change the jumpers and program a filter. You may program these filters to a number of mark-space frequencies (shifts) and baud rates. The baud rate setting controls the bandwidth of the filter. Depending on conditions, it is possible to run higher baud rates than are calculated.

The SSTV/FAX/WeFAX filter is fixed. When you program into this position (no change of the jumpers is necessary), the Pre-set filters and CW sidetone (not those in memory filters) will reset to the factory defaults. See below.

To set mark-space frequency or reset the filters to the factory defaults\*:

1. Press and unlock the **Power** button to "off" and *remove the power plug*.
2. Remove the unit's cover (6 screws).
3. Set the jumpers for the selected data filter (see jumper table on next page). Record the Pre-set filter settings with the chart on page A-6.
4. Turn the **Filters** switch to **RTTY, HF PACKET, AMTOR, PACTOR,** or **SSTV/FAX/WeFAX \***.
5. Reconnect the power cable.
6. Press and hold the **Program** button.
7. Press and lock the **Power** button to "on."
8. The unit will beep until the **Program** button is released.
9. Press and unlock the **Power** button to "off" and *remove the power plug*.
10. Set the jumpers back to the Talk tone frequency and Morse code speed and the auto notch aggressiveness level. (Refer to page 4-8.)
11. Replace the unit's cover (6 screws).
12. Reconnect the power cable and resume normal operation.

**\* Factory Filter Defaults**

When you program a filter to the SSTV/FAX/WeFAX position, the following filters (not those stored in memory) are reset to the factory defaults as:

<b>Pre-set Filter</b>	<b>Mark-Space</b>	<b>Baud Rate</b>
RTTY	2125-2295 Hz	45
HF PACKET	2125-2295 Hz	300
AMTOR	2125-2295 Hz	100
PACTOR	2125-2295 Hz	200
CW Sidetone	Set to OFF	



# MFJ-784B Instruction Manual

## Data Mode Jumper Settings Chart

JMP 1	JMP 2	JMP 3	JMP 4		Mark-Space (Shift)		
L	L	L	L		1215-1385 Hz (170)		
L	L	L	H		1275-1445 Hz (170)		
L	L	H	L		1415-1585 Hz (170)		
L	L	H	H		1615-1785 Hz (170)		
L	H	L	L		*2125-2295 Hz (170)		
L	H	L	H		1200-1400 Hz (200)		
L	H	H	L		1260-1460 Hz (200)		
L	H	H	H		1430-1630 Hz (200)		
H	L	L	L		1600-1800 Hz (200)		
H	L	L	H		2025-2225 Hz (200)		
H	L	H	L		2110-2310 Hz (200)		
H	L	H	H		2125-2325 Hz (200)		
H	H	L	L		1275-1700 Hz (425)		
H	H	L	H		2125-2550 Hz (425)		
H	H	H	L		1275-2125 Hz (850)		
H	H	H	H		2125-2975 Hz (850)		
				JMP 5	JMP 6	JMP 7	Baud Rate
				L	L	L	*45
				L	L	H	57
				L	H	L	75
				L	H	H	*100
				H	L	L	110
				H	L	H	150
				H	H	L	*200
				H	H	H	*300

\* Factory defaults.

Data filter center frequency = (mark + space) ÷ 2

Data filter bandwidth = (1.2 x shift) + baud rate (reference: ARRL Handbook)

---

## Filter Description

---

### Contents of This Chapter

▶ LR/HR Filter [1]	Page 5-2
Band-stop Filter	Page 5-3
▶ BP Filter [2]	Page 5-4
▶ 2BP Filter [3]	Page 5-5
▶ CW Filter [4]	Page 5-6
CW Sidetone Filter	Page 5-6
▶ SSB Filter [5]	Page 5-7
▶ RTTY Filter [6]	Page 5-7
▶ HF PACKET Filter [7]	Page 5-7
▶ AMTOR Filter [8]	Page 5-8
▶ PACTOR Filter [9]	Page 5-8
▶ SSTV/FAX/WeFAX Filter [10]	Page 5-8
▶ Manual Notch Filter	Page 5-9
▶ Automatic Notch Filter	Page 5-10
▶ Noise Reduction Filter	Page 5-10
▶ Limited Filters	Page 5-11

---

## MFJ-784B Instruction Manual

The following section describes the filters available in the various **Filters** switch positions in detail. All graphs of the following filters show a line at the noise floor of -55 dB. The response for these digital filters is typically much deeper than -55 dB but circuit noise will generally mask any response below that point.

### **LR/HR Filter [1]**

Use: Custom Voice, FSK, Wide CW Filter.  
Passes medium to wide frequency width.

This position selects an adjustable low reject/high reject filter. The low reject filter (**Low**) removes all signals below a user-selected frequency. The low reject filter cutoff frequency can be varied between 200 Hz and 2200 Hz with the **Tunable Filters** left knob. The high reject filter (**High**) removes all signals above the selected frequency. The high reject limit is adjustable between 1400 Hz and 3400 Hz with the **Tunable Filters** right knob.

***For example:** If the low reject filter is adjusted to 900 Hz and the high reject filter is adjusted to 2500 Hz, all frequencies below 900 Hz and above 2500 Hz will be rejected. In this case, the DSP filter will only pass frequencies from 900 Hz to 2500 Hz.*

**Typical Low Reject/High Reject Filter Response**

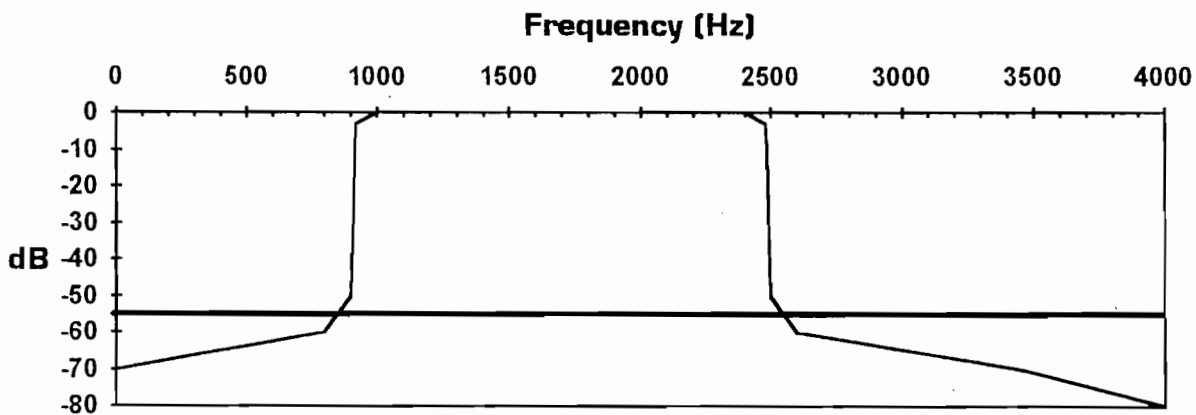

**Band-stop Filter**

Use: Rejecting broad or variable frequency signals between 1400-2200 Hz.  
Removes medium to wide frequency width.

When the low reject filter, the **Tunable Filters** left knob, is adjusted to a frequency higher than the high reject filter, the **Tunable Filters** right knob, the filter removes all frequencies between the two filter settings and passes all frequencies outside the settings of the two filters. This special filter is called a *band-stop* filter. A band-stop filter makes a "hole" in the middle of the frequency range and passes everything on either side of the "hole."

*For example: If the low reject filter is adjusted to 2200 Hz and the high reject filter is adjusted to 1600 Hz, all frequencies between 1600 Hz and 2200 Hz will be removed. This creates a hole with a 600 Hz bandwidth.*

**Typical Band-stop Filter Response**

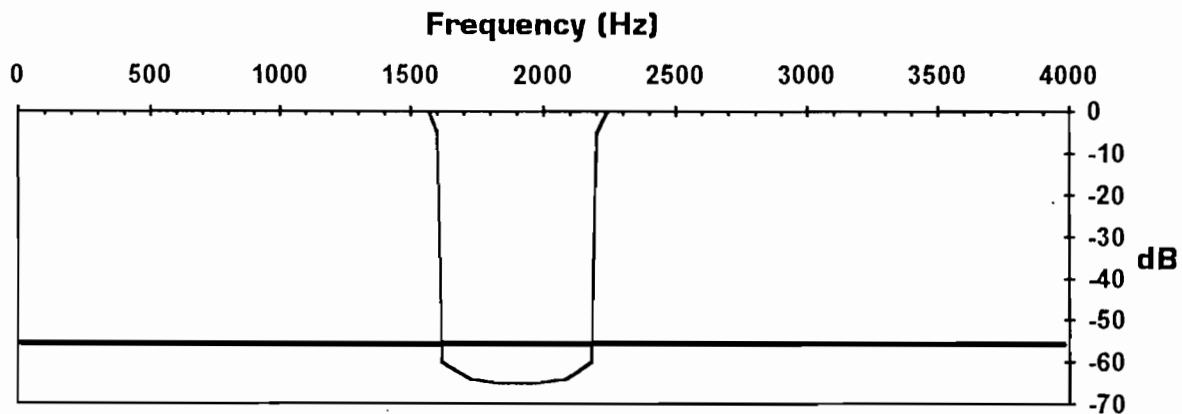

---

## MFJ-784B Instruction Manual

### **BP Filter [2]**

Use: Custom Voice, FSK, Custom CW Filter.  
Passes narrow to wide frequency width.

This filter is an adjustable band-pass filter. The bandwidth (**BW**) is controlled by the **Tunable Filters** right knob. This adjustment is similar to the selectivity control on a receiver. It can be adjusted from 30 Hz to 2100 Hz. The **Tunable Filters** left knob varies the center frequency (**fc**) between 300 Hz and 3400 Hz. This adjustment is very much like the pass band tuning or IF shift control on high quality receivers.

***For example:** If the center frequency (**fc**) is adjusted to 2200 Hz and the bandwidth (**BW**) is adjusted to 600 Hz, all frequencies between 1900 Hz and 2500 Hz will pass. All frequencies not in the 600 Hz bandwidth will be attenuated.*

**Typical Band-pass Filter Response**

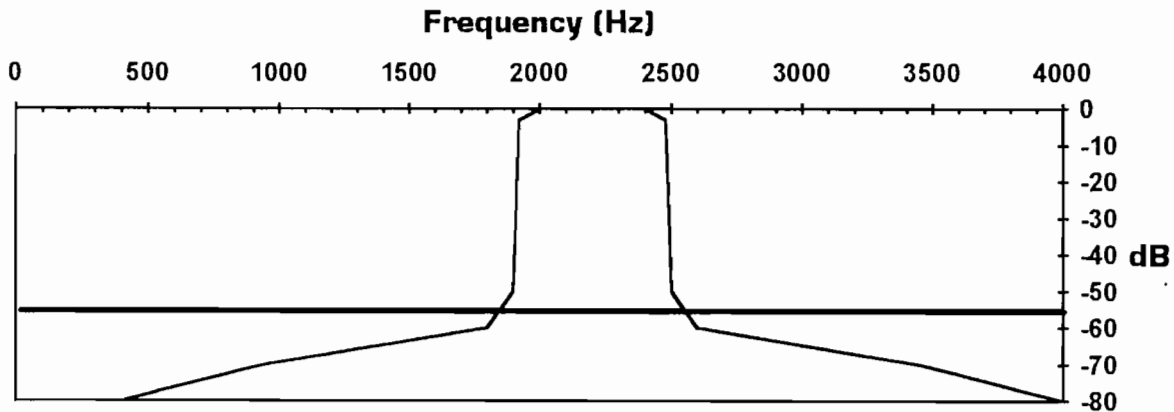

**2BP Filter [3]**

Use: Custom Voice, FSK, Dual Pitch CW Filter.

Passes 2 independent narrow to wide frequency ranges.

This position allows the use of two frequency-independent variable band-pass filters in parallel. The **Tunable Filters** left and right knobs control the individual center frequencies (**f1** & **f2**) of the filters.

Each filter has the same bandwidth. The **2BP** position uses the bandwidth setting from the **BP** filter. The bandwidth can be adjusted by switching to the **BP** position and adjusting the **Tunable Filters** right knob.

**For Example:** *To adjust the bandwidth of the **2BP** filter, the **Tunable Filters** right knob is adjusted to 200 Hz bandwidth while **Filters** switch is in the **BP** position. The **Filters** switch is then turned to **2BP**. Now two filters are available, with the **Tunable Filters** left knob controlling the center frequency (**f1**) of one 200 Hz filter and the **Tunable Filters** right knob controlling the center frequency (**f2**) of a second 200 Hz filter.*

**Typical Dual Band-pass Filter Response**

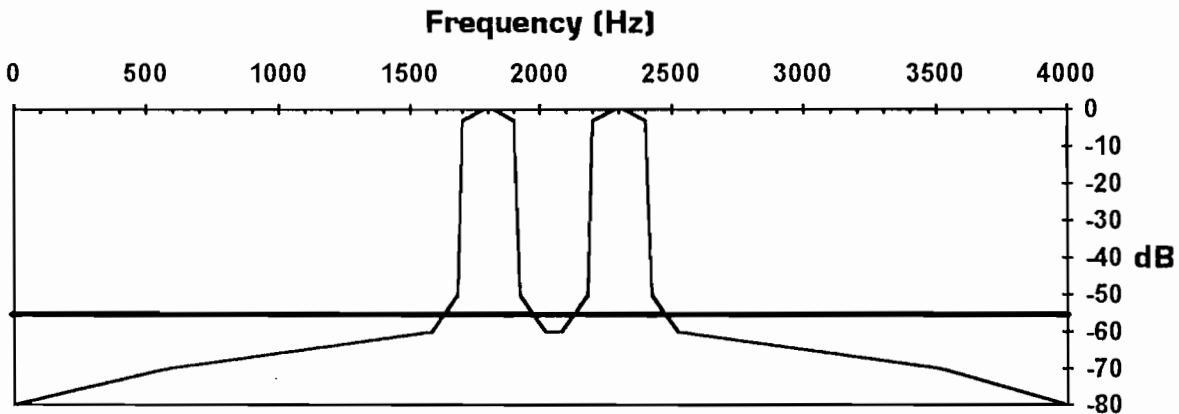

---

## MFJ-784B Instruction Manual

### **CW Filter [4]**

Use: CW Filter, Narrow FSK.

Passes "razor sharp" to medium frequency width.

The CW filter is an adjustable band-pass filter that can be varied over the normal frequency range preferred by most CW enthusiasts.

The center frequency (or pitch) is controlled by the **Tunable Filters** left knob and has a frequency range of 300 Hz to 1000 Hz. This control functions similarly to the pass band tuning or the IF shift control of a receiver with this filter.

The **Tunable Filters** right knob adjusts the filter bandwidth from 30 Hz to 700 Hz. This knob acts exactly like the selectivity control on a receiver.

Note that as the bandwidth of this filter approaches the on-off rate of the dot and dashes, some ringing may appear. This is an inherent characteristic of any filter when the bandwidth approaches the on-off rate. When this filter is operated using a very narrow bandwidth, some ringing or softening is inevitable. To minimize ringing use the maximum bandwidth possible.

### **CW Sidetone Filter**

Use: To pass CW sidetone

Passes any signal very near programmed center frequency.

**Note:** *This is not the preferred method for passing sidetone. This filter will pass unwanted signals within 30 Hz of the sidetone frequency. See page 2-5, Passing Sidetone.*

The CW sidetone filter is a constant frequency filter used to pass sidetone through the DSP. It makes the unit operate as two separate parallel filters: one normal tunable or memory CW filter and the other a constant frequency sidetone filter.

The CW sidetone filter is set at 50 Hz bandwidth. The filter is jumper programmable to center frequencies from 300 Hz to 1000 Hz in 50 Hz increments.

**SSB Filter [5]**

Use: All Voice modes, FSK, CW Filter.  
Passes medium to wide frequency width.

The SSB filter is a band-pass filter with adjustable center frequency and bandwidth. The center frequency (**fc**) is adjusted with the **Tunable Filters** left knob in a range of 600 Hz to 1700 Hz. The **Tunable Filters** right knob adjusts the bandwidth (**BW**) from 1000 Hz to 2500 Hz. The actual filter response is limited internally to a minimum of 175 Hz.

While some voice transmissions may be understandable with only 1000 Hz of bandwidth if the center frequency is properly adjusted, the majority of stations will be copied best with the controls nearly centered. The optimum center frequency and bandwidth setting will be determined by the transmitting operator's voice, the transmitter's response, the receiver's response, any noise or QRM, and/or the receiving operator's hearing.

The operator may prefer to monitor himself/herself in the transmit mode. Refer to the section called Passing Sidetone on page 2-5.

**RTTY Filter [6]**

Use: RTTY, FSK.  
Passes high frequency tones with narrow frequency width.

The RTTY filter is factory pre-set for best performance with standard 2125-2295 Hz mark-space frequencies (170 Hz shift), 45 baud RTTY signals. This filter can also be programmed to one of several different mark-space frequencies and/or baud rates. This procedure is detailed on page 4-11. Under special conditions the operator may wish to use one of the adjustable band-pass filters in place of the RTTY filter.

**HF PACKET Filter [7]**

Use: Packet, Wide RTTY, FSK.  
Passes high frequency tones with medium frequency width.

The HF Packet filter is factory pre-set for best performance with standard 2125-2295 Hz mark-space frequencies (170 Hz shift), 300 baud HF Packet signals. This filter can also be programmed to one of several different mark-space frequencies and/or baud rates. This procedure is detailed on page 4-11. Under special conditions the operator may wish to use one of the adjustable band-pass filters in place of the HF Packet filter.



---

## **MFJ-784B Instruction Manual**

### **AMTOR Filter [8]**

Use: AMTOR, Narrow PACTOR, Wide RTTY, FSK.

Passes high frequency tones with narrow frequency width.

The AMTOR filter is factory pre-set for best performance with standard 2125-2295 Hz mark-space frequencies (170 Hz shift), 100 baud AMTOR signals. This filter can also be programmed to one of several different mark-space frequencies and/or baud rates. This procedure is detailed on page 4-11. Under special conditions the operator may wish to use one of the adjustable band-pass filters in place of the AMTOR filter.

### **PACTOR Filter [9]**

Use: PACTOR, Narrow Packet, Wide RTTY.

Passes high frequency tones with medium frequency width.

The PACTOR filter is factory pre-set for best performance with standard 2125-2295 Hz mark-space frequencies (170 Hz shift), 200 baud PACTOR signals. This filter can also be programmed to one of several different mark-space frequencies and/or baud rates. This procedure is detailed on page 4-11. Under special conditions the operator may wish to use one of the adjustable band-pass filters in place of the PACTOR filter.

### **SSTV/FAX/WeFAX Filter [10]**

Use: Slow Scan, Facsimile.

Passes two separate frequency ranges, one narrow and one wide frequency width.

This filter is a dual band-pass filter that allows two separate frequency groups to pass through the filter. The first filter is pre-set to pass frequencies between 1050 Hz and 1350 Hz for the synch tone and the Vertical Interval Signal (VIS) tones. The picture content is passed by a second filter at 1450 Hz to 2350 Hz. This filter is non-adjustable and cannot be programmed to different frequencies.

**Manual Notch Filter**

Use: Removes unwanted tones or heterodynes.

Removes up to 2 very narrow frequency ranges and passes all others.

The manual notch filter allows the use of two frequency-independent manually tunable notch filters. The **Tunable Filters** left and right knobs control the individual notch frequencies (**f1** & **f2**).

The manual notch has two different frequency ranges and widths: one for the CW filter and one for the other filters. When using the CW filter the notch is narrower, 45 Hz @ -40 dB, and has a frequency range of 300 Hz to 1000 Hz (same as the CW filter). In all other modes the notch is wider, 85 Hz @ -40 dB, and has a frequency range of 150 Hz to 3400 Hz.

**For Example:** *There is RTTY in your SSB audio. After engaging the **Manual Notch** button, use the **Tunable Filters** left and right knobs to notch the two RTTY tones at 2125 and 2295 Hz.*

**Typical Manual Notch Filter Response**

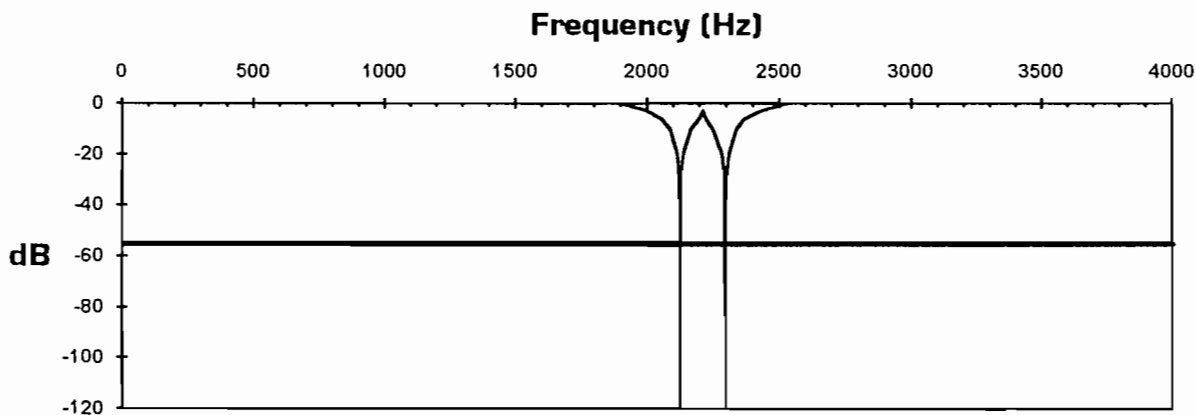

---

## **MFJ-784B Instruction Manual**

### **Automatic Notch Filter**

Use: Removes multiple tones or heterodynes quickly.  
Removes up to 4 changing tones in the presence of speech signals.

The multiple automatic notch filter searches for and eliminates up to four changing or shifting tones in milli-seconds, with attenuation as great as 50 dB. All the notches are extremely narrow, resulting in a minimal effect on the voice signals. The automatic notch filter is disabled in the following **Filters** switch positions: CW, RTTY, HF PACKET, AMTOR, PACTOR, and SSTV/FAX/WeFAX (including those stored in memory).

There is an adjustment to change the "speed" of the automatic notch filter. We call this adjustment the automatic notch aggressiveness. By changing a jumper setting, this aggressiveness can be changed in a range of four levels. See the jumper setting section on page 4-8.

### **Noise Reduction Filter**

Use: Removes random noises such as white noise, background hiss, etc.  
Removes random noises and passes coherent signals like voices.

The random noise reduction filter effectively removes noises in the presence of voice with minimal degradation of the voice itself. The noise reduction filter works by automatically forming constantly-varying band-pass filters around the coherent components, such as speech, of the audio signal. In effect, this provides noise reduction by reducing the individual filters' bandwidths to the minimum required to pass the speech signals intelligently. This filter greatly reduces operator fatigue during long-term monitoring and makes listening much more pleasant.

There is a noise reduction control to adjust the reduction characteristics of the noise reduction filter to prevent signal distortion. When this control is in the full clockwise position, random noises can be attenuated up to 20 dB (depending on the types of noises).

### **Limited Filters**

Filter response is limited to the frequency range of 0-3900 Hz or 175 Hz minimum in **SSB** mode. When a filter's center frequency setting is low or high enough that the bandwidth would exceed these frequency ranges, the filter is "limited." The filter actually changes its center frequency and bandwidth settings so that it does not exceed these frequency ranges.

Limited filters are probably not even noticed by the casual operator. However when using the Talk feature, an operator may notice a difference in the front panel controls and the **Tunable Filters** left and right knob settings.

**For example:** The **Filters** switch is set to **BP**. The **Tunable Filters** left knob is set at a 300 Hz center frequency and the **Tunable Filters** right knob is set to a bandwidth of 2000 Hz. Obviously the lower cutoff frequency cannot be -700 Hz. Since the DSP's frequency range stops at zero, the filter must stop at zero. The filter's upper cutoff frequency is 1000 Hz above the center frequency, 1300 Hz. In this case, the DSP limits the **BP** filter to 0-1300 Hz (a low-pass filter). Therefore when the Talk feature is used, the DSP will send the following:

*BP CF 650 BW 1300*

## **Appendix**

---

### Contents of This Appendix

- ▶ Self-Test Page A-2
- ▶ In Case of Difficulty Page A-4
- ▶ Technical Assistance Page A-4
- ▶ Radio to TNC Cables Page A-5
  - MFJ-784B to PK-232 Connections Page A-5
  - MFJ-784B to PK-88 Connections Page A-5
- ▶ Pre-set and Memory Filters Settings Chart Page A-6

---

## MFJ-784B Instruction Manual

### Self-Test

This self-test is used to test all the digital circuitry, switches, and controls of the MFJ-784B.

To perform the self-test:

1. Turn the **Filters** switch to **BP**.
2. Push all buttons so they are in the "out" position.
3. Turn all knobs to full clockwise, except **Volume**. Set **Volume** to a comfortable listening level.
4. Disengage the **Power** button and *remove the power plug*.
5. Remove the DSP's cover (6 screws).
6. Remove all jumpers from JMP1 to JMP7. Record their positions to re-configure the unit after the self-test.
7. Reconnect power.
8. Press and hold the **Program** button.
9. Press and lock the **Power** button to "on."
10. Release the **Program** button. The unit sends *SELF TEST* in Morse code at 10 WPM. For the entire test, the LEDs should blink green once after each operation. If the LEDs blink red the unit fails the test and a Morse code message is sent to indicate the nature of the failure.
11. Test each button (except the **Speaker** and **Power** buttons) by pressing: **AGC**, **Program**, **Memory**, **Manual Notch**, **Auto Notch**, **Noise Reduction**, and **DSP** buttons. Skip the **Speaker** and **Power** buttons. The LEDs should blink green once after each button push.
12. Test the **Filters** switch by turning it to each position: **LR/HR**, **BP**, **2BP**, **CW**, **SSB**, **RTTY**, **HF PACKET**, **AMTOR**, **FACTOR**, and **SSTV/FAX/WeFAX**. The LEDs should blink green once after each turn of the switch.
13. Test the left **Tunable Filters** knob by turning it to full counter-clockwise then to full clockwise. The LEDs should blink green once at each end.
14. Test the right **Tunable Filters** and **Noise Reduction** knobs in the same way. The LEDs should blink green once at each end.
15. Test the jumper connections by placing plug-in jumpers on the "L" positions of JMP1-JMP7 (JMP8 is not used).

**Important:** *Performing the next step will reset the CW sidetone and the Pre-set data filters to factory defaults as described on page 4-11. If you do not want these filters to reset to factory defaults, stop this self-test now by releasing the **Power** button.*

16. Test the **T/R** line by shorting pin 5 of the **To Radio** connector to ground for approximately one second or until the LEDs blink. If it is shorted for less than one second, the DSP might signal a false failure.
17. The filter EEPROM memory, IC U8, is then tested without assistance. Note that this step will reset the CW sidetone and the Pre-set data filters to factory defaults.
18. If you've pressed the buttons, turned the switch and the knobs, placed the jumpers, and grounded the T/R sense line in the correct order and the unit is working properly, the unit repeatedly sends *OK-784* in Morse code. A repetitive message such as *B4 FAIL* indicates that you didn't follow the correct order or the unit failed the test. The prefix and the number indicate the nature of the failure [see table below].
19. Disengage the **Power** button and ***remove the power plug***.
20. Replace all jumpers from JMP1 to JMP7 to their original positions.
21. Replace the DSP's cover (6 screws).
22. Reconnect power and resume with normal operation.

### Prefix-Number and Its Designation

B1 = AGC button	S1 = LR/HR switch position
B2 = PROGRAM button	S2 = BP switch position
B3 = MEMORY button	S3 = 2BP switch position
B4 = MANUAL NOTCH button	S4 = CW switch position
B5 = AUTO NOTCH button	S5 = SSB switch position
B6 = NOISE REDUCTION button	S6 = RTTY switch position
B7 = SPEAKER button *	S7 = HF PACKET switch position
B8 = DSP button	S8 = AMTOR switch position
B9 = POWER button *	S9 = PACTOR switch position
J1 = JMP1 jumper	S0 = SSTV/FAX/WeFAX switch position
J2 = JMP2 jumper	K1 = TUNABLE FILTERS left knob
J3 = JMP3 jumper	K2 = TUNABLE FILTERS right knob
J4 = JMP4 jumper	K3 = NOISE REDUCTION knob
J5 = JMP5 jumper	K4 = VOLUME knob *
J6 = JMP6 jumper	TR = T/R sense -- TO RADIO DIN pin 5
J7 = JMP7 jumper	EE = EEPROM -- IC U8

\* *These controls are included here for completeness even though they are not tested by this self-test.*

---

## MFJ-784B Instruction Manual

### In Case of Difficulty

**If you experience low volume, hum only when the DSP volume control is high, or distortion:**

Double check the wiring used to connect the DSP to the receiver's speaker and headphones jacks. The wiring can be tested by turning the DSP "off". When the DSP power switch is in the "off" position, the audio input jack is connected directly to the DSP's speaker and headphones jacks. If the DSP is properly connected and the wiring is good, the volume level and audio quality should be exactly the same as when the speaker or headphones is plugged directly into the receiver's speaker or headphones jacks.

**If the DSP fails to process properly when using the Automatic Notch or Noise Reduction, or if the DSP audio is distorted intermittently:**

The receiver's volume or the DSP's level control may need to be adjusted. Check the **Input Level** LED.

**If you hear hum at high or low volume:**

The power supply you are using may not be filtered properly.

**If the DSP won't start or shuts off intermittently:**

The power supply may not be within the required 10-16 volt range. If the power supply drops below 10 volts from poor regulation or a bad connection, the DSP may operate erratically. An indication of poor power is the power LED flashing from red and green.

### Technical Assistance

If you have any problem with this unit first check the appropriate section of this manual. If the manual does not reference your problem or your problem is not solved by reading the manual you may call *MFJ Technical Service* at **662-323-0549** or the *MFJ Factory* at **662-323-5869**. You will be best helped if you have your unit, manual and all information on your station handy so you can answer any questions the technicians may ask.

You can also send questions by mail to MFJ Enterprises, Inc., 300 Industrial Park Road, Starkville, MS 39759; by FAX to 662-323-6551 or by email to [techinfo@mfjenterprises.com](mailto:techinfo@mfjenterprises.com). Send a complete description of your problem, an explanation of exactly how you are using your unit and a complete description of your station.



**Radio to TNC Cables**

**MFJ-784B to PK-232 Connections**

This cable is available pre-made from MFJ. Order model number MFJ-5100X.

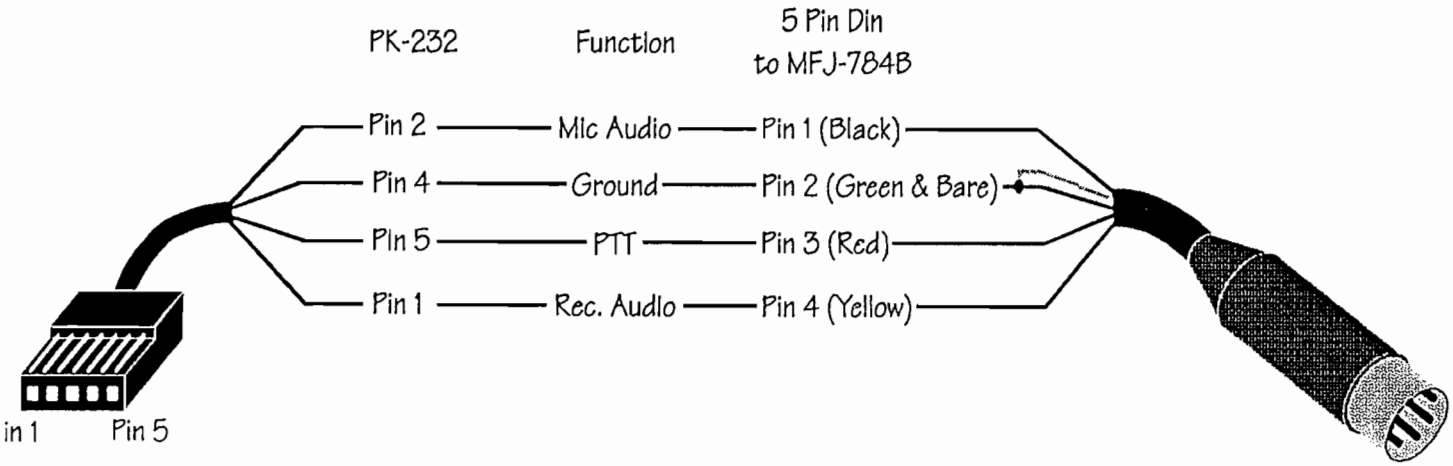

**MFJ-784B to PK-88 Connections**

This cable is available pre-made from MFJ. Order model number MFJ-5100Z.

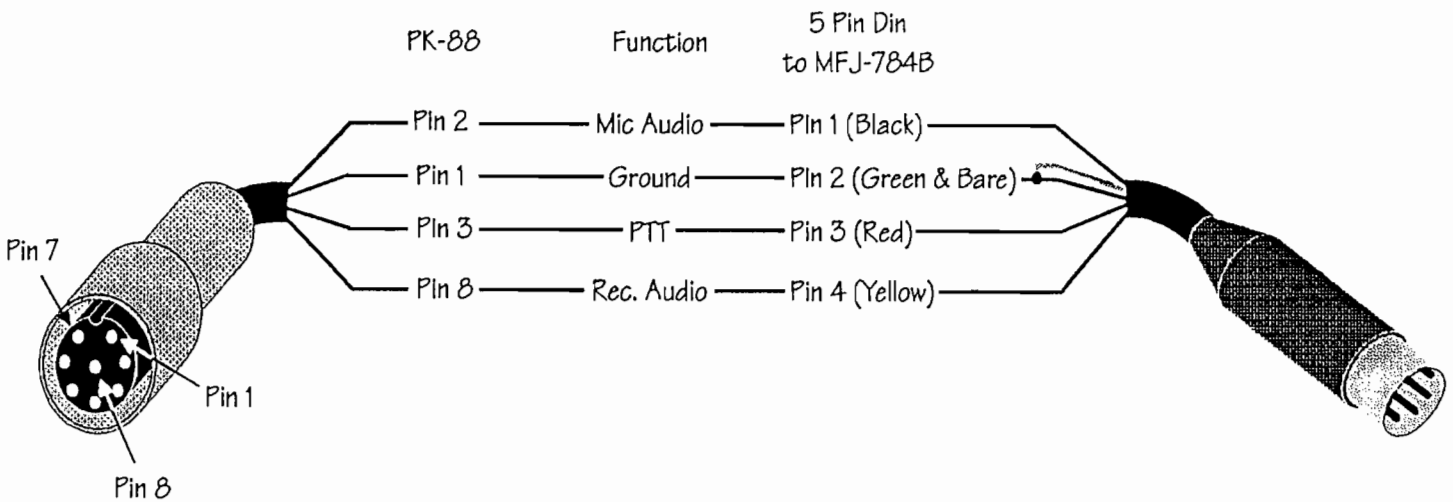

# MFJ-784B Instruction Manual

## Pre-set and Memory Filters Settings Chart

Copy this chart and use it to record your Pre-set and memory filters settings. Use the Talk function to get the frequency values for CF, BW, and/or LR-HR.

<b>Pre-set RTTY Mode</b> Mark-Space _____ Baud Rate _____	<b>Pre-set HF PACKET Mode</b> Mark-Space _____ Baud Rate _____
<b>Pre-set AMTOR Mode</b> Mark-Space _____ Baud Rate _____	<b>Pre-set PACTOR Mode</b> Mark-Space _____ Baud Rate _____
<b>Memory 1</b> Mode: _____ Operation Conditions/Radio Frequency _____ _____ CF, BW _____ LR-HR _____	<b>Memory 2</b> Mode: _____ Operation Conditions/Radio Frequency _____ _____ CF, BW _____ LR-HR _____
<b>Memory 3</b> Mode: _____ Operation Conditions/Radio Frequency _____ _____ CF, BW _____ LR-HR _____	<b>Memory 4</b> Mode: _____ Operation Conditions/Radio Frequency _____ _____ CF, BW _____ LR-HR _____
<b>Memory 5</b> Mode: _____ Operation Conditions/Radio Frequency _____ _____ CF, BW _____ LR-HR _____	<b>Memory 6</b> Mode: _____ Operation Conditions/Radio Frequency _____ _____ CF, BW _____ LR-HR _____
<b>Memory 7</b> Mode: _____ Operation Conditions/Radio Frequency _____ _____ CF, BW _____ LR-HR _____	<b>Memory 8</b> Mode: _____ Operation Conditions/Radio Frequency _____ _____ CF, BW _____ LR-HR _____
<b>Memory 9</b> Mode: _____ Operation Conditions/Radio Frequency _____ _____ CF, BW _____ LR-HR _____	<b>Memory 10</b> Mode: _____ Operation Conditions/Radio Frequency _____ _____ CF, BW _____ LR-HR _____

**Pre-set and Memory Filters Settings Chart**

Copy this chart and use it to record your Pre-set and memory filters settings. Use the Talk function to get the frequency values for CF, BW, and/or LR-HR.

<p><b>Pre-set RTTY Mode</b>                      Mark-Space _____                      Baud Rate _____</p>	<p><b>Pre-set HF PACKET Mode</b>                      Mark-Space _____                      Baud Rate _____</p>
<p><b>Pre-set AMTOR Mode</b>                      Mark-Space _____                      Baud Rate _____</p>	<p><b>Pre-set PACTOR Mode</b>                      Mark-Space _____                      Baud Rate _____</p>
<p><b>Memory 1</b> Mode: _____                      Operation Conditions/Radio Frequency                      _____                      _____                      CF, BW _____                      LR-HR _____</p>	<p><b>Memory 2</b> Mode: _____                      Operation Conditions/Radio Frequency                      _____                      _____                      CF, BW _____                      LR-HR _____</p>
<p><b>Memory 3</b> Mode: _____                      Operation Conditions/Radio Frequency                      _____                      _____                      CF, BW _____                      LR-HR _____</p>	<p><b>Memory 4</b> Mode: _____                      Operation Conditions/Radio Frequency                      _____                      _____                      CF, BW _____                      LR-HR _____</p>
<p><b>Memory 5</b> Mode: _____                      Operation Conditions/Radio Frequency                      _____                      _____                      CF, BW _____                      LR-HR _____</p>	<p><b>Memory 6</b> Mode: _____                      Operation Conditions/Radio Frequency                      _____                      _____                      CF, BW _____                      LR-HR _____</p>
<p><b>Memory 7</b> Mode: _____                      Operation Conditions/Radio Frequency                      _____                      _____                      CF, BW _____                      LR-HR _____</p>	<p><b>Memory 8</b> Mode: _____                      Operation Conditions/Radio Frequency                      _____                      _____                      CF, BW _____                      LR-HR _____</p>
<p><b>Memory 9</b> Mode: _____                      Operation Conditions/Radio Frequency                      _____                      _____                      CF, BW _____                      LR-HR _____</p>	<p><b>Memory 10</b> Mode: _____                      Operation Conditions/Radio Frequency                      _____                      _____                      CF, BW _____                      LR-HR _____</p>

# MFJ-784B Instruction Manual

## Pre-set and Memory Filters Settings Chart

Copy this chart and use it to record your Pre-set and memory filters settings. Use the Talk function to get the frequency values for CF, BW, and/or LR-HR.

<b>Pre-set RTTY Mode</b> Mark-Space _____ Baud Rate _____	<b>Pre-set HF PACKET Mode</b> Mark-Space _____ Baud Rate _____
<b>Pre-set AMTOR Mode</b> Mark-Space _____ Baud Rate _____	<b>Pre-set PACTOR Mode</b> Mark-Space _____ Baud Rate _____
<b>Memory 1</b> Mode: _____ Operation Conditions/Radio Frequency _____ _____ CF, BW _____ LR-HR _____	<b>Memory 2</b> Mode: _____ Operation Conditions/Radio Frequency _____ _____ CF, BW _____ LR-HR _____
<b>Memory 3</b> Mode: _____ Operation Conditions/Radio Frequency _____ _____ CF, BW _____ LR-HR _____	<b>Memory 4</b> Mode: _____ Operation Conditions/Radio Frequency _____ _____ CF, BW _____ LR-HR _____
<b>Memory 5</b> Mode: _____ Operation Conditions/Radio Frequency _____ _____ CF, BW _____ LR-HR _____	<b>Memory 6</b> Mode: _____ Operation Conditions/Radio Frequency _____ _____ CF, BW _____ LR-HR _____
<b>Memory 7</b> Mode: _____ Operation Conditions/Radio Frequency _____ _____ CF, BW _____ LR-HR _____	<b>Memory 8</b> Mode: _____ Operation Conditions/Radio Frequency _____ _____ CF, BW _____ LR-HR _____
<b>Memory 9</b> Mode: _____ Operation Conditions/Radio Frequency _____ _____ CF, BW _____ LR-HR _____	<b>Memory 10</b> Mode: _____ Operation Conditions/Radio Frequency _____ _____ CF, BW _____ LR-HR _____

**Pre-set and Memory Filters Settings Chart**

Copy this chart and use it to record your Pre-set and memory filters settings. Use the Talk function to get the frequency values for CF, BW, and/or LR-HR.

<b>Pre-set RTTY Mode</b> Mark-Space _____ Baud Rate _____	<b>Pre-set HF PACKET Mode</b> Mark-Space _____ Baud Rate _____
<b>Pre-set AMTOR Mode</b> Mark-Space _____ Baud Rate _____	<b>Pre-set PACTOR Mode</b> Mark-Space _____ Baud Rate _____
<b>Memory 1</b> Mode: _____ Operation Conditions/Radio Frequency _____ _____ CF, BW _____ LR-HR _____	<b>Memory 2</b> Mode: _____ Operation Conditions/Radio Frequency _____ _____ CF, BW _____ LR-HR _____
<b>Memory 3</b> Mode: _____ Operation Conditions/Radio Frequency _____ _____ CF, BW _____ LR-HR _____	<b>Memory 4</b> Mode: _____ Operation Conditions/Radio Frequency _____ _____ CF, BW _____ LR-HR _____
<b>Memory 5</b> Mode: _____ Operation Conditions/Radio Frequency _____ _____ CF, BW _____ LR-HR _____	<b>Memory 6</b> Mode: _____ Operation Conditions/Radio Frequency _____ _____ CF, BW _____ LR-HR _____
<b>Memory 7</b> Mode: _____ Operation Conditions/Radio Frequency _____ _____ CF, BW _____ LR-HR _____	<b>Memory 8</b> Mode: _____ Operation Conditions/Radio Frequency _____ _____ CF, BW _____ LR-HR _____
<b>Memory 9</b> Mode: _____ Operation Conditions/Radio Frequency _____ _____ CF, BW _____ LR-HR _____	<b>Memory 10</b> Mode: _____ Operation Conditions/Radio Frequency _____ _____ CF, BW _____ LR-HR _____

# MFJ-784B Instruction Manual

## Pre-set and Memory Filters Settings Chart

Copy this chart and use it to record your Pre-set and memory filters settings. Use the Talk function to get the frequency values for CF, BW, and/or LR-HR.

<b>Pre-set RTTY Mode</b> Mark-Space _____ Baud Rate _____	<b>Pre-set HF PACKET Mode</b> Mark-Space _____ Baud Rate _____
<b>Pre-set AMTOR Mode</b> Mark-Space _____ Baud Rate _____	<b>Pre-set PACTOR Mode</b> Mark-Space _____ Baud Rate _____
<b>Memory 1</b> Mode: _____ Operation Conditions/Radio Frequency _____ _____ CF, BW _____ LR-HR _____	<b>Memory 2</b> Mode: _____ Operation Conditions/Radio Frequency _____ _____ CF, BW _____ LR-HR _____
<b>Memory 3</b> Mode: _____ Operation Conditions/Radio Frequency _____ _____ CF, BW _____ LR-HR _____	<b>Memory 4</b> Mode: _____ Operation Conditions/Radio Frequency _____ _____ CF, BW _____ LR-HR _____
<b>Memory 5</b> Mode: _____ Operation Conditions/Radio Frequency _____ _____ CF, BW _____ LR-HR _____	<b>Memory 6</b> Mode: _____ Operation Conditions/Radio Frequency _____ _____ CF, BW _____ LR-HR _____
<b>Memory 7</b> Mode: _____ Operation Conditions/Radio Frequency _____ _____ CF, BW _____ LR-HR _____	<b>Memory 8</b> Mode: _____ Operation Conditions/Radio Frequency _____ _____ CF, BW _____ LR-HR _____
<b>Memory 9</b> Mode: _____ Operation Conditions/Radio Frequency _____ _____ CF, BW _____ LR-HR _____	<b>Memory 10</b> Mode: _____ Operation Conditions/Radio Frequency _____ _____ CF, BW _____ LR-HR _____

## LIMITED 12 MONTH WARRANTY

MFJ Enterprises, Inc. warrants to the original owner of this product, if manufactured by MFJ Enterprises, Inc. and purchased from an authorized dealer or directly from MFJ Enterprises, Inc. to be free from defects in material and workmanship for a period of 12 months from date of purchase provided the following terms of this warranty are satisfied:

1. The purchaser must retain the dated proof-of-purchase (bill of sale, canceled check, credit card or money order receipt, etc.) describing the product to establish the validity of the warranty claim and submit the original or machine reproduction of such proof of purchase to MFJ Enterprises, Inc. at the time of warranty service. MFJ Enterprises, Inc. shall have the discretion to deny warranty without dated proof-of-purchase. Any evidence of alteration, erasure, or forgery shall be cause to void any and all warranty terms immediately.
  2. MFJ Enterprises, Inc. agrees to repair or replace at MFJ's option without charge to the original owner any defective product under warrantee provided the product is returned postage prepaid to MFJ Enterprises, Inc. with a personal check, cashiers check, or money order for **\$7.00** covering postage and handling.
  3. This warranty is **NOT** void for owners who attempt to repair defective units. Technical consultation is available by calling the Service Department at 662-323-0549 or the MFJ factory at 662-323-5869.
  4. This warranty does not apply to kits sold by or manufactured by MFJ Enterprises, Inc.
  5. Wired and tested PC board products are covered by this warranty provided **only the wired and tested PC board product is returned**. Wired and tested PC boards installed in the owner's cabinet or connected to switches, jacks, or cables, etc. sent to MFJ Enterprises, Inc. will be returned at the owner's expense unrepai red.
  6. Under no circumstances is MFJ Enterprises, Inc. liable for consequential damages to person or property by the use of any MFJ products.
  7. **Out-of-Warranty Service:** MFJ Enterprises, Inc. will repair any out-of-warranty product provided the unit is shipped prepaid. All repaired units will be shipped COD to the owner. Repair charges will be added to the COD fee unless other arrangements are made.
  8. This warranty is given in lieu of any other warranty expressed or implied.
  9. MFJ Enterprises, Inc. reserves the right to make changes or improvements in design or manufacture without incurring any obligation to install such changes upon any of the products previously manufactured.
  10. All MFJ products to be serviced in-warranty or out-of-warranty should be addressed to:  
  
**MFJ Enterprises, Inc.**  
**300 Industrial Park Road**  
**Starkville, Mississippi 39759 USA**
- and must be accompanied by a letter describing the problem in detail along with a copy of your dated proof-of-purchase.
11. This warranty gives you specific rights, and you may also have other rights which vary from state to state.