

ASSEMBLY AND INSTALLATION INSTRUCTIONS

SPECIFICATIONS			
MODEL	A148-20T	Boom Length, ft (m)	11 (3.4)
Frequency, MHz	144-148	Longest Element, in(cm)	40.6 (103)
No. Elements	20	Turning Radius, ft (m)	7.5 (2.3)
Forward Gain, dBd	11.1	Mast Size Range, in (cm)	1.25-2.0 (3.2-5.1)
Front to Back Ratio, dB	24	Wind Load, ft ² (m ²)	1.21 (0.11)
SWR 1.2:1 Typical		Weight, lb (kg)	7 (3.15)
2:1 Bandwidth MHz	≥4	Hardware	Stainless steel
Power Rating, Watts PEP	1000		
3 dB Beamwidth, Degrees			
E Plane	45		
H Plane	50		



The Electrical Specifications for all Cushcraft Amateur Antennas are derived from numerical analysis and measured data taken on our test range. Performance may vary due to the random variables associated with a specific application or installation.

LIMITED WARRANTY

Cushcraft Corporation, 48 Perimeter Road, Manchester, New Hampshire 03103, warrants to the original purchaser for one year from date of purchase that each Cushcraft antenna is free of defects in material or workmanship. If, in the judgement of Cushcraft, any such antenna is defective, then Cushcraft Corporation will, at its option, repair or replace the antenna at its expense within thirty days of the date the antenna is returned (at purchasers expense) to Cushcraft or one of its authorized representatives. This warranty is in lieu of all other expressed warranties, any implied warranty is limited in duration to one year. Cushcraft Corporation shall not be liable for any incidental or consequential damages which may result from a defect. Some states do not allow limitations on how long an implied warranty lasts or exclusions or limitations of incidental or consequential damages, so the above limitation and exclusion may not apply to you. This warranty gives you specific legal rights, and you may also have other rights which vary from state to state. This warranty does not extend to any products which have been subject the misuse, neglect, accident or improper installation. Any repairs or alterations outside of the Cushcraft factory will nullify this warranty.

A148-20T

2 METER VERTICAL & HORIZONTAL YAGI ANTENNA
144-148 MHz



48 Perimeter Road
Manchester, NH 03103
603-627-7877
FAX 603-627-1764



SPECIFICATIONS SUBJECT TO CHANGE WITHOUT NOTICE

WARNING

THIS ANTENNA IS AN ELECTRICAL CONDUCTOR. CONTACT WITH POWER LINES CAN RESULT IN DEATH, OR SERIOUS INJURY. DO NOT INSTALL THIS ANTENNA WHERE THERE IS ANY POSSIBILITY OF CONTACT WITH HIGH VOLTAGE OR ARC-OVER FROM POWER CABLES OR SERVICE DROPS TO BUILDINGS. THE ANTENNA, SUPPORTING MAST AND/OR TOWER MUST NOT BE CLOSE TO ANY POWER LINES DURING INSTALLATION, REMOVAL OR IN THE EVENT PART OF THE SYSTEM SHOULD ACCIDENTALLY FALL. FOLLOW THE GUIDELINES FOR ANTENNA INSTALLATIONS RECOMMENDED BY THE U.S. CONSUMER PRODUCT SAFETY COMMISSION AND LISTED IN THE ENCLOSED PAMPHLET.

Your Cushcraft VHF antenna is designed and manufactured to give top performance and trouble free service. The antenna will perform as specified if the instructions and suggestions are followed and care is used in assembly and installation. When checking the components received in your antenna package use the parts lists in each section. It is easiest to identify the various dimensions of tubing by separating them into groups of the same diameter and length. If you are unable to locate any tube or component, check the inside of all tubing. **IMPORTANT: save the weight label from the outside of the carton. Each antenna is weighed at the factory to verify the parts count. If you claim a missing part, you will be asked for the weight verification label.** There is a master parts list on page 2.

LOCATION

Location of the antenna is very important. Surrounding objects such as trees, power lines, other antennas, etc. will seriously reduce efficiency. To minimize the effects of surrounding objects, mount the antenna as high and in the clear as possible. If metal guy wires are used, they should be broken with strain insulators. **YOU MUST INSURE THAT NEITHER PEOPLE NOR PETS CAN COME IN CONTACT WITH YOUR ANTENNA WHILE IT IS IN OPERATION. DEADLY VOLTAGES AND CURRENTS MAY EXIST. ALSO, SINCE THE EFFECTS OF EXPOSURE TO RF ARE NOT FULLY UNDERSTOOD, LONG TERM EXPOSURE TO INTENSE RF FIELDS IS NOT RECOMMENDED. THERE IS A WARNING STICKER WHICH MUST BE ATTACHED TO THE BOOM AS SHOWN IN FIGURE E.**

Plan your installation carefully. If you use volunteer helpers be sure that they are qualified to assist you. Make certain that everyone involved understands that you are in charge and that they must follow your instructions. If you have any doubts at all employ a professional antenna installation company to install your antenna.

MOUNTING

The A148-20T mast mount bracket will take up to a 2" (5.1 cm) O.D. mast. A 1-1/4" (3.17 cm) television type tubing is satisfactory for any of the single beams. A good heavy-duty antenna rotator will provide the best service and longest life. Often it is desirable to mount several antennas on one mast. To keep possible interaction to minimum, place your antennas as far apart as you can. The A148-20T transmits and receives horizontal and vertical polarization. Vertical polarization is normally for FM and packet, while horizontal polarization is normally for SSB and CW.

SYSTEM GROUNDING

Direct grounding of the antenna, mast and tower is very important. This serves as protection from lightning strikes, static buildup and high voltage which is present in the radio equipment connected to the antenna. A good electrical connection should be made to one or more ground rods (or other extensive ground system) directly at the base of the tower or mast, using at least #10AWG ground wire and non-corrosive hardware. For details and safety standards, consult the National Electrical Code. You should also use a coaxial lightning arrester. Cushcraft offers several different models, such as LAC-1, LAC-2 and the LAC-4 series.

ASSEMBLY

Assemble your antenna by following the directions and illustrations in steps 1 through 4. After the antenna is completely assembled, verify dimensions and element spacings for accuracy. Then, return to the section below for final tuning.

TUNING PROCEDURE











The A148-20T does not normally require tuning after assembly. However, if you wish to check the VSWR before installation, please observe the following procedures. To prevent detuning the antenna, it should be tuned in place or at least 7 feet (2.1 m) above ground and clear of surrounding objects. Keep all metal obstructions such as guy wires and other antennas at least 7 feet (2.1 m) away since they will nullify any adjustment and degraded performance will result.

Run the coax cable from your transmitter to the area in which the antenna is going to be tested. The length of this cable is not critical. Connect a good quality VSWR bridge to the end of this cable. Connect a short length of cable [10 ft (3 m) or less] from the VSWR bridge to the antenna. Set the transmitter to your center operating frequency. When you read VSWR, be sure you move far enough away from the antenna so that your body does not effect the reading.

Measure the VSWR. If it is high, move the tuning strap by 1/4" (.6 cm) in one direction and check the VSWR. If the VSWR improves, then continue moving the tuning strap in the same direction. If the VSWR deteriorates then move the tuning strap in the opposite direction. Repeat this procedure until no further improvement can be made. There may be some interaction between the horizontal and vertical Reddi-Match settings. You have matched your antenna to 50 Ohms. Tighten all connections making sure to keep the Reddi-Match assembly parallel to the driven elements (V2, H2). Tape the feedlines to the boom and mast (figure F).

#3 - MAST MOUNT

Mount the antenna to your mast using the mounting plate (70) and the hardware provided per figure E. Refer to figure F for the mounting point. Tighten the U-bolts taking care not to crush the boom. See "MOUNTING" on page 1 concerning orientation of mast mount, elements and Reddi-Match.

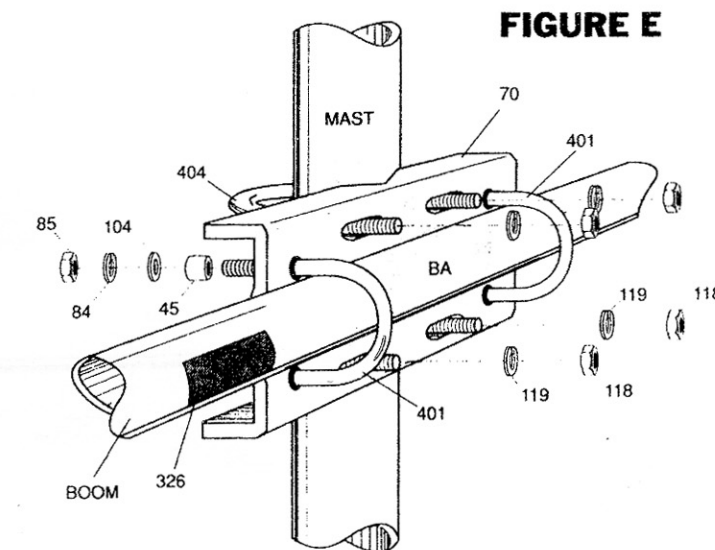

KEY	P/N	DISPLAY	DESC	SIZE	QTY
45	321045		ALUMINUM SPACER	1/2" x 1/2" (1.3 x 1.3 cm)	4
70	190070		FORMED MAST PLATE	4" x 6" (10.1 x 15.2 cm)	1
84	010084		SS LOCK WASHER	1/4" (.63 cm)	4
85	010085		SS HEX NUT	1/4" (.63 cm)	4
104	010104		SS FLAT WASHER	1/4" (.63 cm)	4
118	010118		SS HEX NUT	5/16" (.8 cm)	4
119	010119		SS LOCK WASHER	5/16" (.8 cm)	4
326	290326		DANGER LABEL		1
401	010401		SS U-BOLT	3" x 1-3/4" (7.6 x 4.4 cm)	2
404	010404		SS U-BOLT	3-1/4" x 2-7/16" (8.3 x 6.2 cm)	2

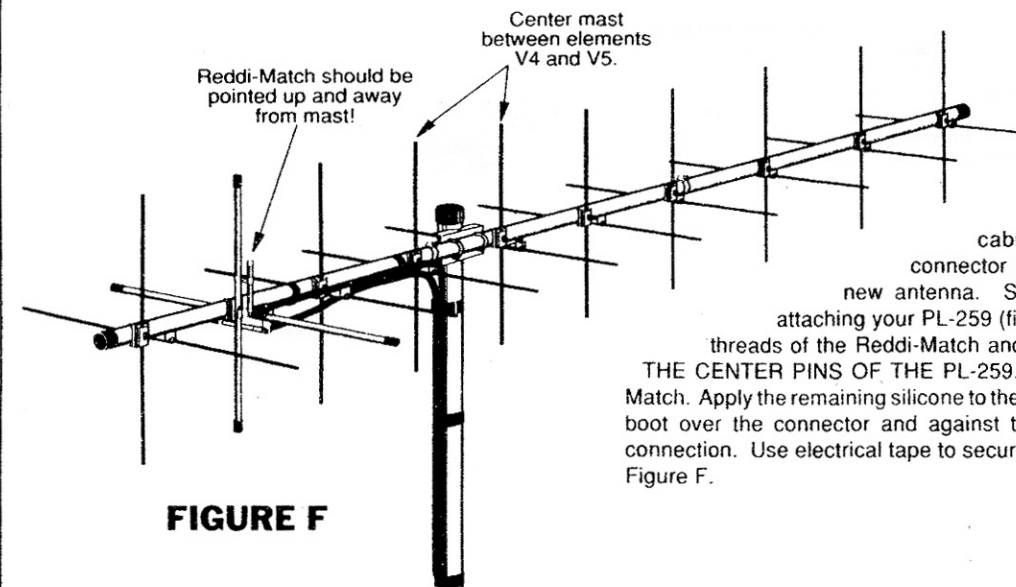

#4 - FEEDLINE

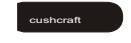

This antenna is designed for use with 50 Ohm coaxial cable terminated with a PL-259 connector. Any length of feedline can be used with your A148-20T. The shortest length of cable will have the least loss. Two connector boots are included for use with your new antenna. Slide the boot over the cable before attaching your PL-259 (figure F). Spread silicone on the outer threads of the Reddi-Match and PL-259 connector. **DO NOT COAT THE CENTER PINS OF THE PL-259.** Attach the connector to the Reddi-Match. Apply the remaining silicone to the outside of the connector. Slip the vinyl boot over the connector and against the mast bracket for a weather tight connection. Use electrical tape to secure coax to boom and mast as shown in Figure F.

KEY	P/N	DISPLAY	DESC	SIZE	QTY
115	050115		CONN BOOT		2
116	240116		SILICONE PACKAGE		2



#2 - ELEMENT ASSEMBLY

Assemble the two driven element tubes (H2,V2) and connector brackets (23) to the boom at the positions shown in figure B using the hardware shown in figure C. Note that the connectors point toward the center of the boom. Assemble the Reddi-Match components RR, PT, RT and 251. Set them aside for the moment. Loosely attach the Reddi-Match straps (921) to the driven elements (H2,V2) as shown. Slide the Reddi-Match assembly through the Reddi-Match straps and secure the rod (RR) to the connector. Use washer (41) and nut (11). Next, slide the poly tube (PT) to the flattened end of the rod (Figure C-2). Set the dimensions shown in figure C and tighten the hardware. Note: Reddi-Match settings are different for H2 and V2.

Two sets of elements are provided with the antenna. Each set is mounted 90 degrees to the other. Lengths are shown in Table A. Using Figure B for positioning, attach the elements using the hardware shown in Figure D. Element lengths within 1/16" (.16 cm) of the stated length are acceptable. Check elements again to assure that they are in the correct position and tighten the hardware.

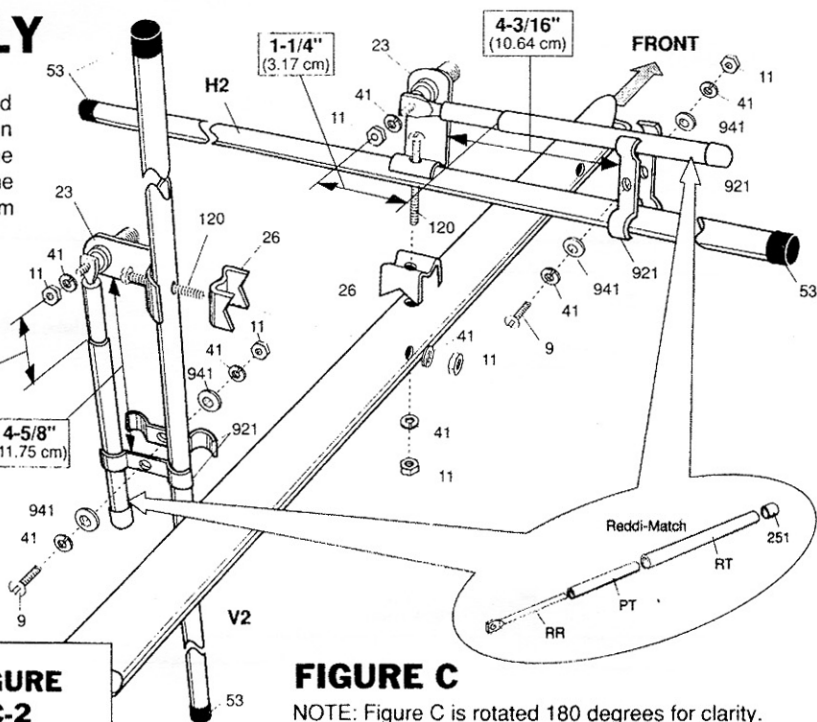
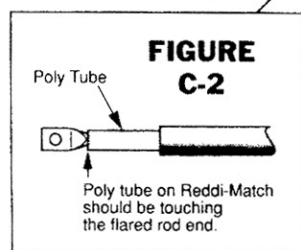

FIGURE C

NOTE: Figure C is rotated 180 degrees for clarity.

KEY	P/N	DISPLAY	DESC	SIZE	QTY
9	010009		SS MACHINE SCREW	8-32 x 5/8" (1.6 cm)	2
11	010011		SS HEX NUT	8-32	24
23	190023		CONNECTOR BRACKET		2
26	190026		ALUMINUM BRACKET	7/8" (2.2 cm)	20
28	190028		ALUMINUM HALF WASHER		18
41	011941		SS LOCK WASHER	#8	26
53	050053		PLASTIC CAP	1/2" (1.3 cm)	4
120	010120		SS MACHINE SCREW	8-32 x 2" (5.1 cm)	6
231	010231		SS MACHINE SCREW	8-32 x 1-3/4" (4.4 cm)	14
251	050251		PLASTIC CAP	3/8" (1 cm)	2
921	200921		TUNING STRAP		4
941	360941		FLAT WASHER	#8	4

TABLE A (Elements)		
H1, V1	40-5/8" (103 cm)	2
H2, V2	39-1/4" x 1/2" (99.7 x 1.3 cm)	2
H3, V3	37-3/4" (95.9 cm)	2
H4, V4	36-1/2" (92.7 cm)	2
H5, V5	35-3/8" (89.9 cm)	2
H6, V6	34-3/8" (87.3 cm)	2
H7, V7	33-3/4" (85.7 cm)	2
H8, H9, V8, V9	32-3/4" (83.2 cm)	4
H10, V10	31-1/8" (79.1 cm)	2

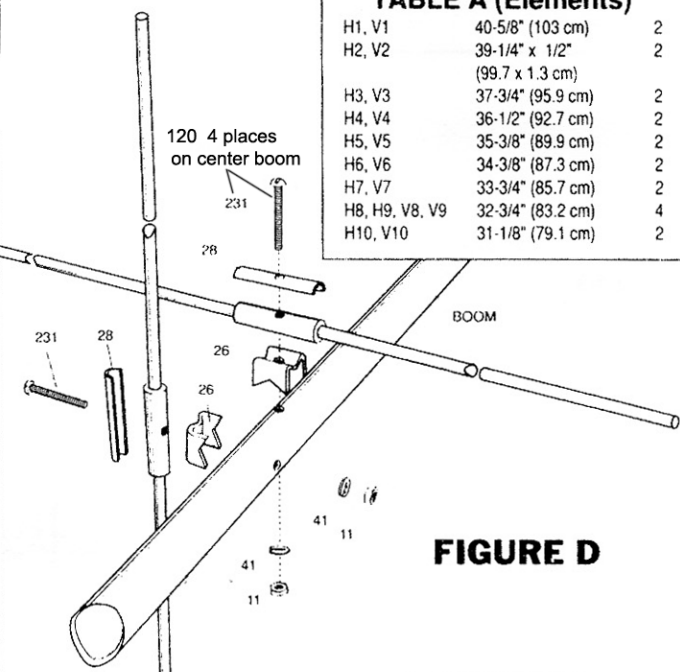

FIGURE D

KEY	P/N	DISPLAY	DESC	SIZE	QTY
H2/V2			ALUMINUM TUBE	1/2" x 39-1/4" (1.3 x 99.7 cm)	2
PT			POLY TUBE	3/16" x 4-1/2" (.5 x 11.4 cm)	2
RR			REDDI-MATCH ROD	3/16" x 4" (.5 x 10.2 cm)	2
RT			ALUMINUM TUBE	3/8" x 6-1/2" (.9 x 16.5 cm)	2

MASTER PARTS LIST

KEY	PART #	DESCRIPTION	QUANTITY	KEY	PART #	DESCRIPTION	QUANTITY
9	010009	8-32 x 5/8" (1.6 cm) stainless steel machine screw	2	401	010401	3" x 1-3/4" (7.6 x 4.4 cm) stainless steel U-bolt	2
11	010011	8-32 stainless steel hex nut	24	404	010404	3-1/4 x 2-7/16 (8.3 x 6.2 cm) stainless steel U-bolt	2
23	190023	Connector bracket	2	410	030410	1" (2.5 cm) stainless steel worm clamp	2
26	190026	7/8" x 1-1/2" (2.2 x 3.8 cm) mounting bracket	20	921	200921	Reddi-Match clamp	4
28	190028	Aluminum half washer	18	941	360941	#8 aluminum flat washer	4
41	011941	#8 stainless steel lock washer	26				
45	321045	1/2" x 1/2" (1.3 x 1.3 cm) aluminum spacer	4	BA		1" x 48" (2.5 x 122 cm) aluminum tubing slotted both ends	1
				BB		7/8" x 50" (2.2 x 127 cm) aluminum tubing	1
53	050053	1/2" (1.3 cm) black plastic cap	4	BC		7/8" x 50" (2.2 x 127 cm) aluminum tubing	1
61	050061	7/8" (2.2 cm) black plastic cap	2	H1, V1		40-5/8" (103.2 cm) aluminum rod	2
70	190070	4" x 6" (10.2 x 15.2 cm) formed mast plate	1	H2, V2		39-1/4" x 1/2" (99.7 x 1.3 cm) tubing drilled in center	2
84	010084	1/4" (.63 cm) stainless steel split lock washer	4	H3, V3		37-3/4" (95.9 cm) aluminum rod	2
85	010085	1/4" (.63 cm) stainless steel hex nut	4	H4, V4		36-1/2" (92.7 cm) aluminum rod	2
104	010104	1/4" (.63 cm) stainless steel flat washer	4	H5, V5		35-3/8" (89.9 cm) aluminum rod	2
115	050115	Connector boot	2	H6, V6		34-3/8" (87.3 cm) aluminum rod	2
116	240116	Silicone package	2	H7, V7		33-3/4" (85.7 cm) aluminum rod	2
118	010118	5/16" (.8 cm) stainless steel hex nut	4	H8, H9, V8, V9		32-3/4" (83.2 cm) aluminum rod	4
				H10, V10		31-1/8" (79.1 cm) aluminum rod	2
119	010119	5/16" (.8 cm) stainless lock washer	4	PT		3/16" x 4-1/2" (.48 x 11.4 cm) poly tube	2
120	010120	8-32 x 2" (5.1 cm) stainless steel machine screw	6	RR		3/16" x 4" (.48 x 10.2 cm) Reddi Match rod	2
231	010231	8-32 x 1-3/4" (4.4 cm) stainless steel machine screw	14	RT		3/8" x 6-1/2" (.9 x 16.5 cm) aluminum tube	2
251	050251	3/8" (1 cm) white plastic cap	2				
326	290326	Danger label	1				

INSTALLATION RECOMMENDATIONS & OPERATING TIPS

(for dual band and VHF beam antennas)

These Installation Recommendations and Operating Tips are offered to help you enjoy the use of your antenna to the fullest. In our estimation, your system will work "optimally", while achieving the longest service life if they are followed.

- Vertically and horizontally stack your antennas a minimum of 1/2 the boom length of the antenna operating at the higher frequency.
- Vertically and horizontally space your antenna a minimum of ten (10) feet from any other surrounding metal.
- When considering height above ground, achieving "line sight" is most desirable for optimal performance. It is recommended that you achieve "line sight" and be at least ten (10) feet above ground.
- Do not use vinyl tape on SO-239 or PL-259 connectors.

NOTE: Please retain the invoice from your dealer for the purchase of your antenna as "Proof of Purchase" as you may be asked for a copy if you make a warranty claim.

#1 - BOOM ASSEMBLY

Assemble the boom as shown in figure A. Make a mark 11" (27.9 cm) in from the end of the BB and 5" (12.7 cm) from the end of the BC tube as shown. Be sure to mark the correct end of each tube by referring to the dimensions of the hole locations. Slide worm clamps (410) onto the slotted ends of tube BA. Insert the BB and BC tubes up to the marks you made. Align the element holes on all three sections and tighten the worm clamps. Push the end caps (61) onto the ends of the boom.





KEY	P/N	DISPLAY	DESC	SIZE	QTY
BA			ALUM TUBE	1" x 48" (2.5 x 122 cm)	1
BB			ALUM TUBE	7/8" x 50" (2.2 x 127 cm)	1
BC			ALUM TUBE	7/8" x 50" (2.2 x 127 cm)	1
61	050061		PLASTIC CAP	7/8" (2.2 cm)	2
410	030410		WORM CLAMP	1" (2.5 cm)	2

FIGURE A

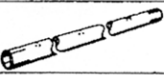
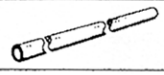
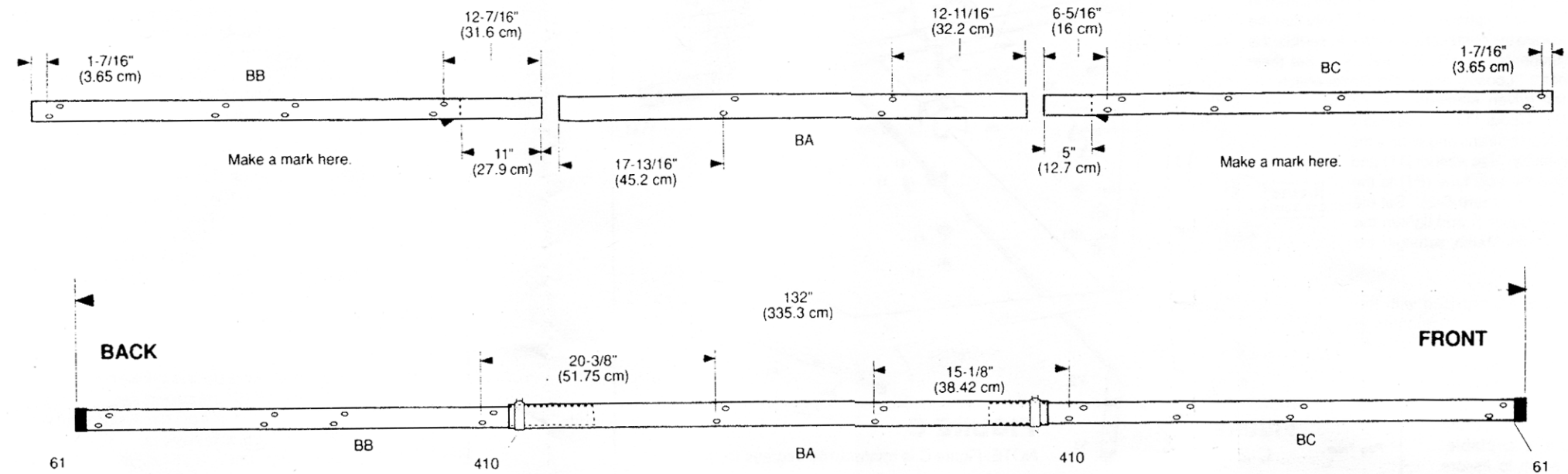

FIGURE B

