

④ Enlarged Section  
3" 1'-0"

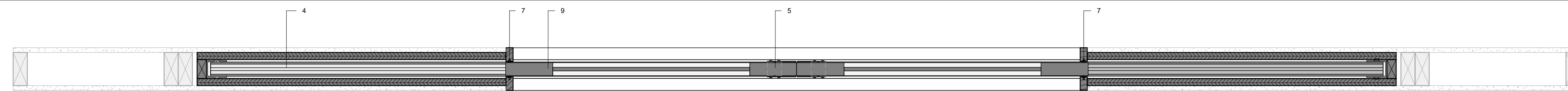

⑤ Pocket Door Assembly - Horizontal Section  
1 1/2" 1'-0"

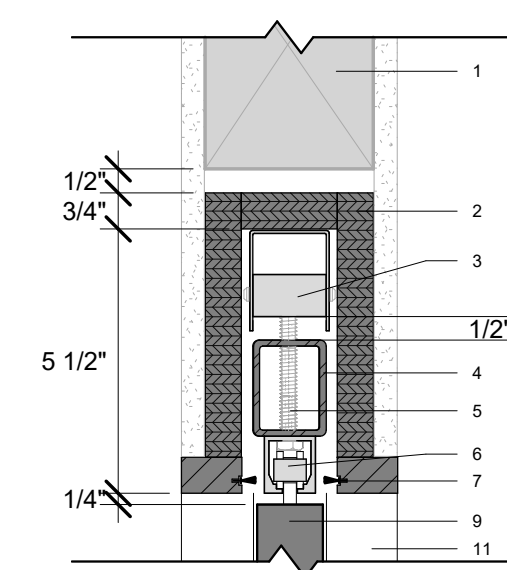
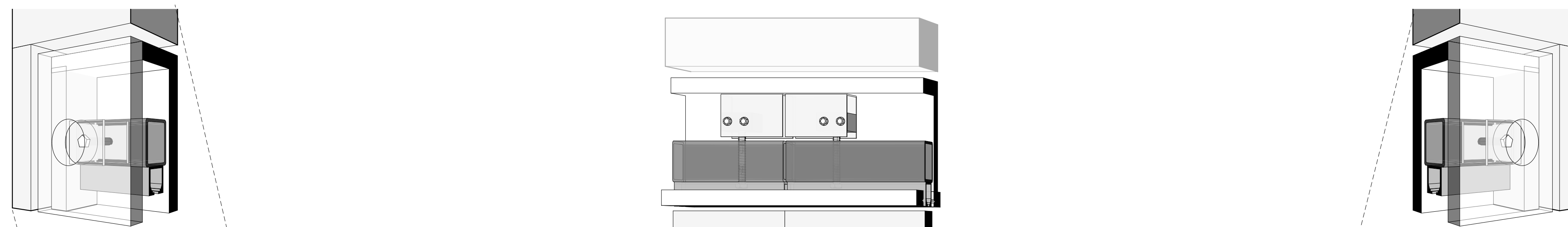

⑦ PPDS Section Detail  
3" 1'-0"

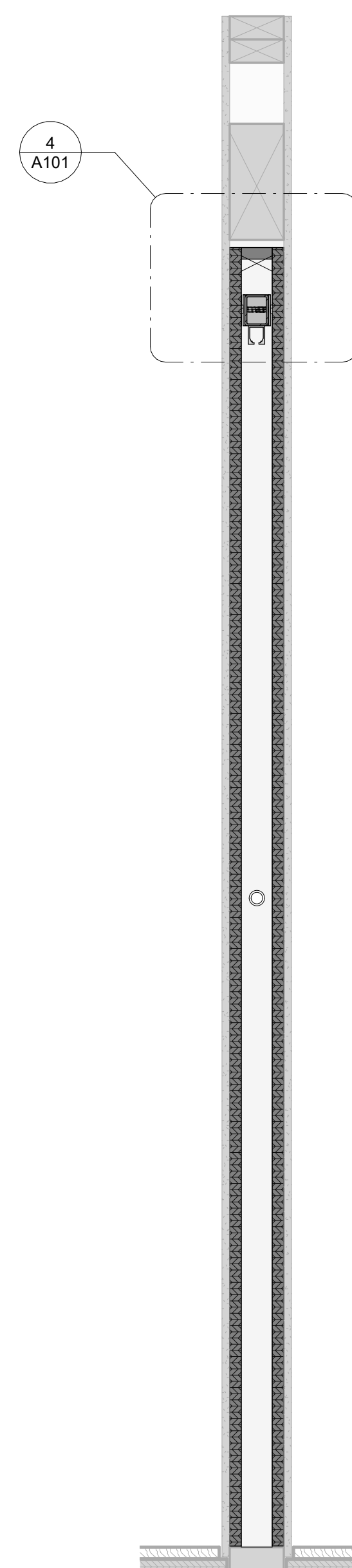

③ Section  
1 1/2" 1'-0"

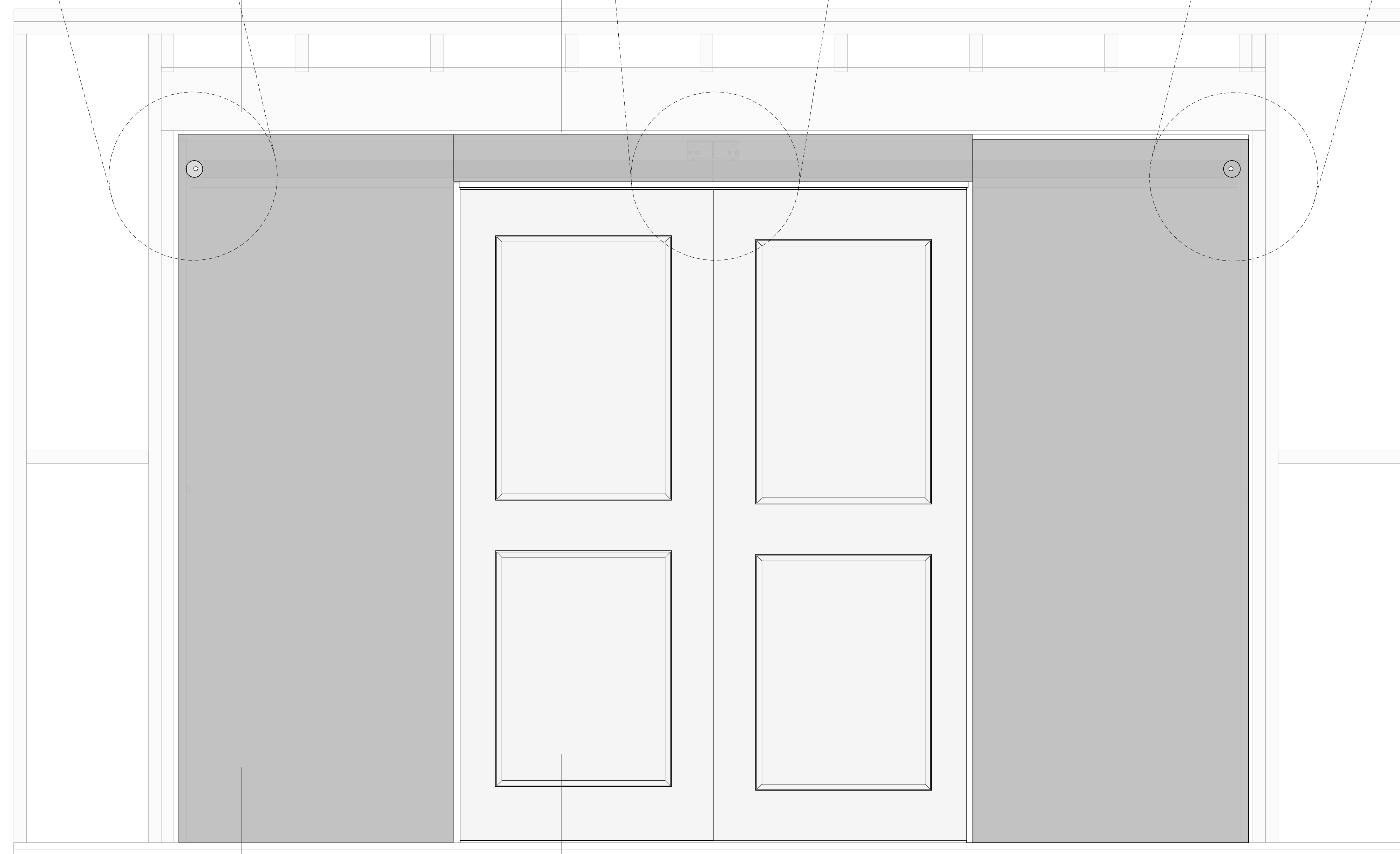

② Pocket Door Assembly Elevation  
1 1/2" 1'-0"

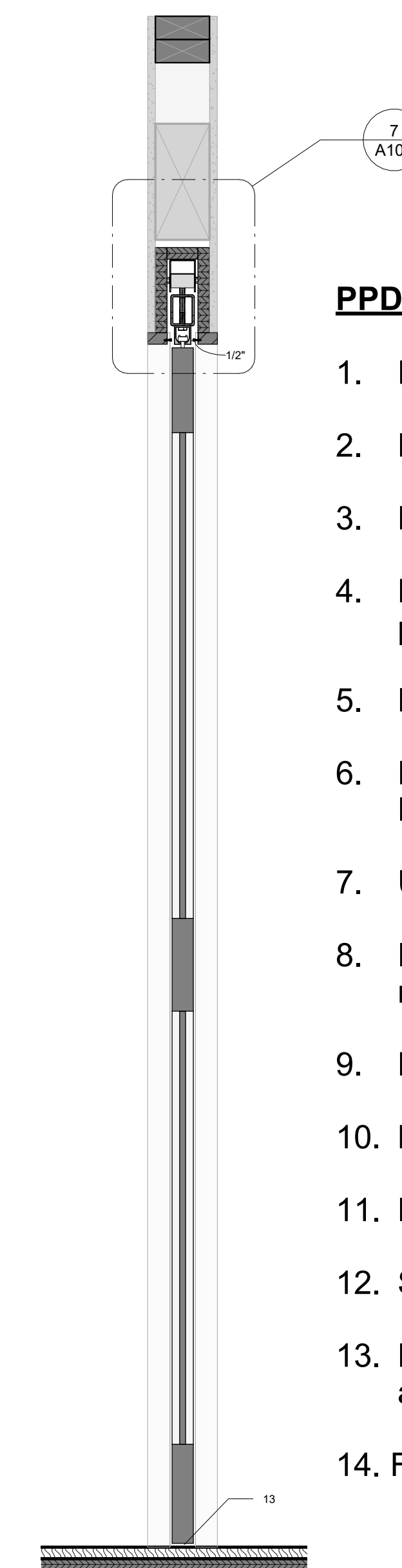

⑥ Section 2  
1 1/2" 1'-0"

**PPDS Assembly Notes - 2x4 Wall System**

1. Header (By Others)
2. Plywood nailers.
3. PPDS adjustable support bracket.
4. PPDS bar. Bar to be adjusted to level position using adjustment bolt.
5. PPDS vertical adjustment bolt.
6. Hawa Junior 40/B trolley hanger assembly. Refer to manufacturers instructions.
7. Ultrafab Kerf Mounted Pile Weatherstripping.
8. Hawa Junior 40/B door leaf insert. Refer to manufacturers instructions.
9. Door kerf. 1-3/8".
10. Bumper.
11. Door Jamb.
12. Sub-floor.
13. Recommended door clearance to be 1/4" above finished floor height.
14. Finished floor.

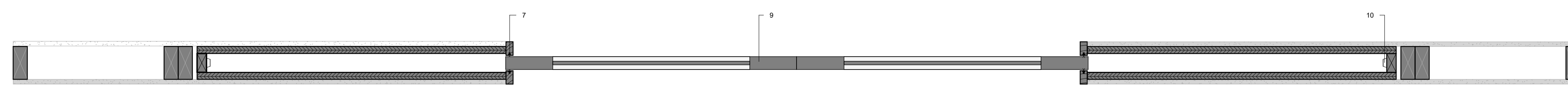

① Pocket Door Assembly - Horizontal Section  
1 1/2" 1'-0"

Pre-Manufactured Pocket Door Frame  
2" x 4" Wall Construction - Pocket Door Pair  
**petersonpocketdoor**<sup>TM</sup>  
**SYSTEMS**