

Motor guide | February 2014

Low voltage motors

Motor guide

Power and productivity
for a better world™



We provide motors and generators, services and expertise to save energy and improve customers' processes over the total lifecycle of our products, and beyond.



Motor guide – basic technical information about low voltage standard motors



Motors and Generators

© Copyright 2014 ABB. All rights reserved. Specifications subject to change without

notice. ISBN 952-91-0728-5

Third edition 2014

Motor guide

Contents

8	1.	Introduction
9	1.1	About ABB
10	1.2	IEC low voltage motor ranges
10	1.2.1	Standard induction motors
10	1.2.2	Motors for explosive atmospheres
11	1.2.3	Frequency-controlled motors
13	1.3	Complete product offering
16	2.	Energy saving and the environment
17	2.1	Energy efficiency standards
17	2.1.1	IEC efficiency classes
18	2.1.2	Energy efficiency schemes
19	2.1.3	Efficiency testing standards
20	2.2	Life cycle approach and energy appraisal
20	2.2.1	Energy appraisal
21	2.3	Environmental management within ABB
21	2.3.1	ISO 14001
21	2.3.2	Hazardous substances
21	2.3.3	Materials selection
24	3.	Standards
25	3.1	Definitions
26	3.2	Standards tables
26	3.2.1	The main standards for low voltage motors
27	3.2.2	The main EU directives for motors
27	3.2.3	Efficiency determination for motors outside Europe
28	3.3	Direction of rotation
29	3.4	Cooling
31	3.5	Degrees of protection: IP code/IK code
32	3.6	Standard voltage ranges
33	3.7	Voltage and frequency
34	3.8	Tolerance
35	3.9	Mounting arrangements
36	3.10	Dimensions
38	3.11	Output power and frame size ratio

42	4.	Electrical design – induction motors
43	4.1	Induction motor
44	4.2	Insulation
45	4.3	Thermistors
45	4.4	Ambient temperatures and high altitudes
46	4.5	Starting methods
46	4.5.1	Direct-on-line (DOL) starting
46	4.5.2	Star-delta starting
47	4.5.3	Soft starters
48	4.5.4	Starting with a variable speed drive
49	4.6	Starting limitations
56	4.7	Duty types
60	4.8	Up-rating
61	4.9	Efficiency and types of losses
62	4.10	Power factor
65	4.11	Air flow and air speed
66	4.12	Connection diagram
68	5.	Mechanical design
69	5.1	Motor construction
70	5.2	Frame constructions
71	5.3	Terminal boxes
73	5.4	Bearings
74	5.5	Drain holes and humidity
75	5.6	External radial and axial forces of the motor
75	5.7	Balancing
76	5.8	Vibration
77	5.9	Surface treatment
80	6.	Noise
81	6.1	Sound pressure level and sound power level
82	6.2	Weighting filters
83	6.3	Octave bands
84	6.4	Additional sound sources
85	6.5	Noise components of a motor
87	6.6	Airborne and structure-borne noise
88	6.7	Sound pressure levels
90	7.	Installation and maintenance
91	7.1	Delivery acceptance
91	7.2	Insulation resistance check
92	7.3	Torque on terminals

92	7.4	Operation
93	7.5	Handling
94	7.6	Foundations
95	7.7	Coupling alignment
96	7.7.1	Mounting pulleys and coupling halves
97	7.8	Slide rails
98	7.9	Mounting bearings
98	7.10	Lubrication
99	7.11	Fuse rating
100	8.	The SI system
101	8.1	Quantities and units
102	8.2	Prefixes
103	8.3	Conversion factors
108	9.	Ordering
109	9.1	Selecting a motor
111	9.2	Online tools
111	9.2.1	Optimizer
112	9.2.2	DriveSize and MotSize
112	9.3	Loading (kW)
113	9.4	Speed
113	9.5	Starting the motor
114	9.6	Operating environment
114	9.7	Ordering and order check list
116	10.	Variable speed drives
117	10.1	Types of drives
118	10.2	Pulse Width Modulation
118	10.3	Dimensioning the drive
120	10.4	Loadability (torque)
121	10.4.1	Improving loadability
122	10.5	Insulation level
122	10.6	Earthing
123	10.7	Operating at maximum speed
124	10.8	Balancing
124	10.9	Critical speeds
124	10.10	Shaft seals
126	10.11	Low speed operation

1. Introduction

1.	Introduction	8
1.1	About ABB	9
1.2	IEC low voltage motor ranges	10
1.2.1	Standard induction motors	10
1.2.2	Motors for explosive atmospheres	10
1.2.3	Frequency-controlled motors	11
1.3	Complete product offering	13

Introduction

This guide provides basic information about IEC low voltage motors. In this context, low voltage refers to motors that operate at voltages less than 1 000 V and produce a maximum power of 1 000 kW. The reference values provided in this guide apply specifically to ABB's Process performance motor range.

The designation IEC means that the motors conform to standards developed by the International Electrotechnical Commission. For example, IEC standardizes the frame size of motors; in the case of Process performance motors, there are frame sizes starting from IEC frame 56 in the aluminum range up to 450 (millimeters from shaft to base) in the cast iron motor range. More recently, IEC standards have specified how motors should be classified into energy efficiency classes.

Introduction

1.1 About ABB

ABB (www.abb.com) is a leader in power and automation technologies that enable utility and industry customers to improve their performance while lowering environmental impact. The ABB Group of companies operates in around 100 countries and employs about 145,000 people. ABB manages its business based on a divisional structure, with five divisions: Power Products, Power Systems, Discrete Automation and Motion, Low Voltage Products and Process Automation.

At ABB, motors are manufactured and marketed by the business unit Motors and Generators, which is part of ABB's Discrete Automation and Motion division. The Discrete Automation and Motion division offers a wide range of products and services including drives, motors, generators, power electronics systems, rectifiers, power quality and power protection products, converters, photovoltaic inverters, programmable logic controllers (PLCs), and robots. These products help customers to improve productivity, save energy, improve quality and generate energy.

The business unit Motors and Generators manufactures low, medium and high voltage motors and generators, and mechanical power transmission products. ABB products are backed up by an extensive portfolio of services and a high level expertise in a wide variety of motor applications.

1.2 IEC low voltage motor ranges

In this overview, motors are classified primarily according to their fundamental physical differences, and secondarily, according to their purpose of use. Accordingly, we divide motors into two ranges of induction motors, four types of motors for explosive atmospheres, frequency controlled motors, most notable of which are synchronous motors, and special application motors. The last category of motors include, for example, marine motors, brake motors, and smoke extraction motors, which are based on the basic induction motor but have modifications that vary according to the purpose of use. Their features are not further described here.

1.2.1 Standard induction motors

ABB offers two types of low voltage induction motor series: Process performance and General performance motors. The first are the most commonly chosen induction motors for demanding industrial uses and cover frame sizes 63 – 450, or 0.12 – 1 000 kW. Furthermore, these motors exist in three energy efficiency classes: IE2, IE3, and IE4.

General performance motors form the basic motor series in the IE2 efficiency class, with less optional features than for Process performance motors, but available off-the-shelf worldwide. These motors come in frame sizes 56 – 355, corresponding to 0.06 – 355 kW.

Both series include cast iron and aluminum subranges.

1.2.2 Motors for explosive atmospheres

ABB's motors for explosive atmospheres, or so called Ex-motors, comply fully with the ATEX directive 94/9/EC, which sets forth the mandatory duties and responsibilities of the manufacturer of products installed in the European Economic area. In addition to ATEX certification, the global IECEx certificate is available for most ABB Ex-products. National certificates like CQST for China, CU-TR required by the customs union of Russia, Belarus and Kazakhstan, or other, can also be ordered for a wide selection of products. Please refer to the product catalog and variant code section for availability of different certificates.

Equipment for explosive atmospheres is grouped according to the location above or underground and type of explosive atmosphere (gas/dust) it is intended for. Equipment protection levels (EPLs) designate the likelihood of the equipment becoming a source of ignition and distinguish between an explosive gas atmosphere, a dust atmosphere, and the explosive atmospheres in mines susceptible to fire damp. Further, explosive atmospheres are divided into zones according to the

risk posed by explosive gas (G) or dust (D). The table below shows the correlation between equipment groups, EPLs, zones, and protection types used in motors. In addition, the required temperature class of the equipment must be taken in consideration; it depends on the ignition temperature of the flammable gas or dust present in the environment, as well as the subgroup of the gas or dust.

Standard		Installation		ATEX Directive		Main motor
IEC 60079-0		Zone acc. to		94/9/EC		protection types
EN 60079-0		IEC 60079-10-x				
		EN 60079-10-x				
Group	Protection		Zones	Equipment group	Equipment category	
	EPL	level				
I (Mines)	Ma	very high	NA	I (Mines)	M1	NA
	Mb	high			M2	
II (Gas)	Ga	very high	0	II (Surface)	1G	NA
	Gb	high	1		2G	Ex d/Ex de Ex p, Ex e
	Gc	enhanced	2		3G	Ex nA
III (Dust)	Da	very high	20		1D	NA
	Db	high	21		2D	Ex tb IP 65
	Dc	enhanced	22		3D	Ex tc IP 65/IP 55

Motors for explosive atmospheres are available from frame size 71 to 450 (80 to 450 in flame proof design) or from 0.25 kW up to 1000 kW.

1.2.3 Frequency controlled motors

Frequency controlled motors refer to motor series that are invariably used together with a frequency converter. This category of motors includes two types of synchronous motors, namely synchronous reluctance motors and permanent magnet motors, as well as roller table motors, high speed motors, and servomotors.

ABB provides two synchronous reluctance motor series: High-output and IE4 synchronous reluctance motors. The High output motors are best suited for applications requiring a high power to size ratio and extend from frame size 90 to 315, or 1.1 to 350 kW, with a minimum efficiency level of IE2. As the name suggests, IE4 synchronous reluctance motors provide the highest efficiency available and range from frame size 160 to 315, corresponding to 7.5 to 315 kW.

Permanent magnet motors are suited for applications requiring high torque density and operating at a maximum speed of 600 r/min at 400 V. Permanent magnet motors are provided either with self-cooling or with separate cooling. Frame sizes in the low voltage area range from 280 to 450 and a maximum of 1000 kW (with a 690 V voltage).

The high speed range covers standard motors in the 3600 – 5100 rpm speed area. In addition, custom motors for specific applications have been made all the way up to 60 000 rpm.

Low voltage servomotors include two series of High dynamic power (HDP) motors: IP54 and IP23. These motors provide an extremely good power to size ratio through low moment of inertia and high pulse torque and are best suited for rough conditions where high overloads may occur. The motors range from frame size 100 to 250, or 2 to 750 kW.

1.3 Complete product offering



Standard induction motors

- Process performance motors
- General performance motors



Motors for explosive atmospheres

- Flameproof motors
- Increased safety motors
- Non-sparking motors
- Dust ignition protection motors



Frequency controlled motors

- Synchronous reluctance motors
- Permanent magnet motors
- High speed motors
- HDP AC servomotors



Special application motors

- Marine motors
- Water cooled motors
- Brake motors
- Motors for high ambient temperatures
- Smoke extraction motors
- Single phase motors
- Traction motors

IEC low voltage motors product offering

2. Energy saving and the environment

2.	Energy saving and the environment	16
2.1	Energy efficiency standards	17
2.1.1	IEC efficiency classes	17
2.1.2	Energy efficiency schemes	18
2.1.3	Efficiency testing standards	19
2.2	Life cycle approach and energy appraisal	20
2.2.1	Energy appraisal	20
2.3	Environmental management within ABB	21
2.3.1	ISO 14001	21
2.3.2	Hazardous substances	21
2.3.3	Materials selection	21

Energy saving and the environment

The world industry and commerce are facing an energy challenge. Global demand for energy is rising steadily. At the same time, pressures to reduce energy consumption, to lower carbon dioxide (CO₂) emissions and provide secure power supplies are becoming ever stronger.

Efficient motors help cut energy costs and limit carbon dioxide emissions. It has been estimated that electric motors account for about 65 per cent of the electricity consumed in industrial applications, so the energy-saving potential among industries is enormous. Energy consumption is dependent on the kW rating of the motor, loading, and the hours run. High-efficiency motors as such can play a significant part in reducing CO₂ emissions.

ABB is a long-standing advocate of the need for high efficiency in motors and its policy is to offer high-efficiency motors as standard, available directly from stock. Rather than concentrating solely on efficiency, however, we take a lifecycle approach and seek to minimize the costs associated with our products over their entire lifetime.

Energy saving and the environment

2.1 Energy efficiency standards

The International Electrotechnical Commission (IEC) has introduced standards relating to energy efficient motors. **IEC 60034-2-1** specifies rules concerning efficiency testing methods and IEC 60034-30 defines efficiency classes for a wide range of electric motors connected direct on line. **IEC 60034-30-1** (which becomes valid in 2014) takes a step further in widening the scope of motors subject to efficiency classes and introduces the IE4 class. VSD-driven motors are out of the scope of this standard and will be dealt with in a standard of its own.

2.1.1 IEC efficiency classes

IEC 60034-30-1 defines four IE (International Efficiency) classes for all electric motors that are rated for sinusoidal voltage.

Standard efficiency	IE1
High efficiency	IE2
Premium efficiency	IE3
Super premium efficiency	IE4

The scope of this standard is wider than that of IEC 60034-30. IEC 60034-30-1 covers not only standard motors up to eight poles but marine motors, brake motors and motors for explosive atmospheres. Excluded are, among a few other exceptions, power-drive systems and motors completely integrated to an application or frequency converter, so that they cannot be tested independently.

The efficiency levels defined in IEC 60034-30-1 are based on test methods specified in IEC 60034-2-1: 2007 with low uncertainty for IE2 and IE3. The methods in IEC 60034-2-1 determine efficiency values more accurately than the methods previously used. The lowest efficiency value and the associated IE classification are shown on the motor's rating plate (when applicable).

The following figure shows the correlation between required efficiency and output for the four efficiency classes.

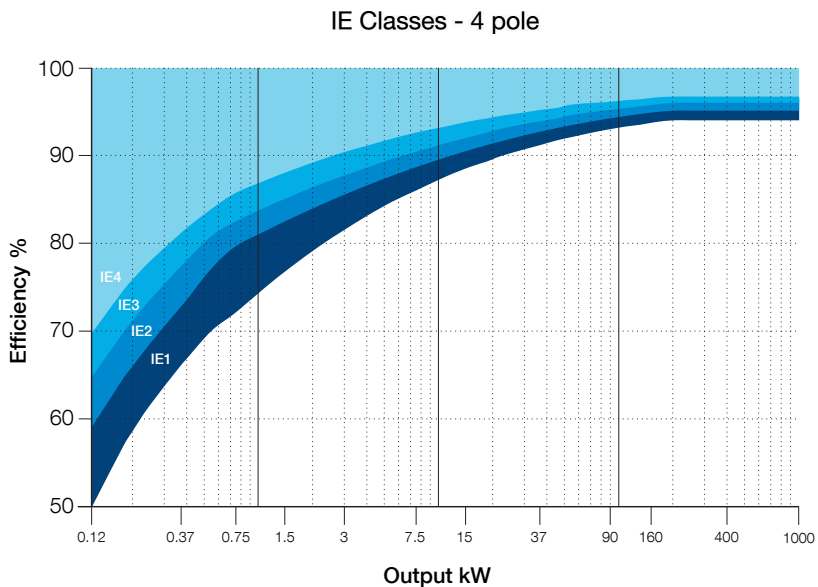

Figure 2.1 IE efficiency classes for 4-pole motors at 50 Hz

2.1.2 Energy efficiency schemes

Though the IEC efficiency standards are internationally relevant, differences in implementation still exist. The following table shows the correlation between the IE efficiency classes and regional efficiency schemes in different parts of the world. Notice that IE1, 'standard efficiency', has become substandard in all the regions mentioned, and there are no imperative timelines yet for establishing IE4 regionally.

IEC 60034-30-1	IE2 - high efficiency	IE3 - premium efficiency
Australian MEPS	Required level	Adoption as standard under discussion
Brazilian Labeling Program, PBE	Required level; scope of motors was extended in Dec. 2012	-
Canada Energy Efficiency Act	Required level for 201-500 HP foot-mounted and all 1-500 HP footless and 8-pole motors	Required level for 1-200 HP foot-mounted motors
China Energy Label	Required level	-
EU MEPS	'IE2 high efficiency', required level	'IE3 premium efficiency', required by 2015 for 7.5 - 375 kW motors
Korean MEPS	Required level for 2-8 pole motors	Required for 2-8 pole motors by 2017
Mexican MEPS	Required level identical to IE2	Expected to follow EISA IE3 in the future
USA, EISA2007	'Energy efficient', required level for 201-500 HP 2-6 pole and 1-500 HP 8-pole motors	NEMA premium efficiency required for 1-200 HP, 2-6 pole motors

Table 2.1 Correlation between IEC and regional efficiency schemes

The IEC60034-30-1 only defines the requirements for efficiency classes and aims to create a basis for international consistency. It does not specify which motors must be supplied with which efficiency level. This is left to the respective regional legislation. Within the European Union, Motor Regulation EC 640/2009 is the default legislative requirement and sets the minimum efficiency levels for placing motors on the market or commissioning them.

2.1.3 Efficiency testing standards

In addition to IEC 60034-2-1 (EU), there are two other major testing standards, namely IEEE 112-2004 (USA), and CSA 390-10 (Canada). The main difference is that IEEE 112 determines total motor losses with a direct method and therefore gives the lowest efficiency values.

In addition, the Brazilian standard NBR 17094-1 deviates in the way the motor's reference temperature is determined. NBR uses frame temperature, whereas other standards use winding temperature as the reference temperature.

IEC 60034-2: 1996 (the old IEC method) specifies the indirect method for defining motor efficiency. With this method, additional losses are assumed at 0.5 per cent of the motor's input power, which is lower than real losses for small motors and therefore gives higher efficiency values than the current method.

2.2 Life cycle approach and energy appraisal

To achieve the best return on investment, users of production equipment need to apply a life cycle approach when considering investing in major equipment. The life cycle cost (LCC) is the total cost for purchasing, installing, operating, maintaining and disposing of an item of machinery.

It is necessary to raise awareness of the financial benefits of energy efficiency. Payback times of an item of machinery can be extremely short but many businesses still focus on the purchase price when buying new equipment, instead of considering running costs over the lifespan.

The purchase price of an electric motor and drive, for instance, is just 1-3 per cent of what the owner will spend on energy to run the equipment over its lifetime. The significance of a variable speed drive in efficiency considerations is in its quality to control the speed of the motor and therefore ensure that it runs no faster than actually needed.

LCC should be calculated not only on new installations but also existing ones. Existing systems provide much greater scope for efficiency improvements than new installations. The volume of systems in use exceeds the volume of annual new installations many times over. Additionally, many existing installations can offer considerable scope for improvement if the duty has changed since the system was first installed.

2.2.1 Energy appraisal

ABB has devised a simple and methodical energy appraisal process that presents the energy saving potential of selected applications to the end users. The starting point for an energy appraisal is to identify applications where energy can be saved immediately.

Energy appraisals are most suitable for processes with variable torque applications that obey the cube law, run continuously, and where the flow is controlled by a mechanical means such as valves or dampers. This is where the savings from installing a variable speed drive typically are the most significant compared to the initial investment cost.

2.3 Environmental management within ABB

2.3.1 ISO 14001

To ensure continual improvement, ABB requires all manufacturing and service facilities to implement environmental management systems according to the ISO 14001 standard. For non-manufacturing sites we have implemented and adapted an environmental management system to ensure management of environmental aspects and continual performance improvement. Almost all of these approximately 360 sites and offices work in compliance with the requirements of the standard and our environmental management program now covers operations in 59 countries. It is ABB's aim to further advance the adaptation of environmental management systems among our suppliers.

2.3.2 Hazardous substances

The use of chemicals in society has increased significantly in recent decades. Concern about the negative effects of hazardous substances has resulted in stricter legal frameworks in many countries. Full control of hazardous substances in our products and processes is therefore business critical.

ABB is committed to phasing out the use of hazardous substances in our products and processes, where technically and economically feasible. We have developed lists of prohibited and restricted substances to guide this process and update them regularly, in line with developments in international regulations. Such restrictions include for example components containing brominated flame retardants, PCB, PCT or mercury, or the use of cadmium in surface treatment.

2.3.3 Materials selection

Some of the sustainability activities concerning motor production are the guidelines for selecting construction materials:

- Aim at minimizing the quantity of materials in order to reduce the weight of the product.
- Reduce the number of different materials in the product.
- Minimize the number of components used in the product and select as small components as possible.
- Choose recycled materials or a combination of virgin and recycled material for the product instead of virgin material, if possible.
- When using virgin materials, choose materials that are recyclable.
- Prefer materials for which recovery and recycling systems have been established, such as steel, aluminum, and unmixed thermoplastics.

3. Standards

3	Standards	24
3.1	Definitions	25
3.2	Standards tables	26
3.2.1	The main standards for low voltage motors	26
3.2.2	The main EU directives for motors	27
3.2.3	Efficiency determination for motors outside Europe	27
3.3	Direction of rotation	28
3.4	Cooling	29
3.5	Degrees of protection: IP code/IK code	31
3.6	Standard voltage ranges	32
3.7	Voltage and frequency	33
3.8	Tolerance	34
3.9	Mounting arrangements	35
3.10	Dimensions	36
3.11	Output power and frame size ratio	38

Standards

ABB Motors and Generators build motors and generators to comply with international IEC and CENELEC standards. Within the European Union, ABB takes into account relevant EU-regulations, VDE-regulations, and DIN-standards. Motors conforming to other national and international specifications are also available.

All ABB motor production units are ISO 14001 certified and conform to applicable EU directives.

ABB strongly supports the drive to harmonize international standards and actively contributes to various technical committees and working groups within IEC, CENELEC and IECEx system.

Standards

3.1 Definitions

Directive

A legislative act of the European Union to achieve a particular result in the EU member states.

Standard

A specifications document established as a result of consensus between international technical experts working for a standards organization such as the International Electrotechnical Commission (IEC), the European Committee for Electrotechnical Standardization (CENELEC), or a national standards organization (NEMA in the US, DKE in Germany).

Adoption of IEC standards by any country or manufacturer is entirely voluntary.

Harmonized standard

A standard that provides conformity with corresponding requirements of an EU directive to demonstrate compliance with EU legislation.

Harmonized standards are published in the Official Journal (OJ) of the European Union and their application is mandatory to the extent that a corresponding directive requires.

3.2 Standards tables

The following tables serve as reference lists for electrical and mechanical standards that apply to most induction motors depending on motor type and type of protection.

3.2.1 The main standards for low voltage motors

Electrical	Title
IEC / EN 60034-1	Rating and performance
IEC / EN 60034-2-1	Standard methods for determining losses and efficiency from tests (excluding machines for traction vehicles)
IEC / EN 60034-2-2	Specific methods for determining separate losses of large machines from tests – Supplement to IEC 60034-2-1
IEC / EN 60034-8	Terminal markings and direction of rotation
IEC / EN 60034-11	Thermal protection
IEC / EN 60034-12	Starting performance of single-speed three-phase cage induction motors
IEC / TS 60034-17	Cage induction motors when fed from converters – Application guide
IEC / TS 60034-25	Guidance for the design and performance of AC motors specifically designed for converter supply
IEC / EN 60034-26	Effects of unbalanced voltages on the performance of three-phase cage induction motors
IEC / EN 60034-30	Efficiency classes of single-speed three-phase cage induction motors (IE-Code)
IEC / TS 60034-31 CLC/TS 60034-31	Selection of energy-efficient motors including variable speed applications – Application guide
IEC 60038	IEC standard voltages
IEC 60050-411	International electrotechnical vocabulary – Chapter 411: Rotating machines

Mechanical	Title
IEC / EN 60034-5	Degrees of protection provided by the integral design of rotating electrical machines (IP code) - Classification
IEC / EN 60034-6	Methods of cooling (IC code)
IEC / EN 60034-7	Classification of types of construction, mounting arrangements and terminal box position (IM Code)
IEC / EN 60034-9	Noise limits
IEC / EN 60034-14	Mechanical vibration of certain machines with shaft heights 56 mm and higher - Measurement, evaluation and limits of vibration severity
IEC / EN 60072-1	Dimensions and output series for rotating electrical machines Part 1: Frame sizes 56 to 400 and flange numbers 55 to 1080
IEC / EN 60529	Degree of protection provided by enclosure (IP Code)
EN 50102	Degrees of protection provided by enclosures for electrical equipment against external mechanical impacts (IK code)
EN 50347	General purpose three-phase induction motors having standard dimensions and outputs - Frame sizes 56 to 315 and flange numbers 65 to 740

Specific applications in addition to the standards above

Smoke extraction motors	Title
EN 12101-3	Smoke and heat control systems Specification for powered smoke and heat exhaust ventilators
Hazardous areas	Title
IEC / EN 60079-0	Equipment - General requirements
IEC / EN 60079-1	Equipment protection by flameproof enclosures “d”
IEC / EN 60079-7	Equipment protection by increased safety “e”
IEC / EN 60079-15	Equipment protection by type of protection “n”
IEC / EN 60079-31	Equipment dust ignition protection by enclosure “t”
IEC / EN 60079-14	Electrical installations design, selection and erection
IEC / EN 60079-17	Electrical installations inspections and maintenance
IEC / EN 60079-19	Equipment repair, overhaul and reclamation
IEC / EN 60050-426	International electrotechnical vocabulary- Part 426: Equipment for explosive atmospheres
IEC / EN 60079-10-1	Classification of areas – Explosive gas atmospheres
IEC / EN 60079-10-2	Classification of areas – Combustible dust atmospheres

3.2.2 The main EU directives for motors

Directive	Date	Field of application
1994/9/EC ATEX	23 March 1994	Motors used in potentially explosive atmospheres
1999/92/EC Workers Directive	16 December 1999	Installations, incl. motors, in potentially explosive atmospheres
2006/95/EC LV Directive	12 December 2006	Low voltage motors except for those used in potentially explosive atmospheres
2009/125/EC Ecodesign Directive	22 July 2009	Framework for setting ecodesign requirements for energy-related products
2009/640/EC Motor regulation	22 July 2009	Electric motors
Amendment to Motor regulation	Sep/Oct. 2013	Electric motors

3.2.3 Efficiency determination for motors outside Europe

USA	IEEE 112-B CSA C390-10	Test procedure for polyphase induction motors and generators Test methods, marking requirements, and energy efficiency levels for three-phase induction motors
Canada	CSA C390-10	Test methods, marking requirements, and energy efficiency levels for three-phase induction motors
China	GB/T 1032: 2005	Test methods for induction motors; includes methods identical to IEC 60034-2-1: 2007 with segregated losses
India	IS 12615: 2011	Methods identical to IEC 60034-2-1: 2007 (in line with IEC 60034-30: 2008)
Brazil	NBR 17094-1: 2008	Three-phase induction motors – Tests
Australia, New Zealand	AS/NZS 1359.102.3 or IEC 60034-2-1 AS/NZS 1359.102.1 or IEC 60034-2	Method A for determining losses and efficiency – Three-phase cage induction motors Method B for determining losses and efficiency – Three-phase cage induction motors

3.3 Direction of rotation

Motor cooling is independent of the direction of rotation, except for certain larger two-pole motors.

When the mains supply is connected to stator terminals marked U, V, and W of a three-phase motor and the mains phase sequence is L1, L2, L3, the motor will rotate clockwise, as viewed from the D-end. The direction of rotation can be reversed by interchanging any two of the three conductors connected to a starter switch or motor.



3.4 Cooling

A designation system concerning the method of cooling is based on the standard IEC 60034-6.

Example







ABB can deliver motors with the following cooling options.

- IC 410: totally enclosed motors without a fan
- IC 411: totally enclosed standard motors, frame-surface cooled with a fan
- IC 416: totally enclosed motors with an auxiliary fan motor
- IC 418: totally enclosed motors, frame -surface cooled without a fan
- IC 31W: inlet and outlet pipe or duct circulated: water-cooled motors

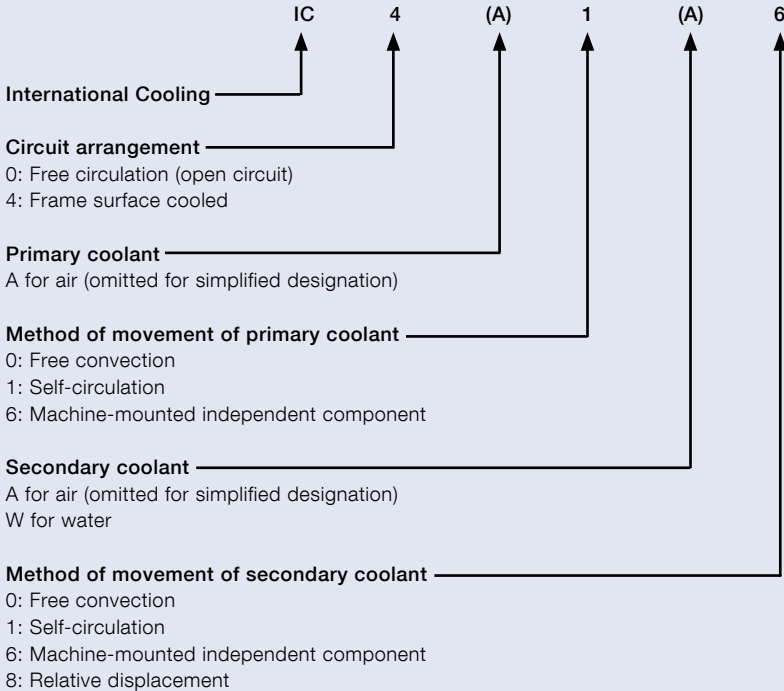
Note:

Motors without a fan can deliver the same output power as those with a standard configuration (with a fan of their own) when installed according to IC 418.

ABB's motor range

	Cooling designation	Motor range
	IC 410	Typical examples are roller table motors
	IC 411	Standard motors
	IC 416	Standard motors (normally bigger frame sizes only equipped with auxiliary fan)
	IC 418	Fan application motors without a cooling fan, cooled by the airstream of the driven machine
	IC 31 W	Water cooled motors

3.5 Degrees of protection: IP code/IK code

Classifications of the degrees of protection provided by enclosures of rotating machines are based on:

- IEC / EN 60034-5 or IEC / EN 60529 for IP code
- EN 50102 for IK code

IP protection:

Protection of persons against getting in contact with (or approaching) live parts and against contact with moving parts inside the enclosure. Also protection of the machine against the ingress of solid foreign objects. Protection of machines against the harmful effects of the ingress of water.

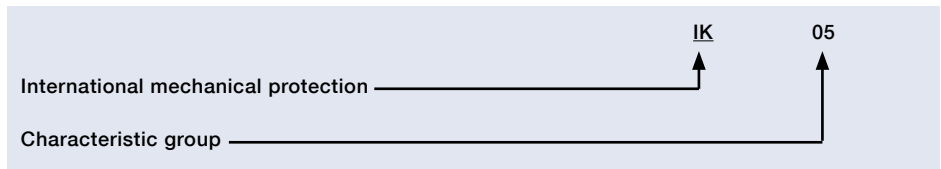
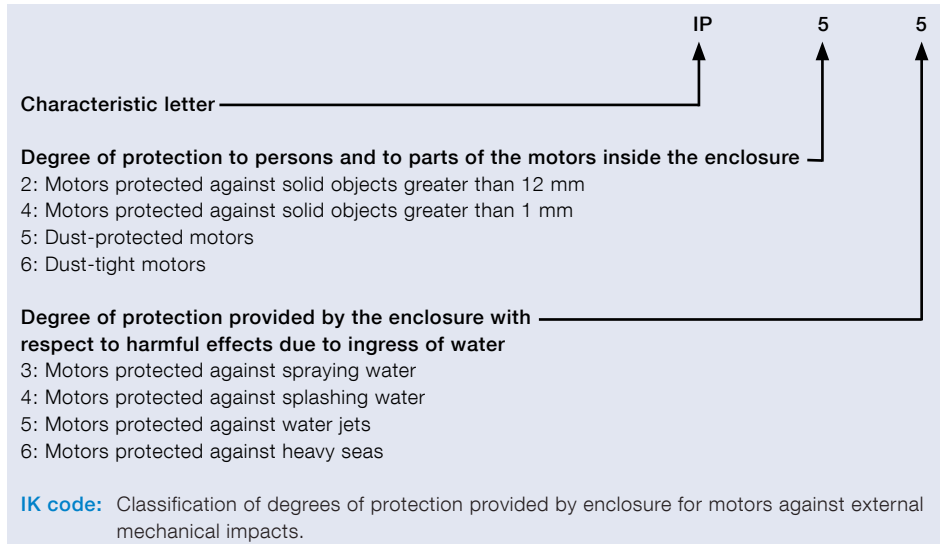

Relation between IK code and impact energy

IK code	IK 00	IK 01	IK 02	IK 03	IK 04	IK 05	IK 06	IK 07	IK 08	IK 09	IK 10
Impact	*	0.15	0.2	0.35	0.5	0.7	1	2	5	10	20
Energy									ABB Standard		
Joule											

*not protected according to EN 50102

3.6 Standard voltage ranges

ABB provides motors for markets worldwide. To be able to meet customers' requirements, motors are designed for operation over a wide range of voltages. The most common voltage codes are S, D, E, and F. These cover the most common voltages used worldwide. Other voltage ranges are available on request.

The following table covers the most common voltage ranges.

Direct-on-line start or, with Δ-connection, also Y/Δ-start

Motor size	S		D	
	50 Hz	60 Hz	50 Hz	60 Hz
56-100	220-240 VΔ 380-415 VY	- 440-480 VY	380-415 VΔ 660-690 VY	440-480 VΔ -
112-132	220-240 VΔ 380-415 VY	- 440-480VY	380-415 VΔ 660-690 VY	440-480 VΔ -
160-450 ¹⁾	220, 230 VΔ 380, 400, 415 VY	440 VY	380, 400, 415 YΔ 660 VY	440-480 -

Motor size	E		F	
	50 Hz	60 Hz	50 Hz	60 Hz
56-100	500 VΔ	²⁾	500 VY	²⁾
112-132	500 VΔ	²⁾	500 VY	²⁾
160-450	500 VΔ	²⁾	²⁾	²⁾

A chart of world voltages can be obtained from from an ABB motors sales office.

¹⁾ The voltage range varies from type to type. Check the valid values in relevant product catalogs.
²⁾ On request.

Motors for other voltages

Motors wound for a given voltage at 50 Hz can also be used for other voltages. Efficiency, power factor, and speed remain approximately the same. Exact motor-specific values are available on request.

Motor wound for	230 V		400 V		500 V		690 V	
Connected to (50 Hz):	220 V	230 V	380 V	415 V	500 V	550 V	660 V	690 V
	% of values in a 400 V, 50 Hz network		% of values in a 400 V, 50 Hz network		% of values in a 400 V, 50 Hz network		% of values in a 400 V, 50 Hz network	
Output	100	100	100	100	100	100	100	100
I_N	180	174	105	98	80	75	61	58
I_S/I_N	90	100	90	106	100	119	90	100
T_S/T_N	90	100	90	106	100	119	90	100
T_{max}/T_N	90	100	90	106	100	119	90	100

3.7 Voltage and frequency

The impact on temperature rise caused by voltage and frequency fluctuation is defined in IEC 60034-1. The standard divides the combinations into two zones, A and B. Zone A is the combination of voltage deviation of $\pm 5\%$ and frequency deviation of $\pm 2\%$. Zone B is the combination of voltage deviation of $\pm 10\%$ and frequency deviation of $\pm 3\%$. This is illustrated in figure 3.1.

Motors are capable of supplying the rated torque in both zones A and B, but the temperature rise will be higher than at rated voltage and frequency. Motors can be run in zone B only for a short period of time.

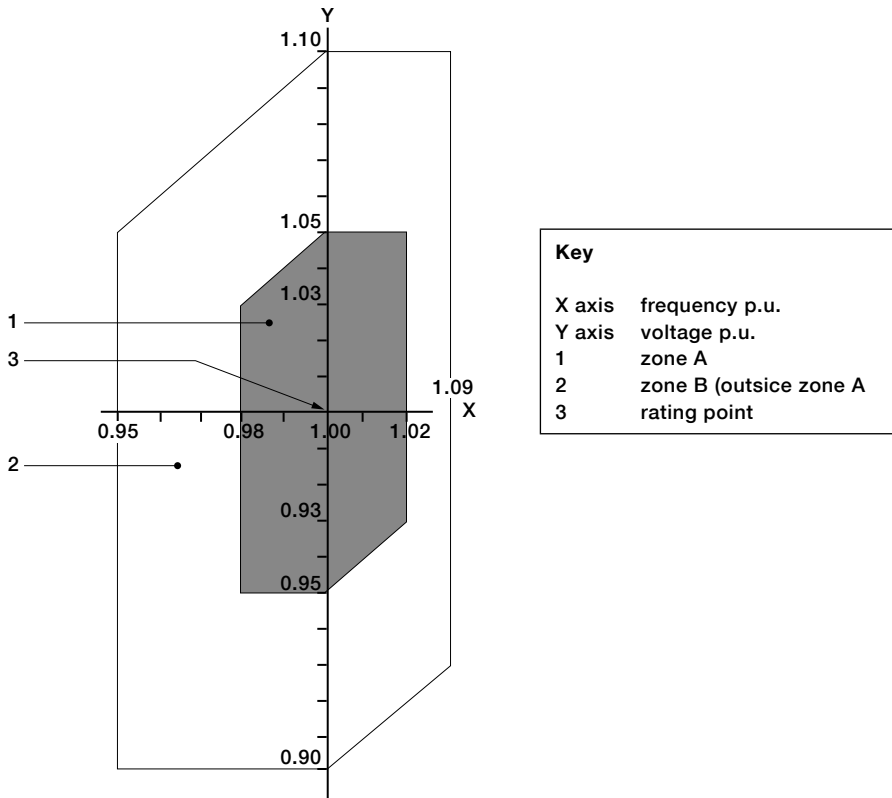

Figure 3.1 Voltage and frequency deviation in zones A and B.

3.8 Tolerances

In accordance with IEC 60034-1, tolerance is the maximum allowed deviation between the test result and the declared value on the rating plate (or in the catalog). Test results are based on test procedures in accordance with IEC 60034-2-1, IEC 60034-9, and IEC 60034-12.

	Efficiency	Power factor	Locked rotor current	Locked rotor torque	Pull-up torque	Moment of inertia	Noise level
P_N (kW) ≤ 150	-15 % (1- η)	-1/6 (1-cos ϕ)	+20 % of the current	[-15 % +25 %] of the torque	-15 % of the value	± 10 % of the value	+3 dB(A)
P_N (kW) > 150	-10 % (1- η)	-1/6 (1-cos ϕ)	+20 % of the current	[-15 % +25 %] of the torque	-15 % of the value	± 10 % of the value	+3 dB(A)
Slip							
P_N (kW) < 1	± 30 %						
P_N (kW) ≥ 1	± 20 %						

3.9 Mounting arrangements

International standards

IM mounting arrangements

Example of designations according to Code II

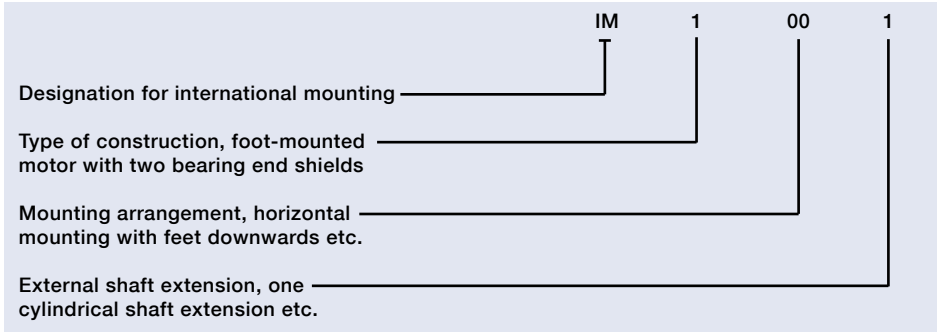

Examples of common mounting arrangements

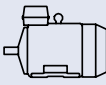
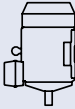
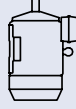
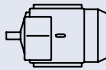
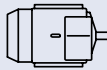
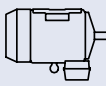
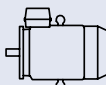
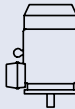
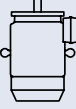
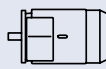
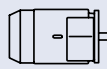
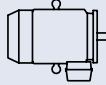
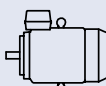
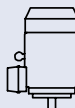
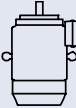
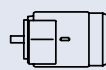
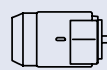
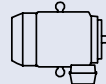
Code I	IM B3	IM V5	IM V6	IM B6	IM B7	IM B8
Code II	IM 1001	IM1011	IM 1031	IM1051	IM 1061	IM 1071
Foot-motor						
Code I	IM B5	IM V1	IM V3	*) IM 3051	*) IM 3061	*) IM 3071
Code II	IM 3001	IM 3011	IM3031			
Flange-mounted motor, large flange with clearance fixing holes.						
Code I	IM B14	IM V18	IM V19	*) IM 3651	*) IM 3661	*) IM 3671
Code II	IM 3601	IM 3611	IM 3631			
Flange-mounted motor, small flange with tapped fixing holes.						
*) Not stated in IEC 60034-7						

3.10 Dimensions

International standards IM mounting arrangements

This is a sample of a typical dimension drawing. Dimension drawings are available in catalogs, and on the ABB web site.

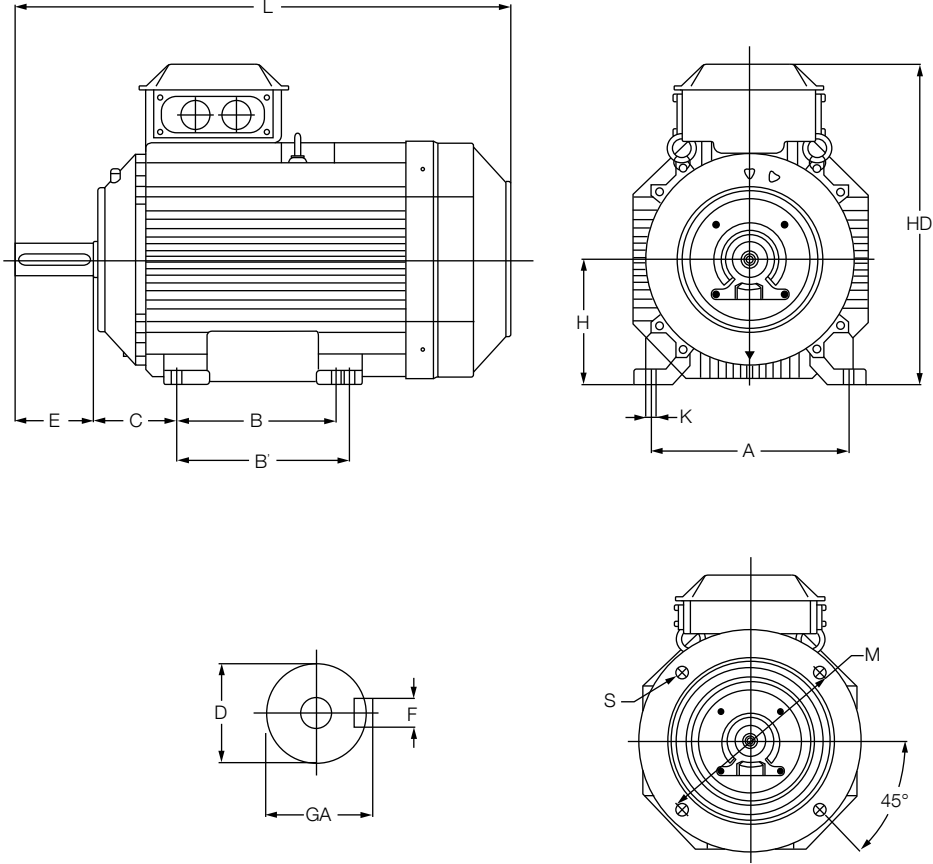

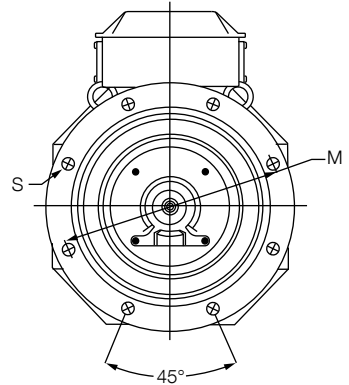
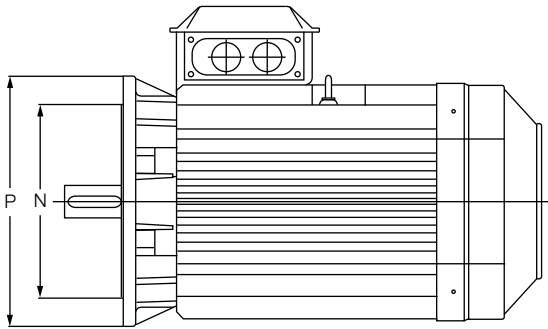

Letter symbols for the most common dimensions:

A = distance between center lines of fixing holes (end view)

F = width of the keyway of the shaft extension at D-end

L = overall length of the motor with a single shaft extension

B = distance between the center lines of the fixing holes (side view)

GA = distance from the top of the key to the opposite surface of the shaft extension at D-end

M = pitch circle diameter of the fixing holes

B' = distance between the center lines of the auxiliary fixing holes

H = distance from the centre line of the shaft to the bottom of the feet

N = diameter of the spigot

C = distance of the shoulder on the shaft at D-end to the center line of the mounting holes in the nearest feet

HD = distance from the top of the lifting eye, the terminal box, or other most salient part mounted on the top of the motor to the bottom of the feet

P = outside diameter of the flange, or in the case of a non-circular outline twice the maximum radial dimension

D = diameter of the shaft extension at D-end

S = diameter of the fixing holes in the mounting flange, or nominal diameter of thread.

E = length of the shaft extension from the shoulder at the D-end

K = diameter of the holes or width of the slots in the feet of the motor

3.11 Output power and frame size ratio

Several countries have implemented a minimum energy efficiency performance standard (MEPS) through national legislation. IEC sets guidelines for testing and classification of motors according to standards. The following tables present two applications of power vs. frame size standards, one for Europe and another for Brazil.

In Europe, the CENELEC standard **EN 50347** lays down data for rated output and mounting, i.e. shaft height, fixing dimensions and shaft extension dimensions, for various degrees of protection and sizes. It covers totally enclosed fan-cooled squirrel-cage motors at 50 Hz, frame sizes 56 M to 315 M.

Standard output								
Frame size	Shaft extension diameter		Rated output				Flange number	
	2 poles mm	4,6,8 poles mm	2 poles kW	4 poles kW	6 poles kW	8 poles kW	Free holes (FF)	Tapped holes (FT)
56	9	9	0.09 or 0.12	0.06 or 0.09			F100	F65
63	11	11	0.18 or 0.25	0.12 or 0.18			F115	F75
71	14	14	0.37 or 0.55	0.25 or 0.37			F130	F85
80	19	19	0.75 or 1.1	0.55 or 0.75	0.37 or 0.55		F165	F100
90S	24	24	1.5	1.1	0.75	0.37	F165	F115
90L	24	24	2.2	1.5	1.1	0.55	F165	F115
100L	28	28	3	2.2 or 3	1.5	0.75 or 1.1	F215	F130
112M	28	28	4	4	2.2	1.5	F215	F130
132S	38	38	5.5 or 7.5	5.5	3	2.2	F265	F165
132M	38	38	-	7.5	4 or 5.5	3	F265	F165
160M	42	42	11 or 15	11	7.5	4 or 5.5	F300	F215
160L	42	42	18.5	15	11	7.5	F300	F215
180M	48	48	22	18.5	-	-	F300	
180L	48	48	-	22	15	11	F300	
200L	55	55	30 or 37	30	18.5 or 22	15	F350	
225S	55	60	-	37	-	18.5	F400	
225M	55	60	45	45	30	22	F400	
250M	60	65	55	55	37	30	F500	
280S	65	75	75	75	45	37	F500	
280M	65	75	90	90	55	45	F500	
315S	65	80	110	110	75	55	F600	
315M	65	80	132	132	90	75	F600	

Table 3.1 Power - frame size correlation according to CENELEC

Brazil requires that motors imported to Brazil comply with the national NBR standards for low voltage motors. NBR 17094-1:2008 defines the frame-power relation as shown in the table below.

Power kW	Frame HP	2 poles	4 poles	6 poles	8 poles
0.18	0.25	63	63	71	71
0.25	0.33	63	63	71	80
0.37	0.50	63	71	80	90S
0.55	0.75	71	71	80	90L
0.75	1	71	80	90S	90L
1.1	1.5	80	80	90S	100L
1.5	2	80	90S	100L	112M
2.2	3	90S	90L	100L	132S
3.0	4	90L	100L	112M	132M
3.7	5	100L	100L	132S	132M
4.7	6	112M	112M	132S	160M
5.5	7.5	112M	112M	132M	160M
7.5	10	132S	132S	132M	160L
9.2	12.5	132S	132M	160M	180M/L
11.0	15	132M	132M	160M	180L
15.0	20	160M	160M	160L	180L
18.5	25	160M	160L	180L	200L
22	30	160L	180M	200L	225S
30	40	200M	200M	200L	225M
37	50	200L	200L	225M	250S
45	60	225S	225S	250S	250M
55	75	225M	225M	250M	280S
75	100	350M	250M	280S	280M
90	125	280S	280S	280M	315M
110	150	280M	280M	315M	315M
132	175	315S	315S	315M	355
150	200	315S	315S	315M	355
185	250	315S	315M	355	355
220	300	355	355	355	355
260	350	355	355	355	355
300	400	-	355	355	-
330	450	-	355	355	-
370	500	-	355	-	-

Table 3.2 Power - frame size correlation according to NBR

4. Electrical design – induction motors

4.	Electrical design – induction motors	42
4.1	The induction motor	43
4.2	Insulation	44
4.3	Thermistors	45
4.4	Ambient temperatures and high altitudes	45
4.5	Starting methods	46
4.5.1	Direct-on-line (DOL) starting	46
4.5.2	Star-delta starting	46
4.5.3	Soft starters	47
4.5.4	Starting with a variable speed drive	48
4.6	Starting limitations	49
4.7	Duty types	56
4.8	Uprating	60
4.9	Efficiency and types of losses	61
4.10	Power factor	62
4.11	Air flow and air speed	65
4.12	Connection diagram	66

Electrical design – induction motors

The electrical and mechanical design chapters of this guide focus on induction motors.

Designing motors that deliver good all-round performance involves a delicate balance between a number of factors which include efficiency, cost, temperature rise, vibration, noise, bearing selection, and slot and fan design. Only the correct balance will result in high quality motors which are efficient and reliable and provide a long service life.

Electrical design – induction motors

4.1 The induction motor

ABB's low voltage induction motors are three-phase electric motors whose rotating power is based on electromagnetic induction. The current led to motor windings creates a rotating magnetic field, which induces a voltage in the rotor bars. The bars form a closed circuit where current begins to circulate, forming another magnetic field. The magnetic fields of the rotor and stator interact in such a way that the rotor starts following the magnetic field of the stator, thus producing torque.

In the nature of asynchronous motors, the rotor tends to fall behind the speed of the magnetic field in the stator. When mechanical load increases on the motor shaft, the difference in speed (slip) increases, and a higher torque is produced.

ABB's low voltage induction motors cover the power range from 0.06 to 1000 kW.

4.2 Insulation

ABB uses class F insulation, which, with temperature rise class B, is the most commonly required insulation system for industrial motors.

Class F insulation system

- Max. ambient temperature 40 °C
- Max. permissible temperature rise 105 K
- Hotspot temperature margin +10 K

Class B temperature rise

- Max. ambient temperature 40 °C
- Max. permissible temperature rise 80 K
- Hotspot temperature margin +10 K

The use of class F insulation with class B temperature rise gives ABB products a 25 °C safety margin. This can be exploited to increase the loading of the motor for limited periods, to operate at higher ambient temperatures or altitudes or with greater voltage and frequency tolerances. It can also be exploited to extend insulation life. For instance, already a 10 K temperature reduction has a relevant effect on insulation lifetime.

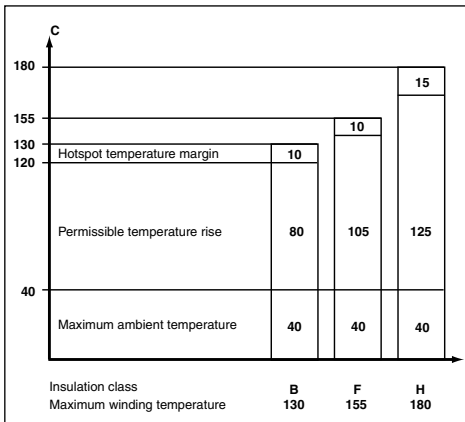

Figure 4.1 Safety margins per insulation class

4.3 Thermistors

Thermistors are temperature-dependent resistors inserted inside the winding heads – one for each phase – to control motor temperature. Under a certain temperature, the thermistor shows a fairly constant low resistance, but from a certain temperature upwards this resistance dramatically increases by a factor of 20 and more. The resistance change is transformed into connection signals (warning or disconnection) resulting in thermal machine protection.

4.4 Ambient temperatures and high altitudes

Normal motors are designed for operation at a maximum ambient temperature of 40 °C and at a maximum altitude of 1000 meters above sea level. If a motor is operated at higher ambient temperatures, it should be derated according to the table below. Note that when the output power of a standard motor is derated, the relative values, such as I_S/I_N , in catalogs will change.

Ambient Temperature, °C	30	40	45	50	55	60	70	80
Permitted output, % of rated output	107	100	96.5	93	90	86.5	79	70

Height above sea level, m	1000	1500	2000	2500	3000	3500	4000
Permitted output, % of rated output	100	96	92	88	84	80	76

Table 4.1 Permitted output in high ambient temperatures or at high altitudes

4.5 Starting methods

The most common motor starting methods are introduced next. They are: direct-on-line and star-delta starting, and starting with a softstarter or variable speed drive.

Connection transients

It is important to remember that the term ‘starting current’ refers to a steady-state root-mean-square (rms) value. This is the value measured when, after a few cycles, the transient phenomena have died out. The peak value of the transient current may be about 2.5 times the steady-state starting current, but decays rapidly. The starting torque of the motor behaves similarly, and this should be borne in mind if the moment of inertia of the driven machine is high, since the stresses on the shaft and coupling can be great.

4.5.1 Direct-on-line (DOL) starting

The simplest way to start a squirrel cage motor is to connect it directly to the mains supply. In this case, a direct-on-line (DOL) starter is the only starting equipment required. However, the limitation of this method is that it results in a high starting current, often several times the rated current of the motor. Also the starting torque is very high, and may result in high stresses on the couplings and the driven application. Even so, it is the preferred method except when there are special reasons for avoiding it.

4.5.2 Star-delta starting

If it is necessary to restrict the starting current of a motor because of supply limitations, the star-delta (Y/ Δ) method can be employed. When a motor wound for 400 V/ Δ , for instance, is started with winding Y connected, this method will reduce the starting current to about 30 per cent of the current reached with DOL, and the starting torque will be reduced to about 25 per cent of its DOL value.

However, before using this method, it must be determined whether the reduced motor torque is sufficient to accelerate the load over the motor’s speed range.

Contact your nearest ABB sales office for the MotSize dimensioning tool, or download it from our web site. ABB offers a full range of low voltage products for motor starting and control.

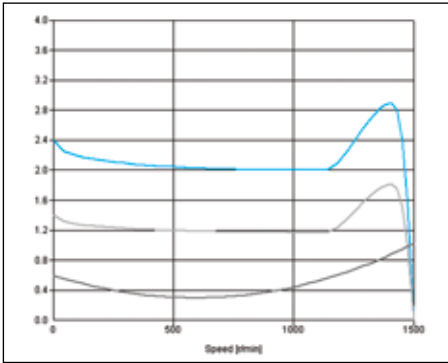

A sample taken from the MotSize dimensioning program showing DOL starting curves for a cast iron motor:

1. Starting torque at U_n
2. Starting torque at 80 % U_n
3. Torque load

Figure 4.2 DOL starting

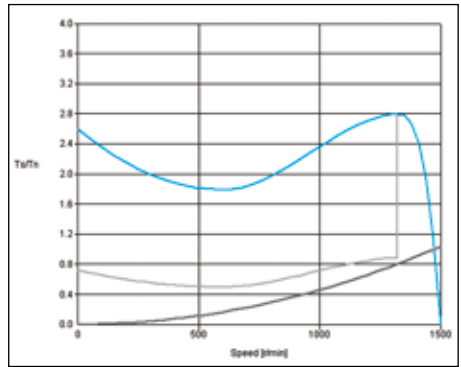

A sample taken from the MotSize dimensioning program showing Y/Δ starting curves for an aluminum motor:

1. Starting torque at U_n
2. Starting torque at 80 % U_n
3. Torque load

Figure 4.3 Star-delta starting

4.5.3 Softstarters

A softstarter limits the starting current of the motor and so provides a smooth start. The magnitude of the starting current is directly dependent on the static torque requirement during a start and on the mass of the load to be accelerated. ABB softstarters have adjustable settings to meet any application requirements. Gradually increasing the motor voltage, and thereby torque, results in a very smooth start. When the motor is well up in speed, it is common to bypass the softstarter to avoid power loss from the semiconductors during continuous operation. To bypass the softstarter it is common to use an externally mounted, AC-1 rated contactor.

A bypass contact can also be built into the softstarter like in ABB's softstarter ranges PSR, PSE, and PSTB. These softstarters are among the most compact available in the market.

In the ABB softstarter, the main circuit is controlled by semiconductors instead of mechanical contacts. Each phase is provided with two anti-parallel connected thyristors, which allows current to be switched at any point within both positive and negative half-cycles.

Lead time is controlled by the firing angle of the thyristor which, in turn, is controlled by a built-in printed circuit board.

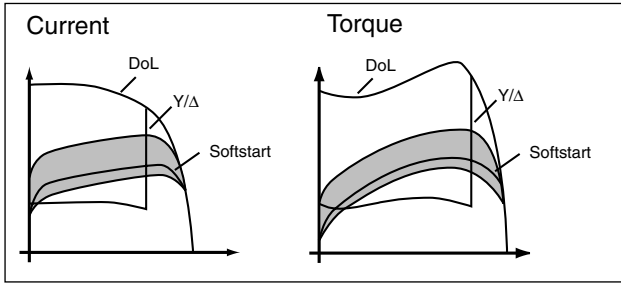

Figure 4.4 Impact of softstarters on current and torque



Figure 4.5 ABB softstarters

4.5.4 Starting with a variable speed drive

Speed regulation by a variable speed drive is a great advantage when there is need to adjust speed during continuous run, but it is usually not the optimal solution only for starting and stopping the motor.

With a frequency converter, the rated motor torque is available already at a low speed, and the starting current is low, between 0.5 and 1 times rated motor current, and at maximum 1.5 times nominal current. Another available feature in drives is softstop, which is useful when a smooth stop is equally desirable as a smooth start, for example in operating water pumps or running conveyor belts.

4.6 Starting limitations

Starting time

Starting time is a function of load torque, inertia and motor torque. As the starting current is always much higher than the rated current, an excessively long starting period will cause harmful temperature rise in the motor. The high current also causes electromechanical stress on the motor.

Permitted starting time

In view of temperature rise, the starting time must not exceed the time specified in the table. The figures in the table apply to starting from normal operating temperature. When starting from cold, the figures can be doubled.

Motor size	Starting method	Number of poles			
		2	4	6	8
56	DOL	25	40	NA	NA
63	DOL	25	40	NA	NA
71	DOL	20	20	40	40
80	DOL	15	20	40	40
90	DOL	10	20	35	40
100	DOL	10	15	30	40
112	DOL	20	15	25	50
	Y/D	60	45	75	150
132	DOL	15	10	10	60
	Y/D	45	30	30	20
160	DOL	15	15	20	20
	Y/D	45	45	60	60
180	DOL	15	15	20	20
	Y/D	45	45	60	60
200	DOL	15	15	20	20
	Y/D	45	45	60	60
225	DOL	15	15	20	20
	Y/D	45	45	60	60
250	DOL	15	15	20	20
	Y/D	45	45	60	60
280	DOL	15	18	17	15
	Y/D	45	54	51	45
315	DOL	15	18	16	12
	Y/D	45	54	48	36
355	DOL	15	20	18	30
	Y/D	45	60	54	90
400	DOL	15	20	18	30
	Y/D	45	60	54	90
450	DOL	15	20	18	30
	Y/D	45	60	54	90

Table 4.2 Maximum starting times in seconds for occasional starting, single-speed motors

Permitted frequency of starting and reversing

When a motor is subjected to frequent starting, it cannot be loaded at its rated output because of thermal starting losses in the windings. Calculating the permissible output power can be based on the number of starts per hour, the moment of inertia of the load, and the speed of the load. Mechanical stresses may also impose a limit below that of thermal factors.

$$\text{Permitted output power } P = P_N \sqrt{1 - \frac{m}{m_o}}$$

P_N = rated output of motor in continuous duty

$$m = \frac{(J_M + J'_L)}{J_m} \times X$$

X = number of starts per hour

J_M = moment of inertia of motor in kgm^2

J'_L = moment of inertia of load in kgm^2 , recalculated for the motor shaft, i.e. multiplied by $(\text{load speed} / \text{motor speed})^2$. The moment of inertia J (kgm^2) equals $\frac{1}{4} GD^2$ in kpm^2 .

m_o = highest permitted number of starts per hour for motor at no load, as stated in the table at right.

Highest permitted number of reversals per hour at no load $m_r = m_o / 4$.

Motor size	Number of poles			
	2	4	6	8
56	12000	9000	-	-
63 A, B	11200	8700	-	-
71 A, B	9100	8400	16800	15700
80 A, B	5900	8000	16800	11500
90 L	3500	7000	12200	11500
100 L	2800	-	8400	-
112 M	1700	6000	9900	16000
132 M	1700	2900	4500	6600
160 ML	650	-	-	5000
180 ML	400	1100	-	-
200 ML	385	-	1900	-
225 SM	-	900	-	2350
250 SM	300	900	1250	2350
280 SM, ML	125	375	500	750
315 SM, ML	75	250	375	500
355 SM, ML, LK	50	175	250	350
400 L, LK	50	175	250	350
450 L	On request			

Table 4.3 Highest permitted number of starts/hour at no load, m_0

Starting characteristics

Catalogs usually state the maximum starting time as a function of motor size and speed. However, the standard IEC 60034-12 specifies the permitted moment of inertia of the driven machine instead of starting time. For small motors, the thermal stress is greatest in the stator winding, whereas for larger motors it is greatest in the rotor winding.

If the torque curves for the motor and the load are known, the starting time can be calculated with the following equation.

$$T_M - T_L = (J_M + J_L) \times \frac{d\omega}{dt}$$

where

- T_M = motor torque, Nm
- T_L = load torque, Nm
- J_M = moment of inertia of the motor, kgm²
- J_L = moment of inertia of the load, kgm²
- ω = angular velocity of the motor

In case of gearing T_L and J_L will be replaced by T'_L and J'_L respectively. If the starting torque T_s and maximum torque T_{max} of the motor, together with the nature of the load, are known, the approximate starting time can be calculated with the following equation.

$$t_{st} = \frac{(J_M + J'_L)}{T_{acc}} \times K_1$$

where

- t_{st} = starting time, s
- T_{acc} = acceleration torque, Nm
- K_1 = speed constant ($2\varphi \frac{f}{p}$) where p represents the number of pole pairs

Speed constant	Poles					Frequency Hz
	2	4	6	8	10	
n_m	3000	1500	1000	750	600	50
K_1	314	157	104	78	62	
n_m	3600	1800	1200	900	720	60
K_1	377	188	125	94	75	

Table 4.4 Speed constant K1 as a function of frequency and pole pairs.

The average value for T_M :

$$T_M = 0.45 \times (T_s + T_{max})$$

$$T_{acc} = T_M - K_L \times T_L$$

K_L can be obtained from the table below:

	Lift motion	Fan	Piston pump	Flywheel
K_L	1	1/3	0.5	0

Examples from the ABB calculation program on starting time

Load

Load type	Pump or Fan
Duty cycle	S1(IEC)
Load Inertia J[kg-m ²]	20,0
Max Inertia J	94
GD2[kg-m ²]	80
Gear Ratio	1,00

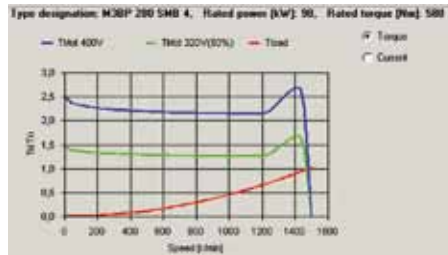

U/Un[%]	Time start.[s]
DOL (100)	3,2
DOL (80)	6,3

U/Un[%]	Speed [r/min]
DOL (100)	1483
DOL (80)	1473

If there is gearing between the motor and the driven machine, the load torque must be recalculated to motor speed with the following formula.

$$T'_L = T_L \times \frac{n_L}{n_M}$$

The moment of inertia must also be recalculated:

$$J'_L = J_L \times \left(\frac{n_L}{n_M} \right)^2$$

Examples of starting performance with various load torques
4-pole motor, 160 kW, 1475 r/min

Torque of the motor

$$T_N = 1040 \text{ Nm}$$

$$T_s = 1.7 \times 1040 = 1768 \text{ Nm}$$

$$T_{\max} = 2.8 \times 1040 = 2912 \text{ Nm}$$

Moment of inertia of motor: $J_M = 2.5 \text{ kgm}^2$

The load is geared down in a ratio of 1:2

Torque of the load

$$T_L = 1600 \text{ Nm at } n_L = n_M/2 \text{ r/min}$$

$$T'_L = 1600 \times 1/2 = 800 \text{ Nm at } n_M \text{ r/min}$$

Moment of inertia of the load

$$J_L = 80 \text{ kgm}^2 \text{ at } n_L = n_M/2 \text{ r/min}$$

$$J'_L = 80 \times (1/2)^2 = 20 \text{ kgm}^2 \text{ at } n_M \text{ r/min}$$

Total moment of inertia

$$J_M + J'_L \text{ at } n_M \text{ r/min}$$

$$2.5 + 20 = 22.5 \text{ kgm}^2$$

Example 1:

$$T_L = 1600 \text{ Nm} \quad T'_L = 800 \text{ Nm}$$

Constant during acceleration

$$T_{\text{acc}} = 0.45 \times (T_s + T_{\max}) - T'_L$$

$$T_{\text{acc}} = 0.45 \times (1768 + 2912) - 800 = 1306 \text{ Nm}$$

$$t_{\text{st}} = \frac{(J_M + J'_L)}{T_{\text{acc}}} \times K_1$$

$$t_{\text{st}} = \frac{22.5 \times 157}{1306} = 2.7 \text{ s}$$

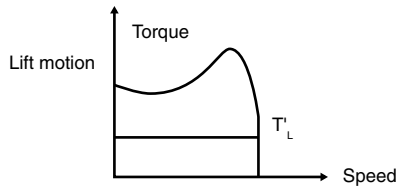

Example 2:

$$T_L = 1600 \text{ Nm} \quad T'_L = 800 \text{ Nm}$$

Linear increase during acceleration

$$T_{acc} = 0.45 \times (T_S + T_{max}) - \frac{1}{2} \times T'_L$$

$$T_{acc} = 0.45 \times (1768 + 2912) - \frac{1}{2} \times 800 = 1706 \text{ Nm}$$

$$t_{st} = (J_M + J'_L) \times K_1 / T_{acc}$$

$$t_{st} = 22.5 \times \frac{157}{1706} = 2.1 \text{ s}$$

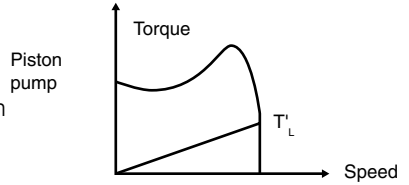

Example 3:

$$T_L = 1600 \text{ Nm} \quad T'_L = 800 \text{ Nm}$$

Square-law increase during acceleration

$$T_{acc} = 0.45 \times (T_S + T_{max}) - \frac{1}{3} \times T'_L$$

$$T_{acc} = 0.45 \times (1768 + 2912) - \frac{1}{3} \times 800 = 1839 \text{ Nm}$$

$$t_{st} = \frac{(J_M + J'_L)}{T_{acc}} \times K_1$$

$$t_{st} = \frac{22.5 \times 157}{1839} = 1.9 \text{ s}$$

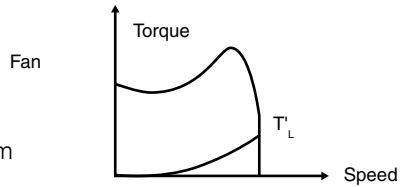

Example 4:

$$T_L = 0$$

$$T_{acc} = 0.45 \times (T_S + T_{max})$$

$$T_{acc} = 0.45 \times (1768 + 2912) = 2106 \text{ Nm}$$

$$t_{st} = \frac{(J_M + J'_L)}{T_{acc}} \times K_1$$

$$t_{st} = \frac{22.5 \times 157}{2106} = 1.7 \text{ s}$$

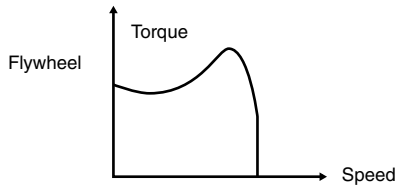

4.7 Duty types

The duty types are indicated by S1...S10 according to IEC 60034-1 and VDE 0530 Part 1. The outputs given in the catalogs are based on continuous running duty, S1, with rated output.

In the absence of an indication of the rated duty type, continuous running duty is assumed when considering motor operation.

S1 Continuous running duty

Operation on constant load of sufficient duration for thermal equilibrium to be reached.

Designation S1.

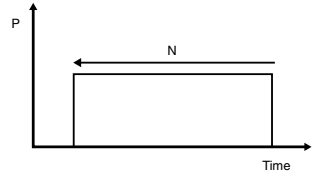

S2 Short-time duty

Time shorter than that required to reach thermal equilibrium, followed by a rest and a de-energized period of sufficient duration to allow motor temperature to reach ambient temperature or cooling temperature.

10, 30, 60, and 90 minutes are recommended for the rated duration of the duty cycle.

Designation for example S2 60 min.

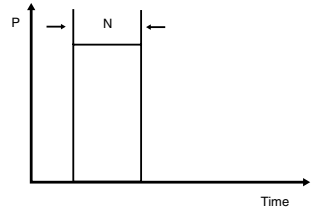

S3 Intermittent duty

A sequence of identical duty cycles, each including a period of operation at constant load, a rest and a de-energized period. The duty cycle is too short for thermal equilibrium to be reached. The starting current does not significantly affect temperature rise.

Recommended values for the cyclic duration factor are 15, 25, 40, and 60 percent. The duration of one duty cycle is 10 min.

Designation for example S3 25 %.

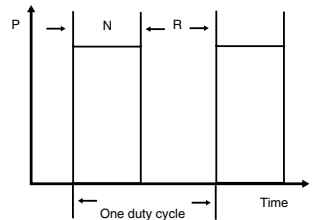

$$\text{Cyclic duration factor} = \frac{N}{N + R} \times 100 \%$$

Explanation of symbols used in this and the following figures

P = output power

F = electrical braking

P_N = full load

D = acceleration

V = operation of no load

N = operation under rated condition

R = at rest and de-energized

S4 Intermittent duty with starting

A sequence of identical duty cycles, each cycle including a significant period of starting, operation at constant load, a rest and a de-energized period.

The cycle-time is too short for thermal

equilibrium to be reached. In this duty type, the motor is brought to rest by the load or by mechanical braking which does not thermally load the motor.

The following parameters are required to fully define the duty type: the cyclic duration factor, the number of duty cycles per hour (c/h), the moment of inertia of the load (J_L) and the moment of inertia of the motor (J_M).

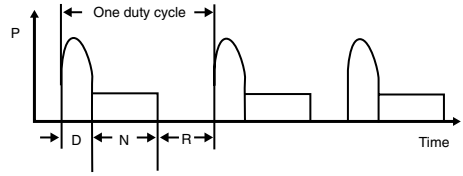

Designation for example S4 25 % 120 c/h $J_L = 0.2 \text{ kgm}^2$ $J_M = 0.1 \text{ kgm}^2$.

$$\text{Cyclic duration factor} = \frac{D + N}{D + N + R} \times 100 \%$$

S5 Intermittent duty with starting and electrical braking

A sequence of identical duty cycles, each cycle consisting of a significant starting period, a period of operation at constant load, a period of rapid electric braking, a rest and a de-energized period.

The duty cycles are too short for thermal equilibrium to be reached. The following parameters are required to fully define the

duty type: the cyclic duration factor; the number of duty cycles per hour (c/h), the moment of inertia of the load (J_L) and the moment of inertia of the motor (J_M).

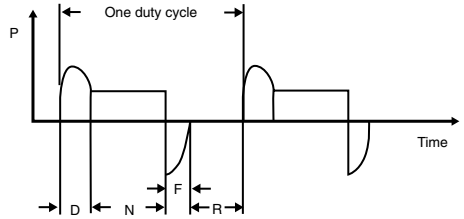

Designation for example S5 40 % 120 c/h $J_L = 2.6 \text{ kgm}^2$ $J_M = 1.3 \text{ kgm}^2$.

$$\text{Cyclic duration factor} = \frac{D + N + F}{D + N + F + R} \times 100 \%$$

S6 Continuous operation periodic duty

A sequence of identical duty cycles, each cycle consisting of a period at constant load and a period of operation at no-load. The duty cycles are too short for thermal equilibrium to be reached.

Recommended values for the cyclic duration factor are

15, 25, 40, and 60 percent. The duration of the duty cycle is 10 min.

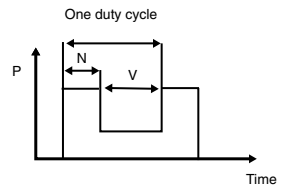

Designation for example S6 40 %. Cyclic duration factor = $100 \% \times \frac{N}{N + V}$

S7 Continuous operation periodic duty with electrical braking

A sequence of identical duty cycles, each cycle consisting of a starting period, a period of operation at constant load, and a period of braking. The braking method is electrical braking such as counter-current braking. The duty cycles are too short for thermal equilibrium to be reached.

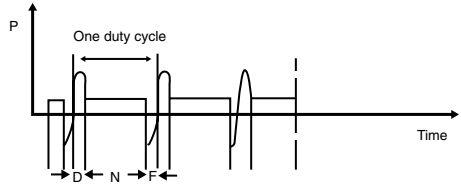

The following parameters are required to fully define the duty type: the number of duty cycles per hour (c/h), the moment of inertia of the load (J_L), and the moment of inertia of the motor (J_M).

Designation for example S7 500 c/h $J_L = 0.08 \text{ kgm}^2$ $J_M = 0.08 \text{ kgm}^2$.

S8 Continuous-operation periodic duty with related load speed changes

A sequence of identical duty cycles, each cycle consisting of a starting period, a period of operation at constant load corresponding to a predetermined speed, followed by one or more periods of operation at other constant loads corresponding to different speeds. There is no rest or a de-energized period. The duty cycles are too short for thermal equilibrium to be reached.

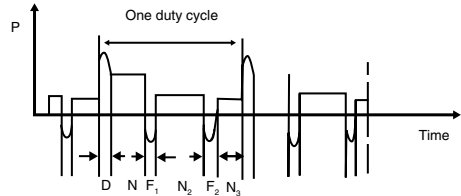

This duty type is used for example by pole-changing motors. The following parameters are required to fully define the duty type: the number of duty cycles per hour (c/h), the moment of inertia of the load (J_L), the moment of inertia of the motor (J_M), and the load, speed, and cyclic duration factor for every operation speed.

Designation for example S8 30 c/h $J_L = 63.8 \text{ kgm}^2$ $J_M = 2.2 \text{ kgm}^2$.

24 kW	740 r/min	30%
60 kW	1460 r/min	30%
45 kW	980 r/min	40%

$$\text{Cyclic duration factor 1} = \frac{D + N_1}{D + N_1 + F_1 + N_2 + F_2 + N_3} \times 100 \%$$

$$\text{Cyclic duration factor 2} = \frac{F_1 + N_2}{D + N_1 + F_1 + N_2 + F_2 + N_3} \times 100 \%$$

$$\text{Cyclic duration factor 3} = \frac{F_2 + N_3}{D + N_1 + F_1 + N_2 + F_2 + N_3} \times 100 \%$$

S9 Duty with non-periodic load and speed variations

A duty in which, generally, load and speed vary non-periodically within the permissible operating range. This duty includes frequently applied overloads that may greatly exceed the full loads. For this duty type, suitable full load values should be taken as the basis of the overload concept.

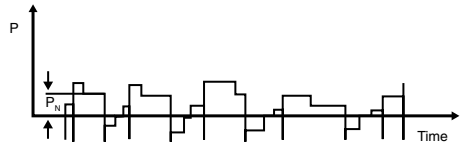

S10 Duty with discrete constant loads and speeds

A duty consisting of a specific number of discrete values of load (or equivalent loading) and if applicable, speed, each load/speed combination being maintained for sufficient time to allow the machine to reach thermal equilibrium. The minimum load within a duty cycle may have the value zero (no-load or de-energized and at rest).

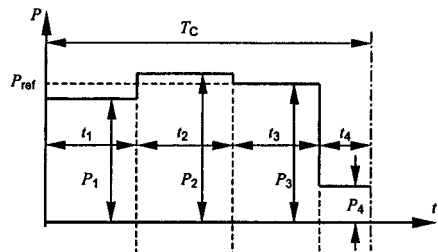

The appropriate designation is S10, followed by the per-unit quantities $p\Delta t$ for the respective load and its duration, and the per-unit quantity T_L for the relative thermal life expectancy of the insulation system. The reference value for the thermal life expectancy is the thermal life expectancy at rating for continuous running duty and permissible limits of temperature rise based on duty type S1. For a time de-energized and at rest, the load shall be indicated by the letter r.

Example: S10 $p\Delta t = 1.1/0.4; 1/0.3; 0.9/0.2; r/0.1$ $T_L = 0.6$

The value of T_L should be rounded to the nearest multiple of 0.05.

For this duty type a constant load appropriately selected and based on duty type S1 shall be taken as the reference value ($'P_{ref}'$ in the figure) for the discrete loads.

Note: The discrete values of load will usually be equivalent loading based on integration over a period of time. It is not necessary that each load cycle be exactly the same, only that each load within a cycle be maintained for sufficient time for thermal equilibrium to be reached, and that each load cycle is capable of being integrated to give the same relative thermal life expectancy.

4.8 Uprating

Because of the lower temperature rise in the motor in short-time or intermittent duty, it is usually possible to take higher output from the motor in these types of duty than in continuous duty, S1. The tables below show some examples of this. Attention must be paid to the motor's maximum torque, T_{\max}/T_N must be >1.8 referred to increased output.

Short-time duty S2	Poles	Permitted output as % of rated output in S1 continuous duty for motor size		
		56 – 100	112 - 250	280 - 450
30 min	2	105	125	130
	4 - 8	110	130	130
60 min	2 - 8	100	110	115

Table 4.5 Permitted output in short time duty S2 as percentage of rated output

Intermittent duty S3	Poles	Permitted output as % of rated output in S1 continuous duty for motor size		
		56 – 100	112 - 250	280 - 450
15 %	2	115	145	140
	4	140	145	140
	6, 8	140	140	140
25 %	2	110	130	130
	4	130	130	130
	6, 8	135	125	130
40 %	2	110	110	120
	4	120	110	120
	6, 8	125	108	120
60 %	2	105	107	110
	4	110	107	110
	6, 8	115	105	110

Table 4.6 Permitted output in intermittent duty S3 as percentage of rated output

4.9 Efficiency and types of losses

Efficiency of a motor is a measure of how well it is capable of converting electrical energy into mechanical work. Lost energy is emitted in the form of heat. To increase efficiency, losses have to be reduced.

Motor losses can be divided into five main categories. The first two are classified as no-load losses because they remain constant regardless of the load. The first category is iron losses in the core, the second windage and friction losses. Load losses, which vary with the load, are classified into copper losses in the stator, rotor losses, and stray load losses. All losses can be influenced by motor design and construction solutions.

No-load losses

Iron losses in the core are caused by the energy required to overcome the opposition to changing magnetic fields in the core material. These losses can be reduced by using better-quality steel and by lengthening the core to reduce magnetic flux density.

Windage and friction losses are caused by air resistance and bearing friction. Improved bearing design and bearing seal selection, air flow and fan design affect these losses. The fan must be large enough to provide adequate cooling, but not so large as to reduce efficiency and increase noise. To reach an optimal cooling effect in each ABB motor, blade sizes and pitches vary in different fan models.

Load losses

Of load losses, stator copper losses (also referred to as I^2R losses) are caused by heating from the current flow through the resistance of the stator winding. Techniques for reducing these losses include optimizing the stator slot design.

Rotor losses are caused by rotor currents and iron losses. These losses are reduced for example by increasing the size of the conductive bars and end rings to produce lower resistance. Stray load losses are the result of leakage fluxes induced by load currents. These can be decreased by improving slot geometry.

Completely new motor designs are also developed to increase efficiency beyond known limits. The synchronous reluctance motor is an example of these new designs.

Efficiency values for rated output are listed in the technical data tables in ABB product catalogs.

4.10 Power factor

A motor consumes both active power, which it converts into mechanical work, and reactive power, which is needed for magnetization and which is not converted to work.

The active and reactive power, represented in the diagram (below) by P and Q, together give the apparent power S. The ratio between active power, measured in kW, and apparent power, measured in kVA, is known as the power factor. The angle between P and S is usually designated as φ , and the power factor itself is designated as $\cos \varphi$.

Power factor is usually between 0.7 and 0.9. It is lower for small motors and higher for large motors.

Power factor is determined by measuring the input power, voltage and current at rated output power. The power factor stated is subject to a tolerance of $(1 - \cos \varphi) / 6$.

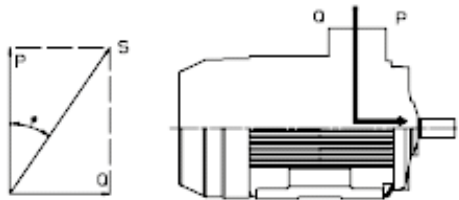

If there are many motors in an installation, a lot of reactive power will be consumed and therefore the power factor will be lower. For this reason, power suppliers sometimes require the power factor of an installation to be increased. This is done by connecting capacitors to the supply which absorb reactive power and thus raise the power factor.

Phase compensation

With phase compensation, the capacitors are usually connected in parallel with the motor, or with a group of motors. However, in some cases, over-compensation can cause an induction motor to self-excite and run as a generator. Therefore, to avoid complications, it is a normal practice not to compensate for more than the no-load current of the motor.

The capacitors must not be connected in parallel with single phases of the winding; such an arrangement may make the motor difficult or impossible to start with star-delta starting.

If a two-speed motor with separate windings has phase compensation on both windings, the capacitors should not remain in circuit on the unused winding.

Under certain circumstances, such capacitors can cause increased heating of the winding and possibly also vibration.

The following formula is used to calculate the size (per phase) of a capacitor for a mains frequency of 50 Hz:

$$C = 3.2 \cdot 10^6 \cdot \frac{Q}{U_2}$$

Where C = capacitance, μF
 U = capacitor voltage, V
 Q = reactive power, kvar.

Reactive power is obtained from:

$$Q = K \cdot P \frac{P}{\eta}$$

Where K = constant from table on right
 P = rated power of motor, kW
 η = efficiency of motor

cos ϕ without compensation	Constant K Compensation to cos ϕ =			
	0.95	0.90	0.85	0.80
0.50	1.403	1.248	1.112	0.982
0.51	1.358	1.202	1.067	0.936
0.52	1.314	1.158	1.023	0.892
0.53	1.271	1.116	0.980	0.850
0.54	1.230	1.074	0.939	0.808
0.55	1.190	1.034	0.898	0.768
0.56	1.150	0.995	0.859	0.729
0.57	1.113	0.957	0.822	0.691
0.58	1.076	0.920	0.785	0.654
0.59	1.040	0.884	0.748	0.618
0.60	1.005	0.849	0.713	0.583
0.61	0.970	0.815	0.679	0.548
0.62	0.937	0.781	0.646	0.515
0.63	0.904	0.748	0.613	0.482
0.64	0.872	0.716	0.581	0.450
0.65	0.841	0.685	0.549	0.419
0.66	0.810	0.654	0.518	0.388
0.67	0.779	0.624	0.488	0.358
0.68	0.750	0.594	0.458	0.328
0.69	0.720	0.565	0.429	0.298
0.70	0.692	0.536	0.400	0.270
0.71	0.663	0.507	0.372	0.241
0.72	0.635	0.480	0.344	0.214
0.73	0.608	0.452	0.316	0.186
0.74	0.580	0.425	0.289	0.158
0.75	0.553	0.398	0.262	0.132
0.76	0.527	0.371	0.235	0.105
0.77	0.500	0.344	0.209	0.078
0.78	0.474	0.318	0.182	0.052
0.79	0.447	0.292	0.156	0.026
0.80	0.421	0.266	0.130	
0.81	0.395	0.240	0.104	
0.82	0.369	0.214	0.078	
0.83	0.343	0.188	0.052	
0.84	0.317	0.162	0.026	
0.85	0.291	0.135		
0.86	0.265	0.109		
0.87	0.238	0.082		
0.88	0.211	0.055		
0.89	0.184	0.027		
0.90	0.156			

Table 4.7 Phase compensation

Power factor values

The power factors for rated output are listed in the technical data tables in product catalogs.

The table below illustrates typical power factors. ABB supplies guaranteed values on request.

As the table shows, a motor with a power factor of 0.85 has 3/4 load value of 0.81, 1/2 load value of 0.72 and 1/4 value of 0.54.

Power factor $\cos \varphi$				
2 - 12 poles				
$1.25 \times P_N$	$1.00 \times P_N$	$0.75 \times P_N$	$0.50 \times P_N$	$0.25 \times P_N$
0.92	0.92	0.90	0.84	0.68
0.91	0.91	0.89	0.83	0.66
0.90	0.90	0.88	0.82	0.64
0.89	0.89	0.87	0.81	0.62
0.88	0.88	0.86	0.80	0.60
0.88	0.87	0.84	0.76	0.58
0.87	0.86	0.82	0.73	0.56
0.86	0.85	0.81	0.72	0.54
0.85	0.84	0.80	0.71	0.52
0.84	0.83	0.78	0.70	0.50
0.84	0.82	0.76	0.66	0.46
0.84	0.81	0.74	0.63	0.43
0.83	0.80	0.73	0.60	0.40
0.82	0.79	0.72	0.59	0.38
0.82	0.78	0.71	0.58	0.36
0.81	0.77	0.69	0.55	0.36
0.81	0.76	0.68	0.54	0.34
0.80	0.75	0.67	0.53	0.34
0.79	0.74	0.66	0.52	0.32
0.78	0.73	0.65	0.51	0.32
0.78	0.72	0.62	0.48	0.30
0.78	0.71	0.61	0.47	0.30
0.77	0.70	0.60	0.46	0.30

Table 4.8 Power factors for induction motors

4.11 Air flow and air speed

When the motor is ordered without self-cooling, attention must be paid to ensure sufficient cooling by other means. Air flow and air speed between the ribs of the motor frame must at the minimum meet the values given in the table below. The values correspond to 50 Hz network supply; with 60 Hz supply an increase of 20 % is needed.

Shaft height	Pole number	Air speed m/s	Air flow m ³ /s	Shaft height	Pole number	Air speed m/s	Air flow m ³ /s
280	2	9.6	0.46	355	2	10	0.82
	4	8.5	0.39		4	13	1.1
	6	6.5	0.32		6	11.5	1.0
	8	7.6	0.36		8	8.5	0.7
315 SM. ML	2	8.3	0.46	400	2	15	1.4
	4	9.4	0.56		4	13	1.25
	6	7.5	0.4		6	11	1.1
	8	7.6	0.43		8	8	0.8
315 LK	2	7.8	0.47	450	2	15	2.0
	4	15	0.80		4	15	2.0
	6	9.5	0.53		6	13	1.7
	8	8.8	0.49		8	10	1.25

Table 4.9 Air flow and air speed

4.12 Connection diagrams

Connection of three phases, single speed motors

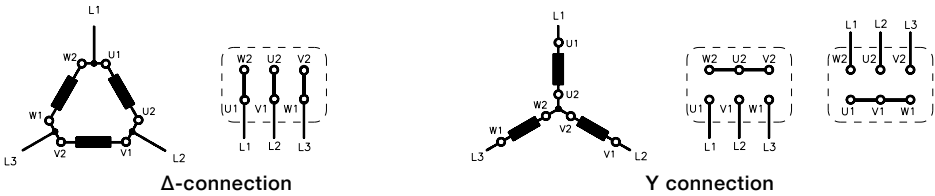

Figure 4.6 Connection of three-phase single-speed motors

Connection of two-speed motors

Two-speed motors are normally connected as illustrated below; direction of rotation is discussed in the Standards chapter. Motors of normal design have six terminals and one earth terminal in the terminal box. Motors with two separate windings are normally Δ - Δ connected. They can also be Y/Y, Y/ Δ or Δ /Y connected. Motors with one winding, Dahlander-connection, are connected Δ /YY when designed for constant torque drives. For a fan drive, the connection is Y/YY.

A connection diagram is supplied with every motor.

When starting a motor using Y Δ connection, always refer to the connection diagram supplied by the starter manufacturer.

1. Two separate windings Y/Y

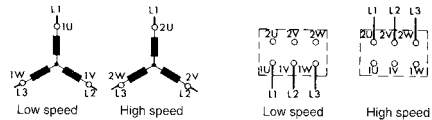

2. Two separate windings Δ / Δ

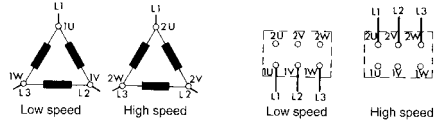

3. Dahlander-connection Δ /YY

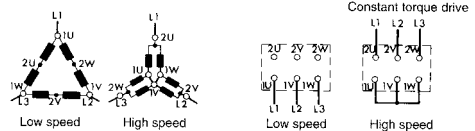

4. Dahlander-connection Y/YY

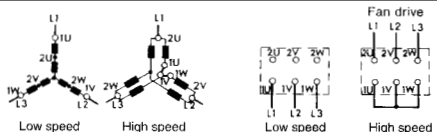

Figure 4.7 Connection options for two-speed motors

5. Mechanical design

5.	Mechanical design	68
5.1	Motor construction	69
5.2	Frame constructions	70
5.3	Terminal boxes	71
5.4	Bearings	73
5.5	Drain holes and humidity	74
5.6	External radial and axial forces of the motor	75
5.7	Balancing	75
5.8	Vibration	76
5.9	Surface treatment	77

Mechanical design

This chapter introduces the main parts of an induction motor and the mechanical design of the parts that are of highest interest from motor usage point of view: the frame and terminal box, bearings, and drain holes.

The basics of radial and axial forces as well as the standards that define requirements for motor balancing, vibration measurement, and surface treatment are also discussed.

Mechanical design

5.1 Motor construction

The induction motor is an electric motor that uses electric power to induce rotation of the rotor. The main parts of the induction motor and their functions are as follows.

Stator - the stationary part of the motor which surrounds the rotor. The stator consists of copper wires (windings) wound in between the stator's slots to carry supply current and to induce a rotating magnetic field to interact with the rotor.

Rotor - the rotating core part of the motor fixed to the shaft. The rotor consists of a stack of thin steel laminations and a squirrel-cage construction of conductive bars that react with the magnetic field of the motor and produce torque to turn the shaft.

Shaft - the rotating innermost part of the motor which transmits the rotor's rotational power to the application fixed to the motor's D-end.

Bearing - bearings surround the motor's shaft at both ends and reduce friction between the motor frame and shaft.

Frame – cast-iron or aluminum casing which covers the motor's core parts and provides electrical connections.

D-end - the drive end of the motor.

N-end - the non-drive end of the motor.

The following is a cross-section of a three-phase induction motor and its main parts.

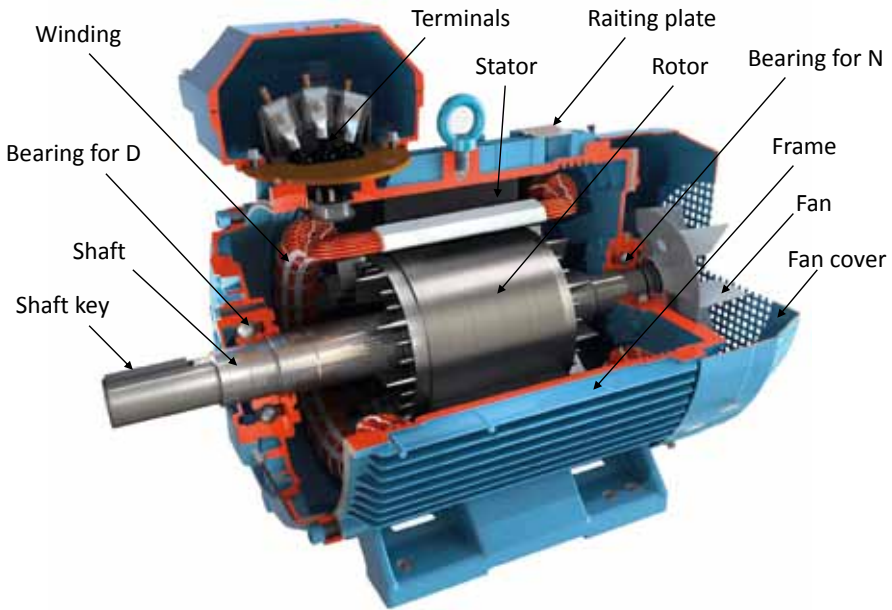

Figure 5.1 Cross-section of a cast-iron induction motor

5.2 Frame constructions

Totally enclosed electric motors are available in a choice of aluminum and cast iron frames for different application areas. Cast-iron-framed motors are typically used in heavy industries where better durability against chemicals and corrosion is required, whereas aluminum-framed motors are better suited for lighter applications such as pumps and fans.

5.3 Terminal boxes

The terminal box is mounted either on top of the motor or on either side of the motor. Technical details may vary from type to type, and the most recent information can be found in the relevant product catalogs.

The terminal boxes of aluminum motors in sizes 56 to 180 are normally provided with knock-out openings, and sizes 200 to 250 have terminal boxes with two gland plates.

The terminal boxes of cast-iron motors in sizes 71 to 250 are equipped with blank cover plates for connection flanges. In motor sizes 280 to 450, the terminal box is equipped with cable glands or cable boxes (Figures 5.2 and 5.3). There is a wide range of cable glands and cable boxes available as options, also equipped with EMC modules and cable clamps.

The terminal box material is either cast iron or aluminum, depending on the motor type. The main terminal box is attached either on top, on side, or at a 45 degree angle on the side. It may also be connected to the motor with extended cables, so-called flying leads. In case of accessories such as thermistors or heating elements, one or more auxiliary terminal boxes may be attached to the motor. Non-standard designs of terminal boxes, such as non-standard size and degree of protection, are available as options.

A standard motor usually has six phase connections and at least one earthing connection (Figures 5.4 and 5.5). The necessary connection parts and a connection diagram are delivered together with the motor, under the terminal box cover



Figure 5.2 Connection flange with cable glands

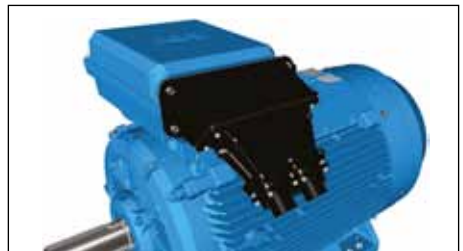

Figure 5.3 Angle adapter and cable-sealing box



Figures 5.4–5.5 Typical terminal boxes in motor sizes 71 to 250 (5.4) and 280 to 315 (5.5)

The terminal box in aluminum motors allows cable entry from both sides. In small motors, the box is integrated in motor frame and has a blind flange on with knock-out openings on both sides (Figure 5.6). Larger aluminum motors are equipped with two connection flanges on both sides. In cast iron motor sizes 71 – 132, the box is integrated in the frame, with connection on the right-hand side (viewed from the D-end). Sizes 160 – 355 have a terminal box that can be rotated $4 \times 90^\circ$, and sizes 400 – 450 have a terminal box that can be rotated $2 \times 180^\circ$ to allow cable entry from either side of the motor. The $4 \times 90^\circ$ turnable box is available as an option for several other motor types as well.

The degree of protection of a standard terminal box is IP 55.



Figure 5.6 Terminal box integrated in motor frame

To ensure that suitable connections are supplied for the terminal box, see the specific product catalog for information on flange openings, cable diameters, and so forth.

5.4 Bearings

Motors are normally fitted with single row deep groove ball bearings. The complete bearing designation is stated on the rating plate of most motor types.

If the bearing in the D-end of the motor is replaced with roller bearings NU- or NJ-, higher radial forces can be handled. Roller bearings are especially suitable for belt-driven applications.

With high axial forces, angular contact ball bearings should be used. This type of bearing is usually needed when motors are mounted vertically. When ordering a motor with angular contact ball bearings, the method of mounting and direction and magnitude of axial force must be specified.

Single angular contact bearings are not suitable for horizontally mounted motors where low axial forces are possible. **Double** angular contact ball bearings arranged back to back or face to face are recommended in case there are low axial forces in a horizontally mounted motor, or if the direction of the axial force can change. See the product catalog of the motor in question for more specific information about bearings.

Bearing life

The normal bearing life L_{10h} of a bearing is defined, according to ISO 281, as the number of operating hours achieved or exceeded by 90 % of identical bearings in a large test series under specific conditions. 50 % of bearings achieve at least five times this lifetime.

The nominal bearing life is the lifetime that 90 % of identical bearings achieve or exceed before first signs of material weariness appear. A sufficient grease layer inside the bearing and usage in a correct application are preconditions for a nominal bearing life. By definition, 10 % of bearings can fail before they reach the nominal bearing life. Consequently, bearing life should never be confused with warranty period.

The usual values for bearing lifetime of standard motors are 40,000 h for belt drive and 100,000 h for direct coupling.

Bearing size

Reliability is the main criteria for bearing size design, taking into account the most common types of application, load of the motor and motor size. ABB uses series 63 bearings which are of robust design for longer life and higher loadability. 62 series bearings have lower noise levels, higher maximum speeds, and lower losses. See product catalogs and motor rating plates for exact bearing types.

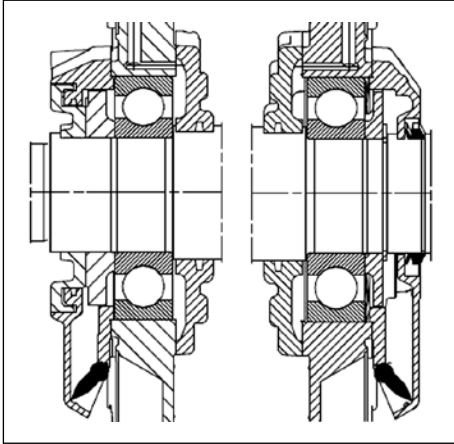

Figure 5.7 Bearing arrangements in Process performance cast iron motors, sizes 280 to 450

5.5 Drain holes and humidity

Absolute humidity is the amount of water (g/m^3) in a certain volume of air. Its value, so-called saturation value, increases when temperature increases. Relative humidity is the ratio between absolute air humidity and saturation value at a certain ambient temperature. When air cools below the temperature where the dew point is reached (relative humidity is 100 %), condensation on cold surfaces takes place.

Humidity is a risk not only to the external surface of the motor; it may also lead to internal corrosion.

When totally enclosed machines heat up, the air inside them expands; when they cool down the air volume decreases. The volume increase and decrease depend on the temperature difference to the ambient air. When the motor cools down, it may suck in particles and humidity that could damage bearings and insulation. The advantage of the drain holes is that they prevent ventilation through bearings and terminal box. Drain holes can be opened and closed with plastic plugs.

When temperature difference to ambient air is high, heating elements fitted to the winding heads may be needed to prevent corrosion of the windings. If humidity inside the motor is suspected, special measures such as insulation resistance measurement or drying in an oven need to be taken to avoid permanent damage to the motor.

5.6 External radial and axial forces of the motor

Depending on the purpose of use, and in addition to the rotational torque which is always present when running the motor, the shaft end may be affected by external radial or axial forces. Radial forces are those that are perpendicular to the shaft, while axial forces are linear with the shaft. The shaft end may also be exerted by both radial and axial forces at the same time. The maximum radial and axial forces are given in product catalogs per each motor type in Newtons. In case of radial forces, it is essential to know the exact position of the load on the shaft extension. If the shaft extension will be affected simultaneously by both radial and axial forces, the load capacity of the motor needs to be checked case by case with ABB.

5.7 Balancing

The rotor is dynamically balanced in the keyway of the shaft extension with a half-sized key (half-key balancing) according to standard ISO 8821. Balancing with a full key or without a key are also available on request. By default, ABB motors are balanced to grade G2.5 according to ISO 1940/1. Balancing to grade G1 is available on request. When the motor is ordered with higher vibration class B (see Vibration), the rotor balancing grade is G1 by default.

There are two possibilities for checking balancing quality afterwards: removing the rotor out of the motor and placing it on a balancing machine, or checking it by a vibration measurement tool. The latter can be done as follows: Lift the motor with a lifting lug and leave it hanging, or place it standing on soft rubber, for example. Run the motor at nominal speed and check vibration level. The measured vibration level should be less than 1.5 mm/s (rms) for a new motor.

5.8 Vibration



Figure 5.8 Vibration testing

Effective values (root mean squares, rms) of vibration velocity are defined in the IEC 60034-14 standard (see Table 5.1). Requirements apply across the measuring range of 10 to 1000 Hz. The purpose of this standard is to measure the vibration behavior of a machine alone at no load, under defined conditions in a reproducible and comparable way, the motor placed on elastic mounting. However, though vibration severity depends on the balancing grade used, it also essentially depends on the properties of coupling to the driven machine and coupling parts used.

Possible origins of severe vibration of coupled motors can be incorrect balancing (half key/full key), inaccurate alignment of the motor with a coupled machine, and resonance of the system (motor and foundation). ABB motors fulfill grade A vibration level by default.

Vibration is expressed in mm/s RMS.

Vibration grade	Shaft height, mm mounting	56 ≤ H ≤ 132			132 < H ≤ 280			H > 280		
		Displac. μm	Vel. mm/s	Acc. m/s ²	Displac. μm	Vel. mm/s	Acc. m/s ²	Displac. μm	Vel. mm/s	Acc. m/s ²
A	Rigid mounting	25	1.6	2.5	35	2.2	3.5	45	2.8	4.4
	Free suspension	21	1.3	2.0	29	1.8	2.8	37	2.3	3.6
B	Free suspension	11	0.7	1.1	18	1.1	1.7	29	1.8	2.8
	Rigid mounting	-	-	-	14	0.9	1.4	24	1.5	2.4

Table 5.1 Limits of maximum vibration magnitude in displacement, velocity and acceleration (rms) for shaft height H

5.9 Surface treatment

The surface treatment categorization of ABB motors is based on the ISO 12944 standard. ISO 12994-5 divides paint system durability into three categories: low (L), medium (M), and high (H). Low durability corresponds to a lifetime of 2 – 5 years, medium to 5 – 15 years, and high durability to over 15 years.

The durability range is not a guaranteed lifetime. Its purpose is to help the owner of the motor plan for appropriate maintenance intervals. More frequent maintenance may be required because of fading, chalking, contamination, wear and tear, or for other reasons.

ABB's standard surface treatment is corrosivity category C3, durability range M (which corresponds to medium corrosivity and medium durability). Special surface treatment is available in corrosivity categories

C4 and C5-M, durability class M for both. See table below for more details. In addition, surface treatment according to the NORSOK standard for offshore environments is available as an option.

The standard ABB paint color for motors is Munsell blue 8B 4.5/3.25.

Corrosivity category	Outdoor atmospheres	Indoor atmospheres	Use in ABB motors
C1, very low	Not used	Heated buildings with clean atmospheres	Not available
C2, low	Atmospheres with low level pollution, mostly rural areas.	Unheated buildings where condensation may occur, such as depots and sports halls.	Not available
C3, medium	Urban and industrial atmospheres, moderate sulfur dioxide pollution. Coastal areas with low salinity.	Production rooms with high humidity and some air pollution; food processing plants, laundries, breweries, dairies.	Standard treatment
C4, high	Industrial areas and coastal areas with moderate salinity.	Chemical plants, swimming pools, coastal ship- and boatyards.	Optional treatment, variant code 115
C5-I, very high (industrial)	Industrial areas and coastal areas with high humidity and aggressive atmosphere.	Buildings or areas with nearly permanent condensation and high pollution.	Not available
C5 -M, very high (marine)	Coastal and offshore areas with high salinity.	Buildings or areas with nearly permanent condensation and high pollution.	Optional treatment, variant code 754

Table 5.2 Atmospheric corrosivity categories and recommended environment

6. Noise

6.	Noise	80
6.1	Sound pressure level and sound power level	81
6.2	Weighting filters	82
6.3	Octave bands	83
6.4	Additional sound sources	84
6.5	Noise components of a motor	85
6.6	Airborne and structure borne noise	87
6.7	Sound pressure levels	88

Noise

Noise is subject to strict regulations today, with maximum permitted levels. Accordingly, ABB considers noise reduction a major design criterion in the development of our motors.

Noise

6.1 Sound pressure level and sound power level

Sound is pressure waves sent out by a source through the medium (usually air) in which it is immersed. Sound pressure is measured in decibels (dB) during a noise test. The ratio between the threshold of hearing and the threshold of pain is 1:10 000 000. As the pressure scale is so large and since we experience a 10 dB difference as a doubling of the perceived sound level, a logarithmic scale is employed where:

$$\text{Sound pressure level } L_p = 10 \log [(p/p_0)^2] \text{ [dB]}$$

$p_0 = 20 \mu\text{Pa}$ is the threshold of hearing for an average person

p = measured pressure [Pa]

Sound pressure is measured in a test room to eliminate the effect of reflected noise and external sources. A microphone is placed at various positions around the motor in order to measure sound radiation into different directions. Usually the distance of the microphone from the motor surface is one meter. As the noise level varies in different directions due to the influence of internal sources, a tolerance of 3 dB is applicable for the average sound pressure level. Information on sound pressure level is meaningful only if the distance from the sound source is stated. For example, $L_p = 80 \text{ dB}$ at a distance of one meter from a point sound source corresponds to 70 dB at three meters.

The measured sound level L_p can be converted into power radiated from the sound source, to determine the sound power level L_w . The formula for this is: $L_w = L_p + L_s$ (L_s is calculated from the area of the measurement surface, according to DIN). Thus, sound power level is usually a larger number than the corresponding sound pressure level. Care should be taken not to confuse the quantities.

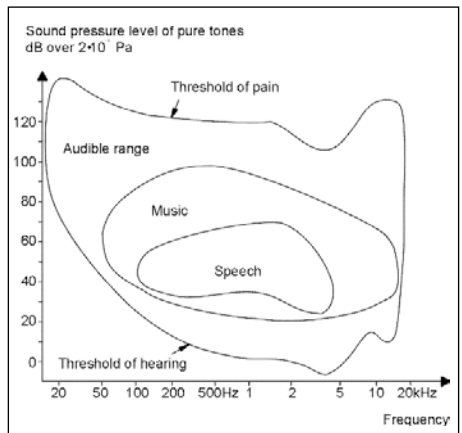

Figure 6.1 Human hearing range

The use of sound power instead of sound pressure to describe noise emission from a motor is encouraged: because sound pressure is a function of distance and environmental factors (reflections), sound power is fixed. There is an analogy to heating radiator: If you use a 1000 W electrical heater to warm up a room, the final temperature of the room depends on the insulation of the walls, room size etc. Here the temperature is analog to sound pressure.

6.2 Weighting filters

Amplifiers and various filters are used when measuring composite sound. dB figures measured in this way have A, B, or C added after them, depending on which filter is used. Normally only the LpA figure is given. It corresponds best with the perception of the ear.

Filters let through an entire frequency range, but attenuate or amplify certain parts of it. The resulting frequency curves resemble stylized 40-, 70- and 100-phon curves for pure tones.

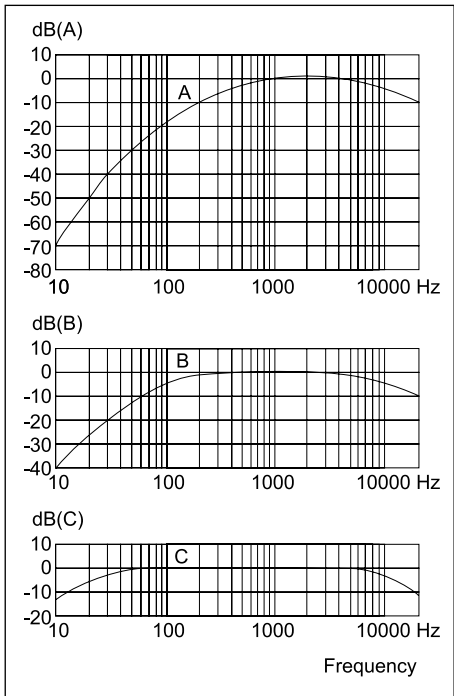

Figure 6.2 Filter characteristics for A-, B-, and C-weighting

6.3 Octave bands

Mean sound pressure level is measured with a broad band filter covering the entire frequency band. Measurement is also done with a narrow band filter to define noise level per octave band (frequency band), as the perception of the human ear is dependent on the octave band.

Octave band analysis

To get an idea of the character of composite sound, it has proven practical to divide the frequency range into octave bands with a ratio of 1:2 between the band limit frequencies. The frequency range is usually referred to by the mid-frequency of the band. The measured dB figures for all octave bands are generally shown in the form of an octave band diagram.

A system of noise rating curves known as NR curves has been developed under ISO to express the subjective degree of disturbance from different noises. These curves are intended to be used when assessing the risk of damage to hearing. Similar systems are also available. NR curve numbers signify the degree of noise.

For the octave band with a mid-frequency of 1,000 Hz, the number is equal to the sound pressure level in dB. The NR curve that touches the noise curve of the motor in question determines the motor's noise rating. The table below illustrates the use of noise rating. It shows how long a person can remain in a noisy environment without getting permanent hearing damage.

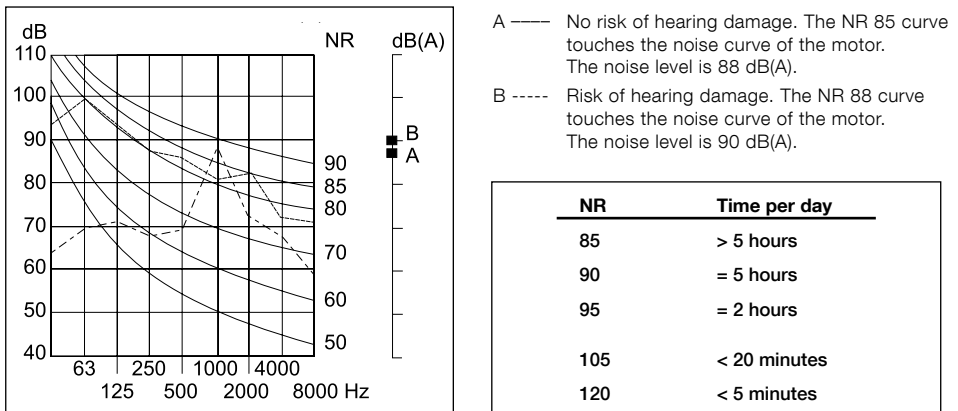

Figure 6.3 Noise rating (NR) curves

6.4 Additional sound sources

Perception of difference in sound level

A difference of 1 dB in sound level is barely detectable, whereas a 10 dB difference is perceived as doubling or halving of the sound level.

The diagrams below illustrate the total sound pressure level when several sound sources are present. For example, diagram A shows that the sound pressure level will be 3 dB higher if the sound levels of two identical sources are added together. Diagram B shows how the sound level pressure changes when the sound sources have different pressure levels.

However, before logarithmic values can be added or subtracted, they must be converted into absolute numbers. An easier way of adding or subtracting sound sources is to use the diagrams below.

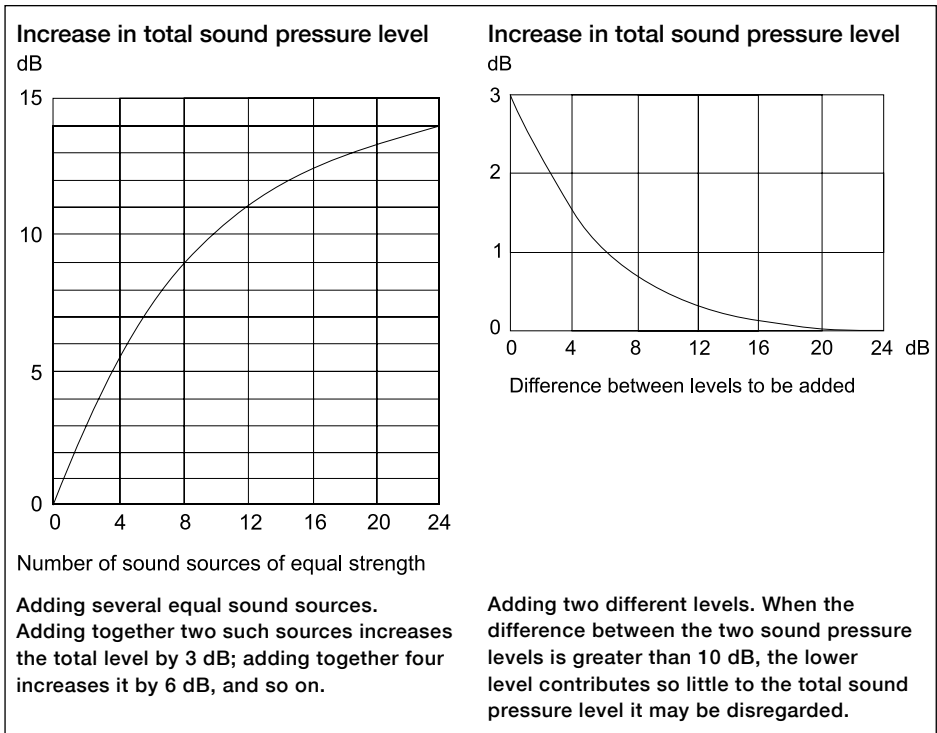

Figure 6.4 Effect of sound sources on total sound pressure level

6.5 Noise components of a motor

The total sound power emission from a motor can be considered a combination of three uncorrelated noise sources acting together. These sources are magnetic, cooling, and mechanical or rotational noise sources. Magnetic noise results from temporal and spatial variations of magnetic force distribution in the air gap. Operating a cooling fan creates most of the cooling noise. Rotational noise is generated when 1) an unsmooth body (rotor) rotates in a cavity that has obstacles and discontinuities, and 2) the shaft and the bearings interact. The magnitude of each source depends on motor type. The major factors affecting each of the sources in a motor are:

Magnetic noise P_{magn} [W]

- shaft load
- voltage, current, frequency, and supply type
- winding parameters
- slot geometry
- saturation, eccentricity, etc.

Cooling noise P_{cool} [W]

- fan type: axial, radial, or mixed flow
- rotational speed and fan diameter
- airflow velocity
- cooling method; closed vs. open, water vs. air

Mechanical or rotational noise P_{rot} [W]

- type of cooling: closed or open
- type of bearings
- speed

The total sound power level L_{Wtot} of an electrical machine in decibels can be expressed as

$$L_{\text{Wtot}} = 10 \log_{10} \left(\frac{P_{\text{magn}} + P_{\text{cool}} + P_{\text{rot}}}{P_{\text{ref}}} \right)$$

Here $P_{\text{ref}} = 1 \text{ pW}$ is the reference sound power. The equation shows that the total sound power level of an electrical machine is the result of all of the sources.

The equation is useful in considering the reduction of the total sound power of an electrical machine. Reduction measures should first be applied to the most dominant source. The following examples clarify this concept:

- For a 2-pole directly-cooled motor, the cooling noise produces 99 % of the total sound power, which means that neither the loading nor the converter supply will increase the total sound power level of the machine.
- For an 8-pole totally-closed machine with water cooling, magnetic noise dominates the total noise output and thus the loading and/or the converter supply will increase the sound power level to some extent.
- With sinusoidal supply, loading the machine can increase the magnetic sound output significantly, but with frequency converter supply, the increase of the noise output is usually much smaller.
- Cooling noise can be reduced by optimized fan design. Similarly, increasing the overall efficiency of the motor means that fan diameter can be reduced. However, the fan must be large enough to generate sufficient air flow so that adequate cooling of the motor is ensured.
- The noise level of larger motors can be reduced by fitting a silencer. On larger 2-pole motors, a unidirectional fan which rotates in one direction only and so generates less noise can be used.
- At fixed PWM converter duty, the motor noise produced in certain octave bands can change considerably depending on the switching frequency of the converter. The converter does not produce sinusoidal voltage. However, as ABB Direct Torque Control converters do not have a fixed switching frequency, the noise level is lower than would be the case if a fixed switching frequency converter was used with the same motor.

6.6 Airborne and structure-borne noise

Noise can be propagated in two ways. Airborne noise caused by the vibration of the motor's surface is propagated by air. Structure-borne noise is caused by the bearings, and by magnetic noise vibrating through the motor's frame, foundation, walls and any pipe work.

Airborne noise

Depending on the application, airborne noise can be reduced by fitting a silencer or an unidirectional fan.

Structure-borne noise

An effective method of eliminating structure-borne noise is to mount accurately dimensioned vibration dampers. Choosing vibration dampers arbitrarily, could, however, worsen the noise problem.

6.7 Sound pressure levels

The following two tables present sound pressure levels for Process performance motors in a 400 V network, at 50 Hz net duty. We still use sound pressure to describe noise levels in low voltage motors, because much of reference data uses the same quantity.

To roughly convert sound pressure level into sound power, simply add the reference value in the last column to the given sound pressure value. Both quantities are indicated in decibel. The given conversion values are only approximate and will vary also according to motor length and type

Frame size	2 poles dB(A)	4 poles dB(A)	6 poles dB(A)	8 poles dB(A)	Add to get sound power
63	54	40	38	32	5
71	58	45	42	43	6
80	60	50	47	50	6
90	63	50	44	52	7
100	62	63	49	53	7
112	68	64	56	55	8
132	73	66	61	58	8
160	69	65	59	59	9
180	69	62	59	59	9
200	72	63	63	68	10
225	74	66	63	60	10
250	75	67	63	63	11
280	75	67	63	63	11

Table 6.1 Sound pressure levels for aluminum motors

Frame size	2 poles dB(A)	4 poles dB(A)	6 poles dB(A)	8 poles dB(A)	Add to get sound power
71	58	45	42	43	6
80	60	50	47	50	6
90	69	56	44	53	7
100	68	58	49	53	7
112	70	59	66	55	8
132	70	67	57	58	8
160	69	62	59	59	9
180	69	62	59	59	9
200	72	63	63	60	10
225	74	66	63	63	10
250	75	67	66	65	11
280	77	75	70	72	12
315	78	78	70	72	13
355	83	78	75	75	14
400	82	78	77	71	15
450	85	85	81	80	15

Table 6.2 Sound pressure levels for cast iron motors

7. Installation and maintenance

7.	Installation and maintenance	90
7.1	Delivery acceptance	91
7.2	Insulation resistance check	91
7.3	Torque on terminals	92
7.4	Operation	92
7.5	Handling	93
7.6	Foundations	94
7.7	Coupling alignment	95
7.7.1	Mounting pulleys and coupling halves	96
7.8	Slide rails	97
7.9	Mounting bearings	98
7.10	Lubrication	98
7.11	Fuse rating	99

Installation and maintenance

Each motor must be installed and maintained in accordance with the manual included in the delivery of the motor. The installation and maintenance instructions in this chapter are a generic guideline.

Installation and maintenance

7.1 Delivery acceptance

1. When delivered, inspect the equipment for transit damages. If any damages are found, inform the forwarding agent immediately.
2. Check data on the rating plate. Pay special attention to voltage and winding connection (star or delta).
3. Remove transit locking if fitted, and turn shaft by hand to verify that it rotates freely.

7.2 Insulation resistance check

Before commissioning the motor, or when winding dampness is suspected, insulation resistance measurement is required.

Resistance, corrected to 25 °C, must exceed the reference value, 10 MΩ (measured with 500 V or 1000 V DC). The insulation resistance value is halved for each 20 °C rise in ambient temperature.



WARNING: *The motor frame must be grounded and windings discharged against the frame immediately after measurement to avoid the risk of electric shock.*

If the reference resistance value is not attained, the winding is too damp and must be oven-dried at 90 °C for 12 - 16 hours, followed by 105 °C for 6 - 8 hours. Drain hole plugs, if fitted, must always be removed before oven-drying, and closing valves, if fitted, must be opened.

Windings drenched in seawater normally need to be rewound.

7.3 Torque on terminals

The following torque table is a generic guideline for tightening torques. The motor's frame material and surface treatment must be taken into account when determining the tightening torque..

Thread	4.60 Nm	6.8 Nm	8.8 Nm	10.9 Nm	12.9 Nm
M2.5	0.24	-	-	-	-
M3	0.42	-	-	-	-
M5	2	4	5	8	9
M6	3	7	9	13	15
M8	8	16	21	33	37
M10	16	32	43	63	73
M12	27	55	73	108	126
M14	44	88	117	172	200
M16	67	134	180	264	309
M20	130	262	363	517	605
M22	176	353	495	704	824
M24	226	450	625	890	1040
M27	330	660	915	1300	1530
M30	450	900	1250	1780	2080
M33	610	-	-	-	-
M36	780	-	-	-	-

Table 7.1 Tightening torques for steel screws and nuts

7.4 Operation

Operating conditions

LV motors are designed for use in industrial applications under the following conditions.

- Normal ambient temperature range from - 20 °C to + 40 °C
- Maximum altitude 1,000 m above sea level
- Tolerance for supply voltage is ± 5 % and for frequency ± 2 % according to EN/IEC 600034-1 (2004).

Safety

All motors must be installed and operated by qualified personnel familiar with the relevant health and safety requirements and national legislation. Safety equipment necessary for the prevention of accidents at the installation and operation site must be provided in accordance with local requirements.



WARNING

Small motors with supply current directly switched by thermally sensitive switches can start automatically.

Accident prevention

Never stand on a motor. To prevent burns, the outer casing must not be touched during operation. Special instructions may also apply to certain motor applications such as frequency converter supply.

7.5 Handling

Storage

- Motors should always be stored in a dry, vibration-free and dust-free environment.
- Unprotected machined surfaces (shaft-ends and flanges) should be treated with an anti-corrosive.
- It is recommended that shafts are periodically rotated by hand to prevent grease migration.
- Anti-condensation heaters are recommended to avoid water condensation in the motor and should preferably be energized.
- The characteristics of electrolytic capacitors, if fitted to single-phase motors, will require “reforming” if stored over 12 months.

Transportation

Motors fitted with cylindrical-roller and/or angular-contact bearings must be secured with locking devices during transport.

Motor weight

The total weight and the center of gravity of motors with the same frame size can vary because of different output, mounting arrangements and auxiliary equipment. The actual weight of the motor is marked on the rating plate.

7.6 Foundations

The end user of the motor has full responsibility for preparation of the foundation for the motor.

The foundation must be smooth, level and, if possible, vibration free. A concrete foundation is therefore recommended. If a metal foundation is used, it should be treated with an anti-corrosive.

The foundation must be stable enough to withstand possible short-circuit forces. Short-circuit torque is primarily a damped sinusoidal oscillation and can thus have both positive and negative values. Stress on the foundation can be calculated with the help of data tables in the motor's catalog and the formula below.

$$F = 0.5 \times g \times m + \frac{4 \times T_{\max}}{A}$$

Where F = stress per side, N

g = gravitational acceleration, 9.81 m/s²

m = motor weight, kg

T_{\max} = maximum torque, Nm

A = lateral distance between the holes in the motor's feet, m.

Dimension A is given in the motor's dimension drawing in millimeters.

The foundation should be dimensioned to afford a sufficiently large resonance gap between the natural frequency of the installation and various interference frequencies.

Foundation studs

The motor should be secured with foundation studs or a base plate. Motors for belt drives should be mounted on slide rails.

The foundation studs are bolted to the feet of the motor once locating pins have been inserted in the holes reamed for the purpose. The studs must be fitted to the correct feet with a 1 - 2 mm shim between the stud and the feet; see the markings on the studs and on the stator feet. Place the motor on the foundation and align the coupling. Use a spirit or laser level to verify that the shaft is horizontal. The height of the stator frame can be adjusted by setting either screws or shims. When you are sure the alignment is correct, grout the blocks.

7.7 Coupling alignment

Motors must always be aligned accurately. This is particularly important in the case of directly coupled motors. Incorrect alignment can lead to bearing failure, vibration, and even shaft fracture. In the event of bearing failure or if vibration is detected, the alignment should be checked immediately.

The best way of achieving proper alignment is to mount a pair of dial gauges as shown (page 100). Each gauge is on a coupling half, and they indicate the difference between the coupling halves both axially and radially. Slowly rotating the shafts while observing the gauge readings gives an indication of the adjustment that need to be made. The coupling halves must be loosely bolted together so that they can easily follow each other when turned.

To determine whether the shafts are parallel, measure with a feeler gauge the distance between the outer edges of the coupling halves at a point on the periphery: see Figure 7.2. Then turn both halves together through 90° without changing the relative positions of the shafts, and measure again at exactly the same point. Measure the distance again after rotating 180° and 270°. For typical coupling sizes, the difference between the highest and lowest readings must not exceed 0.05 mm.

To check that the shaft centers are directly opposite each other, place a steel ruler parallel with the shafts on the turned periphery of one coupling half and then measure the clearance between the periphery of the other half and the ruler in four positions as a parallelism check. The difference between the highest and lowest readings must not exceed 0.05 mm.

When aligning a motor with a machine whose frame reaches another temperature than the motor itself in normal service, allowance must be made for the difference in shaft height resulting from different thermal expansion. For the motor, the increase in height is about 0.03 % from ambient temperature to operating temperature at full output. Mounting instructions from manufacturers of pumps, gear units etc. often state the vertical and lateral displacement of the shaft at operating temperature. Bear in mind the effects of thermal expansion to avoid vibration and other problems in service.

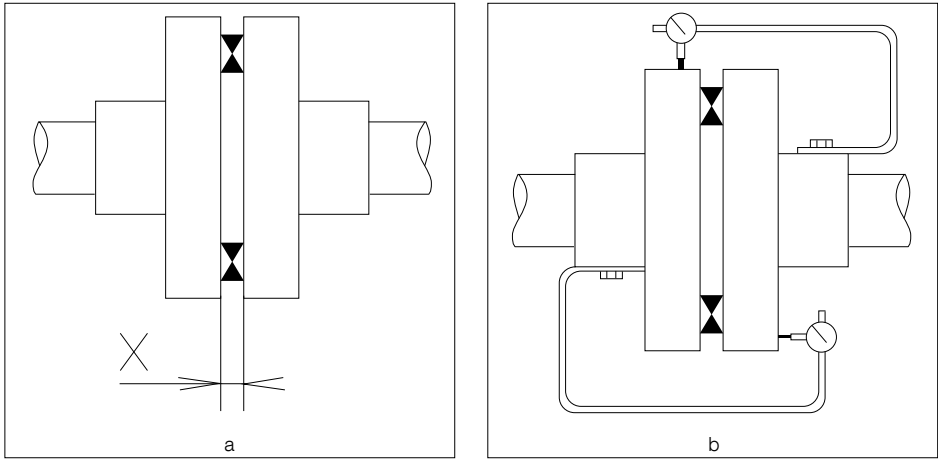

Figure 7.2 Angular deviation and motor alignment

7.7.1 Mounting pulleys and coupling halves

Care must be taken when fitting pulleys and coupling halves to prevent damage to bearings. They must never be forced in place or levered out. The pulleys and coupling halves with interference fit are heated before installation. The heating of the pulley or coupling half can be done with an induction heater or a gas torch, or in an oven.

A coupling half or pulley with a sliding fit can be pushed onto the shaft by hand for about half the length of the shaft extension. A special tool or fully-threaded bolt, a nut and two flat pieces of metal are then used to push the coupling half or pulley fully home against the shoulder of the shaft.

7.8 Slide rails

Motors for belt drives should be mounted on slide rails as shown in Figure 7.3. Place slide rails horizontally on the same level. Then position the motor and slide rails on the foundation and align them so that the middle of the motor pulley coincides with the middle of the pulley on the driven machine. Check that the motor shaft is in parallel with the drive shaft, and tension the belt in accordance with supplier instructions. Do not exceed the maximum belt forces (radial bearing loads) stated in the product catalog. The slide rail nearest the belt must be positioned so that the tensioning screw is between the motor and driven machine. The screw on the other slide rail must be on the other side. After alignment, grout in the slide rail fixing bolts.



WARNING

Do not over-tension the belts. Excessive belt tension can damage bearings and cause shaft fracture.

Positions of slide rails for belt drive.

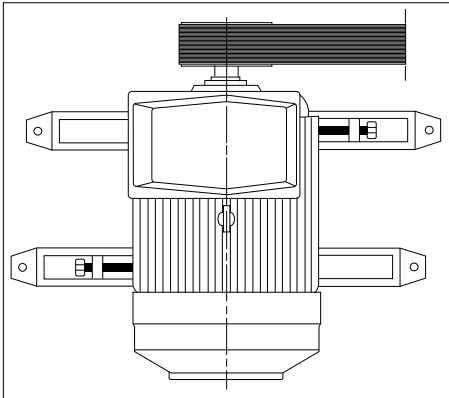

With belt drive the shafts must be parallel and the pulleys must be in line.

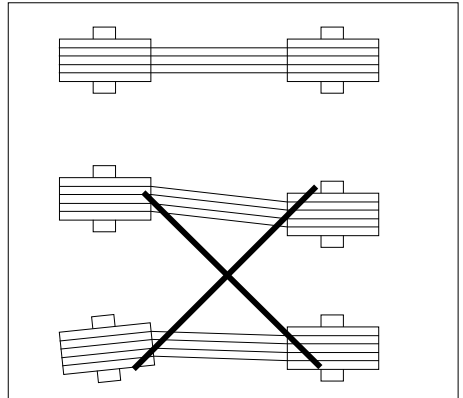

Figure 7.3 Attaching slide rails

7.9 Mounting bearings

Always take special care with bearings. Bearings should be fitted by heating or with purpose-made tools and removed with pullers. The maximum heating temperature is 100 °C. Detailed information can be obtained from the bearing supplier.

When a bearing is mounted on the motor shaft, cold or hot mounting may be used. Cold mounting is only suitable for small bearings and bearings that do not have to be pressed far onto the shaft. For hot mounting and where the bearing is shrink-fitted on the shaft, the bearing is first heated in an oil bath or with a special heater. It is then pressed onto the shaft with a mounting sleeve that fits the inner ring of the bearing. Grease-filled bearings, which usually have sealing plates or shield plates, should not be heated.

7.10 Lubrication

Reliability is a key driver in bearing design and in bearing lubrication systems. That is why ABB, as standard, follows the L_1 -principle: 99 per cent of motors will make the interval time). The lubrication intervals can also be calculated according to the L_{10} principle, which means that 90 per cent of motors will make the interval time. L_{10} -values, which are normally doubled compared to L_1 -values, are available from ABB at request.

Motors with permanently greased bearings

Motors up to frame size 250 are normally fitted with permanently greased bearings of type Z or 2Z. Process performance motors are normally provided with grease nipples.

Guidelines for bearing lifetime

- 4-pole motors: 20,000 – 40,000 duty hours¹⁾
- 2 and 2/4-pole motors: 10,000 – 20,000 duty hours¹⁾
- Shorter intervals apply to larger motors.

¹⁾ Depending on the application and load conditions

Motors with a lubrication system

Lubricate the motor when operational. If a grease outlet plug is fitted, remove it temporarily when lubricating, or remove permanently with auto-lubrication. If the motor is fitted with a lubrication plate, use the values shown on the plate; otherwise lubricate according to the L_1 -principle.

7.11 Fuse rating

The following table is a guideline for selecting a fuse and a switch-fuse for a motor connected direct on line in a 400 V, 50 Hz network.

P kW	I _N (A) per motor's rotation speed				Switch- fuse	Standard fuse
	750	1000	1500	3000		
0.09	0.53	-	-	-	OS 32 D12	2aM
0.12	0.63	0.59	-	-	OS 32 D12	2aM
0.18	0.90	0.75	0.72	-	OS 32 D12	2aM
0.25	1.18	0.92	0.83	0.70	OS 32 D12	2aM
0.37	1.6	1.25	1.12	0.93	OS 32 D12	2aM
0.55	2.4	1.78	1.45	1.33	OS 32 D12	2aM
0.75	2.7	2.4	1.9	1.7	OS 32 D12	4aM
1.1	3.35	3.3	2.55	2.4	OS 32 D12	4aM
1.5	4.5	4.1	3.4	3.3	OS 32 D12	6aM
2.2	5.9	5.4	4.8	4.5	OS 32 D12	10aM
3.0	7.8	6.9	6.5	6.0	OS 32 D12	10aM
4.0	10.0	8.7	8.6	7.4	OS 32 D12	16aM
5.5	13.4	11.9	11.1	10.5	OS 32 D12	16aM
7.5	18.1	15.4	14.8	13.9	OS 32 D12	20aM
11	25	23	22	20	OS 32 D12	32aM
15	29	31	29	27	OS 63 D12	40aM
18.5	36	36	37	33	OS 63 D12	50aM
22	45	43	42	40	OS 63 D12	63aM
30	60	59	56	53	OS 125 D12	80aM
37	74	69	68	64	OS 125 D12	100aM
45	90	82	83	79	OS 125 D12	125aM
55	104	101	98	95	OS 250 D03P	160aM
75	140	140	135	131	OS 250 D03P	200aM
90	167	163	158	152	OS 250 D03P	200aM
110	202	199	193	194	OS 400 D03P	250aM
132	250	238	232	228	OS 400 D03P	315aM
160	305	280	282	269	OS 630 D03P	355aM
200	395	355	349	334	OS 630 D03P	500aM
250	470	450	430	410	OS 630 D03P	630aM
315	605	565	545	510	OS 800 D03P	800aM
355	680	635	610	580	OS 800 D03P	800aM

Table 7.2 Fuse rating table

8. The SI system

8.	The SI system	100
8.1	Quantities und units	101
8.2	Prefixes	102
8.3	Conversion factors	103

The SI system

This section explains some of the units in the International System of Units (SI) that are used in conjunction with electric motors and their application.

A distinction is made between quantity, quantity value, unit, measurement number and between the name and symbol of a unit. These distinctions are explained in the following example.

Example: $P = 5.4 \text{ W}$, i.e. the power is 5.4 watts, where:

Quantity name = power

Quantity symbol = P

Quantity value = 5.4 watts

Unit name = watt

Unit symbol = W

Numerical value = 5.4

The SI system

8.1 Quantities and units

Quantity Name	Symbol	Unit Name	Symbol	Remarks
Space and time				
Plane angle	$\alpha \beta \gamma$	Radian	rad	
		Degree	\dots°	$1^\circ = \pi/180 \text{ rad}$
		Minute	\dots'	
		Second	\dots''	
Length	l	Meter	m	
Area	A	Square meter	m ²	
Volume	V	Cubic meter	m ³	
		Litre	l	
Time	t	Second	s	
		Minute	min	
		Hour	h	
Frequency	f	Hertz	Hz	
Velocity	v	Meter per second	m/s	km/h is the commonest multiple
Acceleration	a	Meter per second squared	m/s ²	
		Free fall acceleration	g	Meter per second squared
Energy				
Active	W	Joule	J	1 J = 1 Ws = 1 Nm
Watt second	Ws			
Watt hour	Wh			
Reactive	Wq	Var second	vars	
		Var hour	varh	
Apparent	Ws	Volt-ampere second	VA s	
		Volt-ampere hour	VAh	
Power				
Active	P	Watt	W	1 kW = 1.34hp ¹⁾ = 102 kpm/s = s = 10 ³ Nm/s = 10 ³ J/s
Reactive	Q, Pq	Var	var	
Apparent	S, Ps	Volt-ampere	VA	

¹⁾ kW = 1.34 hp (UK, US) is used in IEC Publ 72

1 kW = 1.36 hp (metric horsepower)

Quantity Name	Symbol	Unit Name	Symbol	Remarks
Mechanical				
Mass	m	Kilogram	kg	
		Tonne	t	
Density	ρ	Kilogram per cubic meter	kg/m ³	
Force	F	Newton	N	1 N = 0.105 kp
Moment of force	M	Newton-meter	Nm	1 Nm = 0.105 kpm = 1 Ws
Moment of inertia	J	Kilogram-meter	kgm ²	J = G x D ²
Pressure	p	Pascal	Pa	1 Pa = 1 N/m ²
		Newton per square meter	N/m ²	1 N/m ² = 0.102 kp/m ² = 10-5 bar
		Bar	bar	1 bar = 105 N/m ²
Heat				
Thermodynamic temperature	T, θ	Kelvin	K	Old name: absolute temperature
Celsius temperature	ϑ, t	Degree Celsius	°C	0 °C = 273.15 K
Temperature	$\Delta T, \Delta \vartheta$	Kelvin	K	The interval 1 K is identical to difference the interval 1 °C
		Degree Celsius	°C	
Thermal energy	Q	Joule	J	
Electricity				
Electric potential	V	Volt	V	1 V = 1 W/A
Electric voltage	U	Volt	V	
Electric current	I	Ampere	A	
Capacitance	C	Farad	F	1 F = 1 C/V
Reactance	X	Ohm	Ω	
Resistance	R	Ohm	Ω	1 Ω = 1 V/A
Impedance	Z	Ohm	Ω	$Z = \sqrt{R^2 + X^2}$

8.2 Prefixes

Multiples of SI units are indicated by the following prefixes. The use of prefixes in brackets should be avoided because they not generally well-known.

10 ³	kilo	k	(10 ⁻²)	(centi)	(c)	10 ⁻¹²	pico	p
(10 ²)	(hecto)	(h)	10 ⁻³	milli	m	10 ⁻¹⁵	femto	f
(10 ¹)	(deca)	(da)	10 ⁻⁶	micro	μ	10 ⁻¹⁸	atto	a
(10 ⁻¹)	(deci)	(d)	10 ⁻⁹	nano	n			

8.3 Conversion factors

The units generally used for technical applications are SI units.

However, other units may be encountered in descriptions, drawings, etc., especially where the inch system is involved.

Note that the US gallon and the UK gallon are not the same. To avoid confusion it is advisable to use the abbreviation 'US' or 'UK' after the unit. The following table lists some of most commonly needed conversion factors.

Length

1 nm = 1.852 km	1 km = 0.540 nm
1 mile = 1.609344 km	1 km = 0.621 mile
1 yd = 0.9144 m	1 m = 1.09 yd
1 ft = 0.3048 m	1 m = 3.28 ft
1 in = 25.4 mm	1 mm = 0.039 in

Velocity

1 knot = 1.852 km/h	1 km/h = 0.540 knot
1 m/s = 3.6 km/h	1 km/h = 0.278 m/s
1 mile/h = 1.61 km/h	1 km/h = 0.622 mile/h

Area

1 acre = 0.405 ha	1 ha = 2.471 acre
1 ft ² = 0.0929 m ²	1 m ² = 10.8 ft ²
1 in ² = 6.45 cm ²	1 cm ² = 0.155 in ²

Volume

1 ft ³ = 0.0283 m ³	1 m ³ = 36.3 ft ³
1 in ³ = 16.4 cm ³	1 cm ³ = 0.0610 in ³
1 gallon (UK) = 4.55 l	1 l = 0.220 gallon (UK)
1 gallon (US) = 3.79 l	1 l = 0.264 gallon (US)
1 pint = 0.568 l	1 l = 1.76 pint

Flow

1 m ³ /h = 0.278 x 10 ⁻³ m ³ /s	1 m ³ /s = 3600 m ³ /h
1 cfm = 0.472 x 10 ⁻³ m ³ /s	1 m ³ /s = 2120 cfm

Mass

1 lb = 0.454 kg	1 kg = 2.20 lb
1 oz = 28.3 g	1 g = 0.0352 oz

Comparison table for temperatures

°F	°C
0	-17.8
10	-12.2
20	-6.7
30	-1.1
32	0
40	4.4

Force

1 kp = 9.80665 N	1 N = 0.105 kp
1 lbf = 4.45 N	1 N = 0.225 lbf

Pressure

1 mm vp = 9.81 Pa	1 Pa = 0.102 mm vp
1 kp/cm ² = 98.0665 kPa	1 kPa = 0.0102 kp/cm ²
1 kp/cm ² = 0.980665 bar	1 bar = 1.02 kp/m ²
1 atm = 101.325 kPa	1 kPa = 0.00987 atm
1 lbf/in ² = 6.89 kPa	1 kPa = 0.145 lbf/in ²

Energy

1 kpm = 9.80665 J	1 J = 0.102 kpm
1 cal = 4.1868 J	1 J = 0.239 cal
1 kWh = 3.6 MJ	1 MJ = 0.278 kWh

Power

1 hp = 0.736 kW	1 kW = 1.36 hp
1 hp (UK, US) = 0.746 kW	1 kW = 1.34 hp (UK, US)
1 kcal/h = 1.16 W	1 W = 0.860 kcal/h

Temperature

0 °C	= 32 °F
°C	= 5/9 (°F - 32)
0 °F	= -17.8 °C
°F	= 9/5 (°C + 32)

Comparison table for temperatures

°F	°C
50	9.9
60	15.5
70	21.0
80	23.6
90	32.1
100	37.8

9. Ordering

9.	Ordering	108
9.1	Selecting a motor	109
9.2	Online tools	111
9.2.1	Optimizer	111
9.2.2	DriveSize and MotSize	112
9.3	Loading (kW)	112
9.4	Speed	113
9.5	Starting the motor	113
9.6	Operating environment	114
9.7	Ordering and order check list	114

Ordering

ABB's sales force plays a key role in defining the right product with the customer and communicating the customer order towards production units. The order specifications are initially defined at the offering phase, but will often be more accurate, or even changed, when placing the actual order. For the production units to deliver motors according to the customers' specifications and needs, it is important that all information stated in the order is correct, and no relevant information is missing.

This chapter explains how to select a motor and what tools there are to help in selection. Requirements for making a valid order are also introduced.

Ordering

9.1 Selecting a motor

There are three fundamental variables to consider when selecting a motor:

- electricity supply to which the motor will be connected
- type of enclosure or housing of the motor (IP class)
- starting method (see Electrical design)

Network voltage and frequency vary between regions and countries of the world. What is more, industries and applications may require voltages that are unrelated to the country where the motor is used or purchased, whereas frequency is usually region-specific. The table presents network voltages and frequencies in a number of selected countries and regions of the world. The voltages shown here are the most commonly available; be sure to verify the exact required voltage per each customer case.

Area/country	Voltage V	Frequency Hz
Europe		
EU	220, 230, 400 , 500, 690	50
Russia	220, 380	50
Africa		
Africa, majority of	220, 380 , 400 , 415	50
South Africa	220, 230, 380, 400 , 500	50
Middle East		
Israel	220,230, 280, 400 , 415	50
Saudi Arabia	220, 230, 380, 400, 440	50, 60
India	220, 230, 400, 415	50
North America		
Canada	230, 460, 575, 600	60
United States	230, 460, 480	60
Mexico	220, 480	60
Central America		
Cuba	220, 440	60
Costa Rica	240, 440	60
South America		
Brazil	220, 380, 440	60
Chile	220, 380 , 400, 500	50, 60
Argentina	220, 380 , 440	50
Northeast Asia		
China	380 , 400	50
Japan	200, 220, 400, 440	50, 60
South Korea	220, 380, 440	60
Southeast Asia		
Philippines	115, 380, 440	60
Malaysia	240, 415	50
Indonesia	220, 380, 400	50
Oceania		
New Zealand	230, 240, 400, 415	50
Australia	230, 240, 415 , 440	50

Table 9.1. World network voltages and frequencies

Type of enclosure

There are two frame material options available: totally enclosed aluminum and cast-iron motor frames.

The totally enclosed fan-cooled (TEFC, which equals 'IP55 and IC411') motor is the predominant standard for industrial applications today. The versatile TEFC is a totally enclosed construction, with cooling air directed over the frame by a shaft-mounted fan.

9.2 Online tools

9.2.1 Optimizer

Optimizer is an easy-to-use online tool that helps you select the optimal motor according to the requirements of the region-specific minimum energy performance standard (MEPS). After selecting the region where the motor will be used, Optimizer shows default voltage, frequency, and other options. Further, motors can be compared in terms of running cost, lifecycle saving, and emission reduction. Optimizer also provides all the documentation related to the product.

Optimizer
Select, compare running costs and find documentation for low voltage motors

ABB Power and productivity for a better world™ | [Contact us](#)

Find motors

MEPS (Required) ? EU - MEPS > Efficiency class IE2 > Frame material Select frame material > Motor range Select motor range >

Voltage 400V > Frequency 50Hz > Speed Select poles > Output Select output (KW) > **RESET FILTERS**

Find by product code or motor type
Product code / motor type
e.g. M5BP280SMA / 3GBP282210
Input the product code to quickly find the motor you are looking for.

Output	Volt./Hz	Eff. class	Type	Speed	Motor range	Data	Frame material
0.75kW	400V 50Hz	IE2	M2AA 80 B 2	2	General Performance Motors	View data	Aluminum ADD
0.75kW	400V 50Hz	IE2	M2AA 80 D 4	4	General Performance Motors	View data	Aluminum ADD
0.75kW	400V 50Hz	IE2	M2AA 90 LB 6	6	General Performance Motors	View data	Aluminum ADD
0.75kW	400V 50Hz	IE2	M2AAD 80 A 2	2	Dust Ignition Proof Motors	View data	Aluminum ADD
0.75kW	400V 50Hz	IE2	M2AAD 80 B 2	2	Dust Ignition Proof Motors	View data	Aluminum ADD
0.75kW	400V 50Hz	IE2	M2AAD 80 D 4	4	Dust Ignition Proof Motors	View data	Aluminum ADD

Displaying 1-100 out of 812 motors. [1](#) [2](#) [3](#) [4](#) [5](#) [6](#) [7](#) >

My motors

Cost of running **+**

Documentation **+**

Summary and export **+**

Figure 9.1. Optimizer selection window

9.2.2 DriveSize and MotSize

DriveSize and MotSize are software programs for selecting and dimensioning an optimal low voltage motor, frequency converter and transformer, particularly in cases where motor requirements fall outside of those presented in the motor catalog. DriveSize and MotSize can also be used to compute network harmonics and to print out dimensioning information. The programs contain current versions of our motor and frequency converter catalogs. Both tools are downloadable on ABB's web pages.

9.3 Loading (kW)

Loading of the motor is determined by the equipment driven and the torque available on the shaft.

IEC electric motors have standard outputs per frame size. See Standards, Output power and frame size correlation for detailed information about how the standard determines power and frame size combinations.

9.4 Speed

The induction motor is a fixed single-speed machine. Its speed depends on the frequency of the electricity supply and the stator winding design.

No-load speed is slightly lower than synchronous speed due to no-load losses in the machine. Further, full-load speed is typically 3 - 4 per cent lower than no-load speed.

$$\text{Synchronous speed r/min} = \text{Frequency} \times 120 / \text{number of poles}$$

Number of poles	50 Hz speed r/min		60 Hz speed r/min	
	Synchronous	Typical full load	Synchronous	Typical full load
2	3000	2900	3600	3450
4	1500	1440	1800	1740
6	1000	960	1200	1150
8	750	720	900	850
10	600	580	720	700
12	500	480	600	580
16	375	360	450	430

Table 9.2. Motor speeds

9.5 Starting the motor

The available motor torque and load torque sometimes vary with rotation speed. The resulting accelerating torque in a certain moment of time depends on speed. The starting method is an important criterium in selecting a motor and must be carefully analyzed.

Between starting speed and nominal speed it must be ensured that even under unfavorable conditions (such as low voltage on motor terminals) the motor torque is always sufficiently high above the highest possible load torque. This has to be taken in account when selecting the starting method.

Further, in case of high starting frequency or heavy starting, overheating and its consequences must be taken into account.

9.6 Operating environment

The operating environment of the motor is another important factor to consider when ordering, because ambient temperature, humidity, and altitude can all affect performance.

Having an IP55 motor does not mean that it will remain tight in any outdoor operating conditions. The application where the motor is used, mounting position and actual exposure to external factors need to be taken into account. For example, ambient temperatures above 40 °C or altitudes above 1000 m mean reduced loadability. Similarly, mounting on the ceiling means that non-standard drain holes need to be ordered.

All metals corrode with varying intensity under the influence of chemicals and humidity. For example, pure aluminum and most of its alloys, without special surface treatment, are very sensitive to salt water. On the other hand, cast iron as such is durable against many chemicals except for the machined parts like drilling holes or centering borders. Selecting the right surface treatment will help lengthen the life of the motor and reduce the need for maintenance. See Mechanical Design, Surface treatment for further information.

9.7 Ordering and order check list

The following things must be known when placing a customer order:

- motor type, supply voltage and frequency, and product code
- mounting position
- variant codes for options in motor design or appliances, such as:
 - cable flanges and other connection parts, unless standard
 - special insulation and insulated bearings, unless standard
- duty type and ambient conditions
- rating values
- number of motors ordered
- price, delivery time, and delivery address
- quotation reference number

Order management system (OMS) is a complete order management and logistics system for low and high voltage motors, and it is used by ABB's production units, It is often possible to deliver special features if they are based on the actual offer. If there is no variant code for a desired feature, you may check the availability, price and delivery time of the said feature through ABB sales personnel.

10. Variable speed drives

10.	Variable speed drives	116
10.1	Types of drives	117
10.2	Pulse width modulation (PWM)	118
10.3	Dimensioning the drive	118
10.4	Loadability (torque)	120
10.4.1	Improving loadability	121
10.5	Insulation level	122
10.6	Earthing	122
10.7	Operation at maximum speed	123
10.8	Balancing	125
10.9	Critical speeds	125
10.10	Shaft seals	125
10.11	Low speed operation	126

Variable speed drives

Squirrel cage induction motors offer excellent availability, reliability and efficiency. However, they have two weaknesses: high starting current and lack of smooth speed control over a wide speed range. A motor supplied by a variable speed drive (VSD) - also called frequency converter – usually solves both problems. A VSD-driven motor can be started softly with low starting current, and speed can be controlled and adjusted smoothly according to the application over a wide speed range.

The benefits of VSDs are widely recognized: optimal speed and control accuracy; reduced maintenance thanks to lower running speeds; higher production quality. Accordingly, there is a large number of VSD applications on the market, and approximately one half of new motor installations include a VSD.

Variable speed drives

10.1 Types of drives

Variable speed drives are power electronic devices which convert fixed input voltage, AC or DC, into variable voltage and frequency on the output side. The application determines whether a direct or indirect converter is used.

Converter

A converter is a variable speed drive converting fixed AC supply to variable voltage and frequency. It consists of four main parts: rectifier, DC circuit, inverter unit, and control unit. Converters are connected to an AC supply.

Inverter

An inverter is a variable speed drive converting fixed DC supply to variable AC voltage and frequency. It consists of two main parts: inverter unit and control unit. Inverters are connected to a DC source and are sometimes called common DC bus drives.

Direct converter

Direct converters such as cycloconverters and matrix converters change the input voltage and frequency directly to output without intermediate DC links. Cycloconverters are used in high-power (megawatt-level) applications and at low frequencies.

Indirect converters

Indirect converters are either current source or voltage source converters.

In a voltage source converter (VSC), the most common converter topology in low voltage applications, the intermediate link acts as a DC voltage source, and its output consists of controlled voltage pulses at continuously varying frequency. The pulses are fed to the different phases of a three-phase system. This enables stepless speed control of the motor.

In a current source converter (CSC), the DC link acts as a DC current source, and its output is a current pulse or a current pulse sequence.

10.2 Pulse width modulation (PWM)

ABB low voltage VSC variable speed drives use pulse width modulation (PWM) with variable switching frequency, which best meets the majority of requirements. The used control method, such as direct torque control (DTC), vector control, or scalar control, depends on the product and application.

In a PWM drive, the rectifier converts the input line power, which has a nominally fixed voltage and frequency, into fixed DC voltage. This fixed DC voltage is then filtered to reduce the ripple voltage resulting from the rectification of the AC line. The inverter then changes the fixed DC voltage into AC output power with adjustable voltage and frequency.

10.3 Dimensioning the drive

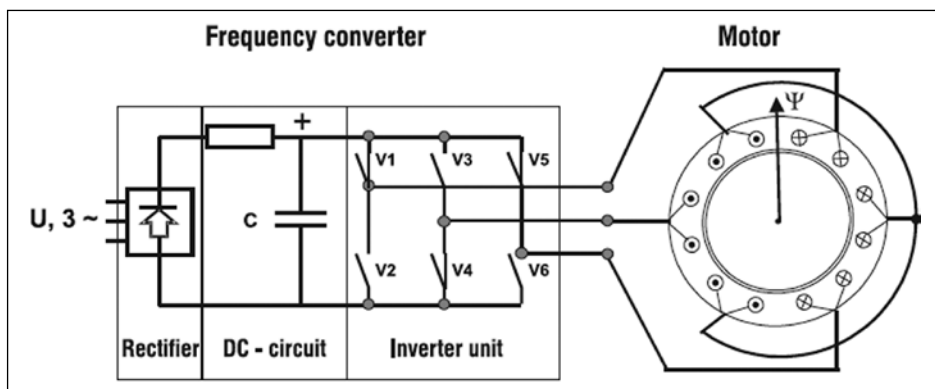

Figure 10.1 The working principle of a VSD-driven motor

DriveSize, a complete dimensioning tool for drives and motors, can be downloaded from www.abb.com/motors&generators. The following is a brief explanation about motor and converter selection with the DriveSize software.

Motor selection

The actual load torque should be below the reference loadability curve (or load capacity curve) of the selected motor and converter combination (see Figure 10.2 in Section 10.4). However, if the motor operation is not continuous in all duty points of the speed range, the load curve may exceed the reference curve. In this case, special dimensioning is required.

Further, the maximum torque of the motor must be at least 40 percent higher than the load torque at any frequency, and the maximum permissible speed of the motor must not be exceeded.

Motor design

Converters with different working principles, modulation patterns and switching frequencies give different performances for the same motor. As performance and behavior are also dependent on motor design and construction, motors of the same size and output power but different design may behave very differently with the same converter. Therefore, the selection and dimensioning instructions are product-specific.

Converter selection

The converter should be selected according to the nominal power P_N and rated current of the motor. Sufficient current margin should be reserved for controlling and managing dynamic situations.

10.4 Loadability (torque)

Both theoretical calculations and laboratory tests show that the continuous maximum load (torque) of a converter-driven motor mainly depends on the modulation pattern and switching frequency of the converter, but also on the design of the motor. The graph below is a guideline for motor selection.

These curves present the maximum continuous load torque of the motor as a function of frequency (speed) to match the temperature rise of the rated sinusoidal voltage supply at nominal frequency and full rated load.

ABB motors are usually designed to fall within temperature rise class B. Process performance motors (unlike motors for hazardous areas), for example, can in such cases be dimensioned either according to temperature rise class B curve, or temperature rise class F curve, which provides higher loadability. If the product catalog indicates that class F temperature rise applies on sinusoidal supply, in frequency converter use the motor can only be dimensioned according to the temperature rise class B curve.

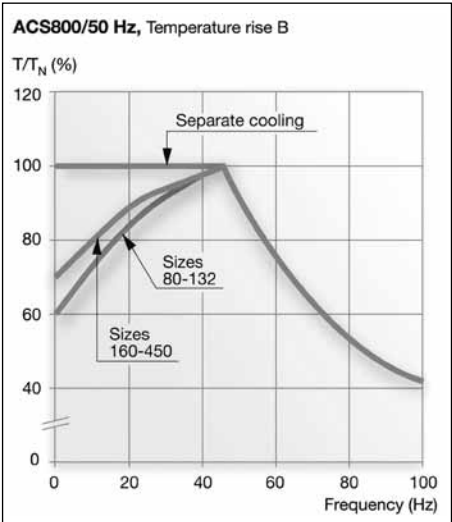

Figure 10.2. Reference curve for motor loadability with ABB's frequency converters (Process performance motors)

The following ABB motors can be used with frequency converters:

- Process performance motors (designed for demanding industrial applications)
- General performance aluminum and cast iron motors (for general applications)
- Motors for explosive atmospheres: flameproof, non-sparking, and dust ignition protection motors
- Note: special motors such as synchronous reluctance motors, high speed motors and permanent magnet motors are always VSD-driven. Some of these require motor-type specific drives software.

10.4.1 Improving loadability

The output torque of frequency-converter-driven motors is usually slightly reduced because of heating caused by harmonics and a decrease in cooling at reduced voltage and lower frequencies. However, the loadability of the motor can be improved with the following means.

More effective cooling

More effective cooling is achieved by mounting a separate constant-speed fan, which is especially beneficial at low speeds. Selecting optimal fan motor speed and fan design to deliver a stronger cooling effect than with a standard motor at nominal speed will give an improved cooling effect over the entire speed range.

Liquid cooling (water-cooled motors) is another very effective cooling method. In very demanding circumstances the bearing end shields must also be cooled, for example by adding cooling disks on the shaft.

Filtering

Filtering the converter output voltage reduces the harmonic content of the motor's voltage and current and therefore reduces the generation of additional losses in the motor. This reduces the need for derating. Full power of the drive and the speed range of the motor must be taken into account when dimensioning filters (additional reactance). However, filters may limit the maximum torque and speed of the motor. Filters also reduce electromagnetic noise, EMC, and voltage peaks.

10.5 Insulation level

In a frequency converter the output voltage (or current) most often is a voltage (current) pulse or a pattern of pulses. Depending on the type of power components and the design of the power circuit, considerable overshoot may develop at the leading edge of a voltage pulse. This is why winding insulation level must always be checked in product-specific guidelines. The basic rules for standard applications are:

- If the nominal voltage of the supply network is max. 500 V, no insulation strengthening is required for standard ABB induction motors.
- If the nominal network voltage is from 501 up to 600 V, special motor insulation **or** dU/dt-filters are required.
- If the nominal network voltage is from 601 up to 690 V, special motor insulation **and** dU/dt-filters are required.
- If the nominal network voltage is from 601 up to 690 V **and** the motor's supply cables are longer than 150 meters, special motor insulation is required.

Exact product specific guidelines can be found in ABB product catalogs.

10.6 Earthing

In converter usage, special attention must be paid to earthing arrangements to ensure:

- Proper action of all protective devices and relays for general safety
- Minimal or acceptable electromagnetic interference
- An acceptable level of bearing voltages to avoid bearing currents and bearing failures

ABB recommends using symmetrical shielded cables with cable glands providing a 360-degree connection (so-called EMC glands).

10.7 Operation at maximum speed

In converter usage, the actual speed of the motor may deviate considerably from its nominal speed. In operation at higher speeds, the maximum permissible speed of the motor type and the critical speed of the entire equipment must not be exceeded.

When the motor is run at higher than nominal speed, maximum torque and bearing construction should also be checked. Notice that if a standard fan is used, also friction and cooling losses as well as the noise level will increase.

Maximum torque

In the field weakening area the voltage of the motor is constant, but motor flux and capability to produce torque reduce approximately in square of the frequency after the field weakening point (the point after which output voltage remains constant even though the output frequency increases). At the highest speed point, or at any other duty point in the field weakening area, the maximum (breakdown) torque must at least 40 percent higher than the load than the load torque to avoid excessive rotor heating.

If filters or additional reactances are used between the converter and motor, the voltage drop from the fundamental voltage with full load current must be taken into account.

Bearing construction

There is a limit to the speed at which rolling bearings can be operated. Bearing type and size, design, load, lubrication and cooling conditions as well as cage design, accuracy and internal clearance all influence the permissible maximum speed.

Lubrication

In general, the lubrication intervals are affected by the operating and ambient temperatures with respect to the lubricant and bearing component. Changing the bearings and/or lubricant may enable higher speeds. However, if this is done, the correct combination should be verified with ABB.

Frame size	Speed r/min	
	2-pole motor	4-pole motor
71 - 80	6000	4500
90 - 100	6000	6000
112 - 200	4500	4500
225 - 250	3600	3600
280	3600	2600
315	3600	2300
355	3600	2000
400	3600	1800
450	3000	1800

Table 10.1 Maximum speeds of Process performance motors

The sheer strength of the lubricant is determined by its base oil viscosity and thickener, which in turn determines the permissible operating speed for the particular bearing. The maximum speed can be increased by using high speed greases or oil lubrication. Very accurate relubrication with small quantities also reduces bearing friction and heat generation.

Fan noise

Fan noise increases with the speed of the motor and usually becomes dominant at 50 Hz for 2- and 4-pole motors. If the speed further increases, the noise level will also increase. The noise level increase can be calculated approximately with the following formula:

$$\Delta L_{sp} = 60 \times \log \frac{n_2}{n_1} \text{ dB(A)}$$

where ΔL_{sp} = increase of the sound pressure level when speed changes from n_1 to n_2 .

Fan noise is typically 'white noise', which means that it contains all frequencies within the audible frequency range.

Fan noise can be reduced by either:

- Replacing the fan (and fan cover) with a reduced outer diameter fan
- Using a unidirectional fan
- Fitting a silencer

10.8 Balancing

The balancing accuracy and mechanical strength of all rotating parts should be checked if the permissible maximum speed of the motor is exceeded. All other parts mounted on the motor shaft, such as coupling halves and pulleys must also be carefully balanced.

10.9 Critical speeds

The first critical speed of the whole drive system, or of its components should not be exceeded, and a safety margin of 25 percent should be allowed.

Also supercritical drive systems can be used, but those must be dimensioned on case-by-case basis.

10.10 Shaft seals

All rubbing shaft seals (V-rings, oil seals, etc.) have a recommended maximum speed limit. If this is below the proposed high-speed operation, non-rubbing labyrinth seals should be used.

10.11 Low speed operation

Lubrication

At very low speeds, the motor's ventilation fan loses its cooling capacity. If the operational temperature of the motor bearings is $\geq 80\text{ }^{\circ}\text{C}$, (check by measuring the surface temperature of the bearing end-shields), shorter relubrication intervals or special grease (Extreme Pressure (EP) grease or high temperature lubricant) should be used.

The re-lubrication interval should be halved for each $15\text{ }^{\circ}\text{C}$ increase in the bearing temperature above $+70\text{ }^{\circ}\text{C}$.

Cooling capacity of a fan

The air flow and cooling capacity depends on the fan speed. A separate constant-speed fan can be used to increase cooling capacity and motor loadability at low speeds. As the internal cooling is not affected by a separate outer fan, a small reduction in loadability is still necessary at very low speeds.

Electromagnetic noise

The harmonic components of frequency converter voltage increase the magnetic noise from the motor. The frequency range of these magnetic force waves can cause structural resonance in the motor, especially in steel-framed ones.

Magnetic noise can be reduced by:

- Increasing the switching frequency, giving higher order harmonics and lower amplitudes which are less disturbing to the human ear. On the other hand, setting to a high switching frequency may reduce the output current of the drive.
- Filtering the harmonic components at the converter output filter or in additional reactances
- Motor silencer

More information on noise reduction can be found in Chapter Noise.

Contact us

www.abb.com/motors&generators

We reserve the right to make technical changes or modify the contents of this document without prior notice. With regard to purchase orders, the agreed particulars shall prevail. ABB does not accept any responsibility what so ever for potential errors or possible lack of information in this document.

We reserve all rights in this document and in the subject matter and illustrations contained herein. Any reproduction, disclosure to third parties or utilization of its contents – in whole or in parts – is forbidden without prior written consent of ABB.

© Copyright 2014 ABB.
All rights reserved.

9AKK105285 EN 02-2014