



Power Chair

EW-M48 User Manual



TABLE OF CONTENTS

INTRODUCTION	1
IMPORTANT PRECAUTIONS	2
ELECTROMAGNETIC INTERFERENCE AND WARNINGS	3
SAFETY WARNING AND INSTRUCTION LABELS	5
IDENTIFICATION OF PARTS	6
OPERATING YOUR POWER CHAIR	8
GBK54030 LiX LE SYSTEM INSTALLATION	10
DISASSEMBLING / RE-ASSEMBLING YOUR POWER CHAIR ---	17
CHARGING THE BATTERIES	18
CARE AND MAINTENANCE	19
TROUBLE SHOOTING	20
TECHNICAL SPECIFICATIONS	21

INTRODUCTION

Thank you and congratulations on purchasing your new Ewheels Medical Power Chair.

It is designed to provide the transportation ability indoors and outdoors for person whose ability to walk is impaired, but who are still in terms of their eyesight and physically and mentally able to operate a Power Chair.

We pride ourselves on providing safe and comfortable products. Our goal is to ensure your complete satisfaction. We sincerely hope you enjoy your Ewheels Medical Power Chair.

Please read and observe all warnings and instructions provided in owner's manual before your operate the various functions of this Power Chair. Also, please retain this booklet for future reference.

If you have any questions, you can contact:

Ewheels Medical

1000 W Vista Bonita
Drive Suite B101
Phoenix, Arizona
85027, U.S.A



or your local dealer:

IMPORTANT PRECAUTIONS

- Only one person at a time can ride a Ewheels Medical Power Chair.
- Maximum load is 136 kg / 300 lbs.
- Turn off power before getting on or off your power chair.
- Always drive carefully with your feet on the footplate and be aware of others in your area.
- Always use pedestrian crossings wherever possible. Take extreme when care crossing roads.
- Do not drive on slopes exceeding 6 degrees, and take extreme care when turning on slopes.
- Do not use full power when turning to sharp corners.
- Take great care and drive in low speeds when backing up, riding downhill, or on uneven surfaces and climbing curb.
- The power chair may not operate well in high humidity.
- Never put your power chair in neutral when staying on slopes.
- Follow all traffic laws when riding in the vicinity of public roads.
- It is NOT recommended to use your power chair in wet environments as it may cause damage.

ELECTROMAGNETIC INTERFERENCE AND WARNINGS

CAUTION: It is very important that you read this information regarding the possible effects of Electromagnetic Interference on your power chair.

Powered wheelchairs and motorized scooters may be susceptible to electromagnetic interference (EMI), which is interfering electromagnetic energy (EM) emitted from sources such as radio stations, TV stations, amateur radio (HAM) transmitters, two-way radios, and cellular phones. The interference (from radio wave sources) can cause the motorized scooter to release its brakes, move by itself, or move in unintended directions. It can also permanently damage the motorized scooter control system. The intensity of the interfering EM energy can be measured in volts per meter (V/m). Each motorized scooter can resist EMI up to a certain intensity. This is called its "immunity level." The higher the immunity level, the greater the protection will be. At this time, current technology is capable of achieving at least a 20 V/m immunity level, which would provide useful protection from the more common sources of radiated EMI. The immunity level of this motorized scooter model is 20 V/m.

There are a number of sources of relatively intense electromagnetic fields in the everyday environment. Some of these sources are obvious and easy to avoid. Others are not apparent and exposure is unavoidable. However, we believe that by following the warnings listed below, your risk to EMI will be minimized.

The sources of radiated EMI can be broadly classified into three types :

1. Hand-held portable transceivers (transmitters-receivers) with the antenna mounted directly on the transmitting unit. Examples include: citizens band (CB) radios, "walkie talkie," security, fire, and police transceivers, cellular telephones, and other personal communication devices.



Some cellular telephones and similar devices transmit signals while they are ON, even when not being used.

2. Medium-range mobile transceivers, such as those used in police cars, fire trucks, ambulances, and taxis. These usually have the antenna mounted on the outside of the vehicle.
3. Long-range transmitters and transceivers such as commercial broadcast transmitters (radio and TV broadcast antenna towers) and amateur (HAM) radios.



Other types of hand-held devices, such as cordless phones, laptop computers, AM/FM radios, TV sets, CD players, and cassette players, and small appliances, such as electric shavers and hair dryers, so far as we know, are not likely to cause EMI problems to your motorized scooter.

Power Chair Electromagnetic Interference :

Because EM energy rapidly becomes more intense as one moves closer to the transmitting antenna (source), the EM fields from hand-held radio wave sources (transceivers) are of special concern. It is possible to unintentionally bring high levels of EM energy very close to the power chair control system while using these devices. This can affect power chair movement and braking. Therefore, the warnings listed below are recommended to prevent possible interference with the control system of the power chair.

Warnings :

Electromagnetic interference (EMI) from sources such as radio and TV stations, amateur radio (HAM) transmitters, two-way radios, and cellular phones can affect the power chair. Following the warnings listed below should reduce the chance of unintended brake release or power chair movement, which could result in serious injury.

1. Do not operate hand-held transceivers (transmitters-receivers), such as citizens band (CB) radios, or turn ON personal communication devices, such as cellular phones, while the power chair is turned ON;
2. Be aware of nearby transmitters, such as radio or TV stations, and try to avoid coming close to them;
3. If unintended movement or brake release occurs, turn the power chair OFF as soon as it is safe;
4. Be aware that adding accessories or components, or modifying the power chair, may make it more susceptible to EMI; and
5. Report all incidents of unintended movement or brake release to the distributor listed on the inside front cover of this manual. Note whether there is a source of EMI nearby.

Important Information

1. 20 volts per meter (V/m) is a generally achievable and useful immunity level against EMI (as of May 1994). The higher the level, the greater the protection.
2. The immunity level of this product is 20 V/m.



SAFETY WARNING AND INSTRUCTION LABELS



<p>1</p>	<p>Warning Sticker</p> <ol style="list-style-type: none"> 1. Please read the instruction booklet carefully before using your scooter. 2. Do not drive the scooter on slippery surfaces or on slopes over 6 degrees limit. 3. Do not drive on highway, crowded roads, or unfamiliar areas. 4. Do not turn at high speed in either forward or reverse. 5. Do no wash with water or leave scooter in humid environment since water can damage the electronic parts.
<p>2</p>	<p>Wiring diagram label</p>
<p>3</p>	<p>Left N-D Lever adjustment label which instructs freewheel mode operation.</p>
<p>4</p>	<p>Right N-D Lever adjustment label which instructs freewheel mode operation.</p>

IDENTIFICATION OF PARTS

Before attempting to drive this power chair on your own, it is important that you familiarize yourself with the controls and how they operate.



Figure 1 - EW-M48 Power Chair front View

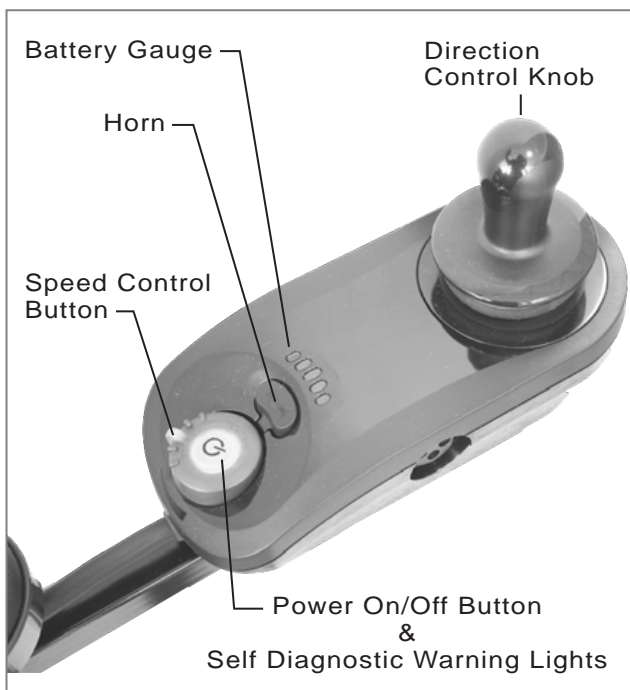

Figure 2 - EW-M48 Joystick

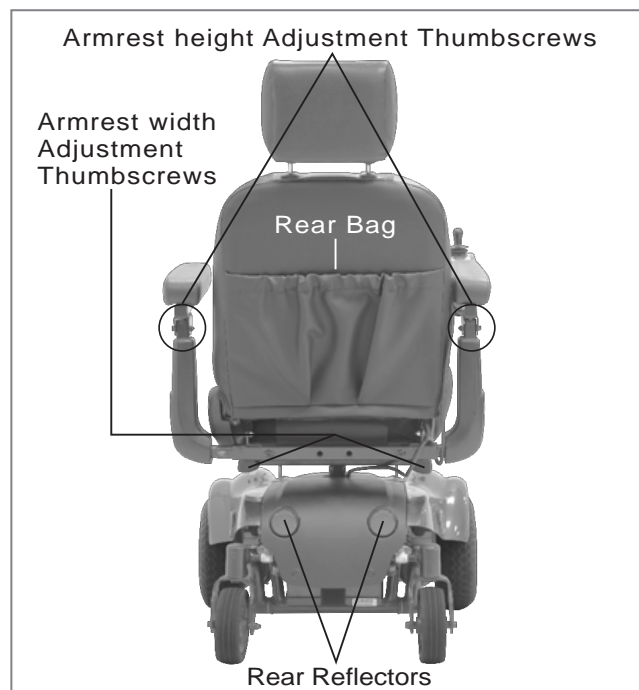

Figure 3 - EW-M48 Power Chair Rear View

JOYSTICK :

- Self Diagnostic Warning Lights

Flashing of lights indicates there is a problem within power chair. See page 16 for more information.

- Battery Gauge

There are eleven LED lights on joystick. When all LED lights are on, batteries are fully charged; The Battery Gauge is used to indicate power on and provides an estimate of the remaining battery capacity.

Any green LEDs lit indicate well charged batteries.

If only amber and red LEDs are lit, the batteries are moderately charged. Recharge before undertaking a long trip.

If only red LEDs are lit, the batteries are running out of charge. Recharge as soon as possible.

- Extendable Bracket

By releasing Knob (B) the joystick bracket (C) is able to extend and retract. With joystick retracted, this enables you to pull up to any table, and tighten knob (B), when adjusted to a comfortable position.

ARMREST :

- Armrest width & height Adjustment Thumbscrews

Loosen two thumbscrews to adjust armrest width & height tighten again to lock in desired position.

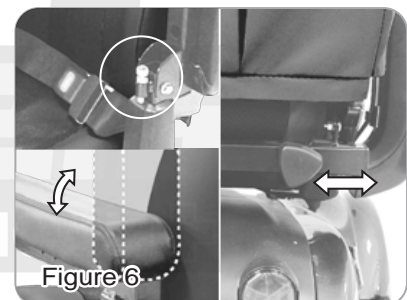
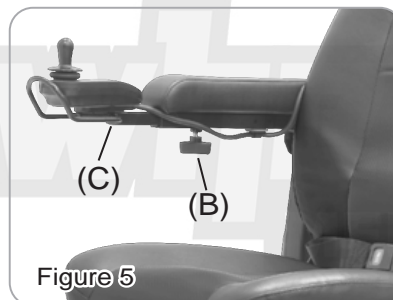
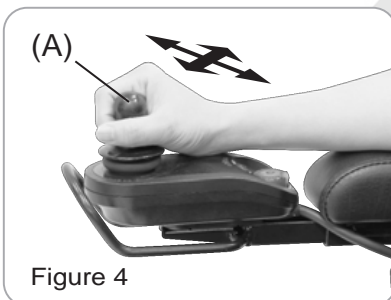
**FOOTPLATE :**

- Footplate

The footplate can be adjusted according to your specific needs. It can be width & adjusted vertically or horizontally. To adjust footplate, loosen screw and arrange height to desired position, then, tightened screw to secure plate in place. (D & E)

POWER BASE :

- Free-Wheeling Lever

When lever is in N (Neutral) position, power chair can be moved manually.

When lever is in D (Drive) position, power chair can be driven. Normal position is D.

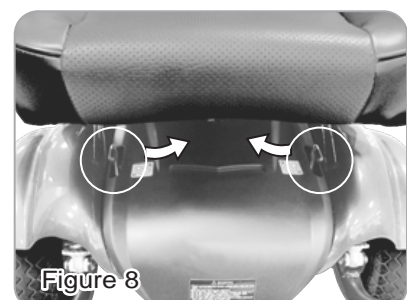
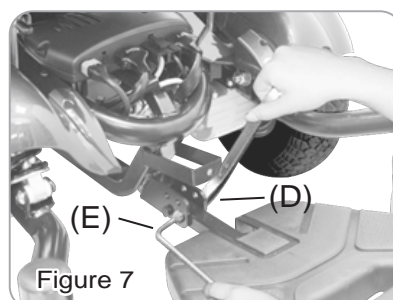

OPERATING YOUR SCOOTER

Before beginning your journey with your new power chair, make sure power chair is on a level surface and clear of any obstacle. Although your power chair is able to climb slopes, it is safer to practice on a leveled surface.

1. Before operating with your power chair, check the following:

- free-wheeling lever is on D.
- speed dial is at the lowest speed (fully turned counterclockwise).

2. Sit on chair and fasten seat belt.

3. When power is turned on, all battery gauge LED lights should be lit lighting. The self-diagnostic warning lights should not be blinking.

4. While resting your arm on armrests, joystick should be within reach. By pushing joystick slightly forward, power chair will move forward slowly, and pushing joystick fully forward, chair will move at normal speed. And adjusting speed dial will also decrease or increase speed. Also, with joystick, you are able to turn chair in 360°. When joystick is let go and back in center position, chair will stop.

5. Practice driving where there is no obstacle. Start at slowest speed and move forward and backward; make some turns. As you get more comfortable, you can increase the speed by turning speed dial knob clockwise.

Headrest Adjustment :

By pressing (k) to adjust the headrest (J) up & down to a comfortable position.

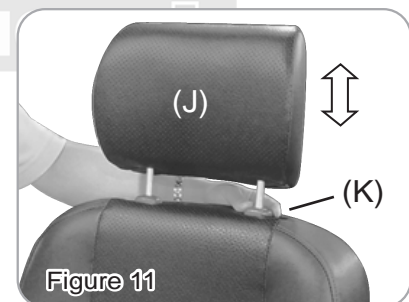
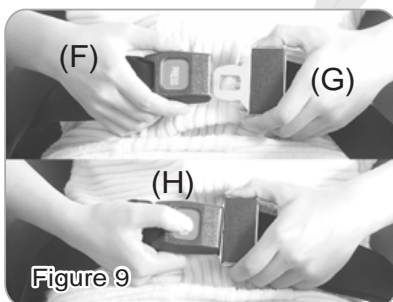

! While standing up, avoid stepping on footplate as it may cause injury.

Seat Adjustment :

By lifting up lever (L) to rotate seat (See Fig. 12)
Note: Do not swivel seat angle over 90 degrees, to prevent wires twist.

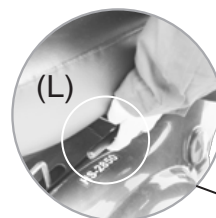

Keep in mind these rules :

- Use your power chair only where it is safe to walk.
- Drive in low speed when reversing, riding downhill on ramp or curb or on uneven surface.

Other Operating Information :

Hill climbing : You may need to use a higher speed. For a higher speed, turn speed dial clockwise.

Down slopes : Proceed with downward slope slowly, and turn speed dial counterclockwise. This enables good control when speed is set in slower motion. However, your power chair will not self accelerate down hills due to. automatic braking, taking effect should you attempt to drive too fast.

Curb climbing : Approach slowly from right angles to the curb. A direct approach is needed. Do not attempt greater than a 2" curb.

If Self-Diagnostic Warning Lights start to flash, identify problem from chart on page 10 and take action.

If power chair breaks down and must be moved, please follow below directions :

1. Get off power chair.
2. Push free-wheeling lever to N.
3. Move power chair slowly to a safe location.
4. Push free-wheeling lever back to D.





LiNX LE System Installation Manual
GBK54030 Issue 1.02

7/05/2013

1 Installation procedure

1. First read and fully understand this manual.
2. Mount all the electrical parts of the wheelchair system (motors, park brakes, batteries, Power Module, Remote) on the wheelchair. for the physical dimensions of the LiNX LE System Power Module, Remote and mounting rec-ommendations.
3. Do not connect any cables before all the parts of the electrical system are mounted.
4. Connect the LiNX LE System Power Module to the motors the park brakes and the Remote.
5. Connect the LiNX LE System Power Module to the batteries.

Do not turn on the wheelchair yet.



Warning:

Do not connect the positive terminal (B+) of the battery to the LiNX LE System Power Module until the wheelchair is completely wired and ready for testing as described in the Testing section.

6. Lift the wheelchair off the ground and check the installation thoroughly.
7. Program the system to the requirements of a particular wheelchair or user.
8. Test the system for functionality and safety.

2.1.1 Power up / down



Note:

In the unlikely event that the wheelchair is in a runaway situation, the user can press the Remote's power button to perform an EMERGENCY STOP. See section 2.1.2 Emergency stop



Figure 14:
Power OFF

To switch ON the LiNX LE System, press the Power button. The Power button is the only user input that can activate the system.

If the system is healthy, the Status indicator (through the Power button) will light up green, and the Battery Gauge will display the current battery status.

If there is a fault with the system when powering up, the status indicator will indicate the fault with a series of red flashes (see section 3 Diagnostics). If the fault is one that prevents the system from driving, then the battery gauge will flash continuously.



Figure 15:
Power ON

To switch OFF the system, press the Power button; the system will power down and the Status indicator will switch off.

The Power button is also used to perform an EMERGENCY STOP. See next section.



See also:

2.1.9 The status indicator on page 13

2.1.2 Emergency stop

If the user needs to stop the wheelchair quickly, the Power button can be pressed to perform an EMERGENCY STOP. The wheelchair will come to a halt quickly; the rate is set by the Emergency Deceleration parameter.



See also:

If this parameter is set too high, the user can lose balance or fall out of the chair.

2.1.3 Drive inhibit indication

Drive inhibit mode is indicated by the battery gauge with a right-to-left chase sequence.

The chase sequence starts with the green LED on the right-hand side, and one-by-one, each LED will switch on and then off. When the sequence completes at the left-most red LED, it begins again at the right-hand side.

The chase sequence continues until the error condition has been cleared.

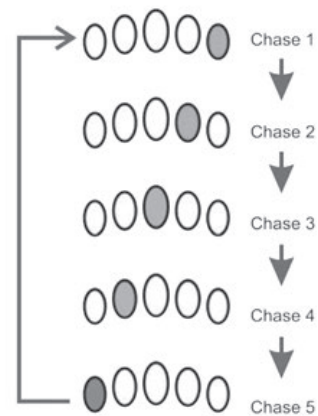

Figure 16: Drive inhibit chase sequence

2.1.4 OONAPU

OONAPU ("Out Of Neutral At Power Up") is a safety feature that prevents accidental movement of the wheelchair, either when powering up, or when the wheelchair comes out of an inhibit state.

If the LiNX LE System is turned on (or comes out of an inhibit state) while the joystick is not in the centre position, an OONAPU warning is displayed. During an OONAPU warning, the battery gauge LEDs will flash continually to alert the user, and the chair will not drive. If the joystick is returned to the centre position within five seconds, the warning will clear and the wheelchair will drive normally.

However, if the joystick remains out of neutral for longer than five seconds, an OONAPU error will occur; the error is displayed by the Status indicator flashing red, and the chair will not drive. To clear the error, return the joystick to the neutral position and power the unit off and then on again.



See also:

3 Error indication See page 15

2.1.5 The joystick



Figure 17: The joystick

The joystick controls the direction and speed of the wheelchair.

When the joystick is deflected from the centre position, the wheelchair will move in the direction of the joystick movement.

The speed of the wheelchair is proportional to the joystick deflection, so that the further the joystick is moved from the centre position, the faster the wheelchair will travel.

2.1.6 Controlling maximum speed

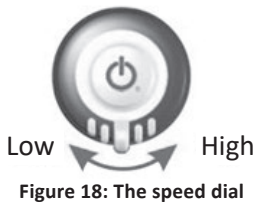

The speed dial allows the user to limit the maximum speed of the wheelchair (that is, the speed when the joystick is fully deflected) to suit their preference and environment.



The dial offers 10 discrete steps between the lowest speed (dial set to the left) and the highest speed (dial set to the right).

As a visual reminder, a speed symbol (shown left) is positioned just below the speed dial to indicate the low and high positions of the speed dial.



Warning:
It is the responsibility of the wheelchair manufacturer to inform the wheelchair user about the wheelchair's stopping distances.

2.1.7 The horn



The Horn button is located above the Power button. Press the Horn button to sound the horn. The horn will sound for as long as the Horn button is pressed.

2.1.8 The battery gauge

The battery gauge comprises five different LEDs (1 x RED, 2 x AMBER, 2 x GREEN), situated above the Remote's Horn button. The number of LEDs lit depends on the status of the battery, as shown below.

The battery gauge LEDs are also used to display charging information. See section 2.2 Battery charging for more details.



2.1.8.1 Normal operation

Battery Gauge	Battery Level	Notes
	Fully charged	This level is set by the Batt Gauge Maximum parameter.
	Consider charging battery	
	Battery needs charging	This level is set by the Batt Gauge Minimum parameter.

Figure 22: Battery gauge operation

2.1.8.2 High voltage warning



Figure 23: High voltage warning

A high voltage warning is indicated by all LEDs on, and the green LEDs flashing. This occurs when the battery voltage level has risen above the high voltage warning set-point.

2.1.8.3 Low voltage warning



Figure 24: Low voltage warning

A low voltage warning is indicated with the left-most LED flashing. This occurs when the battery voltage level has decreased below its low voltage warning set-point.

Charge the battery immediately.

2.1.8.4 Cut-off voltage



Figure 25: Cut-off voltage

When the battery voltage decreases below the battery cut-off voltage:

- the first (red) LED will flash on the battery gauge
- the status indicator (under the power button) will display a flash code 2 or 7
- the horn will sound once every 10 seconds

2.1.9 The status indicator



The status indicator is located underneath the power button. When the LiNX LE System is not powered up, the status indicator is not lit.



When the LiNX LE System is powered up, and there are no faults with the system, the status indicator will be lit green.



If, when powered up, there is a fault with the system, then the status indicator will flash red. The number of flashes will indicate the type of error. For flash codes.

Figure 26: The status indicator



See also:

3 Error indication on page 15

2.1.10 The XLR charger connector



The XLR charger connector, which is located on the right-hand side of the Remote, is used to connect to either a battery charger or the LiNX Access Key.

Figure 27: The XLR charger connector



See also:

2.2 Battery charging on page 15



Warning:

Make sure that the battery charger that is used with the vehicle has a drive inhibit function that is correctly connected for use with the controller. The maximum voltage on the inhibit pin must not exceed 3V if a battery voltage is to be detected when the battery charger is connected. If you are not sure, ask your dealer or vehicle manufacturer.

The XLR charger connector on the Remote is to be used exclusively for the intended purpose. Warranty will be voided if any unauthorised device is connected to this port.

2.1.11 The LiNX Communications Bus connector



Figure 28: The LiNX Communications Bus connector

The LiNX Communications Bus connector can be found on the lower front of the Remote (see Figure 28: The Remote: user interface and connectors). The LiNX Communications Bus loom plugs directly into this socket, providing the Remote with both power and communication to the power module.¹

2.2 Battery charging

Plug the battery charger into the Remote's XLR socket.

The Battery Gauge will indicate the system is being charged by cycling between a left-to-right chase sequence, and then displaying the approximate battery charge state at the end of the chase sequence.

Driving is prevented (inhibited) while the system is being charged.

The LE system does not have to be powered up when charging the battery, however, if it is not powered up, then the battery gauge will not display the charging state/ chase sequence.

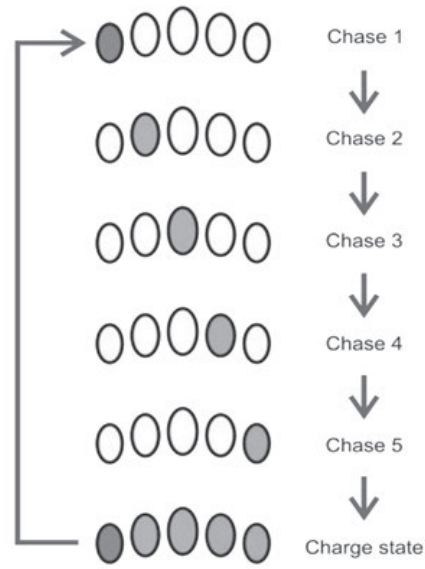

Figure 29: Battery charging chase sequence

Warning:
The maximum charging current for the LiNX LE System is 6A.

The wheelchair manufacturer must specify an appropriate battery charger for the batteries used in the wheelchair.

The wheelchair manufacturer must also specify the maximum current of any battery chargers to be used with the controller and warn against using battery chargers of higher current ratings.

The battery charger must have over-current protection in the form of a non-resettable fuse.

It is the responsibility of the wheelchair manufacturer to manage the risks of battery over-charging and any related gas emissions.

To protect the wheelchair wiring from over currents while charging the batteries, chargers must have the ability to reduce their current output when electrically shorted.

3 Error indication



Figure 30: The status indicator

If, when powered up, there is an error with the system, then the status indicator will flash red. The number of flashes will indicate the type of error. These are described in the table below.

Flash code	Error description
1	Remote / joystick error
2	Network or configuration error
3	Left motor error
4	Right motor error
5	Left park brake error
6	Right park brake error
7	Module error (other than Remote)

For more information about the error, and what to do about it, open the logs within one of the programming & diagnostic tools.

DISASSEMBLING / RE-ASSEMBLING YOUR POWER CHAIR

Taking apart your power chair enables you to save space when keeping it in storage or carrying it along in your vehicle. Having power chair disassembled is easier than ever since no tools are required.

Joystick Cable Removal :

Please follow instructions below to remove joystick cable (M) from armrest.

1. Unplug joystick cable (See Fig. 31).
2. Press lock pins underneath front and along seat sides to unlock, then lift chair up to remove (See Fig. 32) Joystick cable is tied up by 3 cord clips on armrest (See white circle). Remove cable from armrest.

Seat Removal :

1. Fold down seat back.
2. Pull up the seat lock lever (N).
3. Lift up on seat assembly (O) to ensure the seat is secure (See Fig. 32).

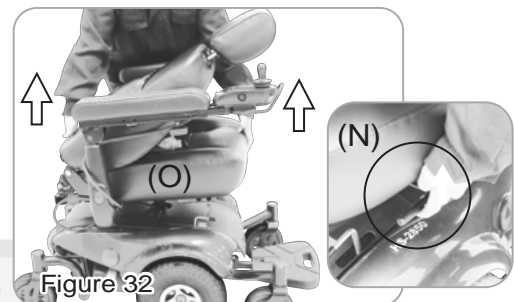
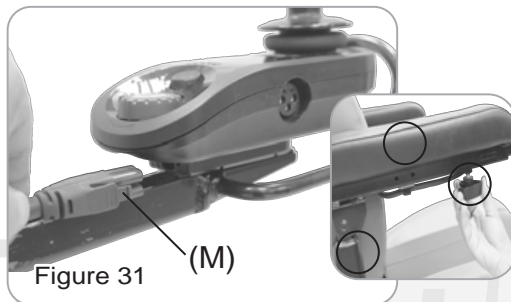

Body Shroud Removal :

1. Remove 3 push rivets (P1) from both front shroud (P) and rear shroud (P2).
2. Follow the arrow's direction to lift up shrouds (See Fig. 33).

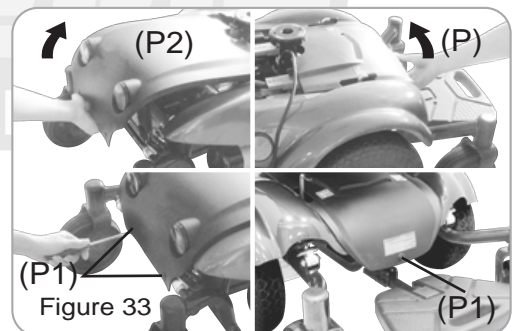

By using a screw driver to pressing down at the center of the push rivet, to release the shroud.

Battery Removal :

1. Disconnect two battery plugs (Q) (See Fig. 34).
2. Unfasten velcro strap that hold batteries in place (See Fig. 35).
3. Remove two batteries (S) (See Fig. 36).

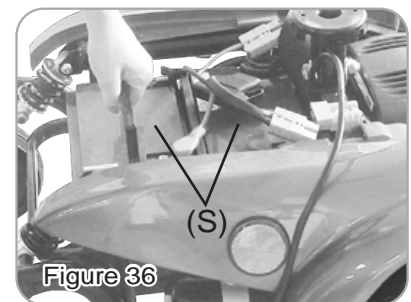
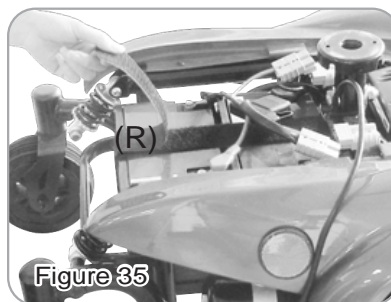
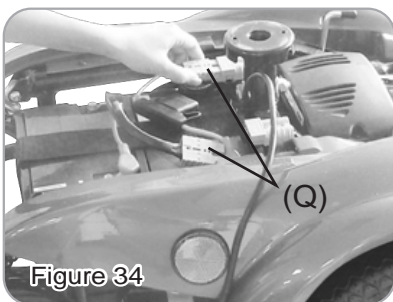

Be careful when carry the batteries as they are heavy. DO NOT connect the Positive (+) to the Negative (-) battery terminal by any conductive metals.

Re-assemble :

To re-assemble your power chair, you can repeat disassembly directions in reverse.

CHARGING THE BATTERIES

Your Ewheels Medical power chair is equipped with two, service free 12V.36Ah rechargeable batteries and one 24V/5A off-board charger. Batteries must be charged before using power chair for the first time and it is recommended to be charged up to 8 - 14 hours after each day's use. Be sure power switch is in OFF position and free-wheeling lever is in "D" position.

Charging the batteries :

- 1.Position EW-M48 power chair next to a standard wall outlet.
- 2.Insert the the battery charger cord into the chair input battery charging socket, which is located on the front of the joystick.
- 3.Plug the other end of power cord into a standard electrical wall outlet.
- 4.Switch the charger power On.

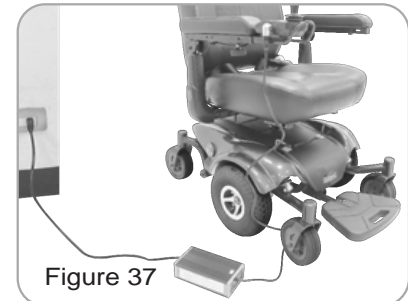

Figure 37

During the recharge :

While the batteries are being recharged, a orange light appear on the battery charger, indicating that the power is connected and charging is in progress.

At the end of the recharge cycle :

- 1.A green light will appear on the charger. This indicates that the batteries are fully charged and ready for use.
- 2.Please unplug power cord from wall outlet and power chair. The power cord should be stored in a safe and dry area until next use.



If charging your power chair for over 8 - 14 hours and it does not function, please check :

- fuse is not burned out
- power chair is turned off
- circuit breaker is pushed in
- if none of above is the problem, contact your authorized dealer.

The time needed to recharge will vary depending on depletion of batteries. Charging for longer than necessary will not harm batteries. They cannot be overcharged.

For safety, please follow the guidelines below :

- 1.DO NOT use the charger if the power cord is damaged.
- 2.DO NOT use an extension cord when charging your batteries.
A risk of fire and/or electric shock could be encountered.
- 3.DO NOT take apart the charger, as this will void the warranty.

Keep in mind these rules :

- Fully charge batteries at least once a month, or more if you use power chair regularly. Charge after each trip exceeding 3 kilometers.
- If storing your power chair for some time (1 month or more), make sure that batteries are fully charged, and on returning, charge them again before using power chair.
- Batteries will only give maximum performance after power chair has been used, and batteries have been recharged up to 10 times. A bit like breaking in a new car.

Please be aware that the travelling range of your power chair is impacted by how fast the batteries are discharged. This will depend on many circumstances, such as ambient temperature, condition of the surface of the road, tyre pressure, weight of the driver, driving environment (inclines etc.) and utilisation of your lighting system if fitted. We recommend that you test your local ride with a family member to ensure a safe journey.

CARE AND MAINTENANCE

Taking care of your power chair will keep it in top-notch condition. It is recommended that you have your dealer to provide a thorough inspection and servicing. Regular cleaning will reveal loose or worn parts and enhance the smooth operation of your powered scooter. Routine maintenance will extend the life and efficiency of your power scooter.

BODY SHROUD :

If your power chair is dirty, use a damp or lightly soapy cloth to wipe it down. Do not use running water to wash or rinse power chair in order to protect electrical parts. Polish with an automotive liquid polish.

SEAT AND ARMRESTS :

The seat material used by Ewheels Medical is of high quality and will remain in good condition for many years if treated responsibly. Using a damp cloth helps clean the upholstery greatly. Please note that using power chair outdoors could lead to sun damage to upholstery material, and normal wearing and tearing is not covered under warranty.

SEAT BELT :

A damp cloth with mild soapsuds should only be used to clean seat belts. Wipe seat belts gently and remove residue. Do not use any chemical products to clean seat belts as fabric will be weakened.



An authorized dealer should handle all maintenance and repair associating with electronics, batteries, motor parts, and tires. Here are the guidelines that can be followed by authorized dealer.

FLAT SPOT (for solid tires only) :

During storage period, a flat spot may occur to solid tires. Weather conditions and storage period determine the condition of flat spots. By driving power chair 20 to 30 minutes, flat spots could be eliminated.

TIRE PRESSURE (for air-filled tires only) :

The condition of tires and maintenance of specified tire pressures not only influence tire life, but also effect road safety to a very considerable extent. Incorrect pressure is often a cause of tire problems and could result in an accident. The recommended tire pressure is 35 psi.

TIRE TREAD :

Inspect the tires frequently for any signs of damage, such as unusual wearing or insufficient tread depth. Tread depth should not be allowed to drop below 1 mm.

ELECTRICAL CONNECTIONS :

Make sure battery terminals and all plug connectors are secured and firmly attached. If battery terminals are corroded, please contact your dealer for replacement.

HARDWARE :

Check that all hardwares and are securely fastened. Replace any missing hardware by contacting your dealer.

STORING :

Also between uses, your power chair is best stored in a dry location at room temperature.

Other Problems :**• Power chair will not move when power is turned on :**

1. Check Battery Gauge on joystick. All LED lights should be on.
 2. Check Self-Diagnostic Warning Light. It should be steady; if it is flashing, see the chart on page 16 for problem identification.
 3. Check all electrical connections to be sure they are tight.
 4. Make sure batteries are connected correctly. Refer to "Installation of Batteries" on page 17.
 5. If none of above correct problem, contact your authorized dealer.
- If charging your scooter for over 14 hours and light on charger does not change to green, then contact your authorized dealer.



SPECIFICATION

Overall Length	39"
Overall Width	24"
Overall Height	42.5"
Front Wheels	6"
Middle Wheels	10"
Rear Wheels	6"
Weight W/ Batteries	181 lbs
Max. Speed	4.2 mph
Weight Capacity	300 lbs
Ground Clearance	2.4"
Grade Climbable	6 degree
Curb Climbable	1.8"
Turning Radius	24.4"
Suspension	Front, Rear & Center
Brake	Electro-Mechanical
Seat Type	Captain Seat W/ Headrest, Adjustable Seat Height, & Seat Belt
Seat Width	20"
Drive Train	2-Motor Mid-Wheel Drive
Motor Size	420W, 4900 r.p.m
Battery Size	(2) 12V. 36Ah
Weight of Battery	49.6 lbs
Travel Range	12.4 Miles
Battery Charger	5A Off Board

*Subject to change without notice. (Rev. 0, 2020/03/23)

Warranty- Medical Scooters

Models Included

EW-M33, EW-M34, EW-M35, EW-M39, EW-M40, EW-M41, EW-M43, EW-M45, EW-M48, EW-M49, EW-M50, EW-M81, EW-M82, EW-M83, EW-M91, EW-M92, EW-M93.

Three Year Limited Warranty

Three (3) years from the date of purchase on all structural frame components, seat post and frame.

One Year Limited Warranty

One (1) Year from the date of purchase, if any part or electronic component of the scooter is found upon examination to be defective in material and/or workmanship, it will be replaced at Ewheels discretion.

Six Month Warranty

Six (6) Months from the date of purchase on the batteries and charger. Batteries are subject to a stringent wear and tear clause. Any battery faults due to a manufacturing defect will become obvious within the first two months of use. Any gradual deterioration in performance after this period is normal and associated with fair wear and tear, misuse or accidental damage and as such is not covered by the manufacturer's warranty.

WARRANTY EXCEPTIONS AND EXCLUSIONS

Service and Labor Costs

Unless previously authorized, service calls and labor costs are NOT included or covered under any warranty. The purchaser is responsible for the delivery to the authorized repair facility. Satisfactory proof of purchase is always required for warranty service. Please contact Ewheels directly for any assistance in locating a service provider or to make a warranty claim.

Consumable Items

Consumable items which may need replacing due to normal wear and tear like tires, tubes, lights, chains, upholstery and seating, brakes and brake pads, cables, fuses, buttons, shrouds and covers.

Damage, Accidental Damage and Misuse

Damaged caused by: battery fluid spillage or leakage, abuse, misuse, accident, negligence, improper operation, excessive loading, maintenance, storage, acts of God, commercial use, or use other than normal, extreme riding, modifications and alterations.

Second Hand Owners and Reselling

No warranty will be offered or honored for second hand owners. The warranty is exclusively offered to the original purchaser.

HOW TO MAKE A WARRANTY CLAIM

Initiating A Warranty Claim

To initiate a warranty claim, please contact Ewheels service department by calling 888-571-2845, or by email at "Service@ewheelsdealers.com". Note that before any warranty claims will be fulfilled, satisfactory proof of purchase will be required, and a photo or video of the damaged part must be sent and reviewed by Ewheels.

Returning Faulty Parts

Do not return faulty parts to Ewheels without prior consent. A request for a return authorization is required prior to returning items. All transportation costs and shipping damage incurred while submitting units and/or parts for repair or replacement are the responsibility of the original purchaser.

SHIPPING DAMAGE AND SHIPPING POLICIES

Shipping Damage

In the event shipping damage occurs, it must be reported and addressed in a timely manner. Shipping damage claims are time sensitive and cannot be delayed. In the event the packaging is extremely damaged and the bike is beyond repair, please refuse the shipment, and contact Ewheels for further steps.

Shipping – Domestic

When applicable, part costs will be covered under warranty, and all warranty items will be shipped via FedEx Ground. Shipping fees will be at the expense of the purchaser.

Shipping – International

When applicable, parts will be provided under warranty at no charge, but shipping to any offshore and/or international location will be the responsibility of the original purchaser. International and offshore end-users must contact Ewheels directly to initiate the warranty process.

※ Implied warranties, including those of merchantability and fitness for a particular purpose, are limited to one (1) year from the date of the original purchase and to the extent permitted by law. Any and all implied warranties are excluded. This is the exclusive remedy. Liabilities for consequential damages under any and all warranties are excluded※