

ITEM NO.	P/N	Description	QTY.
1	BKSH-2AD	BRACKET	2
2	GLRT-16	GLASS	2
3	CARD-1	END CAP	2
4	CARD-58	LOCK	2
5	TU12-6	TUBE	2
6	TU12-3	TUBE-BOT	2
7	TU38-13.5	TUBE-HOR	1
8	HBBTT-78	HUB	2

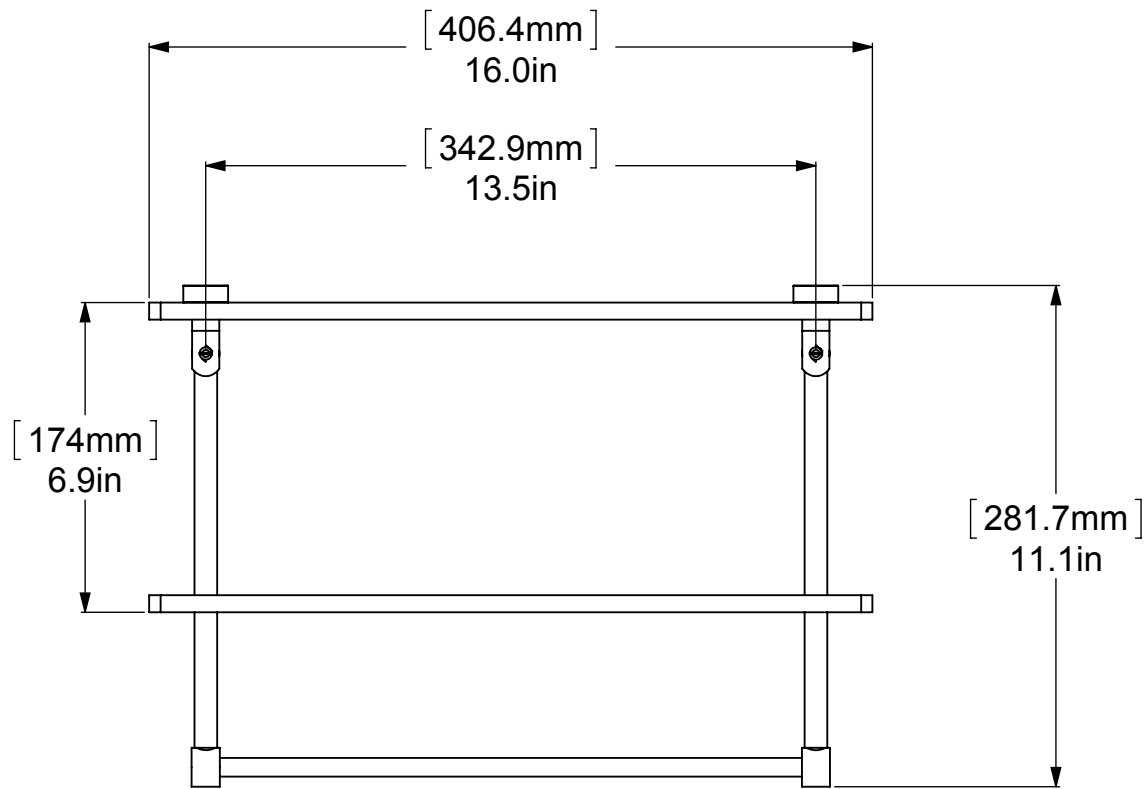
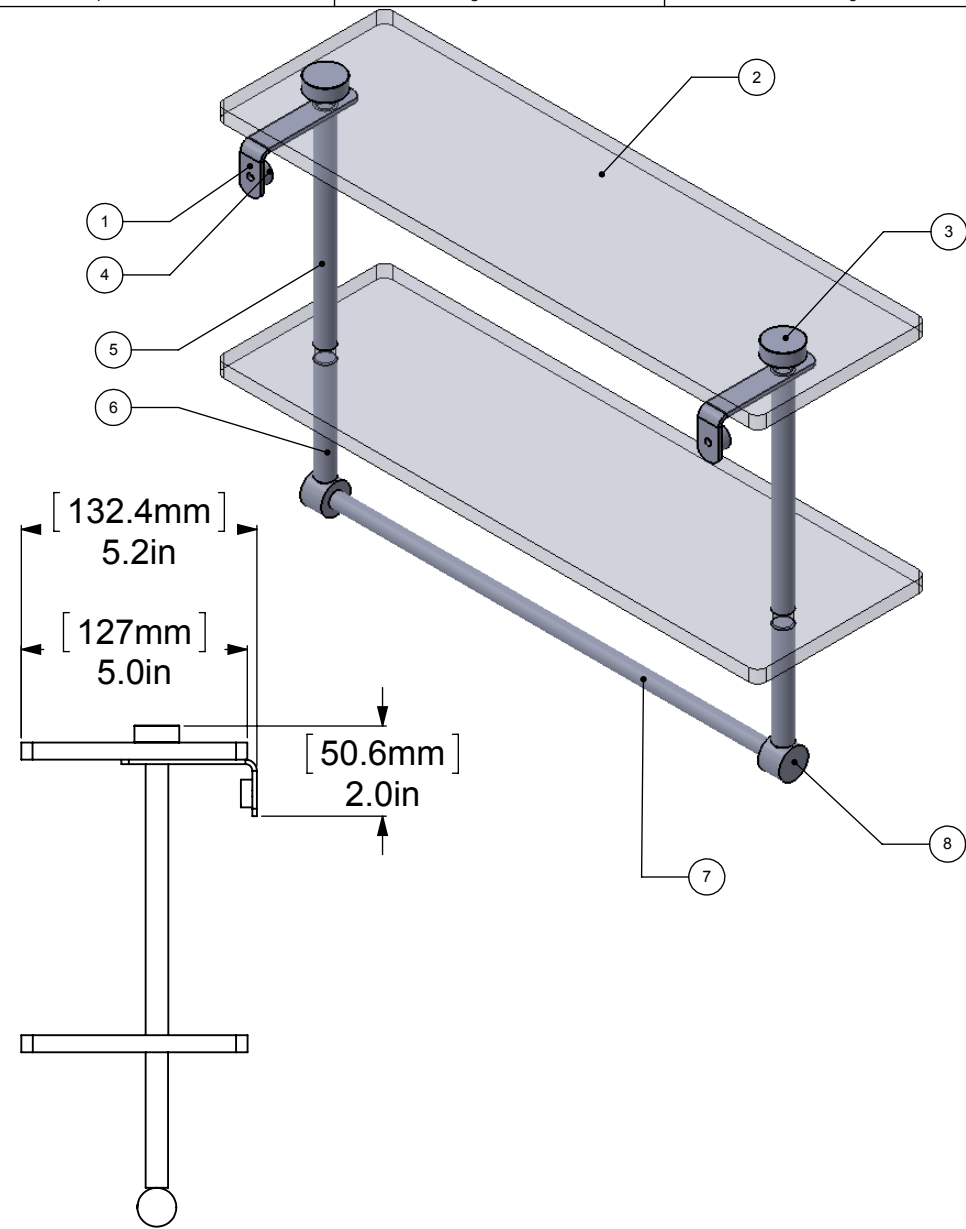

UNLESS OTHERWISE STATED

.X	±.3mm
.XX	±.15mm
.XXX	±.008mm

COPYRIGHT © Allied Brass 2016

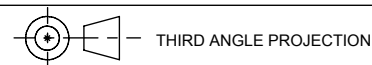

DRAWN	6/28/2016	I.M
CHECKED	6/28/2016	P.D
APPROVED	6/28/2016	R.A

MATERIAL:	BRASS
DESCRIPTION:	SHELF



FINISH	TBD
QUANTITY	TBD
DRAWING No.	REV
NS-2-16TB	0
SCALE	1:4.25 SHEET: 01 A4