

ITEM NO.	P/N	Description	QTY.
1	BKSH-2AD	BRACKET	2
2	GLRT-22	GLASS	3
3	MA-FT	END CAP	2
4	CARD-58	LOCK	4
5	TU12-6	TUBE SUPPORT	4

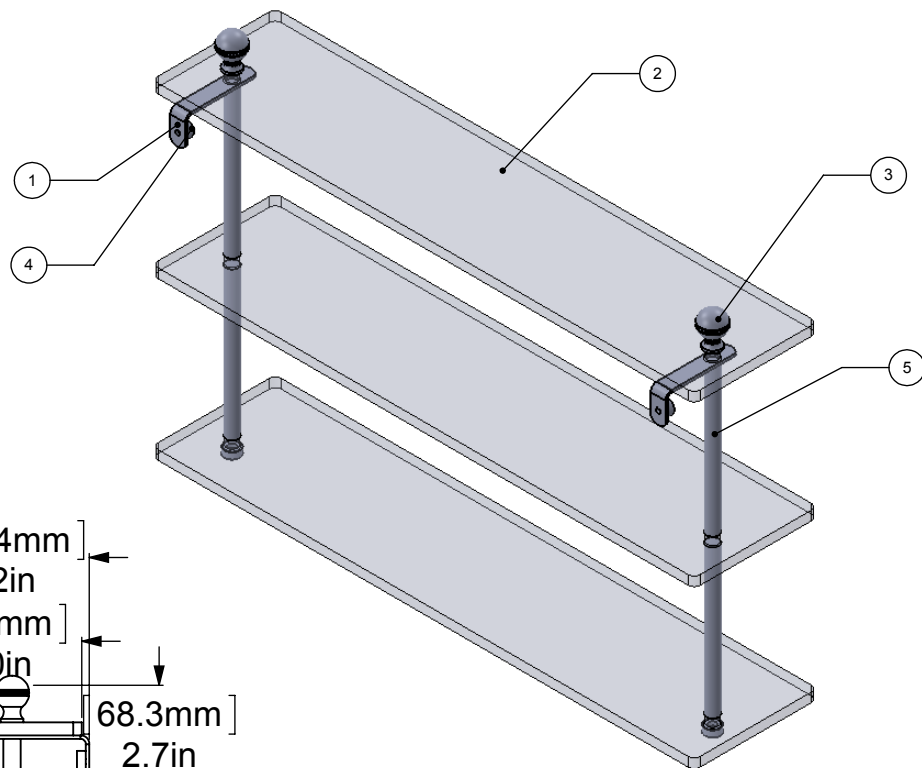
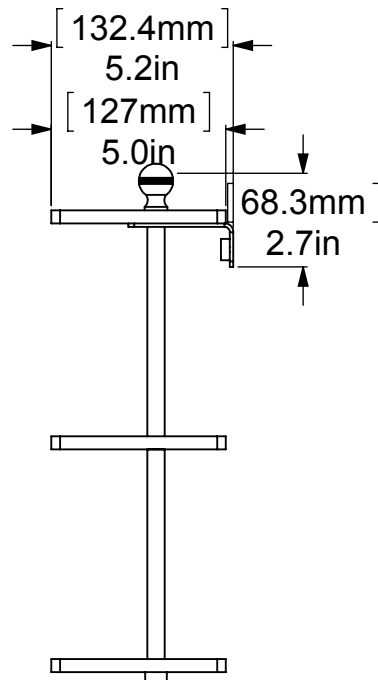
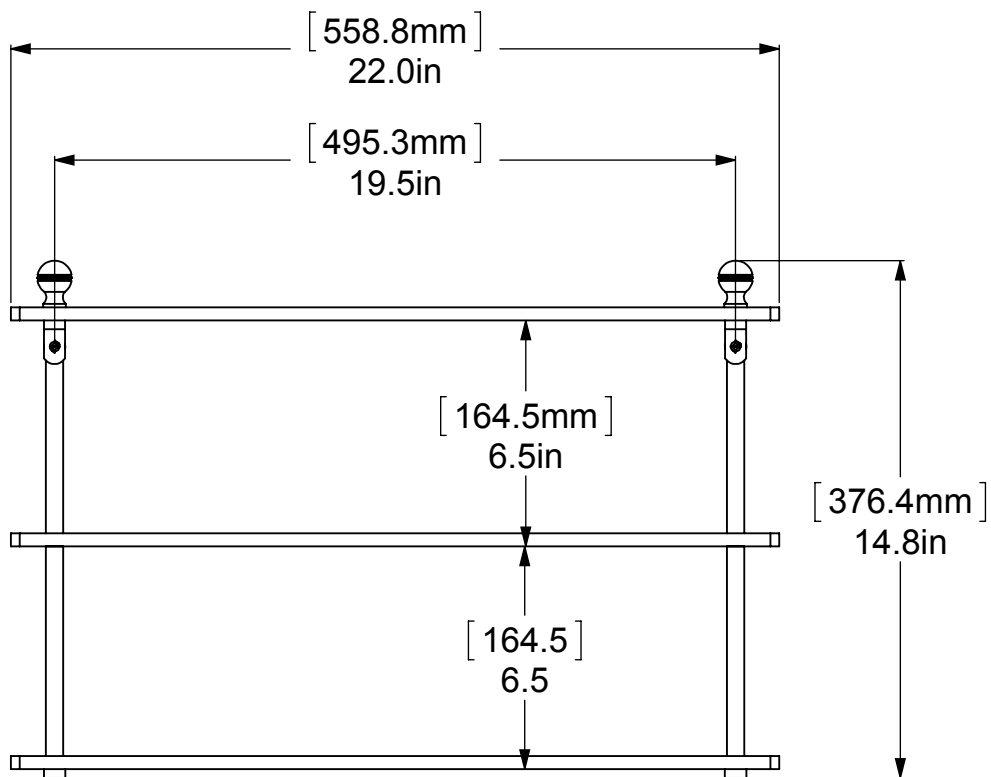

UNLESS OTHERWISE STATED

.X	±.3mm
.XX	±.15mm
.XXX	±.008mm

COPYRIGHT © Allied Brass 2016

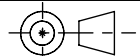

THIRD ANGLE PROJECTION

DRAWN	7/9/2016	I.M
CHECKED	7/9/2016	P.D
APPROVED	7/9/2016	R.A

MATERIAL:	BRASS		FINISH	TBD
DESCRIPTION:	SHELF		QUANTITY	TBD
			DRAWING No.	
			MA-5-16	
SCALE		1:5.5	SHEET: 01	A4