

ITEM NO.	PART NUMBER	DESCRIPTION	QTY.
1	BSK-175LA-COMP	BASKET	1
2	CARD-58	CAP	2

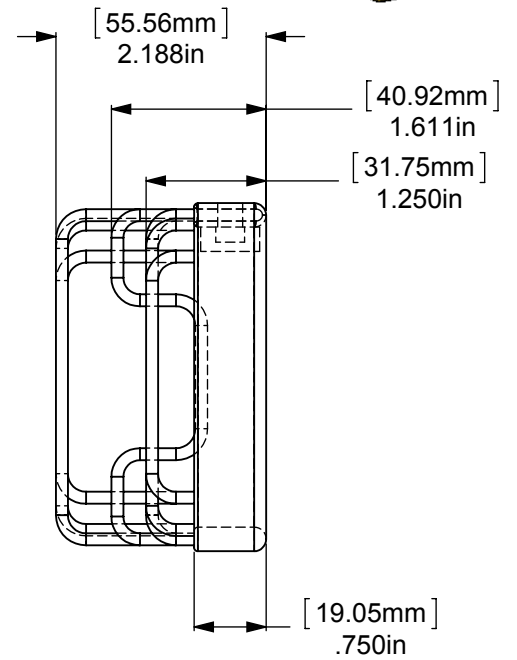
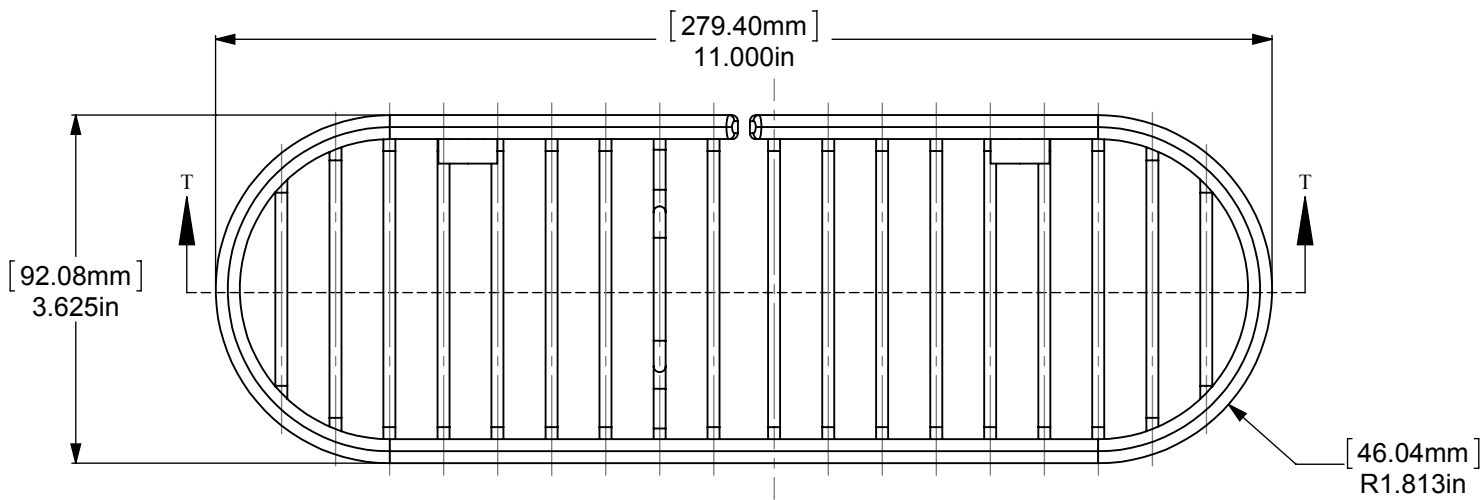
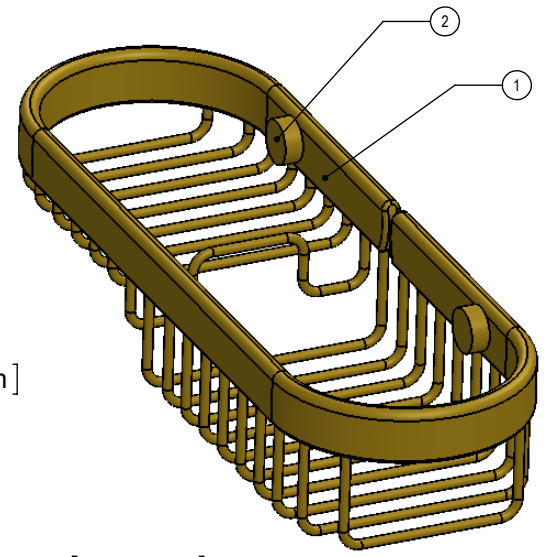
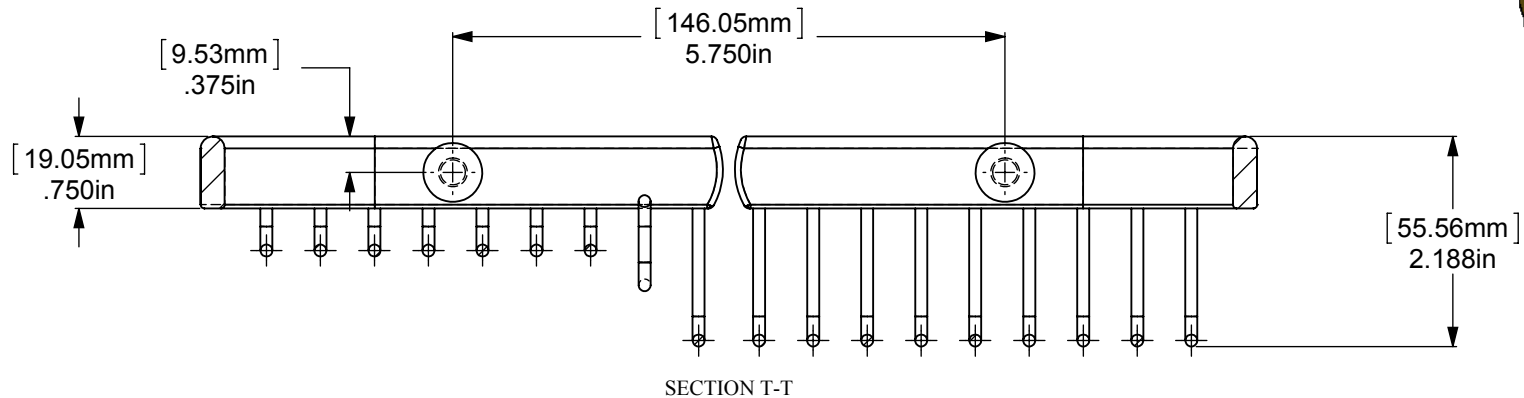

UNLESS OTHERWISE STATED

.X	±.3mm
.XX	±.15mm
.XXX	±.008mm

COPYRIGHT © Allied Brass 2016

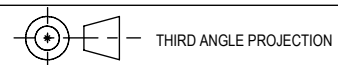

DRAWN	2-10-2016	I.M
CHECKED	2-10-2016	P.D
APPROVED	2-10-2016	R.A

MATERIAL: BRASS
DESCRIPTION: SHOWER BASKET



FINISH	TBD
QUANTITY	TBD
DRAWING No.	REV
BSK-175LA	0
SCALE	1:2 SHEET: 01 A4