

ITEM NO.	P/N	Description	QTY.
1	BPRD	BACKPLATE	1
2	TU12-2	TUBE	1
3	BL2T-1	BALL	1
4	HRRTS	TUB	1

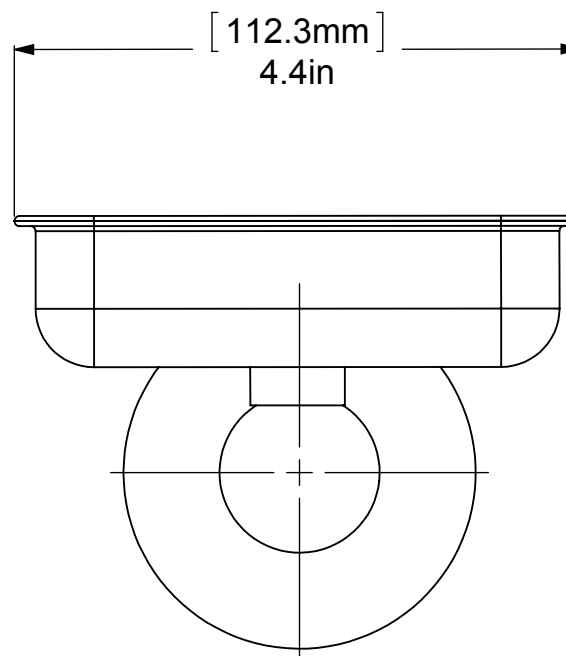
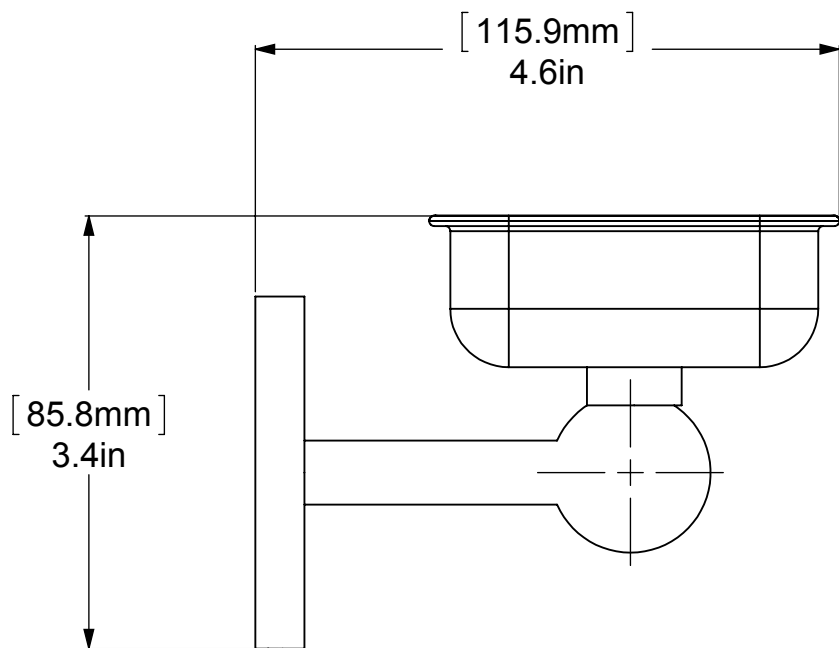
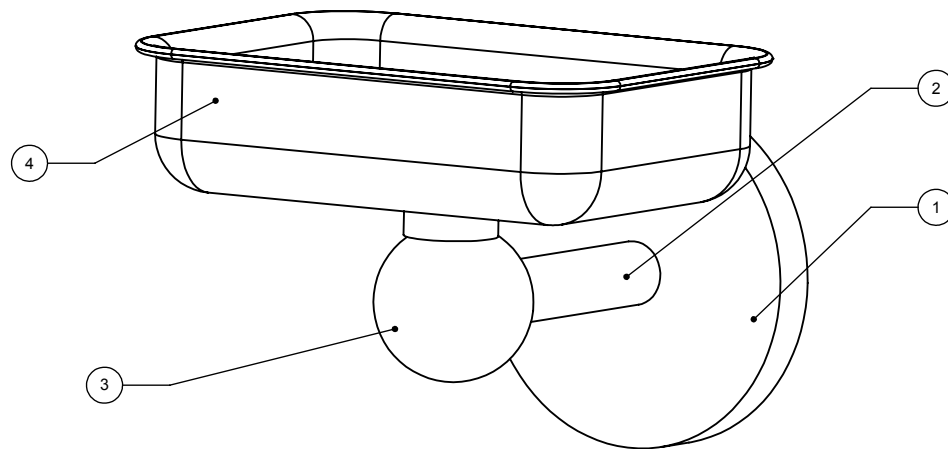

UNLESS OTHERWISE STATED

.X	$\pm .3\text{mm}$
.XX	$\pm .15\text{mm}$
.XXX	$\pm .008\text{mm}$

COPYRIGHT © Allied Brass 2017

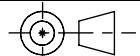

THIRD ANGLE PROJECTION

DRAWN	6/30/2017	I.M	MATERIAL:	BRASS	FINISH	TBD
CHECKED	6/30/2017	P.D	DESCRIPTION:		QUANTITY	TBD
APPROVED	6/30/2017	R.A	SOAP DISH		DRAWING No.	REV
					1032	0
				SCALE	1:1.5	SHEET: 01 A4