

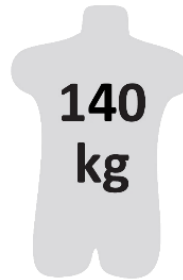

Helixon-S



①



②



③



④





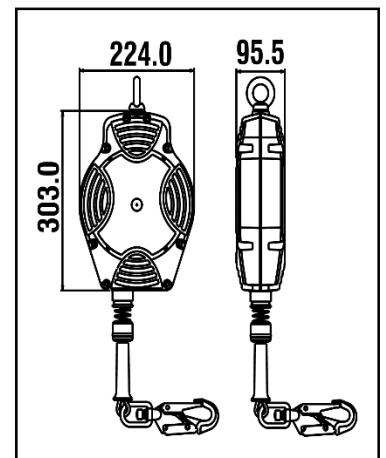

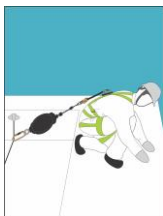
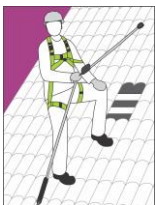

⑤



HS CODE
84798997







REF.	FA 20 402 15
LG.  KG	15 m
CE	EN 360:2002
MAT. 	Polyamide 6 - 30% fiber glass
	STEEL Ø4.8 mm STEEL FA 50 101 17 / FA 50 203 20 with fall indicator
	x2
R(kN)	12 kN
	YES PPE-R/11.060
+	VG11.060
	8.01 KG

LG.

KG
Length Max. user weight

MAT.

Material of casing / wire rope

Material of top connector / bottom connector

Number of swivels

Approved for work near sharp edges